



The right vertical solution for any situation.

Bring Wire & Cable Down to Business

Routing power, data, and A/V – neatly and simply – from up there to down here; that’s what Tele-Power® Poles are all about. Their sole purpose is to get the business end of your wire and cabling needs down to your workstation, equipment, or modular furniture. Specifically, in away-from-the-wall locations in open commercial office areas, schools, labs, stores and other sites.

Whatever power, data, or A/V wiring you need to bring down to the desk, workstation, or cash registers, Wiremold Tele-Power Poles handle all of your needs effortlessly. For modular office furniture – our poles easily provide the hook up to feed office partitions. The poles are also available with specialized electrical circuits such as dedicated/isolated ground. Vertical drop poles give you the flexibility and capacity to devote both sides of the pole for single or dual service feeds. Legrand/Wiremold offers the broadest selection of open space solutions. With standard, custom and configurable products, you can rest assured that the right solution is readily available and adaptable to your current and future work environments.

Features & Benefits

- **Promotes sustainable design.** Allowing services to be routed to the center of an open space rather than by building a wall increases the use of natural daylight and reduces energy consumption.
- **Bring power, data, and A/V services into open space environments quickly & easily.** Easy to install. Reduces costs for moves, adds and changes.
- **Wide selection of standard options.** Stocked in a variety of materials, finishes, sizes, and device configurations. Provides what you want, when you need it.
- **Relocatable.** Ready for service in 30 minutes or less. Can be quickly reconfigured or relocated as work space uses and service needs change.
- **Dual-channel.** Allows a single drop point for access to multiple services.
- **Accessory packs included.** Furnished with feed fittings, ceiling trim plates, T-Bar mounting hardware, and carpet/floor grippers. Everything you need for a complete and stationary installation accommodating a variety of installation scenarios.
- **Multiple color options.** Available in four aesthetic colors: white (WH), black (BK), ivory and gray (DG) and aluminum (AL).
- **Custom capabilities.** Modify receptacle type and location, change color finish, alter pole heights, add fixture whips and more. Affording you more choice in appearance and configuration.
- **On-site configurability.** In-field modifications, including adding devices and changing the height, make Tele-Power poles even more flexible.
- **A/V Compatibility.** 30TP Series are now compatible with A/V devices to allow for a full range of services to your work stations.
- **Datacom connectivity options.** Accepts industry standard and proprietary devices from a wide range of manufacturers to provide a seamless, aesthetically pleasing interface for voice, data, audio, and video applications at the point of use.
- **New TPP-E Series Tele-Power Pole Extenders combine quick installation with easy job-site handling.** Snap together 5' sections to create a pole or extend the length of your existing 25TP & 25DTC Series poles. These new extenders accommodate a variety of ceiling heights, can ship UPS or air freight for quick & reliable delivery.

Vertical Markets

- Commercial
- Education
- Retail



Download this product's PEP ecopassport® environmental product declaration at www.legrand.us/resources-and-downloads. This declaration conforms with ISO 14025 and 14040 and is in alignment with EN 15804.

Compliance



cULus Listed, Multioutlet Assemblies: File E15191, E178348. Guide RJPR. Meets Articles 380 & 386 of NEC
Raceway Fittings: File E41751. Guide RJPR
Accessories: File E53857, Guide RVUR.

Field Modifications for Tele-Power Poles

MODIFICATION	TELE-POWER POLE SERIES									
	30TP-4V	30TC-4V	30TP-2V	30TC-2V	25DTP-4	25DTP-4D	25DTC-4	AMDTP-4	AMDTP-4D	AMTC-4
Can the receptacles in the standard pole be rewired in order to have a two circuit pole with standard duplexes?	Yes	N/A	Yes	N/A	No	Yes	N/A	No	Yes	N/A
Can the receptacles in the standard pole be replaced with other types? (i.e. Hospital Grade, TVSS, GFCI, etc.)	Yes – Using the proper device cover	N/A	Yes – Using the proper device cover	N/A	Yes – with 2507C Bracket & only with NEMA duplex receptacles	Yes – Only with NEMA duplex receptacles	N/A	Yes – With 2507C Bracket & only with NEMA duplex receptacles	Yes – Only with NEMA duplex receptacles	N/A
Can receptacles be added to blank poles?	N/A	Yes	N/A	Yes – Using the proper device cover	N/A	N/A	Yes – With 2507C Bracket	N/A	N/A	Yes – With 2507C Bracket
Can blank poles be used for furniture feed applications by field punching KOs on poles for power and voltage?	N/A	Yes	N/A	Yes	N/A	N/A	Yes	N/A	N/A	Yes
Can more than one add-on device cover be used?	N/A	N/A	N/A	N/A	Yes	Yes	N/A	Yes	Yes	N/A
Can receptacles be installed in both sides of the pole?	Yes – Power only on both sides	Yes – Power only on both sides	N/A	N/A	No	No	No	No	No	No
Can poles be field cut for use in lower ceiling applications?	Yes*	Yes*	Yes*	Yes*	Yes*	Yes*	Yes*	Yes*	Yes*	Yes*
Can poles be mounted to hard or open ceilings?	Yes**	Yes**	Yes**	Yes**	Yes**	Yes**	Yes**	Yes**	Yes**	Yes**

* Review instruction sheet for instructions for cutting poles.

** Pole housing cannot be penetrated. Ceiling mounting hardware must provide firm support and must be supplied by installer.

NOTE: All receptacles, additions, rewiring and other electrical modifications must be made by a qualified electrician in accordance with the NEC or other applicable local codes and adhering to the wire fill capacity charts for the respective pole.



Specially-designed Tele-Power Poles can be fitted with lighted signage while also bringing power and data to cash wraps and counter areas, or used to feed services to display cases, photo kiosks and price check stations.

Steel Tele-Power Poles

Steel Tele-Power Poles are the workhorse of vertical wire and cable management solutions. They are available either prewired with electrical devices or as blanks to feed services to other wire and cable management systems, such as electrified modular furniture. As the long time industry standard, steel Tele-Power Poles are available with an ivory enamel finish and are available in a variety of lengths. 25DTP Series Tele-Power Poles are also available in white, gray or black enamel finishes. They also offer the flexibility of field configuration or can be customized to customer specifications.

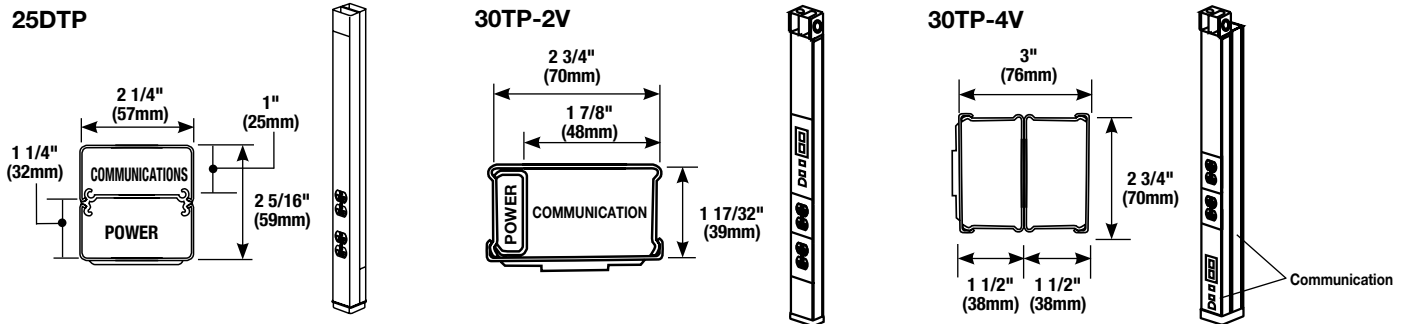

NOTE: For the 25DTP custom colors, other lengths (20' (6.1m) max.) or additional circuits are available on custom orders. Consult factory for more information. Can be factory or field wired with many commercially available devices.
For the 30TP-2V and 30TP-4V custom colors or additional circuits are available on custom orders. Consult factory for more information. Can be factory or field wired with many commercially available devices.

25DTP & 30TP Series Tele-Power Poles Wire Fill Capacities																
CATALOG NUMBER	NUMBER & TYPE OF POWER OUTLETS	POLE HEIGHT		FINISH	Wire Size		Cat 5		Cat 6		RG58/U		RG62A/U		RG6/U	
		Inches	(mm)		#10	#12	0.22" (5.6mm)	0.25" (6.3mm)	0.195" (5.0mm)	0.242" (6.1mm)	0.270" (6.9mm)	20%*	40%**	20%*	40%**	20%*
25DTP-4	Two Duplex Receptacles (20A, 125V)	10' 5"	(3.175m)	Ivory, Gray, White, Black	10	15	10	19	9	17	13	25	8	16	7	13
25DTP-412		12' 5"	(3.780m)		10	15	10	19	9	17	13	25	8	16	7	13
25DTP-415		15' 5"	(4.700m)		10	15	10	19	9	17	13	25	8	16	7	13
25DTP-E10		10' 5"	(3.175m)	Ivory, Gray	10	15	10	19	9	17	13	25	8	16	7	13
25DTP-4D	Two Duplex Receptacles (20A, 125V), One Dedicated/ Isolated & One Standard Branch Circuit	10' 5"	(3.175m)	Ivory, Gray	10	15	10	19	9	17	13	25	8	16	7	13
25DTP-4ACT	Two Duplex Receptacles (20A, 125V), One Communications Insert Mounting Adapter, Three Blank Inserts	10' 5"	(3.175m)	Ivory, Gray	10	15	10	19	9	17	13	25	8	16	7	13
30TP-2V	Two Duplex Receptacles (20A, 125V)	10' 5"	(3.175m)	Ivory	8	12	16	31	13	26	20	40	13	25	10	20
30TP-212V		12' 5"	(3.780m)	Ivory	8	12	16	31	13	26	20	40	13	25	10	20
30TP-215V		15' 5"	(4.700m)	Ivory	8	12	16	31	13	26	20	40	13	25	10	20
30TP-4V	Two Duplex Receptacles (20A, 125V)	10' 5"	(3.175m)	Ivory	30	48	19	37	15	30	24	47	15	30	12	24
30TP-412V		12' 5"	(3.780m)	Ivory	30	48	19	37	15	30	24	47	15	30	12	24
30TP-4V3S2		10' 5"	(3.175m)	Ivory	30	48	19	37	15	30	24	47	15	30	12	24
30TP-412V3S2		12' 5"	(3.780m)	Ivory	30	48	19	37	15	30	24	47	15	30	12	24

* 20% cable fill is calculated to approximate reduction in cable capacity due to connectors mounted within pole section that may restrict cross-sectional areas.

** 40% cable fill is the maximum designed cable fill based on a proposed revision to TIA/EIA 569-A.

Steel Tele-Power Poles Ordering Information

Catalog No./Item	Description/Specifications
25DTP-4 25DTP-4WH 25DTP-4BK 25DTP-4DG 25DTP-412 25DTP-412WH 25DTP-412BK 25DTP-412DG 25DTP-415 25DTP-415WH 25DTP-415BK 25DTP-415DG	<p>Tele-Power Pole – Two-compartment pole (power and communications). Nominal material thickness .040" (0.8mm). Ivory, white, black or gray bootbase. Factory wired with fed-spec general grade 20A, 125V duplex style receptacles. An 8" (203mm) cover at top front of pole is removable for making power wiring connections. KOs provided in removable cover for RJ11/RJ45 and modular furniture communication connectors. Mounting hardware, entrance end plate and two ceiling trim plates furnished. Available in standard lengths of 10' 5" (3.2m) (25DTP-4), 12' 5" (3.8m) (25DTP-412) and 15' 5" (4.7m) (25DTP-415). Also increase the length of any 25 Series pole with the 25DTC-E5 Tele-Power Pole Extender.</p>

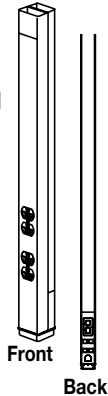

Country of Origin: USA

25DTP-4ACT 25DTP-4ACT-DG	<p>Tele-Power Pole – Tele-Power Pole – Two-compartment pole (power and communications). Nominal material thickness .040" (0.8mm). Ivory, white, black or gray bootbase. Factory wired with fed-spec general grade 20A, 125V duplex style receptacles. An 8" (203mm) cover at top front of pole is removable for making power wiring connections. Provided with 6A bezel which can accept three (3) Wiremold CM2 modules. Three (3) CM2 blank modules are included. Mounting hardware, entrance end plate and two ceiling trim plates furnished. Available in standard length of 10' 5" (3.2m). Also increase the length of any 25 Series pole with the 25DTC-E5 Tele-Power Pole Extender.</p>
---	--

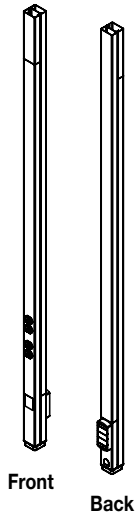

Country of Origin: USA

Catalog No./Item	Description/Specifications
25DTP-4D 25DTP-4D-DG	<p>Tele-Power Pole – Two-compartment pole (power and communications). Nominal material thickness .040" (0.8mm). Ivory, white, black or gray bootbase. Factory wired with one (1) 20A 125V dedicated/isolated ground duplex receptacle and one (1) 20A, 125V standard duplex receptacle. An 8" (203mm) cover at top front of pole is removable for making power wiring connections. KOs provided in removable cover for RJ11/RJ45 and modular furniture communication connectors. Mounting hardware, entrance end plate and two ceiling trim plates furnished. Available in standard length of 10' 5" (3.2m) (25DTP-4D). Also increase the length of any 25 Series pole with the 25DTC-E5 Tele-Power Pole Extender.</p>

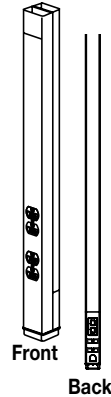

Country of Origin: USA

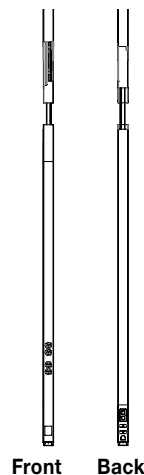

25DTP-E10 25DTP-E10-DG	<p>Steel Express Tele-Power Pole – Two sections of a two-compartment (power and communication) pole (5' 4" [1.626m] base + 5' [1.524m] extender) assembles to form a 10' 4" [3.148m] pole. Nominal material thickness .040" [1.0mm]. Ivory or gray boot base. Factory-wired with fed-spec general grade 20A, 125V duplex style receptacles. An 8" [203mm] cover at top front (power side) of pole is removable for making power wiring connections. KOs provided in removable cover for RJ11/RJ45 and modular furniture communication connectors. Mounting hardware, entrance end plate and two ceiling trim plates furnished.</p>
---	---



Country of Origin: USA

NOTE: Custom colors, custom lengths (20' (6.1m) max.) or additional circuits are available on custom order. Consult factory for more information. Can be factory or field-wired with many commercially available devices.

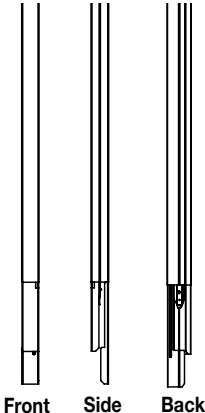
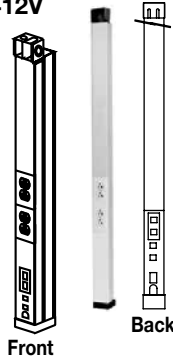
Steel Tele-Power Poles Ordering Information

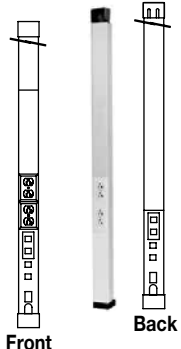
Catalog No./Item	Description/Specifications	Catalog No./Item	Description/Specifications
<p>25DTC-E5 25DTC-E5WH 25DTC-E5BK 25DTC-E5DG</p>  <p>Front Side Back</p>	<p>Blank Steel Pole Extender – Two-compartment extender mounts onto existing 25DTP or 25DTC series pole. Nominal material thickness .040" (1.0mm). Furnished unwired without outlets. Uses existing pole mounting hardware, entrance end plate and ceiling trim plate. Available in 5' (1.524m) length. Can be cut to desired length.</p> <p>Country of Origin: USA</p>	<p>30TP-4V 30TP-412V</p>  <p>Front Back</p>	<p>Tele-Power Pole – Two- 30TP-412V compartment pole (one power; one communication with crossover below power devices). Nominal material thickness .040" (1.0mm). Factory wired with two specification grade 20A, 125V duplex receptacles. Mounting hardware, entrance end fitting, and ceiling trim plate furnished. Available in standard lengths of 10' 5" (3.2m) (30TP-4V) and 12' 5" (3.8m) (30TP-412V).</p> <p>Country of Origin: USA</p>
<p>30TP-2V 30TP-212V</p>  <p>Front Back</p>	<p>Tele-Power Pole – Two- 30TP-212V compartment pole (power and communications). Nominal material thickness .040" (1.0mm). Factory wired with two specification grade 20A, 125V duplex receptacles. Mounting hardware, entrance end fitting, and ceiling trim plate furnished. Available in standard lengths of 10' 5" (3.2m) (30TP-2V) and 12' 5" (3.8m) (30TP-212V).</p> <p>Country of Origin: USA</p>	<p>30TP-4V3S2 30TP-412V3S2</p>  <p>Front Back</p>	<p>Tele-Power Pole – Two duplex 30TP-412V3S2 receptacles (20A, 125V). Provided with a bezel which can accept three (3) Ortronics® Series II inserts. One dual Cat 5e and two (2) blank inserts also included. Available in standard lengths of 10' 5" (3.2m) (30TP-4V3S2) and 12' 5" (3.8m) (30TP-412V3S2).</p> <p>Country of Origin: USA</p>

NOTE: Custom colors or custom circuits are available on custom order. Consult factory for more information. Can be factory or field-wired with many commercially available devices.

Steel Blank Tele-Power Poles

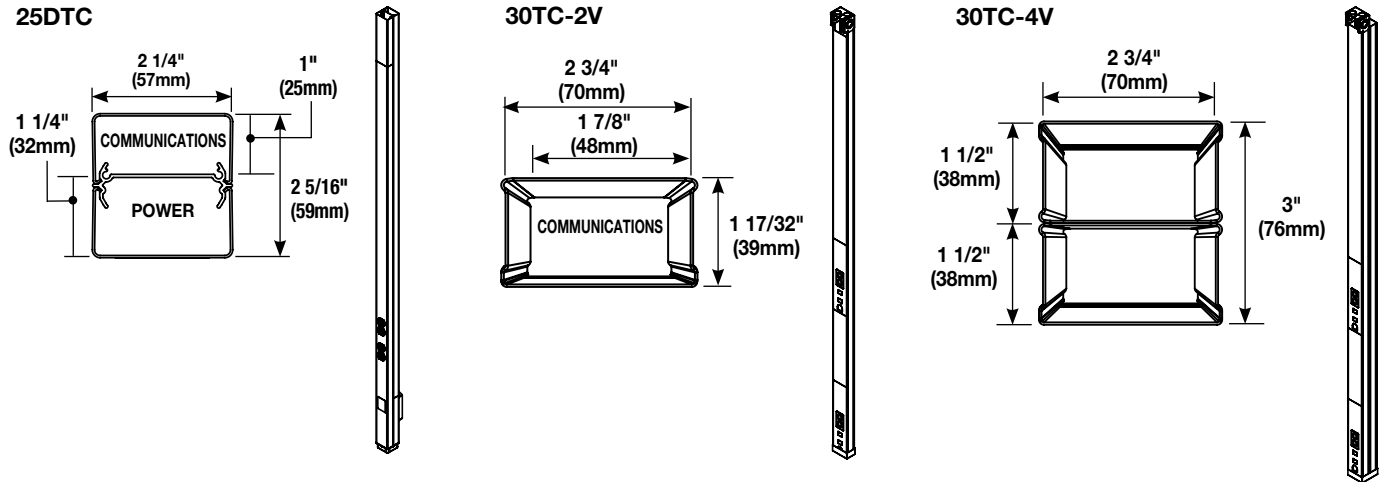





NOTE: For the 25DTC custom colors, other lengths (20' (6.1m) max.) or additional circuits are available on custom orders. Consult factory for more information. Can be factory or field wired with many commercially available devices.
For the 30TC-2V and 30TC-4V custom colors or additional circuits are available on custom orders. Consult factory for more information. Can be factory or field wired with many commercially available devices.

25DTC & 30TC Series Vertical Drop Poles Communications Fill Capacities													
CATALOG NUMBER	POLE HEIGHT		FINISH	Cat 5		Cat 6		RG58/U		RG62A/U		RG6/U	
	Inches	(mm)		0.22" (5.6mm)	0.25" (6.3mm)	0.195" (5.0mm)	0.242" (6.1mm)	0.270" (6.9mm)	Sm. Comp.	Lg. Comp.	Sm. Comp.	Lg. Comp.	Sm. Comp.
25DTC-4	10' 5"	(3.175m)	Ivory, Gray,	19	26	16	22	25	33	16	21	12	17
25DTC-412	12' 5"	(3.780m)	Black,	19	26	16	22	25	33	16	21	12	17
25DTC-415	15' 5"	(4.700m)	White	19	26	16	22	25	33	16	21	12	17
25DTC-E10	10' 5"	(3.175m)	Ivory, Gray	19	26	16	22	25	33	16	21	12	17
30TC-2V	10' 5"	(3.175m)	Ivory	n/a	33	n/a	30	n/a	47	n/a	30	n/a	24
30TC-212V	12' 5"	(3.780m)	Ivory	n/a	33	n/a	30	n/a	47	n/a	30	n/a	24
30TC-215V	15' 5"	(4.700m)	Ivory	n/a	33	n/a	30	n/a	47	n/a	30	n/a	24
30TC-4V	10' 5"	(3.175m)	Ivory	37	37	30	30	47	47	30	30	24	24
30TC-412V	12' 5"	(3.780m)	Ivory	37	37	30	30	47	47	30	30	24	24
30TC-415V	15' 5"	(4.700m)	Ivory	37	37	30	30	47	47	30	30	24	24
30TC-3S2	10' 5"	(3.175m)	Ivory	37	37	30	30	47	47	30	30	24	24
30TP-412V3S2	12' 5"	(3.780m)	Ivory	37	37	30	30	47	47	30	30	24	24

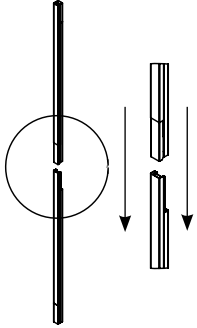
Raceway Wire & Cable Fill Capacities for Tele-Power Poles					
Cable Type	Cable Wire Size Description	AMTC & 25DTC SERIES		30TP-4V SERIES	30TC-4V SERIES
		Small Compt. 40% FILL	Large Compt. 40% FILL	40% FILL	40% FILL
THHN/THWN	10 AWG	34	44	30	66
	12 AWG	54	68	48	106

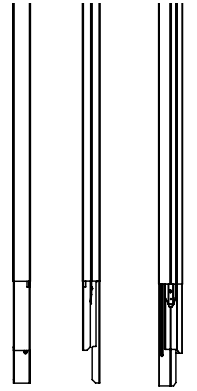
Steel Tele-Power Poles Ordering Information

Catalog No./Item	Description/Specifications	Catalog No./Item	Description/Specifications
<p>25DTC-4 25DTC-4WH 25DTC-4BK 25DTC-4DG 25DTC-412 25DTC-412WH 25DTC-412BK 25DTC-412DG 25DTC-415 25DTC-415WH 25DTC-415BK 25DTC-415DG</p> 	<p>Blank Steel Pole – Two-compartment pole. Nominal material thickness .040" (1.0mm). Ivory, white, black or gray boot base. Furnished unwired without outlets. Mounting hardware, entrance end plate and ceiling trim plates furnished. Available lengths: 10' 5" (3.2m) (25DTC-4), 12' 5" (3.8m) (25DTC-412) and 15' 5" (4.7m) (25DTC-415).</p> <p>Country of Origin: USA</p>	<p>25DTC-E10 25DTC-E10-DG</p> 	<p>Blank Steel Express Pole – Two sections of a two-compartment pole (5' 4" (1.626m) base and 5' (1.52m) extender) assembles to form a 10' 4" (3.148m) pole. Nominal material thickness .040" (1.0mm). Ivory or gray boot base. Furnished unwired without outlets. Mounting hardware, entrance end plate and ceiling trim plate furnished. An 8" (203mm) cover at top of pole is removable for making power wiring connections.</p> <p>Country of Origin: USA</p>
<p>30TC-2V 30TC-212V 30TC-215V</p> 	<p>Blank Steel Pole – Single-compartment pole. Furnished unwired without outlets. Nominal wall thickness .040" (1.0mm). Mounting hardware, entrance end fitting, and ceiling trim plate furnished. Available lengths: 10' 5" (3.2m) (30TC-2V), 12' 5" (3.8m) (30TC-212V) and 15' 5" (4.7m) (30TC-215V).</p> <p>Country of Origin: USA</p>	<p>25DTC-E5 25DTC-E5WH 25DTC-E5BK 25DTC-E5DG</p> 	<p>Steel Pole Extender – Two-compartment extender mounts onto existing 25DTP or 25DTC series pole. Nominal material thickness .040" (1.0mm). Furnished unwired without outlets. Uses existing pole mounting hardware, entrance end plate and ceiling trim plate. Available in 5' (1.524m) length. Can be cut to desired length.</p> <p>Country of Origin: USA</p>
<p>30TC-4V 30TC-412V 30TC-415V</p> 	<p>Blank Steel Pole – Two-compartment pole. Furnished unwired without outlets. Nominal wall thickness .040" (1.0mm). Mounting hardware, entrance end fitting, and ceiling trim plate furnished. Available lengths: 10' 5" (3.2m) (30TC-4V), 12' 5" (3.8m) (30TC-412V) and 15' 5" (4.7m) (30TC-415V).</p> <p>Country of Origin: USA</p>	<p>Front Side Back</p>	



New Tele-Power Pole Extenders make transporting and installing power poles a snap, literally.

NOTE: All poles have removable cover sections with KOs for modular jacks and openings to accept modular furniture adapters for communication devices.

Aluminum Tele-Power Poles

When looking to dress up a vertical solution, Tele-Power Poles with a satin anodized aluminum finish in either rectangular or round styles can provide the answer. Light weight aluminum construction makes these poles easy to install and maneuver on the job site. Available prewired with electrical devices or blank to drop services feeding another wire and cable management system, such as electrified modular furniture. A full range of accessories enables field configurability, or have them delivered to your specifications.

AMDTP-4

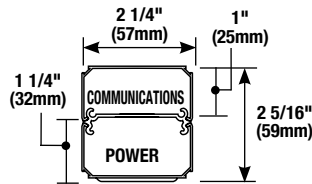

ALTP

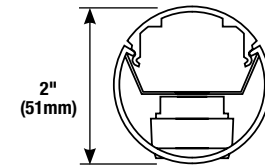

NOTE: There is no method provided for mounting data jacks in this pole.

NOTE: Custom colors, other lengths (20' (6.1m) max. – AMDTP-4 only) or additional circuits are available on custom order. Consult factory for more information. Can be factory or field wired with many commercially available devices.

Aluminum Tele-Power Poles Wire Fill Capacities

CATALOG NUMBER	NUMBER & TYPE OF POWER OUTLETS	POLE HEIGHT Inches (mm)	FINISH	Wire Size THHN/THWN		Cat 5		Cat 6		RG58/U		RG62A/U		RG6/U	
				#10	#12	0.22" (5.6mm) 20%* 40%**	0.25" (6.3mm) 20%* 40%**	0.195" (5.0mm) 20%* 40%**	0.242" (6.1mm) 20%* 40%**	0.270" (6.9mm) 20%* 40%**					
AMDTP-4 AMDTP-412 AMDTP-415	Two Duplex Receptacles (20A, 125V)	10' 5" (3.175m) 12' 5" (3.780m) 15' 5" (4.700m)	Satin Anodized Aluminum	10	15	10	19	8	16	13	25	8	16	7	13
AMDTP-4D	Two Duplex Receptacles (20A, 125V), One Dedicated/ Isolated & One Standard Branch Circuit	10' 5" (3.175m)	Satin Anodized Aluminum	10	15	10	19	8	16	13	25	8	16	7	13
ALTP-2S	Four Single Receptacles	10' 4" (3.150m)	Satin Anodized Aluminum	-	-	2	5	2	4	3	6	2	4	1	3

* 20% cable fill is calculated to approximate reduction in cable capacity due to connectors mounted within pole section that may restrict cross-sectional areas.

** 40% cable fill is the maximum designed cable fill based on a proposed revision to TIA/EIA 569-A.

Aluminum Vertical Drop Poles Communications Fill Capacities

CATALOG NUMBER	POLE HEIGHT Inches (mm)	FINISH	Cat 5		Cat 6		RG58/U		RG62A/U		RG6/U	
			0.22" (5.6mm) Sm. Comp. Lg. Comp.	0.25" (6.3mm) Sm. Comp. Lg. Comp.	0.195" (5.0mm) Sm. Comp. Lg. Comp.	0.242" (6.1mm) Sm. Comp. Lg. Comp.	0.270" (6.9mm) Sm. Comp. Lg. Comp.					
AMDTP-4 AMDTP-412 AMDTP-415	10' 5" (3.175m) 12' 5" (3.780m) 15' 5" (4.700m)	Satin Anodized Aluminum	10 19	8 16	13 25	8 16	7 13					
ALTP-2S	10' 4" (3.150m)	Aluminum	10	8	13	8	6					
NP800C-12-2B NP800C-12-8B NP800C-15-2B	10' 2" (3.098m) 12' 8" (3.860m) 15' 2" (4.620m)	Aluminum	Please see Chart on the next page for Wire & Cable Capacities of the various configurations of the NP800 Series Poles.									



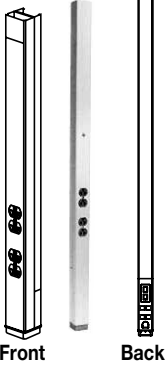
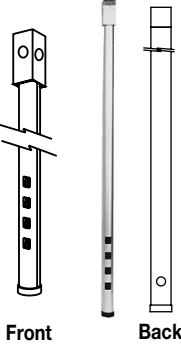
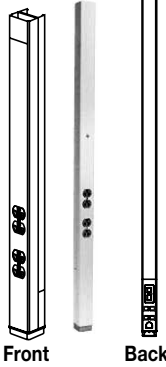

Wiremold Tele-Power Poles offer relocation flexibility to support open office designs. Quickly and easily reconfigure poles to meet changes in floor plans or capacity needs.

Aluminum Tele-Power Poles Ordering Information

Catalog No./Item	Description/Specifications	Catalog No./Item	Description/Specifications
AMDTP-4 AMDTP-412 AMDTP-415	<p>Tele-Power Pole – Two-compartment pole (power and communications). Nominal material thickness .050" (1.8mm). Factory wired with fed-spec general grade 20A, 125V duplex style receptacles. The 8" (203mm) cover at the top front of the pole is removable for making power wiring connections. Communication KOs provided for RJ11/RJ45 and modular furniture connectors. Mounting hardware, entrance end plate and two ceiling trim plates furnished. Available in standard lengths of: 10' 5" (3.2m) (25DTP-4), 12' 5" (3.8m) (25DTP-412) and 15' 5" (4.7m) (25DTP-415).</p> <p>Country of Origin: USA</p>	 <p>Front Back</p>	<p>ALTP-2S</p>  <p>Front Back</p> <p>Round Tele-Power Pole – Satin anodized extruded aluminum pole. Nominal wall thickness .060" (1.5mm). Length 10' 5" (3.2m). Two-compartment (power and communication channels). Factory wired with four 15A 125V NEMA 5-15R devices. Provided with one 1/2" trade size KO in cover at base for communications for cable pass through. T-Bar mounting hardware, ceiling trim kit, and feed box furnished.</p> <p>Country of Origin: USA</p>
AMDTP-4D	<p>Tele-Power Pole – Two-compartment pole (power and communications). Nominal material thickness .050" (1.8mm). Factory wired with one (1) dedicated/ isolated ground duplex receptacle and one (1) 20A, 125V standard duplex receptacle. The 8" (203mm) cover at the top front of the pole is removable for making power wiring connections. Communication KOs provided for RJ11/RJ45 and modular furniture connectors. Mounting hardware, entrance end plate and two ceiling trim plates furnished. Available in standard length of: 10' 5" (3.2m).</p> <p>Country of Origin: USA</p>	 <p>Front Back</p>	<p> AMDTP-4-C 🇨🇦 AMDTP-412-C 🇨🇦 AMDTP-415-C 🇨🇦 </p> <p>Tele-Power Pole – Available in Canada Only. Two-compartment pole (power and communications). Nominal material thickness .050" (1.8mm). AMDTP-4-C Length: 10'5" (3.2m), AMDTP-412-C Length: 12'5" (3.8m), AMDTP-415-C Length: 15'5" (4.7m). Factory wired with 15A, 125V fed-spec general grade duplex style receptacles. Communication KOs provided for RJ11/RJ45 and modular furniture connectors. Mounting hardware, entrance end fitting, and ceiling trim plates furnished. Anodized aluminum finish. Comes with a 10' (3.0m) cord.</p> <p>Country of Origin: USA</p>

NOTE: Custom colors, custom lengths (20' (6.1m) max. – AMDTP-4 only) or additional circuits are available on custom order. Consult factory for more information. Can be factory or field wired with many commercially available devices.

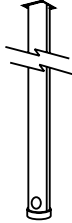
Aluminum Tele-Power Poles Ordering Information

Catalog No./Item	Description/Specifications	Catalog No./Item	Description/Specifications
<p>AMTC-4 AMTC-412 AMTC-415</p> 	<p>Blank Aluminum Pole – Two-compartment pole. Nominal material thickness .050" (1.8mm). Furnished unwired without outlets. Two 8" (203mm) removable covers with KOs for modular jacks and modular furniture communication outlets. Mounting hardware, entrance end plate, and ceiling trim plates furnished.</p> <p>Available lengths: AMTC-4 – 10' 5" (3.2m) , AMTC-412 – 12' 5" (3.8m) AMTC-415 – 15' 5" (4.7m)</p> <p>CUSTOM OPTIONS: Features such as colors or other lengths (20' (6.1m) maximum) available on custom orders.</p> <p>Country of Origin: USA</p>	<p>ALTC-2S</p> 	<p>Blank Round Aluminum Pole – Satin anodized extruded aluminum pole. Nominal wall thickness .060" (1.5mm), length 10'3" (3.1mm). Provided with one 1/2" (12.7mm) trade size KO at base. T-bar mounting hardware, ceiling trim kit, foot assembly, and grommet included. Feed box not furnished.</p> <p>Country of Origin: USA</p>
<p>NP800C-10-2B NP800C-12-B NP800C-15-B</p> 	<p>Blank Aluminum Pole – Two-compartment large capacity pole. Furnished unwired without outlets. Box ended with industry sized knockouts. Standard heights:</p> <p>NP800C-10-2B – 10'2" (3.1m) NP800C-12-8B – 12'8" (3.9m) NP800C-15-2B – 15'2" (4.6m)</p> <p>CUSTOM OPTIONS: Other heights (30' max. available – consult factory. 30" (762mm) communication cover with industry standard knockouts.</p> <p>Country of Origin: USA</p>		



Use Wiremold Tele-Power Poles to deliver multiple services to your desired point-of-use or simply as a feeder system for modular furniture.

Aluminum Tele-Power Poles Ordering Information

NP800

Jumbo Tele-Power Pole – Two separate compartments can accommodate up to 60A devices (#6 AWG maximum). Snap-in divider permits up to six channels of varying sizes.

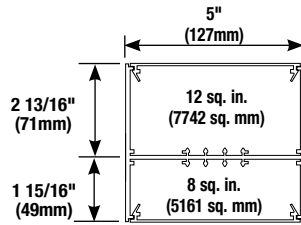

Country of Origin: USA

General Specifications:

Receptacles: Each pole compartment may be wired with up to 12 receptacles, with the number of circuits limited by the feed method.

Feed method: All poles are provided with a utility box (4" x 4" x 2 1/8" (102mm x 102mm x 54mm)) for all poles with a cord up to 10' (3m).

Accessories: Ceiling trim plates, pole clamp, and non-adjustable foot with carpet gripper/adhesive pad furnished.

NP800 SERIES WIRE FILL CAPACITIES FOR COMMUNICATIONS

CABLE TYPE Description Nom. O.D. Inches	UNSHIELDED TWISTED PAIR (24 AWG)					SHIELDED TWISTED PAIR				COAXIAL CABLE				TWINAX	FIBER*
	Cat 3 2 Pair 0.14	Cat 3 3 Pair 0.15	Cat 3 4 Pair 0.19	Cat 5 4 Pair 0.22	Cat 6 4 Pair 0.25	Cat 3 4 Pair 0.41	Type 1 22 AWG 0.39	Type 2 22 AWG 0.465	Type 3 22 AWG 0.245	RG58/U 20 AWG 0.195	RG58/U 22 AWG 0.242	RG6/U 22 AWG 0.242	RG6/U 18 AWG 0.27	100 OHM 0.33	0.19
Capacity of Cross-Section (IN ²)															
2.4	62	54	33	25	19	7	8	5	20	32	20	20	16	11	33
2.8	72	63	39	29	22	8	9	6	23	37	24	24	19	13	39
3.2	83	72	45	33	26	9	10	7	27	42	27	27	22	14	45
4.2	109	95	59	44	34	12	14	9	35	56	36	36	29	19	59
4.3	111	97	60	45	34	13	14	10	36	57	37	37	30	20	60
4.8	124	108	67	50	38	14	16	11	40	64	41	41	33	22	67
5.0	129	113	70	52	40	15	16	11	42	66	43	43	34	23	70
5.2	135	117	73	54	42	15	17	12	44	69	45	45	36	23	73
5.8	150	131	81	61	46	17	19	13	49	77	50	50	40	27	81
6.2	161	140	87	65	50	18	20	14	52	83	53	53	43	28	87
7.0	181	158	98	73	56	21	23	16	59	93	60	60	48	32	98
7.7	200	174	108	81	62	23	25	18	65	103	66	66	53	36	108
8.0	207	181	112	84	64	24	26	18	67	107	69	69	55	37	112
12.0	311	271	169	126	96	36	40	28	101	160	104	104	83	56	169

* Two Strand (Duplex) Multimode, 625/125µm. Capacity range is calculated at 40% of raceway areas as stated in the Commercial Buildings Standard for Telecommunication Pathways and Spaces, EIA/TIA 569-A.

NP800 SERIES WIRE FILL CAPACITIES FOR POWER

	WIRE SIZE THHN/THWN	40% FILL	CIRCUITS
POWER WIRING	10 AWG	12	4
	12 AWG	13	4
	14 AWG	15	5

NOTES: Wire fill capacities calculated for a pole with a 4" x 4" x 2 1/8" (102mm x 102mm x 54mm) box. Larger boxes can be used if higher capacity is needed.

All of the standard profiles can be easily modified. Contact the factory or the field sales representative for specifics.

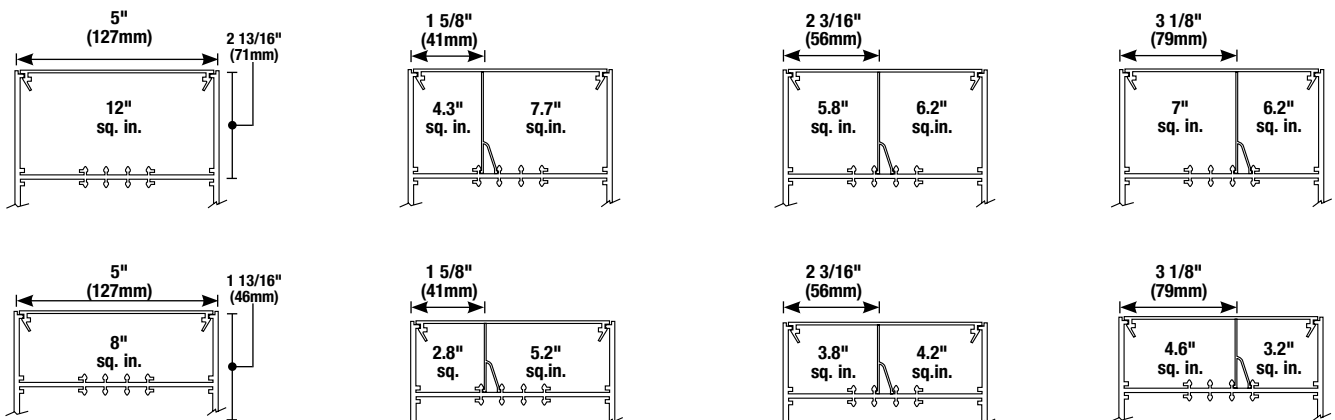

Accessories for Tele-Power Poles Ordering Information

Catalog No./Item

Description/Specifications

AMDTP-A
25DTP-A

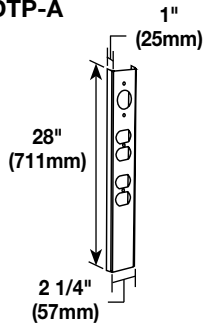

Add-On Power Cover – Add power receptacles or devices to existing modular Tele-Power Poles. Includes one receptacle mounting bracket. Face diameter of single receptacle: 1.38" - 1.40" (35mm - 36mm).

Country of Origin: USA

COLOR	
25DTP-A	Ivory Steel (25DTP-4)
AMDTP-A	Anodized Aluminum (AMDTP-4)

AMDTP-B
25DTP-B

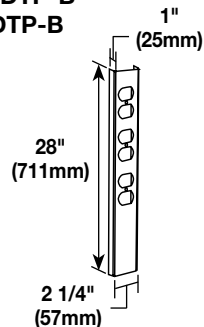

Add-On Power Cover – Add power receptacles or devices to existing modular Tele-Power Poles. Includes one receptacle mounting bracket.

Country of Origin: USA

COLOR	
25DTP-B	Ivory Steel (25DTP-4)
AMDTP-B	Anodized Aluminum (AMDTP-4)

AMDTP-L
25DTP-L

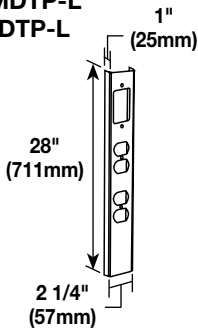

Add-On Power Cover – Add power receptacles or devices to existing modular Tele-Power Poles. Includes one receptacle mounting bracket.

Country of Origin: USA

COLOR	
25DTP-L	Ivory Steel (25DTP-4)
AMDTP-L	Anodized Aluminum (AMDTP-4)

30TP-A

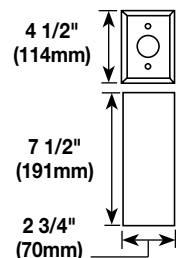

Single Receptacle Cover – Single receptacle cover for field installation of receptacles with face diameters of 1.38" - 1.40" (25mm - 36mm). G3007C Device Bracket included. Ivory finish.

Country of Origin: USA

Catalog No./Item

Description/Specifications

30TP-B

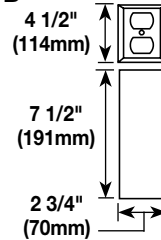

Duplex Receptacle Cover – For installations of 15A and 20A duplex receptacles. G3007C Device Bracket included. Ivory finish.

Country of Origin: USA

30TP-C

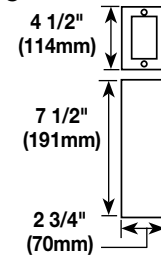

Single Gang Cover – Accepts up to 30A shallow-style device and flush plate. G3007C Device Bracket included. Ivory finish. Used to mount industry standard straight and angled communication faceplates.

Country of Origin: USA

30TP-J

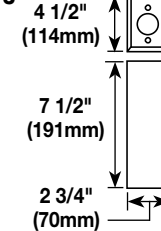

Single Receptacle Cover – For field installation of single receptacles with face diameters of 1.56" (40mm) diameter. G3007C Device Bracket included. Ivory finish.

Country of Origin: USA

30TP-L

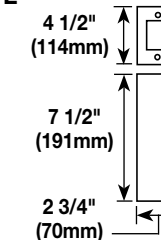

Rectangular Device Cover – Rectangular faceplate to accommodate Sentrex surge receptacles, GFCI and other decorator style devices. G3007C Device Bracket included. Ivory finish.

Country of Origin: USA

25DTC-3S2

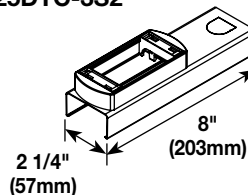

Data & A/V Add-On Cover for 25DTP Series Poles – Accepts three (3) Ortronics® Series II Modular Connectivity Solutions.

Country of Origin: USA

2507C

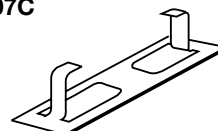

Receptacle Mounting Bracket – Enables mounting of a duplex receptacle to 25DTP and AMDTP Series Tele-Power Poles.

Country of Origin: USA

Accessories for Tele-Power Poles Ordering Information

Catalog No./Item	Description/Specifications	Catalog No./Item	Description/Specifications
25DTC-CVR 	Data & A/V Add-On Cover for 25DTP Series Poles – Accepts modular keystone and furniture jacks. Country of Origin: USA	CM-SFP 	Data & A/V Add-On Cover for 30TC Series Poles – Single-gang faceplate accepts three (3) CM Series Connectors. (Requires 30TP-C Mounting Plate.) Country of Origin: USA
30TC-CVR 	Data & A/V Add-On Cover for 30TC Series Poles – Accepts discrete jacks. Country of Origin: USA	CM-SAP 	Data & A/V Add-On Cover for 30TC Series Poles – Single-gang, angled faceplate accepts two (2) CM2 Series Connectors. (Requires 30TP-C Mounting Plate.) Country of Origin: USA
AMTC-CVR 	Data and A/V Add-On Cover for AMDTP-4 and AMTC-4 Series Poles – Accepts discrete jacks. Country of Origin: USA	25AM10FO 	Radius Controlled Entrance End Fitting – Ensure 2" (51mm) radius cradius at point of entry on 25DTP and AMDTP Series poles . Country of Origin: USA
30TP-AAP 	Add-On A/V Cover – Accepts three (3) Extron® Electronics AAP plates 12" L x 2.75" W (305mm x 70mm). Includes bezel to accommodate three (3) Wiremold CM2 modules or six (6) Ortronics® TracJack connectors. Country of Origin: USA	25AM-AP 	Replacement Accessory Pack – For 25DTP/25DTC and AMDTP/AMTC Series Poles. Includes: ceiling trim plate, end cap, bracket and grommet. Country of Origin: USA
30TP-MAAP 	Add-On A/V Cover – Accepts five (5) Extron® Electronics MAAP plates 12" L x 2.75" W (305mm x 70mm). Includes bezel to accommodate three (3) Wiremold CM2 modules or six (6) Ortronics® TracJack connectors. Country of Origin: USA	30TP-AP 	Replacement Accessory Pack – For 30TP-2/30TC-2 and 30TP-4/30TC-4 Series Poles. Includes: ceiling trim plate, bracket and grommet. Country of Origin: USA

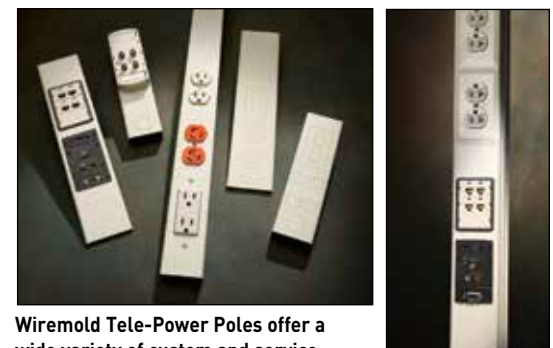

Wiremold Tele-Power Poles offer a wide variety of custom and service configuration options to accommodate most installation requirements.

NOTE: All brand and product names referenced in this document are registered trademarks or trademarks of their respective holders.

 **NOTE:** The paper used to print this document is an environmentally responsible paper with 10% post consumer waste, with FSC and SFI Chain of Custody certifications, Lacey Act compliant. 100% of the electricity used to manufacture Flo sheets is generated with Green-e certified renewable energy.



Legrand, North America
60 Woodlawn Street
West Hartford, CT 06110
1.877.BY.LEGRAND (295.3472)
www.legrand.us

Canada
905.738.9195
www.legrand.ca

FOLLOW US

