

Steel City

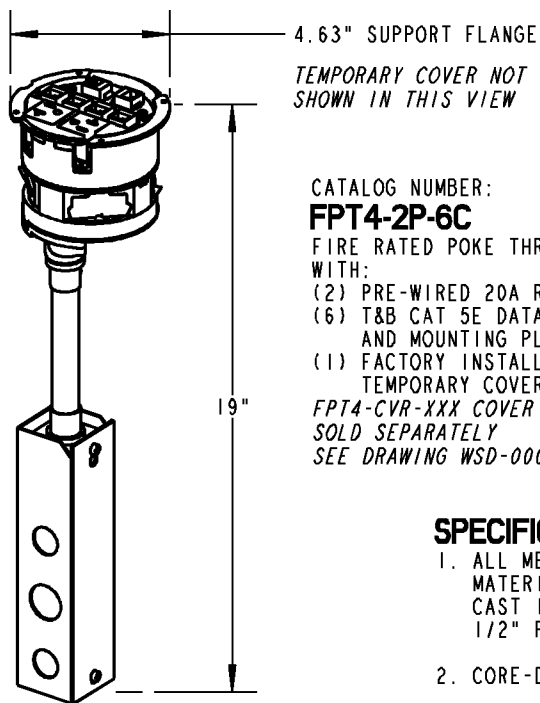

4.63" SUPPORT FLANGE
TEMPORARY COVER NOT SHOWN IN THIS VIEW

19"

CATALOG NUMBER:
FPT4-2P-6C
FIRE RATED POKE THROUGH BASE UNIT
WITH:
(2) PRE-WIRED 20A RECEPTACLES
(6) T&B CAT 5E DATA JACKS AND MOUNTING PLATES
(1) FACTORY INSTALLED 5" DIAMETER TEMPORARY COVER.
FPT4-CVR-XXX COVER SOLD SEPARATELY SEE DRAWING WSD-000261

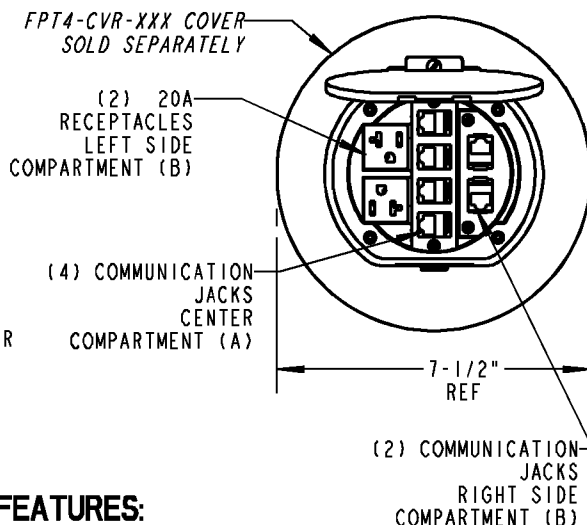

FPT4-CVR-XXX COVER SOLD SEPARATELY

(2) 20A RECEPTACLES LEFT SIDE COMPARTMENT (B)

(4) COMMUNICATION JACKS CENTER COMPARTMENT (A)

7-1/2" REF

(2) COMMUNICATION JACKS RIGHT SIDE COMPARTMENT (B)

SPECIFICATIONS / FEATURES:

- ALL METAL CONSTRUCTION WITH INTUMESCENT MATERIAL (FIRE RETARDANT). CAST IRON BOTTOM HUB WITH NPS THREADED HOLES FOR 1/2" POWER CONDUIT.
- CORE-DRILLED HOLE SIZE: 4 TO 4-1/16" DIAMETER
- UL LISTED AND CLASSIFIED. MEETS OR EXCEEDS UL AND CANADIAN SAFETY STANDARDS.
- FIRE RATING AND CONCRETE THICKNESS MIN/MAX:
FOR USE IN 1, 1-1/2 & 2-HOUR RATED FLOORS
1-HOUR RATED FLOOR
2-1/4" THICK MINIMUM CONCRETE OVER STEEL DECKING
3" MINIMUM CONCRETE FOR REINFORCED SLAB
7-1/2" MAXIMUM CONCRETE THICKNESS
2-HOUR RATED FLOOR - CONCRETE THICKNESS MIN/MAX:
3-1/4" THICK MINIMUM CONCRETE OVER STEEL DECKING
4" MINIMUM CONCRETE FOR REINFORCED SLAB
7-1/2" MAXIMUM CONCRETE THICKNESS
- FLOOR COVERINGS:
FOR USE ON CARPET AND WOOD COVERED CONCRETE FLOORS, TILE FLOOR COVERINGS UP TO 3/4" MAXIMUM THICKNESS, AND LINOLEUM FLOOR COVERINGS UP TO A MAXIMUM OF 1/8" THICKNESS.
- MAXIMUM ALLOWABLE COPPER CROSS-SECTIONAL AREA FOR COMMUNICATIONS:
LEFT SIDE THRU HOLE (B): POWER
CENTER THRU HOLE (A): .01630 SQ. INCHES
RIGHT SIDE THRU HOLE (B): .01536 SQ. INCHES
SEE SHEET 2 FOR COPPER CROSS SECTIONAL AREA TABLE
- COMMUNICATION CABLE AND JACKS CAN BE INSTALLED AFTER COVER IS INSTALLED TO FLOOR. SEE SHEET 2
- COMMUNICATION PLATES CAN BE ORDERED SEPARATELY FOR MOST DATA JACKS. SEE SHEET 2 AND 3

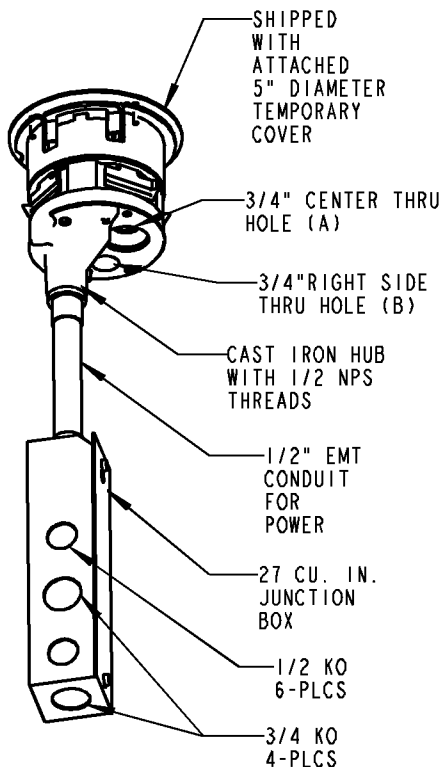

GENERAL NOTES

- ALL DIMENSIONS ARE FOR REFERENCE ONLY.
- DIMENSIONS IN BRACKETS [] ARE IN METRIC UNITS.

REVISIONS

*** SEE ERN (****) FOR APPROVAL SIGNATURES & RELEASE DATE. PROJECT NO: ****

DESCRIPTION:

FPT4-2P-6C POKE THROUGH BASE UNIT

Thomas & Betts
www.tnb.com

ORIGINAL PROJECT NO / (ERN NO)

UD55412 / (2006424)

SHEET NO:

1 OF 3

REV. NO:

-

DRAWING NO:

WSD-000236

COMMUNICATION INSTALLATION

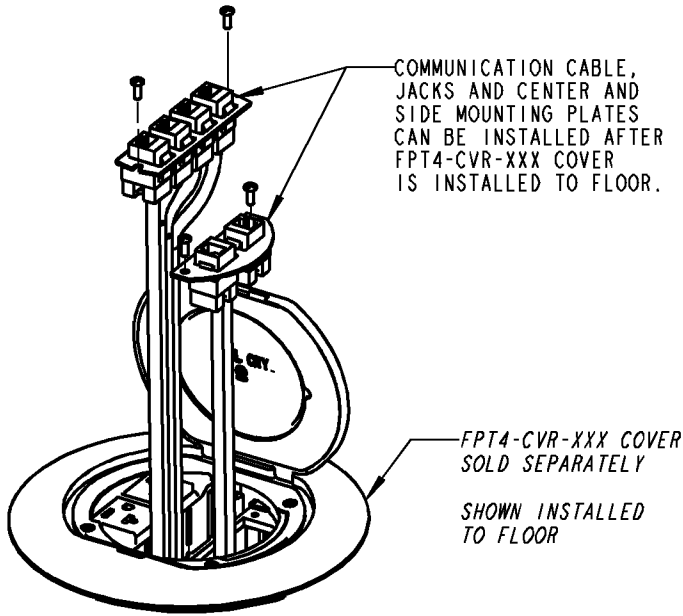

COPPER CROSS-SECTIONAL AREA OF COMMONLY USED CONDUCTORS

SIZE	SOLID
#24 AWG	.00032 SQUARE INCHES
#22 AWG	.00050 SQUARE INCHES
#14 AWG	.00323 SQUARE INCHES
#12 AWG	.00512 SQUARE INCHES
#10 AWG	.00815 SQUARE INCHES

NOTE: USE ABOVE VALUES FOR SOLID OR STRANDED CONDUCTORS.

FPT4-CPA CENTER COMMUNICATION PLATES SOLD SEPARATELY:

FOR SPECIAL JACK SIZES OR OPENINGS CONTACT T&B TECHNICAL SERVICES DEPARTMENT.

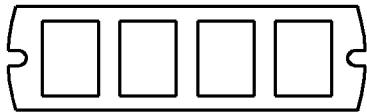

FPT4-CPA-4KEY
T&B KEYSTONE
HUBBLE
LEVITON-QUICKPORT
(1) SHIPPED WITH POKE
THROUGH BASE UNIT
CAT. NO. FPT4-2P-6C

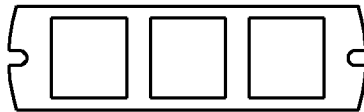

FPT4-CPA-3PAN
PANDUIT
REQUIRES #CMNZABL-X
ADAPTER FROM PANDUIT
TO MOUNT PANDUIT
MINI-CON JACKS.

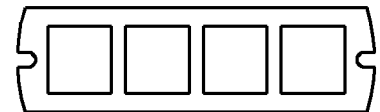

FPT4-CPA-4SYS
AVAYA MGS400
SYSTEMAX MGS500
AT&T

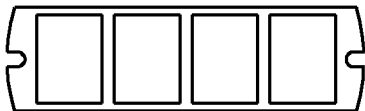

FPT4-CPA-4ORT
ORTRONICS
OR-TJ600

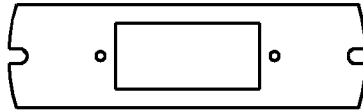

FPT4-CPA-1MAAP
ACCEPTS ONE
MAAP MINI ARCHITECTURAL
ADAPTER PLATE
EXTRON



FPT4-CPA-BLANK

Thomas & Betts
www.tnb.com

DESCRIPTION:

FPT4-2P-6C POKE THROUGH BASE UNIT

SHEET NO:

2 OF 3

REV. NO:

-

DRAWING NO:

WSD-000236

FPT4-CPB SIDE COMMUNICATION PLATES SOLD SEPARATELY:

FOR SPECIAL JACK SIZES OR OPENINGS CONTACT
T&B TECHNICAL SERVICES DEPARTMENT.

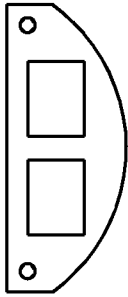

FPT4-CPB-2KEY

T&B KEYSTONE
HUBBLE
LEVITON-QUICKPORT
(1) SHIPPED WITH POKE
THROUGH BASE UNIT
CAT. NO. FPT4-2P-6C

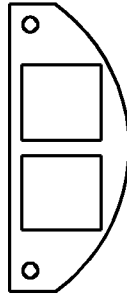

FPT4-CPB-2PAN

PANDUIT
REQUIRES #CMNZABL-X
ADAPTER FROM PANDUIT
TO MOUNT PANDUIT
MINI-CON JACKS.

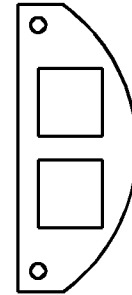

FPT4-CPB-2SYS

AVAYA
MGS400 SYSTIMAX
MGS500 AT &T

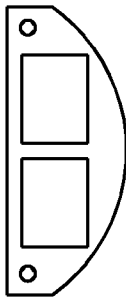

FPT4-CPB-2ORT

ORTRONICS
OR-TJ600

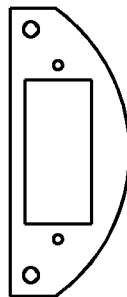

FPT4-CPB-1MAAP

ACCEPTS ONE
MAAP MINI ARCHITECTUAL
ADAPTER PLATE
EXTRON

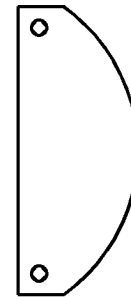

FPT4-CPB-BLANK

Thomas & Betts
www.tnb.com

DESCRIPTION: **FPT4-2P-6C POKE THROUGH BASE UNIT**

SHEET NO:

3 OF 3

REV. NO:

DRAWING NO:

WSD-000236