

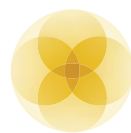

[Ambiance-Lighting.com](http://Ambiance-Lighting.com)



**AMBIANCE**  
Lighting Systems

2013 Full Line Catalog



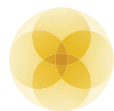

# AMBIANCE<sup>®</sup>

Lighting Systems

At Ambiance<sup>®</sup> Lighting Systems we have been engineering and producing high quality, customizable lighting solutions at affordable prices since being launched by Sea Gull Lighting 20 years ago. We were the first manufacturer to introduce a low-voltage under cabinet lighting system with the original Lx Cable System and have been innovating ever since. We now produce a variety of line and low-voltage systems — many of which can be connected together on one transformer using our proprietary fused plug connector — for use in architectural, commercial and residential applications. Whether you are a discerning lighting specifier or homeowner, Ambiance Lighting Systems are easy to configure and install for just the right lighting effect.



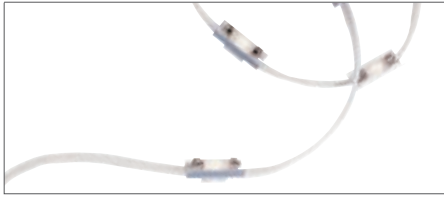

## Lx Cable System

LED, Xenon, Halogen, and Incandescent Light Sources

4



## Lx LED Tape Lighting

Flexible LED Light Source

24



## Disk Lighting

LED, Incandescent, and Xenon Light Sources

32

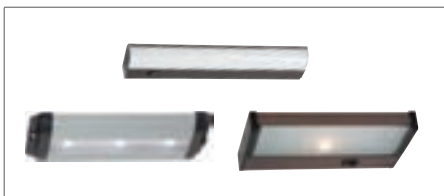

## Self-Contained Lighting

LED, Xenon, and Fluorescent Light Sources

48



## Transitions

LED, Halogen, Incandescent, and Fluorescent Light Sources

64



## Mini-Recessed Lighting

LED, Halogen, and Xenon Light Sources

84



## Technical Information

Powering Your System

90



# Lx Cable System

# Lx Cable System

The Ambiance® Lx Cable System has been about quality, flexible, lighting solutions and effects since it was launched in 1993. Today, we offer a full range of lamps, including LED options that use over 80% less energy than the standard 10 watt xenon festoons. One of the most highly regarded and specified lighting systems used in residential, commercial and retail environments, we are the premier under cabinet and cove lighting solution used by discerning specifiers, contractors and homeowners alike.



## Configure Your System



### STEP 1

**Choose Lamps & Lampholders**  
Select from a variety of low profile linear lamps and lamp holders that suit your application.

*page 8*

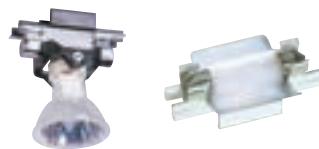

### STEP 2

**Select Cable**  
Specially designed 105°C easy piercing cable available in 25' to 1,000' spools. Indoor and outdoor rated available.

*page 18*





# Design Guidelines

The Ambiance® Lx Cable Lighting System is the versatile choice for linear lighting in a home or commercial setting. With our self-piercing lampholders and modules, you can easily position your luminaries where you need them along a run of Lx Cable to achieve the perfect lighting effect.

Cove



In Cabinet

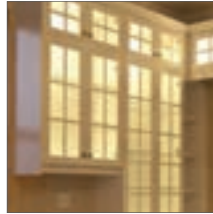

Toe Kick

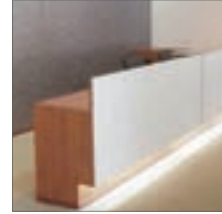

Task / Accent

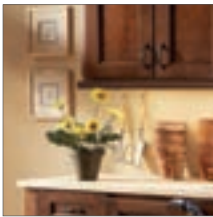

Under Cabinet

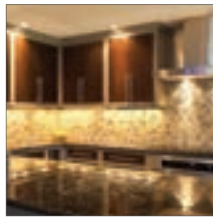

Under Counter

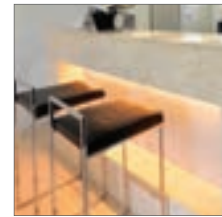

## STEP 3

Select Track  
4' Noryl® track  
section may be easily  
cut to desired length

*page 18*



## STEP 4

Select Components  
Additional components are  
available including screws,  
track clips, tape, track  
covers, connectors etc.

*page 19*



## STEP 5

Select Transformer  
Electronic and magnetic,  
12v or 24v, 60w up to  
1000w output

*page 21*

# STEP 1 Choose a Lamp

## High Output LED Module

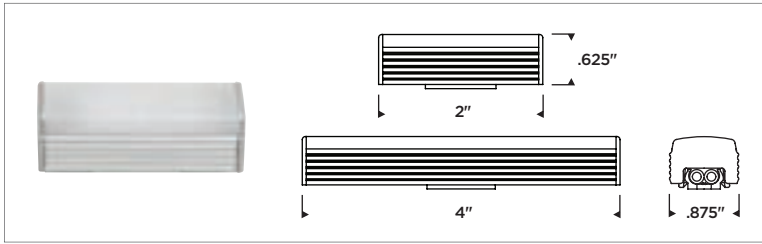

The miniature, high output LED modules can be used with 12 volt Ambiance Lx Cable Systems powered by magnetic low-voltage or electronic low-voltage transformers. Simply snap the high output LED modules onto Lx track and cable to provide a generous amount of illumination, no lamp holder necessary. These high intensity LED modules utilize wider minimum spacing than our festoons while still providing even surface illumination.

**NOTE:** Lamps in chart below do not require lampholders. See page 18 to select cable.

Item Number	98700S-986	98701S-986	98702S-986	98703S-986
Size	2" Length	2" Length	4" Length	4" Length
Color Temperature	2700°K	3000°K	2700°K	3000°K
Power Consumption	1.5 watts		3 watts	
Lumens	60	70	160	170
Efficacy	40 lm/w	47 lm/w	53 lm/w	57 lm/w
Min. Spacing	3" on center		5" on center	
Voltage	12V AC			
Color Rendering Index	>85 CRI			
Rated Average Life	50,000 hours to 70%			
Certification	cETL, damp rated			
Dimmable <sup>(1)</sup>	Yes to 10%			
Material / Finish	Low profile tinted aluminum housing with matching acrylic end caps			

<sup>(1)</sup> Ambiance High Output LED Modules are dimmable on magnetic and electronic low voltage systems. For magnetic systems, a magnetic low voltage (MLV) dimmer should be used. For electronic, an electronic low voltage (ELV) dimmer is recommended. See page 90 for more on dimming.

## Photometrics<sup>(2)</sup>

Zone (Degrees)	Lumens	% of Lamp
0° – 30°	41	25.43%
0° – 40°	66	41.30%
0° – 60°	116	72.47%
0° – 90°	152	95.10%
90° – 180°	8	4.90%
0° – 180°	160	100%

		Horizontal Angle (Degrees)		
		0°	45°	90°
Vertical Angle (Degrees)	0°	28473	28473	28473
	45°	24582	22068	21703
	55°	22950	20047	19941
	65°	20723	17710	17962
	75°	17125	14543	15514
	85°	9191	10347	12734

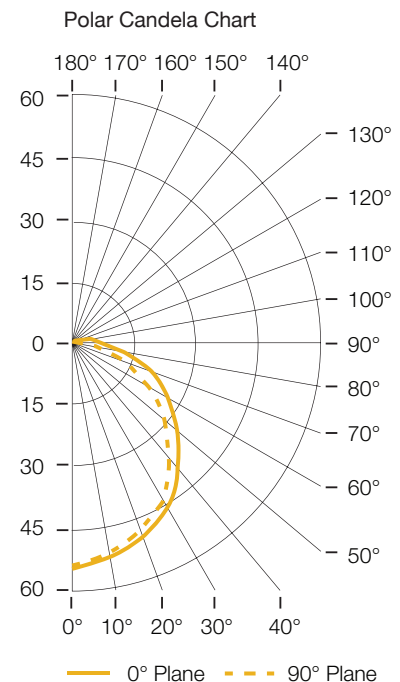

<sup>(2)</sup> Photometry based on (1) 98702S-986 4" LED Module in 2700°K CCT



Lx Cable System

# STEP 1 Choose a Lamp & Lampholder

## LED Festoon

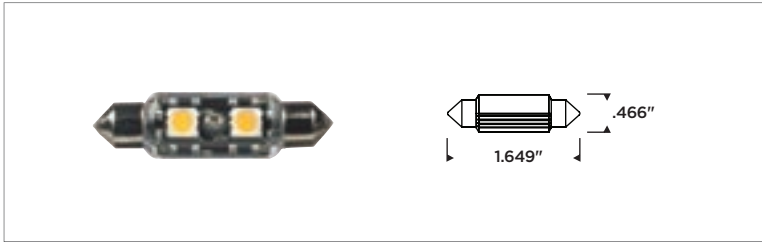

Upgrade to our Ambiance Lx LED Festoons from our 5w Xenon Festoons and realize an energy savings of over 80% without compromising light output. Lx LED Festoons snap into Lx Festoon Lampholders (sold separately), making retrofitting of existing systems easy. For new systems, pick a matching Lx Festoon Lampholder and clip them onto your Lx Cable and Track. Lx LED Festoons are available in 2700, 3000, and 4000°K, in both 12 and 24V.

**NOTE:** Lamps in chart below only compatible with Festoon Lampholder 9830 and Festoon Adjustable Lampholder 94323 (page 11).

Item Number	96116S(-xx)	96117S(-xx)	96118S(-xx)	96120S(-xx)	96119S(-xx)	96121S(-xx)
Color Temperature	2700°K	2700°K	3000°K	3000°K	4000°K	4000°K
Voltage	12V AC	24V AC	12V AC	24V AC	12V AC	24V AC
Power Consumption	.708 watts		.633 watts		.661 watts	
Lumens	29		25		26	
Efficacy	41 lm/w		39.5 lm/w		39.3 lm/w	
Color Rendering Index	>90 CRI		>90 CRI		>85 CRI	
Lamp Base	Festoon					
Rated Average Life	35,000 hours to 70%					
Min. Spacing	2" on center					
Dimmable <sup>(1)</sup>	Yes to 10%					
Material / Finish	(-32) Clear and (-33) Frosted					

<sup>(1)</sup> Ambiance Lx LED Festoons are dimmable on magnetic and electronic low voltage systems. For magnetic systems, a standard incandescent or magnetic low voltage (MLV) dimmer can be used. For electronic, an electronic low voltage (ELV) dimmer is recommended. See page 90 for more on dimming.

## Photometrics<sup>(2)</sup>

Zone (Degrees)	Lumens	% of Lamp
0° – 30°	7.189	28.1%
0° – 40°	11.88	46.4%
0° – 60°	21.18	82.7%
0° – 90°	25.58	99.9%
90° – 180°	0.03983	0.2%
0° – 180°	25.61	100%

Vertical Angle (Degrees)	Horizontal Angle (Degrees)		
	0°	45°	90°
0°	42990	42990	42990
45°	23130	24700	37790
55°	18270	20170	22700
65°	12450	13830	20140
75°	6089	5125	7166
85°	795	0	0

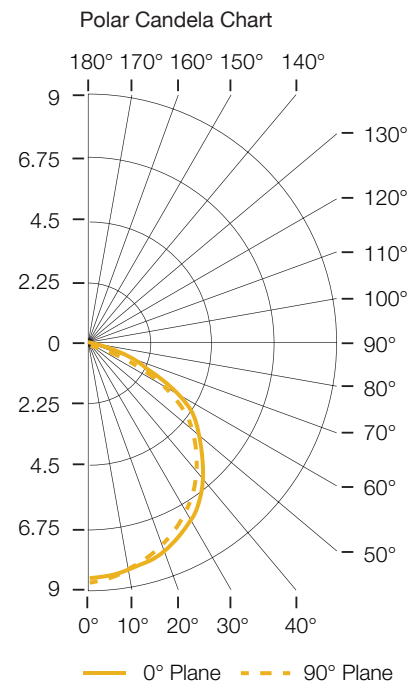

<sup>(2)</sup> Photometry based on (1) 96118S-32 Clear LED Lamp in 3000°K CCT

# STEP 1 Choose a Lamp & Lampholder

## Festoon Lampholders

For use with our highly specified LED and xenon festoons, Ambiance Lx Festoon Lampholders feature a high quality reflector and base for directing light where you need it. Choose from our Accent Task Socket for general applications that require crisp linear lighting or our Adjustable Lampholder for a wider diffused beam of light. Each lampholder snaps onto Lx Track and Cable with ease and can be spaced based on your criteria.

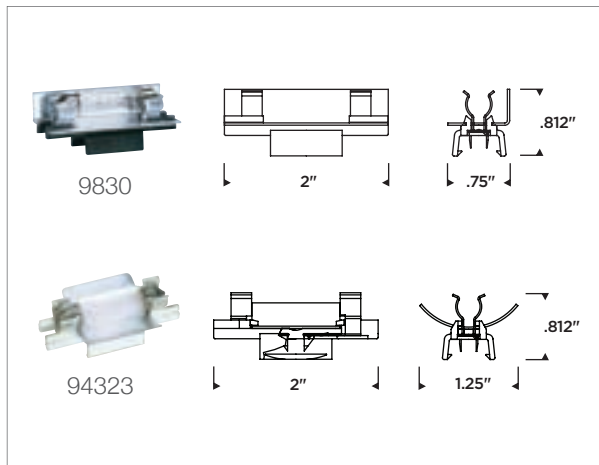

Item Number	9830(-xx)	94323(-xx)
Reflector	"L" Accent Task Socket	Adjustable Wide Beam
Voltage	12V and 24V AC	
Lamp Base	Festoon	
Certification	cETL, damp rated	
Max. Wattage	(1) 10w Xenon Festoon (1) LED Festoon	
Recommended Min. Spacing <sup>(1)</sup>	2" on center (5w Xenon) 4" on center (LED Festoon)	
Material / Finish	(-12) Black and (-15) White Heat resistant polycarbonate base and anodized aluminum reflector	

**NOTE:** After selecting lamp source and lampholder, proceed to page 18 to select cable.

<sup>(1)</sup>See application guide and lamp source page for more spacing guidelines.

## Application Guide

Application	Recommended Spacing on Center	Suggested Lamp Source(s)
Above Cabinet	6" - 12"	LED Festoon
Under Cabinet	2" - 6"	LED Festoon
Inside Cabinet	1 - 2 per shelf	LED Festoon
Toe Space	4"	LED Festoon
Showcase	4" - 6"	LED Festoon
Cove	2" - 6"	LED Festoon

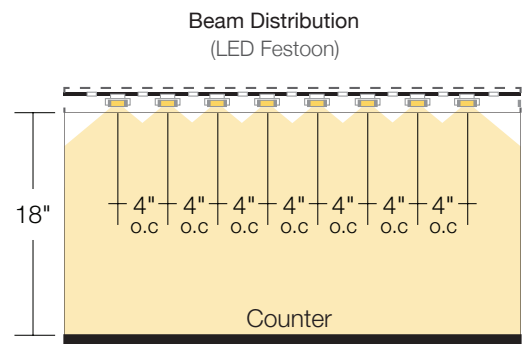

### Cove Lighting

Choose either Method "A" or "B" for even illumination on a vertical surface where cove lighting is desired. These easy to use spacing guidelines assure even vertical illumination when the suggested spacing and distances are followed.

**Method A:** Lighting system installed on angled surfaces.

**Method B:** Lighting system installed on horizontal (flat) surfaces.

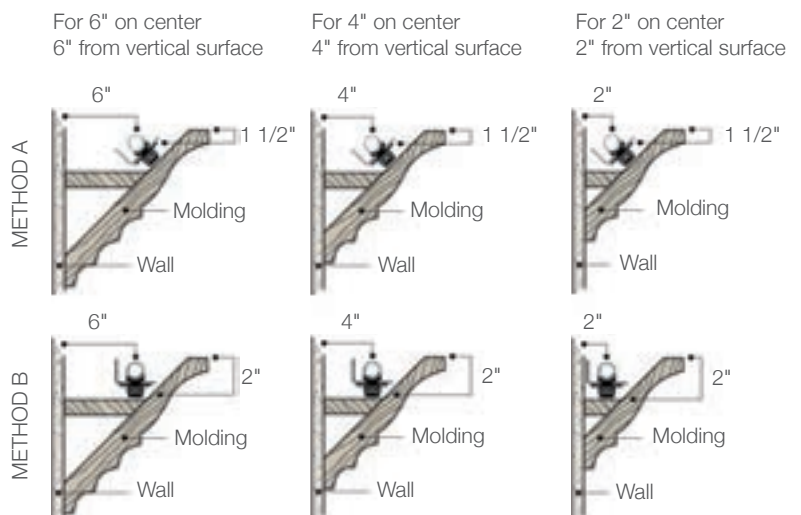

# STEP 1 Choose a Lamp & Lampholder

## Xenon Festoon

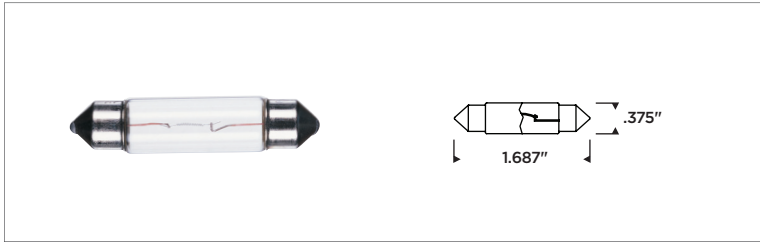

Ambiance Lx Xenon Festoons revolutionized the under cabinet lighting industry and continue to be an industry standard. They are available in 5, 7 and 10 watts and 12 or 24V. Choose from a wide beam or directional lampholder to easily position light where you need it (lampholder sold separately).

**NOTE:** Lamps in chart below only compatible with Festoon Lampholder 9830 and Festoon Adjustable Lampholder 94323 (page 13).

Item Number	97118(-xx)	97119(-xx)	97120(-xx)	97121(-xx)	97122(-xx)
Color Temperature	2550°K	2650°K	2550°K	2650°K	2420°K
Voltage	12V AC	12V AC	24V AC	24V AC	24V AC
Rated Watts	5 watts	10 watts	5 watts	10 watts	7 watts
Power Consumption	4.2 watts	8.4 watts	4.2 watts	8.4 watts	6.7 watts
Lumens	33	83	33	83	46
Efficacy	8 lm/w	10 lm/w	8 lm/w	10 lm/w	7 lm/w
Rated Average Life	16,000 hours	12,000 hours	16,000 hours	12,000 hours	95,000 hours
Lamp Base	Festoon				
Color Rendering Index	>90 CRI				
Min. Spacing	2" on center				
Dimmable	Yes				
Material / Finish	(-32) Clear and (-33) Frosted				(-33) Frosted

## Footcandle & Spacing Chart

Lamp Item #	Lampholder Spacing	Distance to Illuminated Surface				
		6"	12"	18"	24"	30"
97118(-xx) (5w, 12V)	2"	114	52	24	14	10
	4"	71	32	15	8.9	6.4
	6"	64	29	13	8	5.7
97120(-xx) (5w, 24V)	8"	57	26	12	7.1	5.1
	10"	51	23	11	6.3	4.5
	12"	45	20	9.5	5.6	4.0
97119(-xx) (10w, 12V)	4"	179	81	38	22	16
	6"	160	72	34	20	14
	8"	142	64	30	18	13
97121(-xx) (10w, 24V)	10"	128	58	27	16	11
	12"	114	52	24	14	10

# STEP 1 Choose a Lamp & Lampholder

## Festoon Lampholders

For use with our highly specified LED and xenon festoons, Ambiance Lx Festoon Lampholders feature a high quality reflector and base for directing light where you need it. Choose from our Accent Task Socket for general applications that require crisp linear lighting or our Adjustable Lampholder for a wider diffused beam of light. Each lampholder snaps onto Lx Track and Cable with ease and can be spaced based on your criteria.

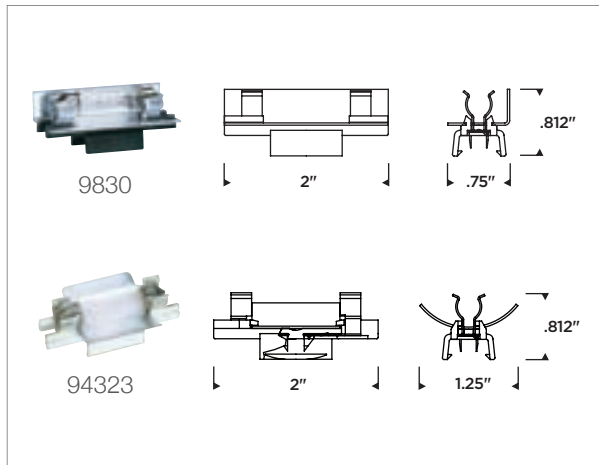

Item Number	9830(-xx)	94323(-xx)
Reflector	"L" Accent Task Socket	Adjustable Wide Beam
Voltage	12V and 24V AC	
Lamp Base	Festoon	
Certification	cETL, damp rated	
Max. Wattage	(1) 10w Xenon Festoon (1) LED Festoon	
Recommended Min. Spacing <sup>(1)</sup>	2" on center (5w Xenon) 4" on center (LED Festoon)	
Material / Finish	(-12) Black and (-15) White Heat resistant polycarbonate base and anodized aluminum reflector	

**NOTE:** After selecting lamp source and lampholder, proceed to page 18 to select cable.

<sup>(1)</sup>See application guide and lamp source page for more spacing guidelines.

## Application Guide

Application	Recommended Spacing on Center	Suggested Lamp Source(s)
Above Cabinet	6" - 12"	Xenon Festoon
Under Cabinet	2" - 6"	Xenon Festoon
Inside Cabinet	1 - 2 per shelf	Xenon Festoon
Toe Space	4"	5w Xenon
Showcase	4" - 6"	Xenon Festoon
Cove	2" - 6"	Xenon Festoon

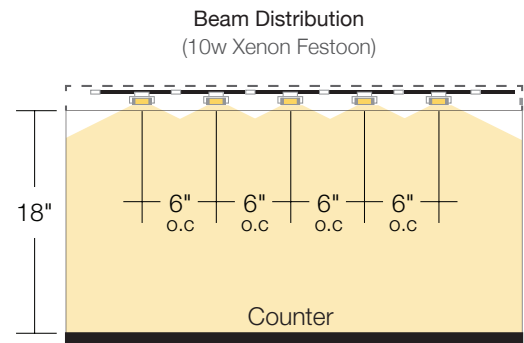

### Cove Lighting

Choose either Method "A" or "B" for even illumination on a vertical surface where cove lighting is desired. These easy to use spacing guidelines assure even vertical illumination when the suggested spacing and distances are followed.

**Method A:** Lighting system installed on angled surfaces.

**Method B:** Lighting system installed on horizontal (flat) surfaces.

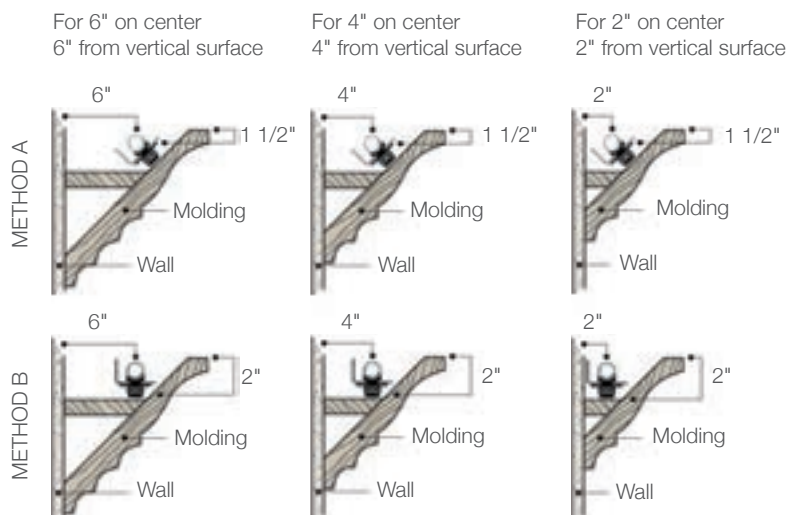

# STEP 1 Choose a Lamp & Lampholder

## Wedge Base

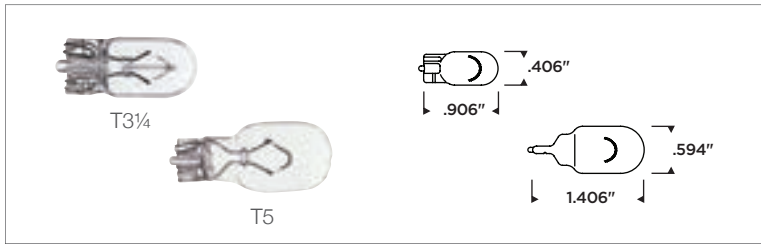

Ambiance Lx Wedge Base Lamps provide illumination for a varied list of applications. Where maximum illumination is required, couple high wattage incandescent or xenon wedge base lamps with the Lx Lampholder (9433). Lx Wedge Base Lamps add another level of versatility to Ambiance Lighting Systems.

**NOTE:** Lamps in first chart below only compatible with Wedge Base Lampholder 9433 (page 15).  
Lamps in second chart below only compatible with Two Light Wedge Base Lampholder 9428 (page 15).

Item Number	9774	9775	9776	9777	9778
Lamp Type	T5 Xenon		T5 Incandescent		
Color Temperature	2800°K	2800°K	2650°K	2750°K	2800°K
Voltage	12V AC	24V AC	12V AC	12V AC	12V AC
Rated Watts	18 watts	18 watts	8 watts	12 watts	18 watts
Power Consumption	16.2 watts	16.2 watts	8 watts	11.6 watts	16.2 watts
Lumens	210	210	57	120	210
Efficacy	13 lm/w	13 lm/w	7 lm/w	10 lm/w	13 lm/w
Rated Average Life	10,000 hours	2,000 hours	2,500 hours	2,000 hours	2,000 hours
Lamp Base	Wedge				
Min. Spacing	6" on center				
Color Rendering Index	>90 CRI				
Dimmable	Yes				

Item Number	9727	9728	9729	9731	9732
Lamp Type	T3 1/4 Incandescent			T3 1/4 Xenon	
Color Temperature	2200°K	2300°K	2450°K	2400°K	2550°K
Voltage	12V AC	12V AC	12V AC	12V AC	12V AC
Rated Watts	3 watts	5 watts	5 watts	3 watts	5 watts
Power Consumption	2.1 watts	4 watts	3.9 watts	2.7 watts	4.2 watts
Lumens	8	23	26	15	33
Efficacy	4 lm/w	6 lm/w	7 lm/w	6 lm/w	8 lm/w
Rated Average Life	20,000 hours	9,000 hours	2,000 hours	19,000 hours	8,000 hours
Lamp Base	Wedge				
Min. Spacing	2" on center				
Color Rendering Index	>90 CRI				
Dimmable	Yes				



# STEP 1 Choose a Lamp & Lampholder

## Wedge Base Lampholders

For use with our xenon and incandescent wedge base lamps, Ambiance Lx Wedge Base Lampholders feature a high quality reflector for minimizing light loss from your selected lamps. Choose from either our two lamp socket or our high illumination, single socket lampholders based on the needs of your application. Each lampholder snaps onto Lx Track and Cable with ease and can be spaced based on your criteria and lamp source (sold separately).

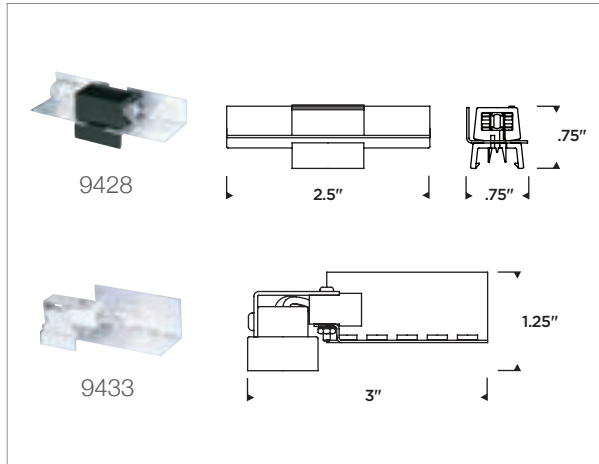

**NOTE:** After selecting lamp source and lampholder, proceed to page 18 to select cable.

Item Number	9433(-xx)	9428(-xx)
Reflector	High illumination breakaway for 90° or 180° beam	Two lamp socket, ideal for cove lighting
Voltage	12V and 24V AC	12V and 24V AC
Certification	cETL, damp rated	cETL, damp rated
Lamp Type	T5 Wedge	T3¼ Wedge
Max. Wattage	(1) 18w incandescent or xenon	(2) 5w incandescent or xenon
Min. Spacing	6" on center	4" on center
Material / Finish	(-15) White breakaway anodized aluminum reflector and heat resistant polycarbonate.	(-12) Black and (-15) White anodized aluminum reflector and heat resistant polycarbonate.

## Application Guide

Application	Recommended Spacing on Center	Suggested Lamp Source(s)
Above Cabinet	2" - 4"	3w-5w Incandescent or Xenon
Under Cabinet	6"	8w-18w Incandescent or Xenon
Inside Cabinet	1 - 2 per shelf	3w-5w Incandescent or Xenon
Toe Space	2" - 4"	3w-5w Incandescent or Xenon
Showcase	6"	8w-18w Incandescent or Xenon
Cove	4"	3w-5w Incandescent or Xenon

## Reflector Options

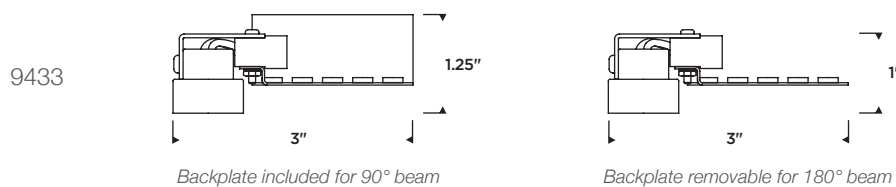

# STEP 1 Choose a Lamp & Lampholder

## MRC11 / MR16



Our selection of MRC11/MR16 GU4 base lamps add directional accent lighting to the list of options for your Ambiance Lx Cable System. Highlight areas of interest along your linear run with adjustable lampholders for added precision (lampholders sold separately).

**NOTE:** Lamps in chart below only compatible with MRC11/MR16 Adjustable Lampholder 9417 and MRC11/MR16 Spot Lampholder 9835 (page 17).

Item Number	9787	9789	97004	97405S	97305S	97505S
Lamp Type	MRC11 Halogen			MR16 LED		
Color Temperature	3000°K			2700°K	3000°K	4000°K
Voltage	12V AC	12V AC	24V AC	12V		
Watts Consumed	20 watts			6 watts		
Lumens	10	30	30	246	258	282
Efficacy	0.5 lm/w	1.5 lm/w	1.5 lm/w	41 lm/w	43 lm/w	47 lm/w
Beam Spread	NSP 10°	NFL 30°	NFL 30°	FL 40°		
Lamp Base	GU4 Bi-Pin			GU5.3 Bi-Pin		
Rated Average Life	2,000 hours			35,000 hours to 70%		
Color Rendering Index	>90 CRI			>85 CRI		
Min. Spacing	6" on center					
Dimmable	Yes					

## Photometrics<sup>(2)</sup>

### Zonal Lumen Summary

Zone (Degrees)	Lumens	% of Lamp
0° – 60°	247.2	96.3%
60° – 90°	9.5	3.7%
0° – 90°	256.7	100%
90° – 180°	0.0	0.0%
0° – 180°	256.7	100%

### Footcandle Summary

Distance to Floor	Diameter in Feet	Footcandles
1.7'	1.1	200
3.3'	2.2	50
5.0'	3.3	22
6.7'	4.4	13
8.3'	5.5	8
10.0'	6.6	6

### Polar Candela Chart

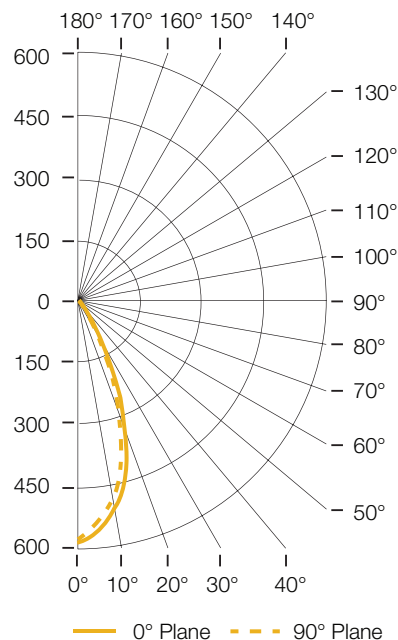

<sup>(2)</sup> Photometry based on (1) 97305S MR16 LED Lamp in 3000°K CCT

# STEP 1 Choose a Lamp & Lampholder

## MRC11 / MR16 Lampholders

Ambiance Lx MRC11/MR16 Lampholders are the perfect solution for providing accent, spot or task lighting from your Lx Cable System. Adjustable swivel sockets offer complete control of your chosen lamps. You can add Lx MRC11/MR16 Lampholders to any Ambiance Lx System with ease by snapping them onto your track and cable.

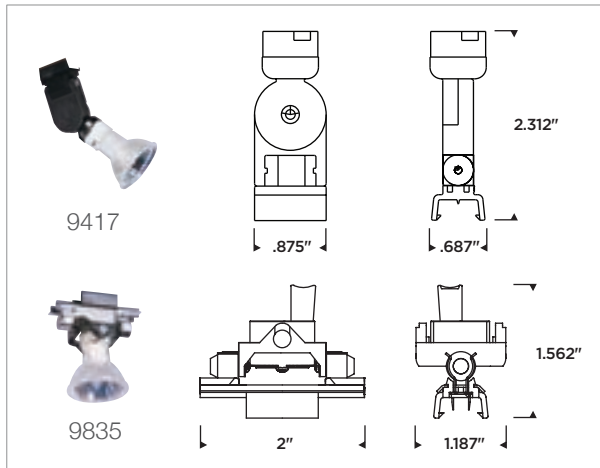

Item Number	9417(-xx)	9835(-xx)
Voltage	12V and 24V AC	12V and 24V AC
Max. Adjustable Rotation	90° front/back 180° left/right	45° front/back 45° left/right
Certification	cETL, damp rated	cETL, damp rated
Lamp Base	GU4 Bi-Pin	
Max. Wattage	(1) 20w MRC11 Halogen (1) 6w MR16 LED	
Min. Spacing	6" on center	
Material / Finish	(-12) Black and (-15) White Heat resistant polycarbonate base and ceramic socket	

**NOTE:** After selecting lamp source and lampholder, proceed to page 18 to select cable.

## Application Guide

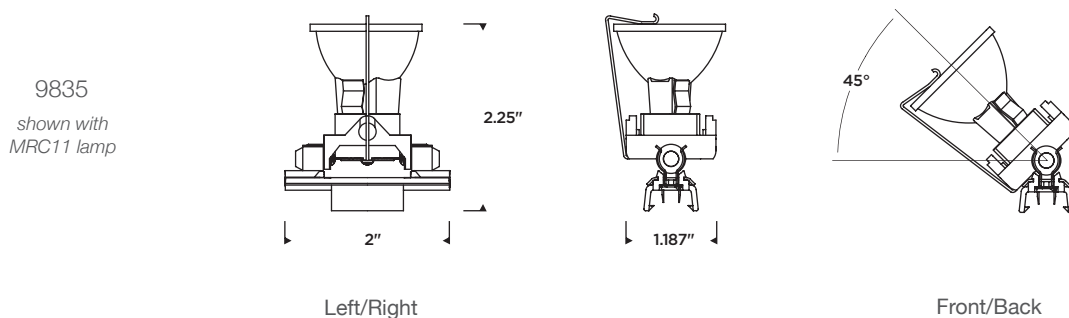
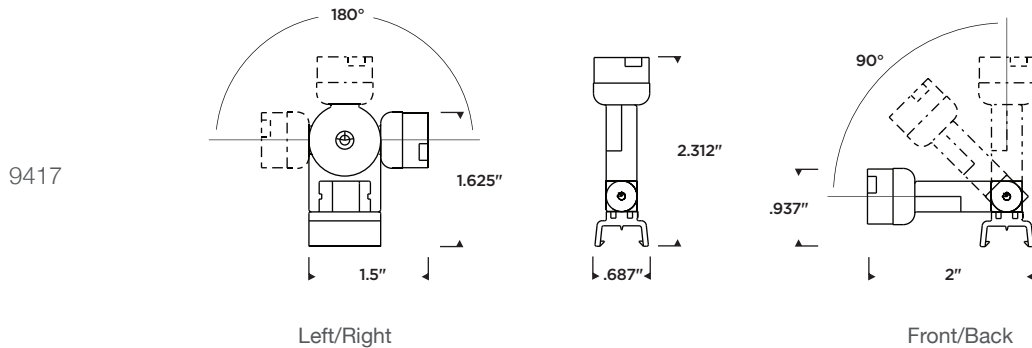

## STEP 2 Select Cable

Spools of cable specially designed with easy piercing, self-sealing insulation over stranded copper wire for use with Ambiance Lx Cable Lighting System. Markings for lampholder placement every 2". Designed to be mounted in Ambiance Lx Track.

### Indoor 25' Spool <sup>(1)</sup>

Part Number	Finish	Dimensions
9469-12	Black	L: 25' W: .375" H: .187"
9469-15	White	L: 25' W: .375" H: .187"

### Indoor 50' Spool <sup>(1)</sup>

Part Number	Finish	Dimensions
9470-12	Black	L: 50' W: .375" H: .187"
9470-15	White	L: 50' W: .375" H: .187"

### Indoor 100' Spool <sup>(1)</sup>

Part Number	Finish	Dimensions
9471-12	Black	L: 100' W: .375" H: .187"
9471-15	White	L: 100' W: .375" H: .187"

### Outdoor 100' Spool <sup>(2)</sup>

Part Number	Finish	Dimensions
9373-12	Black	L: 100' W: .375" H: .187"
9373-15	White	L: 100' W: .375" H: .187"

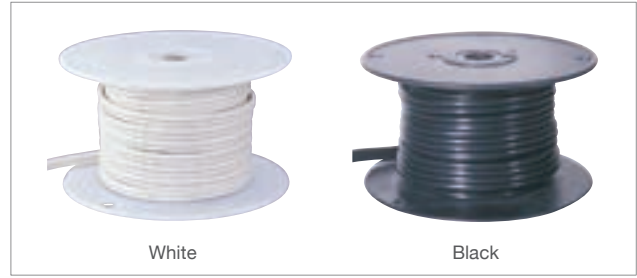

White

Black

### Indoor 500' Spool <sup>(1)</sup>

Part Number	Finish	Dimensions
9472-12	Black	L: 500' W: .375" H: .187"
9472-15	White	L: 500' W: .375" H: .187"

### Indoor 1000' Spool <sup>(1)</sup>

Part Number	Finish	Dimensions
9473-12	Black	L: 1000' W: .375" H: .187"
9473-15	White	L: 1000' W: .375" H: .187"

<sup>(1)</sup> Lx 10/2 AWG 105° C cable is rated for indoor use only. Maximum wattage per length 300w at 12V; 600w at 24V. Cable is not rated to run behind walls. Check with local codes.

<sup>(2)</sup> 9373-12 and 9373-15 AWG 105° C cable is rated for outdoor use only. Maximum wattage is 250w at 12V; 500w at 24V.

## STEP 3 Select Track

### Track

Noryl® track to support cable and lampholders. Use double faced tape (9450), track clip (9438) or screws (9862) through pre-drilled holes to attach track to surface. Track may be flexed, notched, curved and easily cut for various applications.



Part Number	Finish	Dimensions
9435-12	Black	L: 48" W: .5" H: .25"
9435-15	White	L: 48" W: .5" H: .25"

### Track with Fascia Panel

One piece Noryl® fascia panel with integral track to support cable and lampholders. Use under shelves or where system cannot be hidden behind a lip on cabinets. Track/fascia may be easily cut to various lengths. Use double faced tape (9450) track clip (9438) or screws (9862) through pre-drilled holes to attach track/fascia to surface. Use double-faced tape on glass and other smooth surfaces.



Part Number	Finish	Dimensions
9443-12	Black	L: 48" W: .875" H: 1.125"
9443-15	White	L: 48" W: .875" H: 1.125"

### Quick-n-Easy Track

Track complete with pre-installed mounting screws and spacers every 6" for fast installation. Track may be flexed, notched, curved and easily cut for various applications.

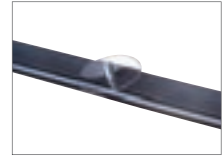

Part Number	Finish	Dimensions
94035-12	Black	L: 48" W: .875" H: .5"
94035-15	White	L: 48" W: .875" H: .5"

### Track with Lens

Noryl® track with clear plastic diffuser to support cable and lampholders. Use 9862 screws through pre-drilled retractor holes to attach track to surface. Clear polycarbonate lens snaps onto specially designed track. Track and lens may be cut to any length. Use with, 9428 and 9830 lampholders only, 10w maximum each. Minimum spacing 6".



Part Number	Finish	Dimensions
9874-15	White	L: 48" W: 1.875" H: 1.25"

## STEP 4 Select Components

### Track Clip

Polycarbonate track mounting clip. Easily snaps on at any point along 9435 track or 9443 track/fascia panel to secure to surface. Space clips according to weight of fixtures, to prevent track from sagging. Includes .375" long #4 screw.



Part Number	Finish	Dimensions
9438-12	Black	L: 1" W: .75" H: .343"
9438-15	White	L: 1" W: .75" H: .343"

### Double Faced Tape

Specially designed "High Adhesion" 3M™ double-faced tape for use with 9435 track, 9443 track/fascia panel and 9874 track with lens. Allow minimum 24 hours curing of adhesive prior to applying power to the circuit.

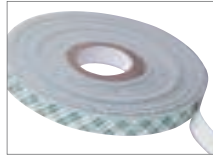

Part Number	Finish	Dimensions
9450	3M™	L: 25' W: .375" H: .031"

### Screws

3/8" long #4 Phillips flat head screws for attaching 9874 or 9435 track or 9443 track/fascia panel to surface. Each box contains 50 screws.

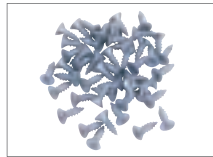

Part Number	Finish	Dimensions
9862	Zinc	#4 L: .375"

### Tap off Connector

Polycarbonate tap off connector. Use to tap off of low voltage Ambiance® Cable and create a parallel run for shelving, etc. Corrosion resistant contacts pierce the specially designed Ambiance® cable for electrical connection. Listed 12v and 24v. Wet location 12v only. Maximum wattage after connection on 105°C Ambiance® tap cable: 200w at 12v; 375w at 24v.



Part Number	Finish	Dimensions
9380-12	Black	L: 1.5" W: 1.5" H: .437"
9380-15	White	L: 1.5" W: 1.5" H: .437"

### Cable Sleeve

High temperature, flame retardant, flexible sleeving to cover cable when running through holes in cabinets, walls, etc. Cut to desired length and/or slit for easy installation. May also be used as a T3 1/4 lamp extractor.



Part Number	Finish	Dimensions
9431-94	Clear	D: .625" L: 36"

### Track Cover

Noryl® track cover to form a concealed raceway or conduit when used with 9435 track. Cover may be cut to fit between lampholders on track to hide cable. Cover snaps onto 9435 track and/or 9443 track/fascia panel.



Part Number	Finish	Dimensions
9439-12	Black	L: 48" W: .625" H: .312"
9439-15	White	L: 48" W: .625" H: .312"

### Left or Right Corner Cover

Polycarbonate 90° right or left cover snaps onto 9435 track and 9439 cover to create finished look and a concealed raceway.

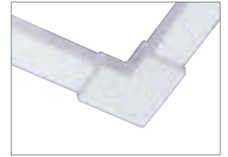

Part Number	Finish	Dimensions
9447-12	Black	L: 1.25" W: .812" H: .375"
9447-15	White	L: 1.25" W: .812" H: .375"

### Wall to Ceiling Cover

Polycarbonate 90° wall to ceiling cover snaps onto 9435 track and 9439 cover to create a finished look and a concealed raceway.



Part Number	Finish	Dimensions
9446-12	Black	L: .875" W: .812" H: .375"
9446-15	White	L: .875" W: .812" H: .375"

### Track End Cap

Polycarbonate end cover snaps onto 9435 track and 9439 cover to create a finished look and a concealed raceway.



Part Number	Finish	Dimensions
9445-12	Black	L: .812" W: .312" H: .375"
9445-15	White	L: .812" W: .312" H: .375"

### Fascia End Cap

Polycarbonate fascia end cover snaps onto either end of 9443 track/fascia panel to create a finished look and to hide the lighting system when viewed from either end.



Part Number	Finish	Dimensions
9448-12	Black	L: 1.25" W: .312" H: 1.187"
9448-15	White	L: 1.25" W: .312" H: 1.187"

## STEP 4 Select Components

### Wiring Compartment

Steel wiring compartment with hole for .5" conduit connector, snap on cover and opening for track and cable. Includes terminal block for connection between transformer extension wire (i.e. Romex type) and low voltage cable. Maximum 25 amps.



Part Number	Finish	Dimensions
9481-12	Black	L: 2" W: 1.312" H: 1.25"
9481-15	White	L: 2" W: 1.312" H: 1.25"

### Miniature Wiring Compartment / Splicer

Polycarbonate splicer with cover for connection between transformer extension wire (i.e. Romex) and low voltage cable, or LED Tape Connector. Maximum 25 amps.



Part Number	Finish	Dimensions
9459-12	Black	L: 2" W: .968" H: .625"
9459-15	White	L: 2" W: .968" H: .625"

### Fused Plug

For powering multiple Ambiance low voltage luminaires from an Lx Cable System. See page 92 for detailed wiring information.



Part Number	Finish	Dimensions
9488-12	Black	L: .875" W: .75" H: .812"
9488-15	White	L: .875" W: .75" H: .812"

## Magnetic Transformers

Magnetic transformers are encased in a powder coated metal enclosure that is potted to minimize noise and vibration. All are UL/cUL Listed, NEC 411 Approved, thermally protected, dimmable and have resettable magnetic circuit breakers for short circuit protection. Housings feature easy-hang bracket, wiring access door and knockouts for line voltage entry.

### Hardwire 12V Magnetic Transformer

Include boost tap for use when transformer is located 20' or more from first light.



#### 150w 12V Single Output

Part Number	Finish	Dimensions
94460-12	Black	L: 10.5" W: 4.312" H: 4.312"

#### 300w 12V Single Output

Part Number	Finish	Dimensions
94462-12	Black	L: 10.5" W: 4.375" H: 3.875"

#### 600w 12V (2 x 300w) Dual Output

One switch operates both 300 watt outputs encased in housing. Balance load on each transformer output.

Part Number	Finish	Dimensions
94464-12	Black	L: 10.562" W: 5" H: 5"

### Hardwire 24V Magnetic Transformer

24V 1000w model has a high ambient rating for use in areas up to 55°C (132°F). Include boost tap for use when transformer is located 20' or more from first light.



#### 250w 24V Single Output

Part Number	Finish	Dimensions
94461-12	Black	L: 10.75" W: 4.5" H: 4.25"

#### 500w 24V Single Output

Part Number	Finish	Dimensions
94463-12	Black	L: 11.5" W: 4.5" H: 4.25"

#### 1000w 24V (2 x 500w) Dual Output

One switch operates both 500 watt outputs encased in housing. Balance load on each transformer output.

Part Number	Finish	Dimensions
94465-12	Black	L: 12.5" W: 6.25" H: 6"

### Multi-Tap

Multi-tap transformers compensate for voltage drop on long secondary runs.

#### 12V (12, 13, 14, 15V)

#### 300w 12V Single Output

Part Number	Finish	Dimensions
94062-12	Black	L: 8.75" W: 4.375" H: 3.875"

#### 600w 12V Single Output

Part Number	Finish	Dimensions
94064-12	Black	L: 9.5" W: 5.375" H: 4.75"

#### 24V (24, 26, 28, 30V)

#### 500w 24V Single Output

Part Number	Finish	Dimensions
94063-12	Black	L: 9.5" W: 5.375" H: 4.75"

#### 1000w 24V Single Output

Part Number	Finish	Dimensions
94065-12	Black	L: 10.5" W: 6" H: 5.5"

# STEP 5 Select Transformer

## Electronic Transformers

Our electronic transformers have soft-start circuitry that increases lamp life. They emit no audible noise, employ automatically resetting short circuit protection, are UL and cUL Listed, moisture and shock resistant and are dimmable.

### Hardwire 12V Electronic Transformers

#### 60w AC Class II *Zero Load*

No minimum load required for operation. Ideal for 12V AC LED systems. UL 2108 flame resistant plastic enclosure. Includes wiring compartment with terminal block for 12/2 AWG max Romex type input and terminal block on opposite end for 10/2 AWG Ambiance® Lx Cable output. Designed for in-line wiring, ideal for under cabinet mounting.

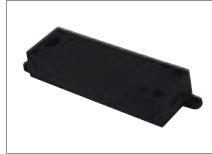

Part Number	Finish	Dimensions
96223S-12	Black	L: 5" W: 1.6" H: 1"
96223S-15	White	L: 5" W: 1.6" H: 1"

Wattage: 0w – 60w Class II Input: 120V AC | Output: 12V AC

#### 60w AC Class II

UL 2108, flame resistant plastic enclosure. Includes terminal block for 12/2 AWG max Romex type input and 10/2 AWG Ambiance® Lx Cable output. Designed to be mounted vertically at the bottom of the unit. 6" input and output leads for easy installation.



Part Number	Finish	Dimensions
9454-12	Black	L: 2.75" W: 1.5" H: 1.125"

Wattage: 15w – 60w Class II Input: 120V AC | Output: 12V AC

#### 60w AC Class II

UL 2108, flame resistant plastic enclosure. Includes terminal block for 12/2 AWG max Romex type input and 10/2 AWG Ambiance® Lx Cable output. Designed to be mounted vertically at the bottom of the unit. 6" input and output leads for easy installation.



Part Number	Finish	Dimensions
98054-12	Black	L: 2.75" W: 1.5" H: 1.125"

Wattage: 15w – 60w Class II Input: 120V AC | Output: 12V AC

#### 150w AC Class I

UL 2108, flame resistant plastic enclosure. Includes terminal block for 12/2 AWG max Romex type input and 10/2 AWG Ambiance® Lx Cable output. Designed to be mounted vertically at the bottom of the unit.



Part Number	Finish	Dimensions
9456-12	Black	L: 6.25" W: 2.25" H: 1.67"

Wattage: 60w – 150w Class I Input: 120V AC | Output: 12V AC

#### 150w AC Class I

UL 2108, flame resistant plastic enclosure. Includes a terminal block on one end for 12/2 AWG max. Romex input and a terminal block on the opposite end for 10/2 AWG Ambiance® Cable providing an in-line connection. Ideal for mounting under cabinet.



Part Number	Finish	Dimensions
98159-12	Black	L: 7.125" W: 2" H: 1"
98159-15	White	L: 7.125" W: 2" H: 1"

Wattage: 60w – 150w Class II Input: 120V AC | Output: 12V AC

#### 120w (2 x 60w) AC Dual Class II

UL 2108, flame resistant plastic enclosure. Includes terminal block for one 10/2 AWG max. Romex input and two Class II 60w outputs up to 10 AWG wire.



Part Number	Finish	Dimensions
98176-12	Black	L: 5" W: 3.25" H: 1"
98176-15	White	L: 5" W: 3.25" H: 1"

Wattage: 2 x (15w - 60w) Class II Input: 120V AC | Output: 12V AC



# STEP 5 Select Transformer

## Plug-in 12V Electronic Transformers

### 60w AC Class II *Zero Load*

No minimum load required for operation. Ideal for 12V AC LED systems. UL 2108 flame resistant plastic enclosure. Complete with pre-installed 8 foot 18/2 cord with quick connect plug on input side. Includes optional quick connect on/off switch for easy attachment to input cord. Includes pre-installed 36" output cable with Lx Fused Plug to energize 12V Lx Cable/Track.



Part Number	Finish	Dimensions
96224S-12	Black	L: 5" W: 1.6" H: 1"
96224S-15	White	L: 5" W: 1.6" H: 1"

Wattage: 0w – 60w Class II Input: 120V AC | Output: 12V AC

### 60w AC Class II

UL 2108, flame resistant plastic enclosure complete with pre-installed 8 foot 18/2 cord with quick connect plug on input side. Includes optional quick connect on/off switch for easy attachment to input cord. Includes pre-installed 36" output cable with Lx Fused Plug to energize 12V Lx Cable/Track.



Part Number	Finish	Dimensions
98055-12	Black	L: 5" W: 1.6" H: 1"
98055-15	White	L: 5" W: 1.6" H: 1"

Wattage: 15w – 60w Class II Input: 120V AC | Output: 12V AC

### 150w AC Class I

UL 2108, flame resistant plastic enclosure. Includes terminal block for easy connection to Ambiance® Lx cable output. Complete with pre-installed 8 foot, 18/2 cord with quick connect plug input side. Includes optional quick connect on/off switch for easy attachment to input cable. Designed to be mounted vertically. Input and output are located at bottom of the unit.



Part Number	Finish	Dimensions
9458-12	Black	L: 6.25" W: 2.25" H: 1.67"

Wattage: 60w – 150w Class I Input: 120V AC | Output: 12V AC



# Lx LED Tape Lighting

# Lx LED Tape Lighting

Ambiance® Lx LED Tape provides versatile, energy efficient, long lasting LED linear lighting for a wide variety of applications. With its ultra low-profile and optically clear coating, Lx LED Tape can be easily installed in a variety of settings to provide discrete, high quality illumination. Available in a variety of lengths and color temperatures with either a black or white face, Lx LED Tape Lighting by Ambiance® is a great addition to any space.



## Configure Your System



### STEP 1

**Choose LED Tape Strips**  
Select tape length, voltage, color temperature and face color based on your desired specifications.

*page 28*



### STEP 2

**Select Connectors & Cables**  
Determine required connectors and cuts to achieve your system configuration.

*page 30*



### STEP 3

**Select Transformers**  
Multiply the number of feet in your run by 3 watts to determine transformer size. Match voltage of the transformer to your LED tape's voltage.

*page 31*



**Optional Components**  
Mount tape with included 3M™ industrial adhesive backing or mounting clips.

*page 31*



**Fused Plug**  
For connecting to Lx Cable System  
*page 31*

# Design Guidelines

Ambiance® Lx LED Tape Lighting is the easy-to-install, long lasting solution for hidden linear illumination. With its ultra-low profile, our LED tape can be hidden in virtually any space. With our protective silicone coating, you can be confident that your tape will be maintenance free and perform the way you expect.

Cove



In Cabinet

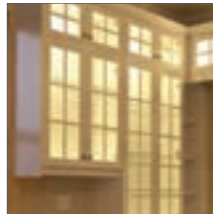

Toe Kick



Task / Accent

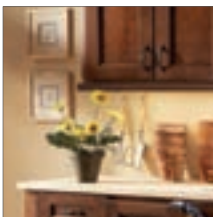

Under Cabinet

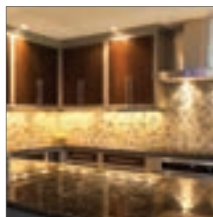

Under Counter

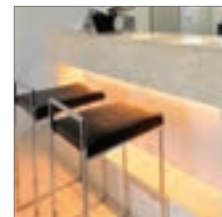

Under Cabinet  
Segmented Runs

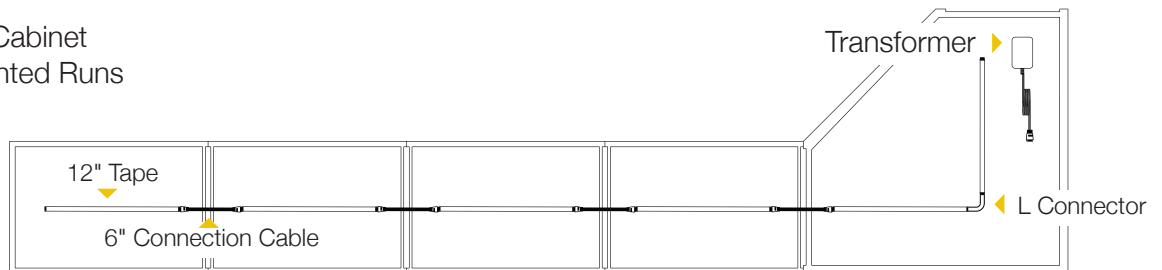

Continuous Runs  
Up to 40' with 24V

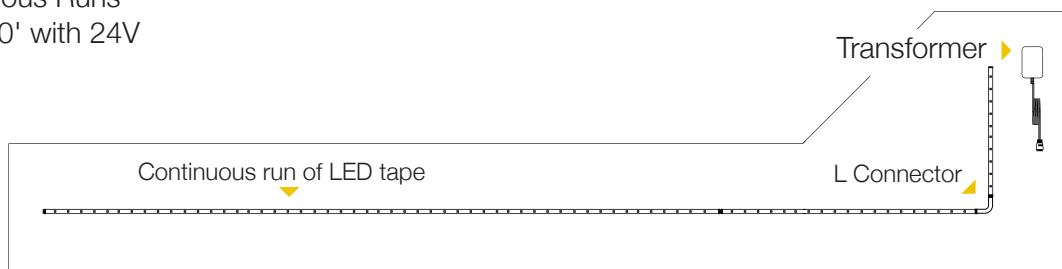

# STEP 1 Choose Lx LED Tape

## 12V AC LED Tape Lighting



(shown in black)

Item Number	98605SW(-xx)	98606SW(-xx)	98607SW(-xx)	98608SW(-xx)	98675SW(-xx)	98676SW(-xx)	98677SW(-xx)	98678SW(-xx)
Size	2" Length	1' Length	5' Length	16' Length (16 x 1' strips)	2" Length	1' Length	5' Length	16' Length (16 x 1' strips)
Color Temperature	3000°K	3000°K	3000°K	3000°K	2700°K	2700°K	2700°K	2700°K
Power Consumption	3 watts per foot							
Lumens	150 per foot				120 per foot			
Efficacy	50 lm/w				40 lm/w			
Color Rendering Index	>85 CRI							
Rated Average Life	50,000 hours to 70%							
Dimmable <sup>(1)</sup>	Yes to 10%							
Included Accessories	1 endcap, 2 mounting clips and screws (per foot)							
Max. Run Length	20 feet							
Material / Finish	(-12) Black and (-15) White Flexible copper PC board concealed in optically clear silicone protective coating, with high-endurance 3M™ adhesive backing							

## 24V AC LED Tape Lighting



(shown in white)

Item Number	98611SW(-xx)	98612SW(-xx)	98613SW(-xx)	98614SW(-xx)	98681SW(-xx)	98682SW(-xx)	98683SW(-xx)	98684SW(-xx)
Size	2" Length	1' Length	5' Length	16' Length (16 x 1' strips)	2" Length	1' Length	5' Length	16' Length (16 x 1' strips)
Color Temperature	3000°K	3000°K	3000°K	3000°K	2700°K	2700°K	2700°K	2700°K
Power Consumption	3 watts per foot							
Lumens	150 per foot				120 per foot			
Efficacy	50 lm/w				40 lm/w			
Color Rendering Index	>85 CRI							
Rated Average Life	50,000 hours to 70%							
Dimmable <sup>(1)</sup>	Yes to 10%							
Included Accessories	1 endcap, 2 mounting clips and screws (per foot)							
Max. Run Length	40 feet							
Material / Finish	(-12) Black and (-15) White Flexible copper PC board concealed in optically clear silicone protective coating, with high-endurance 3M™ adhesive backing							

<sup>(1)</sup> Ambiance LED Tape is dimmable on magnetic and electronic low voltage systems. For magnetic systems, a standard incandescent or magnetic low voltage (MLV) dimmer can be used. For electronic, an electronic low voltage (ELV) dimmer is recommended. See page 90 for more on dimming.

# STEP 1 Choose Lx LED Tape

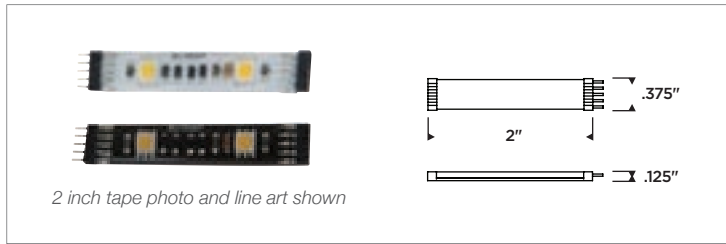

Ambiance Lx LED Tape provides ultra-low profile LED linear lighting that can be mounted securely with its 3M™ adhesive backing, and/or the included mounting clips. Ambiance Lx LED Tape is available in a variety of lengths, with black or white facing and in two color temperatures. Pair with some of our optional connector cords, molded connectors and mounting clips to make corners and curves easy to achieve.



## Photometrics<sup>(2)</sup>

Zonal Lumen Summary

Zone (Degrees)	Lumens	% of Lamp
0° – 30°	40.8	26.0%
0° – 40°	67.1	42.8%
0° – 60°	119.8	76.5%
0° – 90°	155.8	99.5%
90° – 180°	0.8	0.5%
0° – 180°	156.6	100%

Average Luminance Table (cd/m<sup>2</sup>)

		Horizontal Angle (Degrees)		
		0°	45°	90°
Vertical Angle (Degrees)	0°	18280	18280	18280
	45°	13670	14340	17120
	55°	12390	13020	16220
	65°	10670	11150	14650
	75°	8254	8326	11460
	85°	5027	4321	2737

Polar Candela Chart

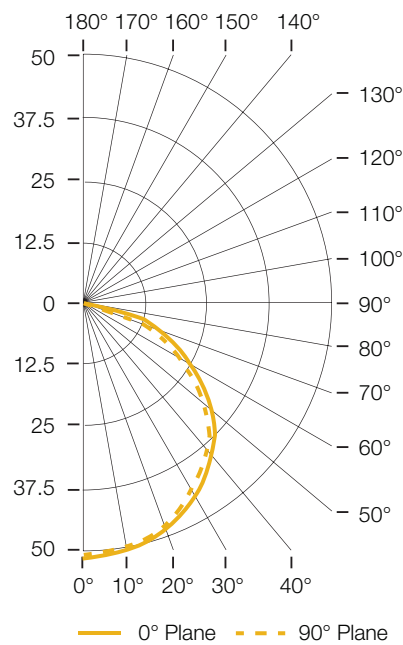

<sup>(2)</sup> Photometry based on (1) 98606SW(-xx) 1' length 12V LED Tape section in 3000°K.

## STEP 2 Select Connectors

### 2" Connector Cord

Connects two LED tape sections.  
Supplied with double sided tape.



Part Number	Finish	Dimensions
98650S-12	Black	L: 2" W: .5" H: .1875"

### 8' LED Connector Cord Direct Wire Cord

Use to wire LED tape to transformer.  
Includes 16 mounting clips.



Part Number	Finish	Dimensions
98662S-12	Black	L: 72" W: .5" H: .1875"

### 6" Connector Cord

Connects two LED tape sections.  
Includes 2 mounting clips.



Part Number	Finish	Dimensions
98651S-12	Black	L: 6" W: .5" H: .1875"

### Y Connector

Connector has one male and two female  
connectors. Supplied with mounting clips.



Part Number	Finish	Dimensions
98657S-12	Black	D: 4.25" H: .1875"

### 12" Connector Cord

Connects two LED tape sections.  
Includes 2 mounting clips.



Part Number	Finish	Dimensions
98652S-12	Black	L: 12" W: .5" H: .1875"

### X Connector

X connector has one male connector and  
three female connectors. Supplied with  
mounting clips.



Part Number	Finish	Dimensions
98658S-12	Black	D: 5" H: .1875"

### 18" Connector Cord

Connects two LED tape sections.  
Includes 3 mounting clips.



Part Number	Finish	Dimensions
98653S-12	Black	L: 18" W: .5" H: .1875"

### L Connector

Use when making right angled corners.



Part Number	Finish	Dimensions
98656S-12	Black	L: 1.312" H: 1.375" W: .25"

### 36" Connector Cord

Connects two LED tape sections or use for  
wiring to remote transformer.  
Includes 6 mounting clips.



Part Number	Finish	Dimensions
98654S-12	Black	L: 36" W: .5" H: .1875"

### End Cap

Covers open pins at the end of the run.

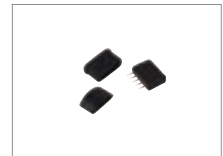

Part Number	Finish	Dimensions
98659S-12	Black	L: .5" W: .5" H: .125"

### 72" Connector Cord

Connects two LED tape sections or use for  
wiring to remote transformer.  
Includes 12 mounting clips.



Part Number	Finish	Dimensions
98655S-12	Black	L: 72" W: .5" H: .1875"



# STEP 3 Select Transformer

## Recommended Transformers

Ambiance Lx LED Tape Transformers come with an integral 10' output cord and 5-pin connector for powering an LED Tape System. The system is also compatible with all the Lx Transformers on pages 21-23.<sup>(1)</sup>

### LED Tape Plug-in Transformers

#### 60w 12V AC Zero Load

Includes 10' output cord to connect to LED tape sections. Supplied with 20 cord mounting clips.



Part Number	Finish	Dimensions
98050-12	Black	L: 3.3125" W: 1.5" H: 1.25"

Wattage: 0w – 60w Input: 120V AC | Output: 12V AC

#### 60w 24V AC Zero Load

Includes 10' output cord to connect to LED tape sections. Supplied with 20 cord mounting clips.



Part Number	Finish	Dimensions
98051-12	Black	L: 3.3125" W: 1.5" H: 1.25"

Wattage: 0w – 60w Input: 120V AC | Output: 24V AC

### LED Tape Hardwire Transformers

#### 100w 12V AC Zero Load

Includes terminal block on input side for 12/2 AWG Romex max. 10' output cable for connection to LED tape sections. Supplied with 20 cord mounting clips.



Part Number	Finish	Dimensions
98061-12	Black	L: 5" W: 1.594" H: 1"

Wattage: 0w – 100w Input: 120V AC | Output: 12V AC

#### 100w 24V AC Zero Load

Includes terminal block on input side for 12/2 AWG Romex max. 10' output cable for connection to LED tape sections. Supplied with 20 cord mounting clips.



Part Number	Finish	Dimensions
98062-12	Black	L: 5" W: 1.594" H: 1"

Wattage: 0w – 100w Input: 120V AC | Output: 24V AC

#### <sup>(1)</sup> Wiring LED Tape to Standard Transformer

Using an LED Tape Connector Cord, cut and remove the male end. Strip your 5 leads. Twist together the two leads on the left, twist together the two leads on the right, the center lead is not needed and may be trimmed. Wire normally to 12V or 24V output side of your transformer.

## Optional Components

### 10 pack of Cord Mounting Clips

Plastic clips for mounting connections.



Part Number	Finish	Dimensions
98647S-12	Black	L: .625" W: .375" H: .1875"
98647S-15	White	L: .625" W: .375" H: .1875"

### 10 pack of Tape Mounting Clips

Screw-in mounting clips for more durable LED tape installation or for mounting to uneven surfaces.



Part Number	Finish	Dimensions
98660S-98	Brushed Steel	L: .5" W: .5" H: .375"

### Miniature Wiring Compartment / Splicer

Polycarbonate splicer with cover for connection between transformer extension wire (i.e. Romex) and low voltage cable or LED Tape Connector. Maximum 25 amps.



Part Number	Finish	Dimensions
9459-12	Black	L: 2" W: .968" H: .625"
9459-15	White	L: 2" W: .968" H: .625"

### Fused Plug

For powering multiple Ambiance low voltage luminaires from an Lx Cable System. See page 92 for detailed wiring information.



Part Number	Finish	Dimensions
9488-12	Black	L: .875" W: .75" H: .812"
9488-15	White	L: .875" W: .75" H: .812"

Lx LED Tape System





# LED Disk Lighting

Ambiance® LED Disk Lights are a sleek, efficient and affordable way to enhance residential and commercial spaces. They provide homogenous light with a smooth, shadowless beam. Their versatility allows Ambiance® LED Disk Lights to be installed as a stand-alone luminaire, a system of multiple disk lights, or as an addition to an Ambiance® Lx Cable Lighting System.



## Configure Your System



### STEP 1

**Choose LED Disks**  
Select number of disks, housing color and color temperature needed for your project.

*page 36*



### STEP 2

**Select Connectors & Accessories**  
Order connection hubs, additional connector cords, extra cord mounting clips, wiring compartments and fused plugs needed for your installation. (Each disk includes a 36" linking cable.)

*page 37*



### STEP 3

**Select Transformers**  
Multiply the number of disks in your system by 4 watts to determine transformer size needed. LED disks are 12V AC for use with 12V power supplies.

*page 38*

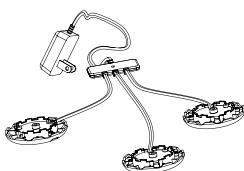

### KITS

Pre-packaged 2 and 3 light kits are available including a plug-in transformer and everything needed for a typical installation.

*page 39*



**Fused Plug**  
For connecting to Lx Cable System

*page 37*

# Design Guidelines

Ambiance® LED Disk Lighting is the high performance solution for spotlighting and direct illumination. Utilize the crisp and seamless beam spread of our LED chipsets to brighten your workspace or highlight areas of interest. With daisy chain or hub and spoke configuration options, placing light where you need it is a breeze.

In Cabinet

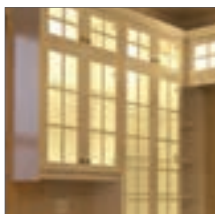

Under Cabinet



Task / Accent

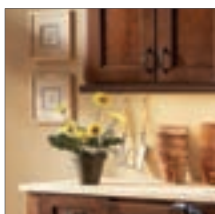

Niches

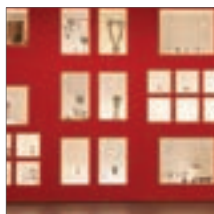

## Configuration Options

Daisy Chain

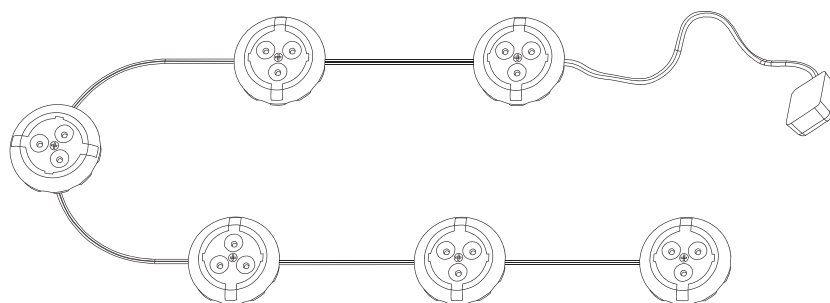

Hub and Spoke

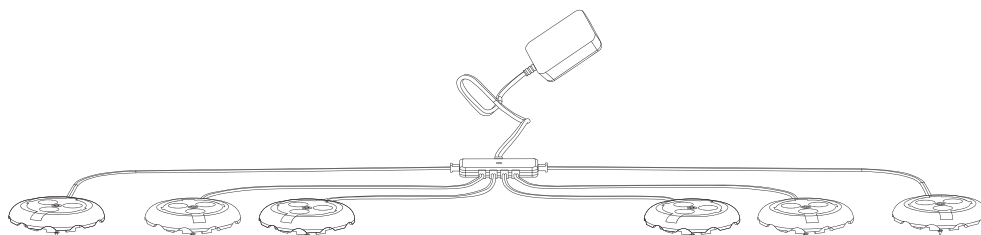

# STEP 1 Choose Disks

## Individual LED Disks\*

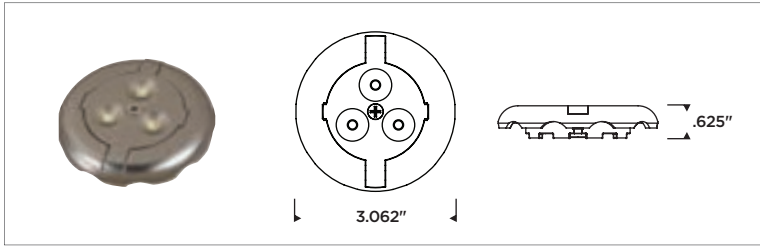

Ambiance LED Disk Lighting is ideal for residential, commercial and retail applications with its ample lumen output and versatility. The low-profile 12V LED Disks can easily be daisy-chain or hub-and-spoke linked to power a maximum of six disks on one transformer. Choose from plug-in or hardwire transformers, or power your disks from an Lx Cable System using our Fused Plug (9488).

Item Number	98859SW(-xx)	98860SW(-xx)
Color Temperature	2700°K	3000°K
Power Consumption	4 watts	4 watts
Lumens	160	170
Efficacy	40 lm/w	43 lm/w
Voltage	12V AC	
Color Rendering Index	>85 CRI	
Rated Average Life	40,000 hours to 70%	
Certification	cETL, damp rated	
Dimmable <sup>(1)</sup>	Yes	
Included Accessories	36" connector cord, three cord clips	
Optional Accessories	Connector cords, connection hub	
Material / Finish	(-12) Black, (-15) White, (-787) Bronze and (-986) Tinted Aluminum Low-profile, die-cast aluminum with captive screw and 36" linking cord	



<sup>(1)</sup> Ambiance LED Disks are dimmable on magnetic and electronic low voltage systems. For magnetic systems, a standard incandescent or magnetic low voltage (MLV) dimmer can be used. For electronic, an electronic low voltage (ELV) dimmer is recommended. See page 90 for more on dimming.

\* For pre-packaged kits, see page 39.

## Photometrics<sup>(2)</sup>

Zone (Degrees)	Lumens	% of Lamp
0° – 30°	56.7	32.5%
0° – 40°	93.4	53.6%
0° – 60°	157.7	90.4%
0° – 90°	174.4	100%
90° – 180°	0	0.0%
0° – 180°	174.4	100%

Average Luminance Table (cd/m<sup>2</sup>)

Vertical Angle (Degrees)	Horizontal Angle (Degrees)		
	0°	45°	90°
0°	60540	60540	60540
45°	58070	58070	58070
55°	48620	48620	48620
65°	32180	32180	32180
75°	1326	1326	1326
85°	0	0	0

Polar Candela Chart

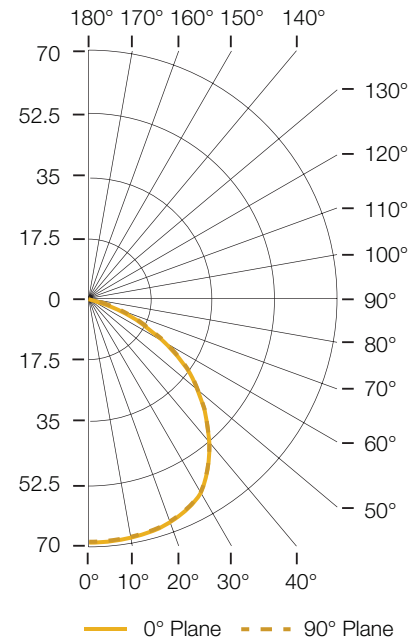

<sup>(2)</sup> Photometry based on (1) 98860SW(-xx) LED Disk in 3000°K CCT.

## STEP 2 Select Connectors & Accessories

### 6" Connector Cord

Connects LED Disk Lights together or to optional mounting hub. Can also be used for wiring to remote transformers.



Part Number	Finish	Dimensions
98643S-12	Black	L: 6" W: .5" H: .1875"
98643S-15	White	L: 6" W: .5" H: .1875"

### 10 pack of Cord Mounting Clips

Plastic clips for securing cables on install.



Part Number	Finish	Dimensions
98647S-12	Black	L: .625" W: .375" H: .1875"
98647S-15	White	L: .625" W: .375" H: .1875"

### 12" Connector Cord

Connects LED Disk Lights together or to optional mounting hub. Can also be used for wiring to remote transformers.



Part Number	Finish	Dimensions
98644S-12	Black	L: 12" W: .5" H: .1875"
98644S-15	White	L: 12" W: .5" H: .1875"

### Connection Hub

Includes one input port and 6 output ports for LED Disk Lights. 4 output ports front and one on each side. Mounting screw included.



Part Number	Finish	Dimensions
98641S-12	Black	L: 3" W: 1.25" H: .4375"
98641S-15	White	L: 3" W: 1.25" H: .4375"

### 18" Connector Cord

Connects LED Disk Lights together or to optional mounting hub. Can also be used for wiring to remote transformers.



Part Number	Finish	Dimensions
98645S-12	Black	L: 18" W: .5" H: .1875"
98645S-15	White	L: 18" W: .5" H: .1875"

### Miniature Wiring Compartment / Splicer

Polycarbonate splicer with cover for connection between transformer extension wire (i.e. Romex) and low voltage cable or LED Disk Connector. Maximum 25 amps.



Part Number	Finish	Dimensions
9459-12	Black	L: 2" W: .968" H: .625"
9459-15	White	L: 2" W: .968" H: .625"

### 10' Connector Cord

Connects LED Disk Lights together or to optional mounting hub. Can also be used for wiring to remote transformers.



Part Number	Finish	Dimensions
98646S-12	Black	L: 10' W: .5" H: .1875"
98646S-15	White	L: 10' W: .5" H: .1875"

### Fused Plug

For powering multiple Ambiance low voltage luminaires from an Lx Cable System. See page 92 for detailed wiring information.



Part Number	Finish	Dimensions
9488-12	Black	L: .875" W: .75" H: .812"
9488-15	White	L: .875" W: .75" H: .812"

## STEP 3 Select Transformer

### Recommended Electronic Transformers

The transformers listed below are our recommendations for use with the LED Disk Lighting system. The system is also compatible with all the 12V Lx Transformers on pages 21-23.<sup>(1)</sup>

#### Plug-in

##### 30w 12V AC *Zero Load*

Transformer consumes 1-1.5 watts. Includes on/off switch and 8' output cord for connection to first LED Disk Light in a row or optional connection hub.



Part Number	Finish	Dimensions
98640S-12	Black	L: 3.3125" W: 1.5" H: 1.25"
98640S-15	White	L: 3.3125" W: 1.5" H: 1.25"

Wattage: 0w – 30w Class II Input: 120V AC | Output: 12V AC

#### Hardwire

##### 60w AC Class II *Zero Load*

No minimum load required for operation. Ideal for 12V AC LED systems. UL 2108 flame resistant plastic enclosure. Includes wiring compartment with terminal block for 12/2 AWG max Romex type input and terminal block on opposite end for 10/2 AWG Ambiance® Lx cable output. Designed for in-line wiring, ideal for under cabinet mounting. For use with 12V AC Ambiance® products.



Part Number	Finish	Dimensions
96223S-12	Black	L: 5" W: 1.6" H: 1"
96223S-15	White	L: 5" W: 1.6" H: 1"

Wattage: 0w – 60w Class II Input: 120V AC | Output: 12V AC

#### <sup>(1)</sup>Wiring LED Disks to Transformer without Output Cord

Using an LED Disk Connector Cord, cut and remove the male end. Strip your cables and wire normally to 12V output side of your transformer.



## 2 and 3 Light LED Disk Kits

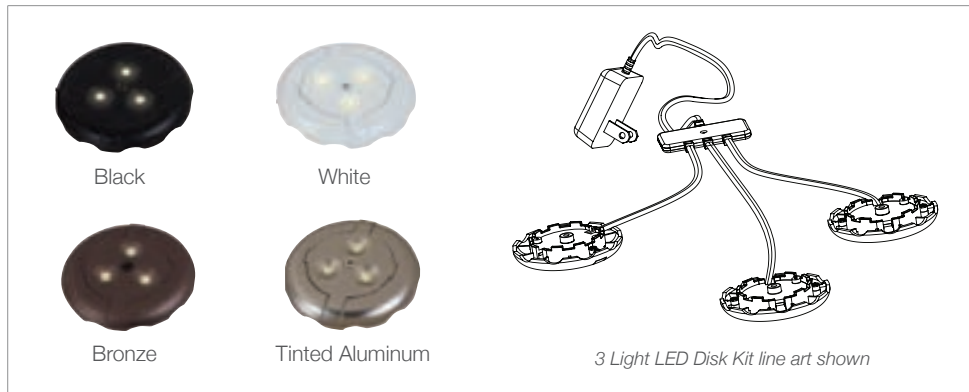

Our LED Disk Lighting Kits offer two and three light, all-in-one packages for added convenience. Each package includes a plug-in 12V 30 watt zero load transformer, a LED Disk Connection Hub and all necessary mounting components. Up to six LED Disk Lights can be powered from one transformer and connection hub.

Item Number	98852SW(-xx)	98853SW(-xx)	98862SW(-xx)	98863SW(-xx)
Number of Disks	Two	Three	Two	Three
Color Temperature	2700°K	2700°K	3000°K	3000°K
Total Power Consumption	8 watts	12 watts	8 watts	12 watts
Total Lumens	320	480	340	510
Efficacy	40 lm/w	40 lm/w	43 lm/w	43 lm/w
Voltage	12V AC			
Color Rendering Index	>85 CRI			
Rated Average Life	40,000 hours to 70%			
Certification	cETL, damp rated			
Dimmable <sup>(1)</sup>	Yes			
Included Accessories	12V AC 30w Plug-in Transformer, LED Disk Connection Hub			
Material / Finish	(-12) Black, (-15) White, (-787) Bronze and (-986) Tinted Aluminum Low-profile, die-cast aluminum with captive screw and 36" linking cord			

<sup>(1)</sup> Ambiance LED Disks are dimmable on magnetic and electronic low voltage systems. For magnetic systems, a standard incandescent or magnetic low voltage (MLV) dimmer can be used. For electronic, an electronic low voltage (ELV) dimmer is recommended. See page 90 for more on dimming.

## Mounting Options

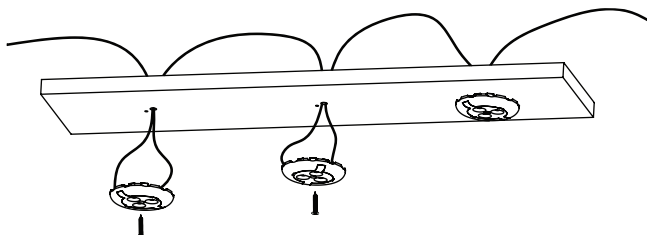

Surface mount via captive screw

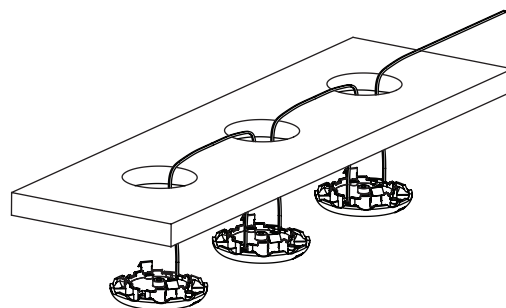

Recessed Mount via 2 3/8" diameter hole

# Xenon Disk Lighting

Ambiance® Disk Lighting offers functional and low-profile lighting while enhancing the appeal of your space. Disk lights can easily be surface or recess mounted. Optional trims help create a variety of lighting effects and reduce glare. Ambiance® Disk Lights can use 12V or 24V xenon or incandescent lamping and can be installed as stand-alone luminaires or added to any Class I Ambiance® Lx Cable Lighting System using our Fused Plugs (9488).



## Configure Your System



### STEP 1

**Choose Disks & Lamps**  
Select beam spread, number of disks, desired housing color and lamps based on the requirements of your project.

*page 42*



### STEP 2

**Select Optional Trims**  
Order any desired trims and diffusers for glare control or lamp coverage.

*page 44*

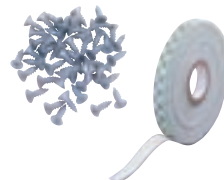

### STEP 3

**Choose Wiring Accessories**  
Disk lights are supplied with a cord and plug. Additional accessories are available for larger installations or connecting to existing systems.

*page 44*



### STEP 4

**Select Transformers**  
Multiply the watts consumed per lamp by the number of lamps to determine transformer size. Use transformer 98175 to easily wire multiple 9858 disks using included plug output cords.

*page 45*



### KITS

Pre-packaged two, three and five light kits are available including lamps, plug-in transformer and everything needed for a typical installation.

*page 46*



**Fused Plug**  
For connecting to Lx Cable System  
*page 44*

# Design Guidelines

Our low-profile, traditional disk lighting allows you to shape the light just the way you need it. Choose from narrow or wide beam spreads and a variety of optional trims to create a one-of-a-kind look. Whether your goal is accent or task lighting, Ambiance® Disk Lights are a go-to choice for adding form and function.

In Cabinet



Under Cabinet



Task / Accent

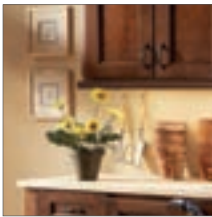

Niches

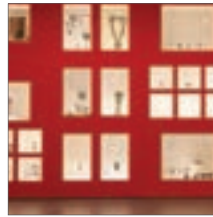

## Configuration Options

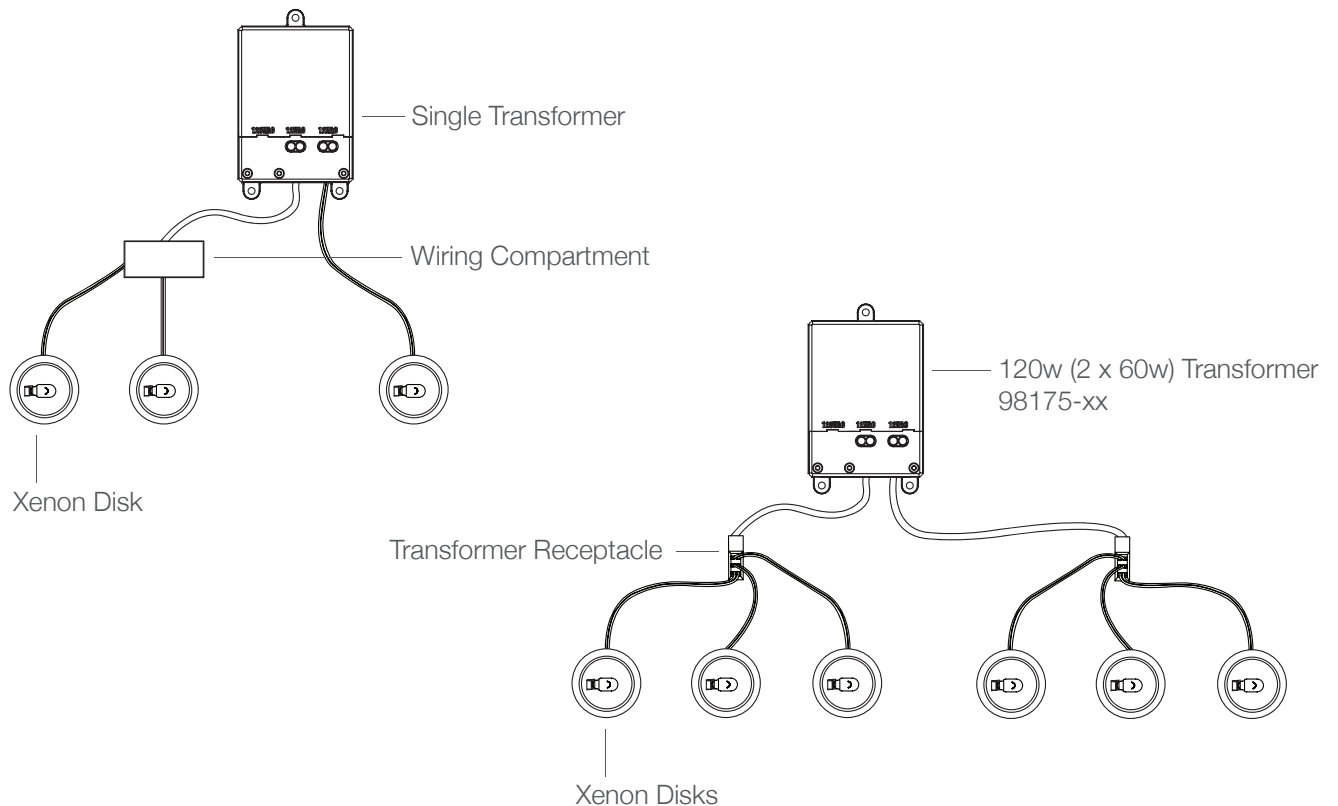

# STEP 1 Choose Disks & Lamps

## Individual Xenon Disk Lights\*

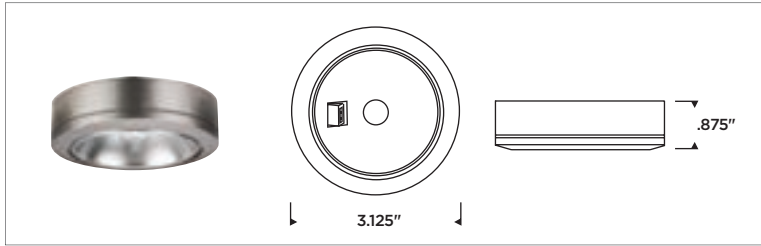

Ambiance Disk Lighting offers functional and low-profile lighting, while enhancing the appeal of any space. Disk lights easily install as surface mount or recessed for a lower profile. Optional trims are also available for a variety of lighting effects and glare reduction. Ambiance Disk Lights should be used with a Class II transformer, or a Class I transformer with our Fused Plug (9488), track, and cable.

Item Number	9485(-xx)	9858(-xx)
Reflector	Multi-faceted polished aluminum	Satin aluminum
Beam Spread	NFL 24°, Accent	FL 40°, Task
Voltage	12V and 24V	
Lamp Type	T5 Wedge	
Max. Wattage	(1) 18 watt incandescent or xenon	
Certification (Optional lens not required for listing)	cETL, damp location	
Included Accessories	36" 18/2 cord, surface mount ring and mounting screws	80" 18/2 cord & plug, surface mount ring and mounting screws
Material / Finish	(-12) Black, (-15) White, (-171) Bronze and (-962) Brushed Nickel Low-profile, polycarbonate housing	



Black



White



Antique Bronze



Brushed Nickel

\* For pre-packaged kits, see page 46.

## Lamping Options

Item Number	9774	9775	9776	9777	9778
Lamp Type	T5 Xenon	T5 Xenon	T5 Incandescent	T5 Incandescent	T5 Incandescent
Color Temperature	2800°K	2800°K	2650°K	2750°K	2800°K
Voltage	12V AC	24V AC	12V AC	12V AC	12V AC
Rated Watts	18 watts	18 watts	8 watts	12 watts	18 watts
Power Consumption	16.2 watts	16.2 watts	8 watts	11.6 watts	16.2 watts
Lumens	210	210	57	120	210
Efficacy	13 lm/w	13 lm/w	7 lm/w	10 lm/w	13 lm/w
Rated Average Life	10,000 hours	2,000 hours	2,500 hours	2,000 hours	2,000 hours
Lamp Base	Wedge				
Min. Spacing	6" on center				
Color Rendering Index	>90 CRI				
Dimmable	Yes				

# STEP 1 Choose Disks & Lamps

## Photometrics

9485 Photometrics using 9774 T5 Wedge Base Lamp

Distance from Source	Diameter in Feet	Footcandles
1.5'	.6	267
2'	.9	150
3'	1.3	67
4'	1.7	38
6'	2.6	17
8'	3.4	9
10'	4.3	6

9858 Photometrics using 9774 T5 Wedge Base Lamp

Distance from Source	Diameter in Feet	Footcandles
1.5'	1.1	68
2'	1.5	42
3'	2.2	19
4'	2.9	11
6'	4.0	5
8'	5.8	3
10'	7.3	2

## Application Guide

### Choosing a Beam Spread

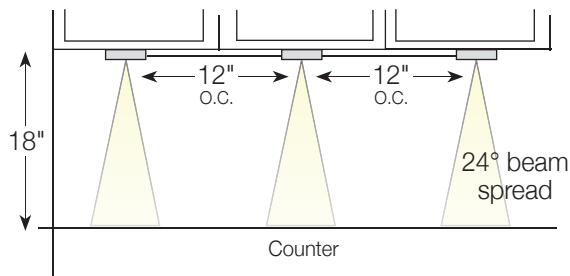

Accent lighting

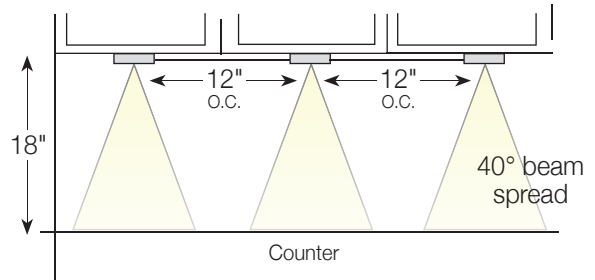

Task lighting

### How to Mount Our Disk Lights

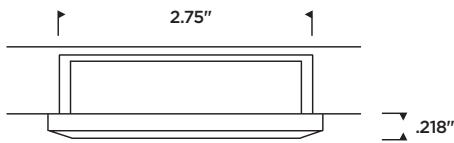

Recessed mount via 2¾" diameter hole

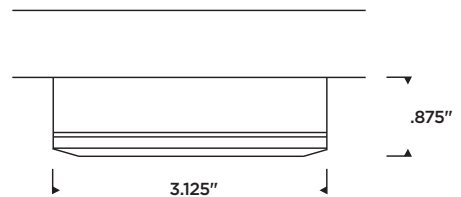

Surface mount via included surface mount ring

## STEP 2 Select Optional Trims

### Glass Diffuser Trim

Etched glass diffuser trim provides soft illumination. Ideal for use in food preparation areas or where lamp cover is recommended. Glass shield not required for listing.

Part Number	Finish	Dimensions
9414-12	Black	D: 2.5" H: .25"
9414-15	White	D: 2.5" H: .25"
9414-33	Etched	D: 2.5" H: .25"
9414-171	Antique Bronze	D: 2.5" H: .25"
9414-962	Brushed Nickel	D: 2.5" H: .25"



### Twist-On Eyelid Trim

Polycarbonate twist-on eyelid trim shields glare while providing maximum light output.

Part Number	Finish	Dimensions
9451-12	Black	D: 2.5" H: .75"
9451-15	White	D: 2.5" H: .75"
9451-171	Antique Bronze	D: 2.5" H: .75"
9451-962	Brushed Nickel	D: 2.5" H: .75"



### Twist-On Honeycomb Trim

Polycarbonate twist-on honeycomb louver trim provides a 45° glare cut-off.

Part Number	Finish	Dimensions
9452-12	Black	D: 2.5" H: .25"
9452-15	White	D: 2.5" H: .25"
9452-171	Antique Bronze	D: 2.5" H: .25"
9452-962	Brushed Nickel	D: 2.5" H: .25"



## STEP 3 Select Wiring Accessories

### Fused Plug

For powering multiple Ambiance low voltage luminaires from an Lx Cable System. See page 92 for detailed wiring information.



Part Number	Finish	Dimensions
9488-12	Black	L: .875" W: .75" H: .812"
9488-15	White	L: .875" W: .75" H: .812"

### Miniature Wiring Compartment / Splicer

Polycarbonate splicer with cover for connection between transformer extension wire (i.e. Romex) and low voltage cable or Xenon Disk Connector.



Part Number	Finish	Dimensions
9459-12	Black	L: 2" W: .968" H: .625"
9459-15	White	L: 2" W: .968" H: .625"

**NOTE:** Refer to page 18-19 for additional Lx Cable System accessories that can be used with these disk lights.

# STEP 4 Select Transformer

## Recommended Electronic Transformers

Our electronic transformers have soft-start circuitry that increases lamp life. They emit no audible noise, employ automatically resetting short circuit protection, are UL and cUL Listed, moisture and shock resistant and are dimmable. We recommend the transformers listed below, however, our disks are also compatible with all the Lx Transformers on pages 21-23.

### Hardwire 12V Electronic Transformers

#### 120w (2 x 60w) AC Dual Class II

UL 2108, flame resistant plastic enclosure. Includes terminal block for one 10/2 AWG max. Romex input and two Class II 60w outputs up to 10 AWG wire.



Part Number	Finish	Dimensions
<b>98176-12</b>	Black	L: 5" W: 3.25" H: 1"
<b>98176-15</b>	White	L: 5" W: 3.25" H: 1"

Wattage: 2 x (15w - 60w) Class II Input: 120V AC | Output: 12V AC

### Plug-in 12V Electronic Transformers

#### 120w (2 x 60w) AC Dual Class II

UL 2108, flame resistant plastic enclosure. Complete with 8 foot, 18/2 cord, quick connect plug and in-line on/off switch for easy attachment to input cable. Includes two Class II 60w outputs with three receptacles for 9858 disk lights on each output.



Part Number	Finish	Dimensions
<b>98175-12</b>	Black	L: 5" W: 3.25" H: 1"
<b>98175-15</b>	White	L: 5" W: 3.25" H: 1"

Wattage: 2 x (15w - 60w) Class II Input: 120V AC | Output: 12V AC

# KITS

## 2, 3 and 5 Light Xenon Disk Kits



Our Xenon Disk Light Kits offer two, three and five light, all-in-one packages of our 9858 task disks. Each package comes complete with a 12V 120w (2 x 60w) plug-in transformer, 18 watt xenon T5 lamps and all necessary mounting components. The included 80" cords allow for reaching remote locations from one transformer.

3 Light Disk Kit shown

Item Number	9888(-xx)	9889(-xx)	9890(-xx)
Number of Disks	Two 9858 disks	Three 9858 disks	Five 9858 disks
Rated Watts	36 watts	54 watts	90 watts
Total Power Consumption	32.4 watts	48.6 watts	81 watts
Total Lumens	420 total	630 total	1050 total
Efficacy	13 lm/w		
Reflector & Beam Spread	Satin Aluminum, FL 40° Task		
Voltage	12V		
Lamps Included	9774 - 12V 18 watt xenon T5 wedge base		
Color Temperature	2800°K		
Color Rendering Index	>90 CRI		
Rated Average Life	10,000 hours		
Certification (Optional lens not required for listing)	cETL, damp location		
Dimmable	Yes		
Included Accessories	Plug-in transformer, 80" cords for disk plug outlet, disk plug outlet, rotary switch, surface mount rings and mounting screws		
Material / Finish	(-12) Black, (-15) White, (-171) Antique Bronze and (-962) Brushed Nickel Low-profile, polycarbonate housing		





Disk Lighting system





# Self-Contained Lighting

Ambiance® Self-Contained Lighting is offered in a variety of light sources and configurations to meet any application. Choose from line and low-voltage LED, 120V Xenon and 120V fluorescent light sources. Each self-contained unit combines low-profile illumination with highly efficient design. All are linkable and available in multiple lengths to match your space considerations.



## Select Your System



### Self-Contained 120V LED

Choose from 2700°K or 3000°K color temperatures in 12 or 18 inch lengths. Hardwire to your power source or dimmer, no transformer needed.

*page 52*



### Self-Contained 24V DC LED

Available in 3000°K color temperature in multiple lengths and finishes. Choose from a variety of connector lengths to join units together. Select a hardwire or plug-in transformer and add a dimmer, if desired.

*page 54*



### Self-Contained 120V Xenon

Specify your desired length and finish. Choose from a variety of connector lengths to join units together. Power with the optional plug-in cord or direct wire with the included conduit adapter.

*page 58*

# Design Guidelines

Ambiance® Self-Contained Lighting offers a variety of light sources and systems to complement any application. Choose from LED in either line or low-voltage, xenon or fluorescent. Each unit is low-profile and best of class in performance to meet your design criteria.

Under Cabinet



Task

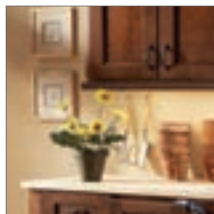

Wall Mount\*



\* (Self-Contained High Output Fluorescent only)



## Self-Contained High Output Fluorescent

Specify your desired length and finish. Mount to the wall or under-cabinet. Hardwire to your power source. Integral on/off switch included.

*page 60*



## Self-Contained Fluorescent

Specify your desired length. Hardwire to your power source. Optional on/off switch available for individual control.

*page 62*

# Self-Contained 120V LED Lighting

## System Overview

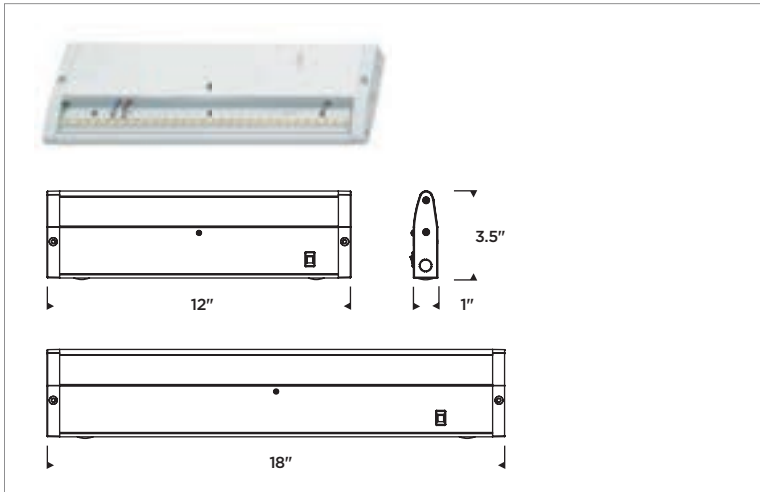

Ambiance Self-Contained 120V LED Lighting easily conceals under cabinets and in other areas where you need task lighting. They are available in a white finish in both 12 and 18 inch lengths and color temperatures of 2700°K or 3000°K. Their high lumen output is coupled with uniform distribution thanks to a tightly clustered array of 30-45 premium LED chip packages. The on-board power supply is dimmable down to 15% with electronic low voltage (ELV) and standard TRIAC dimmers. Multiple knockouts are provided along with a conduit adapter for easy link-ability and wiring for power.

Item Number	98593SW-15	98594SW-15	98595SW-15	98596SW-15
Size	12" Length	18" Length	12" Length	18" Length
Color Temperature	2700°K		3000°K	
Power Consumption	8.5 watts	12.75 watts	8.5 watts	12.75 watts
Lumens	545	817	545	817
Efficacy	64 lm/w			
Voltage	120V AC			
Min. Spacing	Adjacent mounting capable			
Color Rendering Index	>80 CRI			
Rated Average Life	50,000 hours to 70%			
Certification	cETL, damp location			
Dimmable <sup>(1)</sup>	Yes to 15%			
Included Accessories	Conduit cable adapter, direct wire knockouts at back and sides			
Material / Finish	(-15) White Low profile, self-cooling aluminum housing with local on/off switch, clear acrylic lens			

<sup>(1)</sup> Ambiance Self-Contained 120V LED Lights have an integrated power supply, which is dimmable down to 15% using a standard TRIAC or electronic low-voltage (ELV) dimmer. Dimmer capacities must be de-rated to 75% of total allowable wattage to compensate for LED in-rush current.

# Self-Contained 120V LED Lighting

## Photometrics<sup>(2)</sup>

Zonal Lumen Summary

Zone (Degrees)	Lumens	% of Lamp
0° – 30°	159	29.22%
0° – 40°	261	47.83%
0° – 60°	454	83.29%
0° – 90°	544	99.79%
90° – 180°	1	0.21%
0° – 180°	545	100%

Average Luminance Table (cd/m<sup>2</sup>)

		Horizontal Angle (Degrees)		
		0°	45°	90°
Vertical Angle (Degrees)	0°	23067	23067	23067
	45°	21840	21955	21779
	55°	20832	20596	20853
	65°	17871	18523	18930
	75°	11759	14259	14865
	85°	3880	7261	8050

Polar Candela Chart

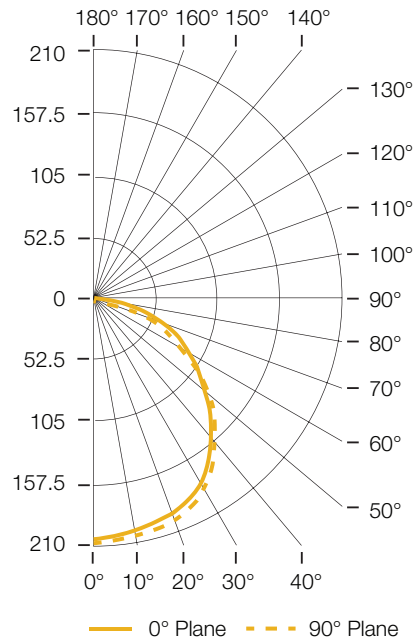

<sup>(2)</sup> Photometry based on (1) 98595SW-15 12" LED Light in 3000°K CCT

## Application Guide

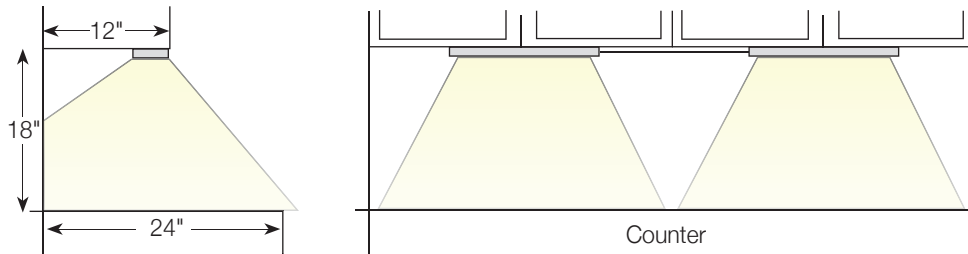

# STEP 1 Choose Fixtures

## Self-Contained 24V DC LED Lighting

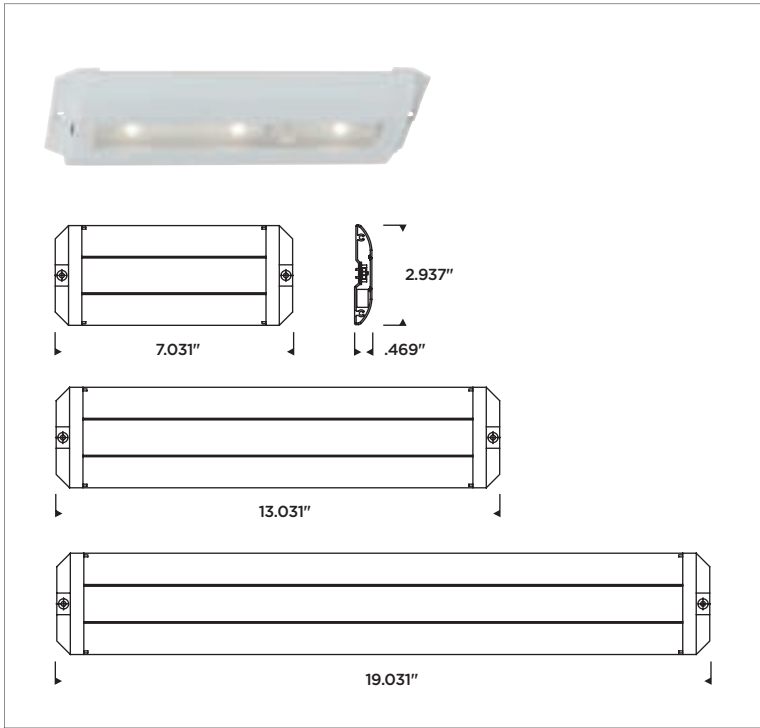

Ambiance Self-Contained 24V DC LED Lighting combines high function with efficient design. Each fixture is just ½" high and delivers 300 lumens per foot. Units are linkable to one another for longer runs and include local on/off switches for individual control. Dimmable with 4-step dimming switch (98622S). Choose from a 30 watt plug-in or a remote mounted 60 watt power supply.



White



Plated Bronze



Tinted Aluminum

Item Number	98600SW(-xx)	98601SW(-xx)	98602SW(-xx)
Size	7" Length	13" Length	19" Length
Rated Watts <sup>(1)</sup>	4.5 watts	8 watts	12 watts
Power Consumption <sup>(2)</sup>	5.2 watts	8.8 watts	13.9 watts
Lumens	180	360	550
Efficacy	35 lm/w	41 lm/w	40 lm/w
Color Temperature	3000°K		
Voltage	24V DC		
Min. Spacing	Adjacent mounting capable		
Color Rendering Index	>85 CRI		
Rated Average Life	40,000 hours to 70%		
Certification	cETL, damp location		
Dimmable <sup>(3)</sup>	Yes		
Optional Accessories	Connector cords, cord clips, power supplies and 4-step dimming switch		
Material / Finish	(-15) White, (-787) Plated Bronze and (-986) Tinted Aluminum Low-profile, self-cooling aluminum housing with local on/off switch		

<sup>(1)</sup> Wattage consumed by fixture only.

<sup>(2)</sup> Wattage consumed by fixture and driver.

<sup>(3)</sup> Ambiance 24V DC LED Lighting is dimmable using our Four-Step Master Dimming Switch (98622S-xx). Dim a single fixture or run of fixtures to 75, 50 and 25 percent of initial light levels by placing the switch anywhere in a run.



# STEP 1 Choose Fixtures

## Photometrics<sup>(2)</sup>

**Zonal Lumen Summary**

Zone (Degrees)	Lumens	% of Lamp
0° – 30°	181.7	32.9%
0° – 40°	296.4	53.6%
0° – 60°	488.0	88.3%
0° – 90°	552.8	100%
90° – 180°	0	0.0%
0° – 180°	552.8	100%

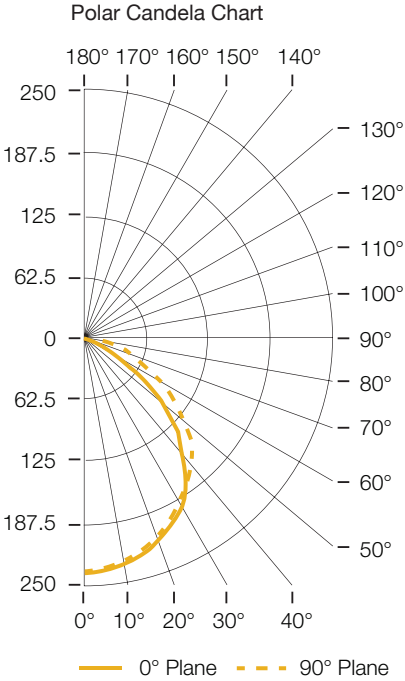

**Average Luminance Table (cd/m<sup>2</sup>)**

		Horizontal Angle (Degrees)		
		0°	45°	90°
Vertical Angle (Degrees)	0°	23580	23580	23580
	45°	18330	20950	22390
	55°	10840	15930	20700
	65°	5697	9930	16310
	75°	3632	5957	9430
	85°	3027	3973	3973

<sup>(2)</sup> Photometry based on 98602SW(-xx), 19" length LED Light

## Application Guide

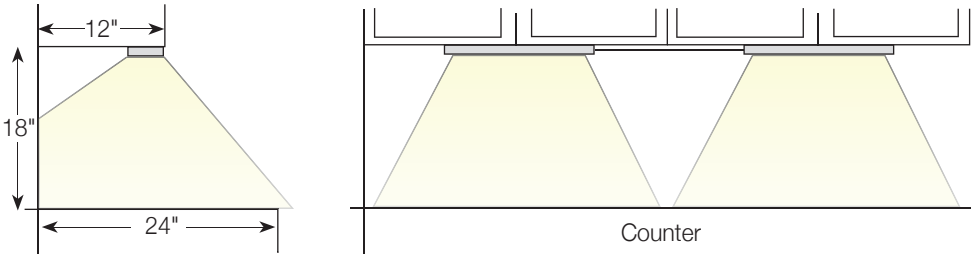

## STEP 2 Choose Connectors & Clips

### 6" Connector Cord

Connects two units together and connects hardwire 60w 24V DC power supply to the first unit in a run.



Part Number	Finish	Dimensions
98627S-12	Black	L: 6"
98627S-15	White	L: 6"

### 24" Connector Cord

Connects two units together and connects hardwire 60w 24V DC power supply to the first unit in a run.



Part Number	Finish	Dimensions
98631S-12	Black	L: 24"
98631S-15	White	L: 24"

### 12" Connector Cord

Connects two units together and connects hardwire 60w 24V DC power supply to the first unit in a run.



Part Number	Finish	Dimensions
98628S-12	Black	L: 12"
98628S-15	White	L: 12"

### 10' Connector Cord

Connects two units together and connects hardwire 60w 24V DC power supply to the first unit in a run.



Part Number	Finish	Dimensions
98630S-12	Black	L: 120"
98630S-15	White	L: 120"

### 18" Connector Cord

Connects two units together and connects hardwire 60w 24V DC power supply to the first unit in a run.



Part Number	Finish	Dimensions
98629S-12	Black	L: 18"
98629S-15	White	L: 18"

### Clips

Package of 10 clips. Use for cord retention. Recommended use: 2 clips per foot.



Part Number	Finish	Dimensions
98647S-12	Black	L: .625" W: .375" H: .1875"
98647S-15	White	L: .625" W: .375" H: .1875"

## STEP 3 Choose DC Power Supply & Controls

### Plug-in LED Power Supply

Includes 6' output connector cord that plugs directly into an LED fixture. 24V DC 30w.



Part Number	Finish	Dimensions
98623S-12	Black	L: 3" W: 1.75" H: 1.375"

### Hardwire LED Power Supply

Includes direct wiring compartment on 120v side. Output port on low voltage side accepts LED connector cords. 24V DC 60w.



Part Number	Finish	Dimensions
98620S-12	Black	L: 6.75" W: 3" H: 1.375"
98620S-15	White	L: 6.75" W: 3" H: 1.375"

### Four-Step Master Dimming Switch

Dims a single LED fixture or run of fixtures to 75%, 50% and 25% of initial light levels anywhere in a run. Consumes 1 watt. Controls up to 60w.



Part Number	Finish	Dimensions
98622S-12	Black	L: 2.875" W: 2.093" H: .531"
98622S-15	White	L: 2.875" W: 2.093" H: .531"



Self-Contained Lighting

# STEP 1 Choose Fixtures

## Self-Contained 120V Xenon Lighting

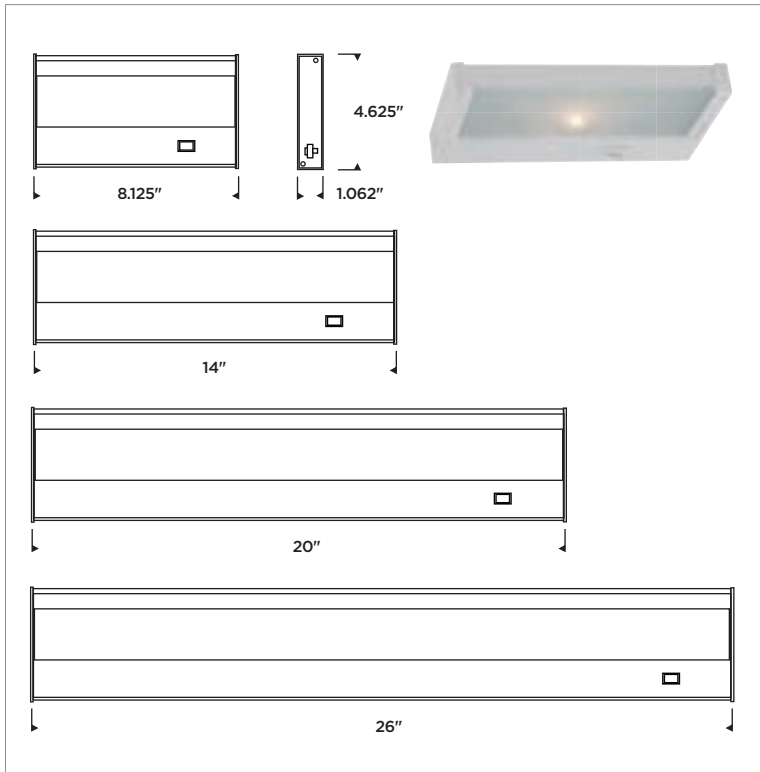

Ambiance Self-Contained 120V Xenon Lighting is the perfect combination of best-in-class performance and ease of installation. Our Self-Contained Xenon Lights are fully dimmable and are equipped with a hinged glass diffuser for easy cleaning and relamping. Link units together in a continuous run of up to 560 watts using connector cords and direct wire using conduit adapter, or plug-in with 5' power cord and plug (connector cords and power cord sold separately, conduit adapter included.)



White



Plated Bronze



Tinted Aluminum

Item Number	98040(-xx)	98041(-xx)	98042(-xx)	98043(-xx)
Number of Lamps	One	Two	Three	Four
Size	8" Length	14" Length	20" Length	26" Length
Rated Watts	35 watts	70 watts	105 watts	140 watts
Raw Lumens <sup>(1)</sup>	420	840	1260	1680
Efficacy	12 lm/w			
Diffuser	Hinged frosted glass lens			
Lamps Included	120V T4 35 watt xenon G-9			
Color Temperature	2650°K			
Voltage	120V AC			
Color Rendering Index	>90 CRI			
Rated Average Lamp Life	2,000 hours			
Certification	cETL, damp location			
Dimmable <sup>(2)</sup>	Yes			
Min. Spacing	Adjacent mounting capable			
Optional Accessories	Master switch, 5' power cord w/plug, connector cords for linking up to 560 watts of Xenon fixtures			
Included Accessories	Conduit adapter, mounting screws			
Material / Finish	(-15) White, (-787) Plated Bronze and (-986) Tinted Aluminum Low-profile aluminum housing with multiple knockouts and local hi/low/off switch			

<sup>(1)</sup> Raw lumen level is derived from lamp source output. Some illumination is lost through diffuser. Actual light delivered to surface will be less.

<sup>(2)</sup> Ambiance Self-Contained 120V Xenon Lights are dimmable using standard incandescent dimmers. Each unit also includes an integral hi/low/off switch for multiple levels of illumination from standard wiring.

## STEP 2 Select Connectors

### 6" Connector Cord

Link up to 560w max of Self-Contained 120v Xenon Lights from a single power feed.



Part Number	Finish	Dimensions
90842-12	Black	L: 6"
90842-15	White	L: 6"

### 18" Connector Cord

Link up to 560w max of Self-Contained 120v Xenon Lights from a single power feed.



Part Number	Finish	Dimensions
90844-12	Black	L: 18"
90844-15	White	L: 18"

### 12" Connector Cord

Link up to 560w max of Self-Contained 120v Xenon Lights from a single power feed.



Part Number	Finish	Dimensions
90843-12	Black	L: 12"
90843-15	White	L: 12"

## STEP 3 Choose Power Cord & Controls

### 5' Power Cord & Plug

5 ft. power cord & plug for Self-Contained 120V Xenon Lights. Link up to 560w of Xenon fixtures with available connector cords and then connect the power cord and plug to the first fixture in your run to energize. Ambiance Self-Contained 120V Xenon Lights can also be hard-wired for power using the included conduit adapter.



Part Number	Finish	Dimensions
90845-12	Black	L: 6.75" W: 3" H: 1.375"
90845-15	White	L: 6.75" W: 3" H: 1.375"

### Master Switch

Each Self-Contained 120V Xenon Light features an integral on/off switch for individual control. Utilize this 120V master switch to control a group or run of Xenon fixtures. The master switch can be hard-wired or powered with the 98045(-xx) power cord. A 120V Xenon connector cord receptacle is integrated to the master switch for easy connection to a run of fixtures.



Part Number	Finish	Dimensions
90846-12	Black	L: 4.72" W: 4.656" H: 1.06"
90846-15	White	L: 4.72" W: 4.656" H: 1.06"

## Replacement Lamp

### 120V 35w Xenon Lamp

120V T4 35w max. Xenon G-9 lamp. For replacement in Self-Contained 120V Xenon Lighting.

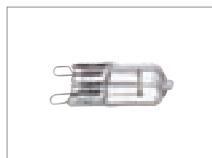

Part Number	Finish	Dimensions
97190-32	Clear	D: .5" L: 2.0625"

# Self-Contained High Output Fluorescent Lighting

## System Overview

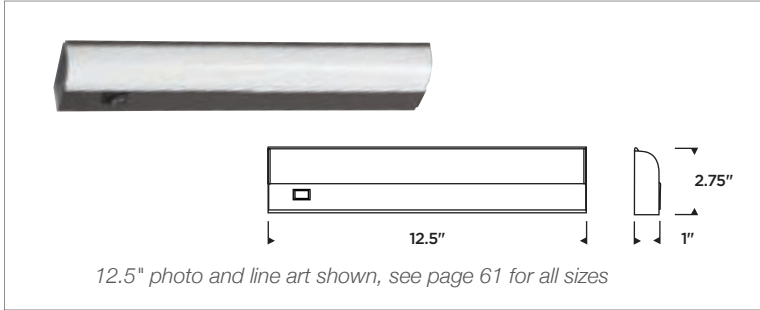

Ambiance Self-Contained High Output Electronic T5 Lighting is ideal for confined areas and commercial applications. They include a premium 4100°K T5 lamp that produces 40% more light and lasts two times longer than standard T5s. An integral on/off switch, multiple knockouts and a hinged ballast cover are included for easy installation. UL suitable for wall mounting.

Item Number	49090BL(-xx)	49091BL(-xx)	49092BL(-xx)	49093BL(-xx)
Size	12.5" Length	23" Length	34.5" Length	46.5" Length
Power Consumption	8 watts	14 watts	21 watts	28 watts
Raw Lumens <sup>(1)</sup>	460	1140	1850	2470
Efficacy	57.5 lm/w	81 lm/w	88 lm/w	88 lm/w
Diffuser	Frosted ribbed acrylic			
Lamp Included	One NPF High Output T5			
Color Temperature	4100°K			
Voltage	120V AC			
Color Rendering Index	>82 CRI			
Rated Average Lamp Life	10,000 hours			
Certification	UL/cUL, damp locations			
Dimmable	No			
Min. Spacing	Adjacent mounting capable, wall, ceiling or under cabinet			
Included Accessories	Conduit adapter			
Material / Finish	(-15) White, (-171) Painted Antique Bronze and (-760) Painted Stainless Low-profile aluminum housing with multiple knockouts and local on/off switch			

<sup>(1)</sup> Raw lumen level is derived from lamp source output. Some illumination is lost through diffuser. Actual light delivered to surface will be less.

# Self-Contained High Output Fluorescent Lighting

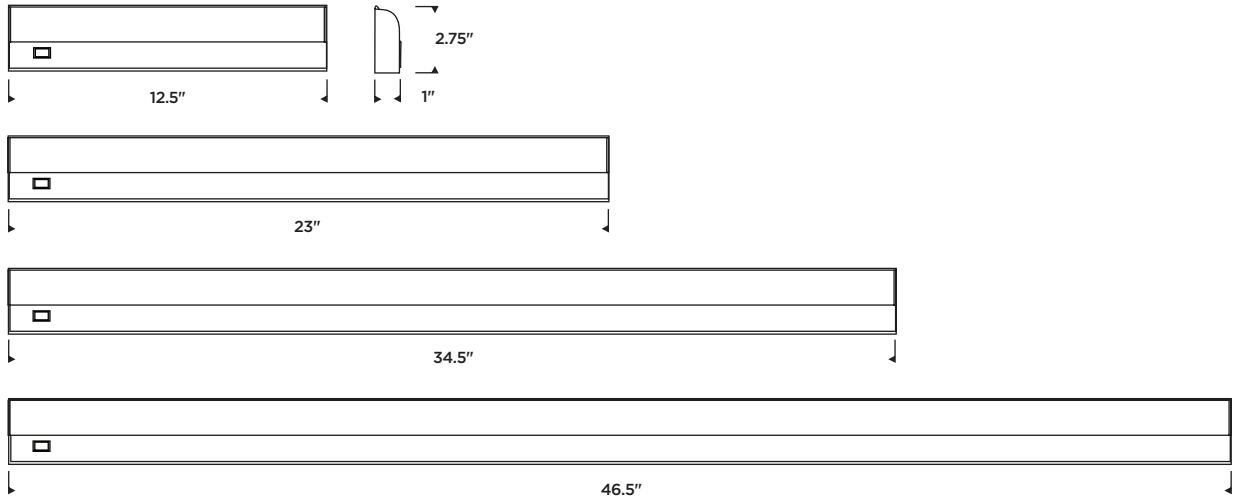

White



Painted  
Antique Bronze



Painted  
Stainless

# Self-Contained Fluorescent Lighting

## Self-Contained Fluorescent Lighting

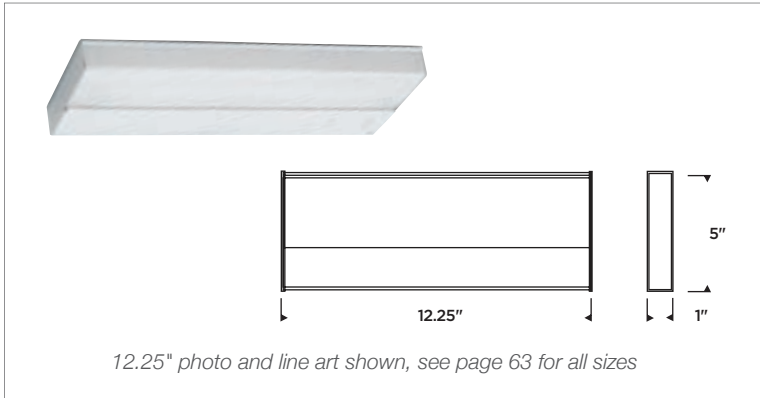

Ambiance Self-Contained Fluorescent Lighting is designed with quality and performance in mind. The low profile design is optimal for confined areas. High performance electronic ballasts and T5 lamps provide instant-on, flicker-free light. Contains multiple knockouts for ease of installation and linking units together.

Item Number	4975BLE-15	4976BLE-15	4977BLE-15	4978BLE-15	4979BLE-15
Size	12.25" Length	21.25" Length	24.5" Length	33.5" Length	42.5" Length
Power Consumption	8 watts	13 watts	16 watts	21 watts	26 watts
Raw Lumens <sup>(1)</sup>	390	855	780	1245	1710
Efficacy	49 lm/w	66 lm/w	49 lm/w	59 lm/w	66 lm/w
Lamps Included	One 8w T5	One 13w T5	Two 8w T5	One 8w & One 13w T5	Two 13w T5
Diffuser	Stay-white, ribbed acrylic				
Color Temperature	3000°K				
Voltage	120V AC				
Color Rendering Index	>82 CRI				
Rated Average Lamp Life	10,000 hours				
Certification	UL/cUL, damp location				
Dimmable	No				
Min. Spacing	Adjacent mounting capable				
Optional Accessories	Rocker on/off switch for individual control (9027-15)				
Material / Finish	(-15) White Low-profile aluminum housing with multiple knockouts for wiring and optional on/off switch				

<sup>(1)</sup> Raw lumen level is derived from lamp source output. Some illumination is lost through diffuser. Actual light delivered to surface will be less.



# Self-Contained Fluorescent Lighting

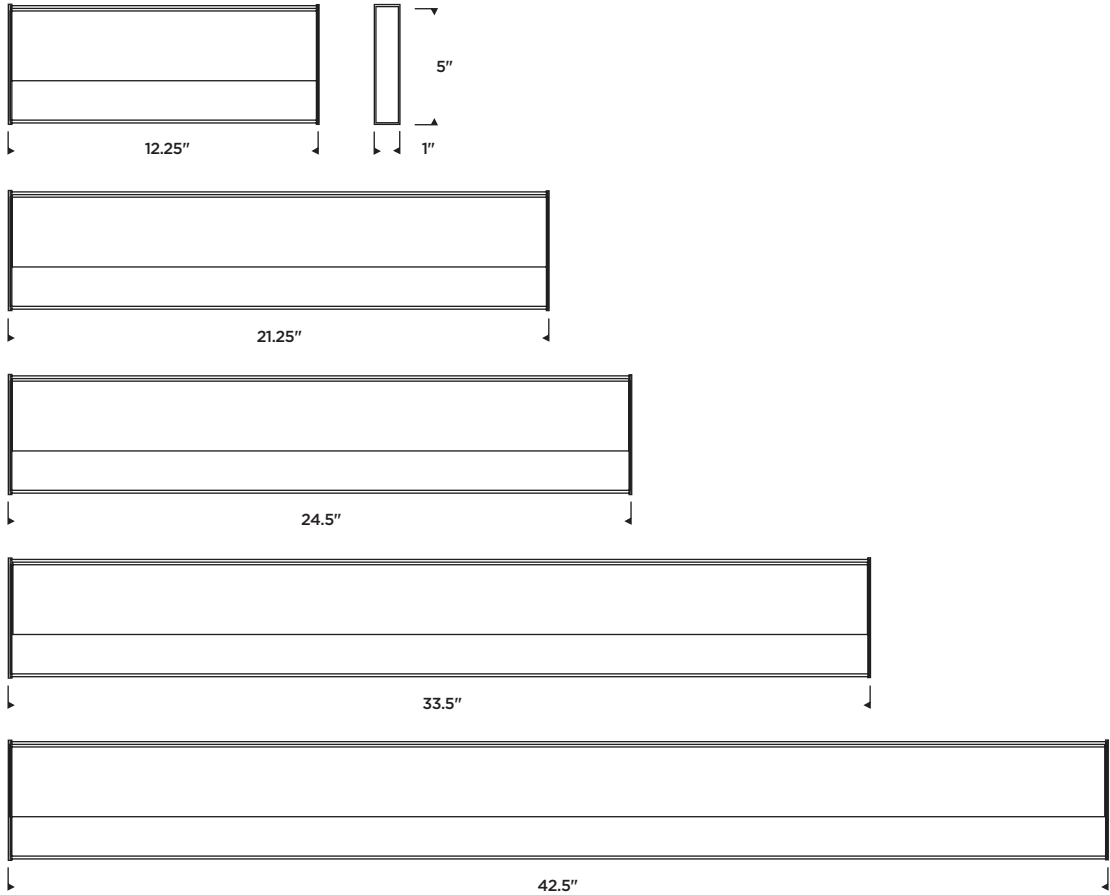

Self-Contained Lighting

## Optional Accessories

### Optional On/Off Switch

Snaps into switch knock out on Self-Contained Fluorescent fixtures.



Part Number	Finish	Dimensions
9027-15	White	Fits Ambiance Fluorescent switch knockouts





# Transitions

Ambiance® Transitions is the easy-to-install 120V rail lighting system. A variety of pendant and directional luminaire options are available including mono-point fixtures for stand-alone installation or addition to your rail system. Ambiance® Transitions makes it easy to create the rail-lighting look you want.



## Configure Your System

### STEP 1A

**Choose Pendant Assemblies & Shades**  
Select from complete fixtures or pick your own pendant assembly and shade combination.

*page 68*



### STEP 1B

**Choose Directional Assemblies & Shades**  
Select from complete fixtures or pick your own directional assembly and shade combination.

*page 72*

### STEP 3

**Select Mounting Components**  
Identify desired power feed canopy and necessary support adapters based on length of rail and placement. Rail requires support every 2' to 3' depending on the number of luminaires and bend configuration.

*page 77*

### STEP 2

**Select Rail & Connectors**  
Determine length of rail needed based on number of luminaires and desired spacing per your specifications. Connect sections of rail with the flexible angle or regular connectors.

*page 76*

# Design Guidelines

Ambiance® Transitions is a versatile rail system that offers ease of installation and customization in one package. Choose from complete pendant and directional fixtures, or build your own with multiple luminaire assembly and shade choices. Three light pendant and directional kits are also available in select designs for added convenience.

Directional

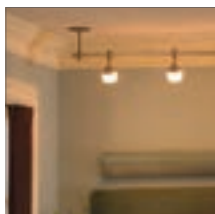

Over Counter

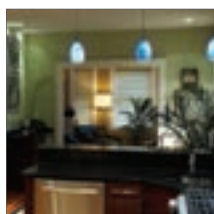

Retail / Commercial

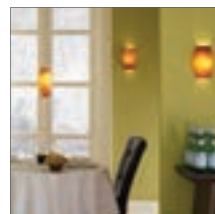

## DIRECTIONAL MONO-POINTS

Complete directional mono-point fixtures including glass, lamp and canopy for wall or ceiling installation.

*page 80*



## RAIL KITS

Complete pendant and directional rail systems. Includes lamps, assemblies, shades, 4ft of rail, power feed canopy adapter, field adjustable wire and all mounting hardware required for typical installation.

*page 82*

# STEP 1A Choose Pendant Fixtures

## Complete Fixtures

### Urban Loft Pendant Fixture

Antique Brushed Nickel Finish with Opal Cased Etched Glass and chrome accent ring. Use on Transitions Rail Systems or as a mono-point. Supplied with 40w 120V T4 G9 halogen lamp, shade, canopy, hanging hardware and 8' of field adjustable wire.

Wattage: 40w max. 120V T4 G9 Halogen Replacement Lamp: 97032-32 or 97037-32 (pages 96-97)



Part Number	Finish	Dimensions
94562-965	Antique Brushed Nickel	D: 4.375" H: 16.312" O: 114.812"

### Saratoga Pendant Fixture

Antique Bronze Finish with Ember Glow Glass. Use on Transitions Rail Systems or as a mono-point. Supplied with 40w 120V T4 G9 halogen lamp, shade, canopy, hanging hardware and 8' of field adjustable wire.

Wattage: 40w max. 120V T4 G9 Halogen Replacement Lamp: 97032-32 or 97037-32 (pages 96-97)



Part Number	Finish	Dimensions
94560-71	Antique Bronze	D: 6.125" H: 19.562" O: 118.125"

### Trenton Pendant Fixture

Antique Bronze Finish with Dusted Ivory Glass. Use on Transitions Rail Systems or as a mono-point. Supplied with 40w 120V T4 G9 halogen lamp, shade, canopy, hanging hardware and 8' of field adjustable wire.

Wattage: 40w max. 120V T4 G9 Halogen Replacement Lamp: 97032-32 or 97037-32 (pages 96-97)



Part Number	Finish	Dimensions
94561-71	Antique Bronze	D: 5.187" H: 14.646" O: 114.386"

### Torry Pendant Fixture

Antique Brushed Nickel Finish with Satin Etched Glass. Use on Transitions Rail Systems or as a mono-point. Supplied with 40w 120V T4 G9 halogen lamp, shade, canopy, hanging hardware and 8' of field adjustable wire.

Wattage: 40w max. 120V T4 G9 Halogen Replacement Lamp: 97032-32 or 97037-32 (pages 96-97)



Part Number	Finish	Dimensions
94563-965	Antique Brushed Nickel	D: 5.281" H: 15.312" O: 114.187"

**NOTE:** If you select one of these complete pendant fixtures you can proceed to page 76 to select rail and connectors.

# STEP 1A Choose Pendant Fixtures

## Build Your Own Fixtures

### Medium Base Pendant Assembly

Supplied with optional canopy, hanging hardware and 8' of field adjustable wire. Choose any appropriate A-type lamp, including our A19 LED lamps located on page 96 (sold separately).

Wattage: M 100w max.



Part Number	Finish	Dimensions
94554-71	Antique Bronze	D: 1.125" H: 12.625" O: 133.375"
94554-965	Antique Brushed Nickel	D: 1.125" H: 12.625" O: 133.375"
94555-71	Antique Bronze	D: 1.063" H: 12.625" O: 133.375"
94555-965	Antique Brushed Nickel	D: 1.063" H: 12.625" O: 133.375"

### G9 Base Pendant Assembly

Supplied with 40w 120V T4 G9 halogen lamp, optional canopy, hanging hardware and 8' of field adjustable wire.

Wattage: 40w max. 120V T4 G9 Halogen

Replacement Lamp: 97032-32 or 97037-32 (pages 96-97)



Part Number	Finish	Dimensions
94570-71	Antique Bronze	D: 1" H: 12.156" O: 112.625"
94570-965	Antique Brushed Nickel	D: 1" H: 12.156" O: 112.625"
94571-71	Antique Bronze	D: 1" H: 12.156" O: 112.437"
94571-965	Antique Brushed Nickel	D: 1" H: 12.156" O: 112.437"

### GU10 Base Pendant Assembly

Supplied with optional canopy, hanging hardware and 8' of field adjustable wire. Select from the 120V MR/MRC16 GU10 lamps on pages 96-97 (sold separately).

Wattage: 50w max. 120V MR/MRC16 GU10



Part Number	Finish	Dimensions
94553-71	Antique Bronze	D: 1.125" H: 11.75" O: 109.375"
94553-965	Antique Brushed Nickel	D: 1.125" H: 11.75" O: 109.375"
94552-71	Antique Bronze	D: 1.063" H: 11.75" O: 109.375"
94552-965	Antique Brushed Nickel	D: 1.063" H: 11.75" O: 109.375"

### GU24 Base Pendant Assembly

Supplied with 13w GU24 self-ballasted lamp (120V NPF), optional canopy, hanging hardware and 8' of field adjustable wire.

Wattage: 13w max. 120V GU24 Self Ballasted Lamp (NPF)

Replacement Lamp: 97102 (pages 96-97)



Part Number	Finish	Dimensions
94620-71	Antique Bronze	D: 1" H: 12.125" O: 111.125"
94620-965	Antique Brushed Nickel	D: 1" H: 12.125" O: 111.125"
94621-71	Antique Bronze	D: 1" H: 12.125" O: 111.125"
94621-965	Antique Brushed Nickel	D: 1" H: 12.125" O: 111.125"

**NOTE:** Choose your pendant shades next on pages 70-71.

## STEP 1A Choose Pendant Shades



94381-6133



94377-6125



94377-6131



94374-6137



94375-6135



94372-6125



94373-6123



94373-6124

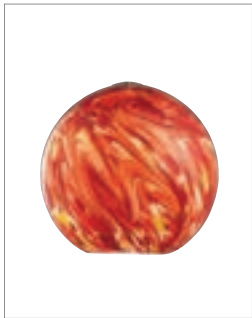

94230-6032

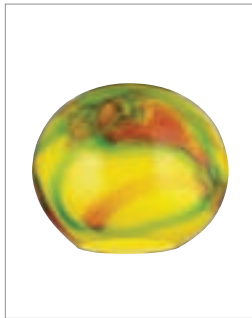

94290-6066



94353-645



94353-648

Part Number	Name	Material	Dimensions	Compatible Assemblies
94381-6133	Cosima	Opal Blown White Glass with Clear Edge	D: 6" H: 6"	GU10 and G9
94377-6125	Andorra	Cased Opal Ribbed Glass	D: 4.625" H: 4.625"	GU10 and G9
94377-6131	Andorra	Cased Amber Ribbed Glass	D: 4.625" H: 4.625"	GU10 and G9
94374-6137	Fossil	Cased Amber Glass with Fossil Pattern	D: 4.5" H: 7.75"	All
94375-6135	Bianca	Cased White and Amber Glass with Engraved Pattern	D: 5.375" H: 8.375"	All
94372-6125	Conner	Cased Opal Ribbed Glass	D: 2.75" H: 7.625"	GU10 and G9
94373-6123	Glacier Blue	Glacier Blue Crackle Glass	D: 2.75" H: 7.5"	GU10 and G9
94373-6124	Bamboo Green	Bamboo Green Crackle Glass	D: 2.75" H: 7.5"	GU10 and G9
94230-6032	Fireball	Cased Fireball Glass	D: 7.687" H: 7.375"	All
94290-6066	Mystique	Blown Mystique Glass	D: 8.25" H: 6.75"	All
94353-645	White Rhapsody	Cased White Rhapsody Glass	D: 4.5" H: 10.5"	All
94353-648	Blue Rhapsody	Blue Swirl Glass	D: 4.5" H: 10.5"	All



## STEP 1A Choose Pendant Shades



94371-6121



94370-607

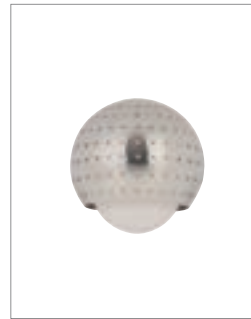

94380-841



94380-962



94228-6026



94229-6029



94229-6030



94229-6028



94223-699



94227-6011



94233-6035



94235-6037

Part Number	Name	Material	Dimensions	Compatible Assemblies
94371-6121	Honey Drop	Honey Cased Glass	D: 6.187" H: 6.562"	All
94370-607	Bristol	Cased Opal Etched Glass	D: 7" H: 3.844"	GU10 and G9
94380-841	Space Ball	Polished Nickel Shade over Cased Opal Etched Glass	D: 4.562" H: 5.813"	GU10 and G9
94380-962	Space Ball	Brushed Nickel Shade over Cased Opal Etched Glass	D: 4.562" H: 5.813"	GU10 and G9
94228-6026	Opal Rain	Opal Rain Glass	D: 6.3125" H: 11"	All
94229-6029	Vanilla Crème	Vanilla Crème Glass	D: 4.5" H: 9.687"	All
94229-6030	Fuego	Fuego Glass	D: 4.5" H: 9.687"	All
94229-6028	Caramel Swirl	Caramel Swirl Glass	D: 4.5" H: 9.687"	All
94223-699	Amber Onyx	Amber Onyx Stone	D: 5.687" H: 5.812"	All
94227-6011	Molten Red	Red/Black Gravel Glass	D: 6.25" H: 9.375"	All
94233-6035	Stargazer	Cased Starlight Blue Glass	D: 5.187" H: 7.875"	All
94235-6037	Butterscotch	Butterscotch Glass	D: 4.312" H: 9.812"	GU10, G9 and GU24

**NOTE:** After selecting pendant assemblies and shades, proceed to page 76 to select rail and connectors.

# STEP 1B Choose Directional Fixtures

## Complete Fixtures

### Urban Loft Directional Fixture

Antique Brushed Nickel Finish with Opal Cased Etched Glass and chrome accent ring. Mount on Transitions 120V Rail Systems. 40w 120V T4 G9 halogen lamp and shade included.



Wattage: 40w max. 120V T4 G9 Halogen  
Replacement Lamp: 97032-32 or 97037-32 (pages 96-97)

Part Number	Finish	Dimensions
94537-965	Antique Brushed Nickel	D: 3.468" L: 3.937" H: 4.593"

### Saratoga Directional Fixture

Antique Bronze Finish with Ember Glow Glass. Mount on Transitions 120V Rail Systems. 40w 120V T4 G9 halogen lamp and shade included.



Wattage: 40w max. 120V T4 G9 Halogen  
Replacement Lamp: 97032-32 or 97037-32 (pages 96-97)

Part Number	Finish	Dimensions
94535-71	Antique Bronze	D: 3.75" L: 6.062" H: 5.75"

### Trenton Directional Fixture

Antique Bronze Finish with Dusted Ivory Glass. Mount on Transitions 120V Rail Systems. 40w 120V T4 G9 halogen lamp and shade included.



Wattage: 40w max. 120V T4 G9 Halogen  
Replacement Lamp: 97032-32 or 97037-32 (pages 96-97)

Part Number	Finish	Dimensions
94536-71	Antique Bronze	D: 3.425" L: 4" H: 6.531"

### Torry Directional Fixture

Antique Brushed Nickel Finish with Satin Etched Glass. Mounts on Transitions 120V Rail Systems. 40w 120V T4 G9 halogen lamp and shade included.



Wattage: 40w max. 120V T4 G9 Halogen  
Replacement Lamp: 97032-32 or 97037-32 (pages 96-97)

Part Number	Finish	Dimensions
94538-965	Antique Brushed Nickel	D: 3.071" L: 4.035" H: 4.962"

### Contemporary Directional Fixture

Antique Bronze or Antique Brushed Nickel Finish. Mounts on Transitions 120V Rail Systems. Includes shade. Uses 120V MR/MRC16 GU10 lamps on pages 96-97 (sold separately).



Wattage: 50w max. 120V MR/MRC16 GU10 Halogen or LED

Part Number	Finish	Dimensions
94895-71	Antique Bronze	D: 3.187" L: 4.437" H: 4.562"
94895-965	Antique Brushed Nickel	D: 3.187" L: 4.437" H: 4.562"

### Traditional Directional Fixture

Antique Bronze or Antique Brushed Nickel Finish. Mounts on Transitions 120V Rail Systems. Includes shade. Uses 120V MR/MRC16 GU10 lamps on pages 96-97 (sold separately).



Wattage: 50w max. 120V MR/MRC16 GU10 Halogen or LED

Part Number	Finish	Dimensions
94896-71	Antique Bronze	D: 3.375" L: 4.75" H: 5.062"
94896-965	Antique Brushed Nickel	D: 3.375" L: 4.75" H: 5.062"

### Transitional Directional Fixture

Antique Bronze or Antique Brushed Nickel Finish. Mounts on Transitions 120V Rail Systems. Includes shade. Uses standard 120V PAR20 lamp (sold separately). Easily converts to LED using 120V PAR20 LED lamps on pages 96-97.



Wattage: 50w max. 120V PAR20 Halogen or LED

Part Number	Finish	Dimensions
94729-71	Antique Bronze	D: 3.25" L: 5.25" H: 4.5"
94729-965	Antique Brushed Nickel	D: 3.25" L: 5.25" H: 4.5"

### Transitional Directional Fixture

Antique Bronze or Antique Brushed Nickel Finish. Mounts on Transitions 120V Rail Systems. Includes shade. Uses standard 120V PAR20 lamp (sold separately). Easily converts to LED using 120V PAR20 LED lamps on pages 96-97.



Wattage: 50w max. 120V PAR20 Halogen or LED

Part Number	Finish	Dimensions
94730-71	Antique Bronze	D: 3.437" L: 5.375" H: 4.875"
94730-965	Antique Brushed Nickel	D: 3.437" L: 5.375" H: 4.875"

### Transitional Directional Fixture

Antique Bronze or Antique Brushed Nickel Finish. Mounts on Transitions 120V Rail Systems. Includes shade. Uses standard 120V PAR30 lamp (sold separately). Easily converts to LED using 120V PAR30 LED lamps on pages 96-97.



Wattage: 75w max. 120V PAR30 Halogen or LED

Part Number	Finish	Dimensions
94731-71	Antique Bronze	L: 6.187" H: 6.719" O: 6.25"
94731-965	Antique Brushed Nickel	L: 6.187" H: 6.719" O: 6.25"

**NOTE:** If you select one of these complete directional fixtures you can proceed to page 76 to select rail and connectors.

# STEP 1B Choose Directional Fixtures

## Build Your Own Fixture

### Rail Mount Transitional Directional Assembly

Antique Bronze or Antique Brushed Nickel Finish. Mounts on Transitions 120V Rail Systems. 50w 120V MR/MRC16 GU10 halogen lamp included. Converts easily to LED with MR16 GU10 LED lamps on pages 96-97 (sold separately).



Wattage: 50w max. 120V MR/MRC16 GU10 Halogen  
Replacement Lamps: MR/MRC16 GU10 LED or Halogen (pages 96-97).

Part Number	Finish	Dimensions
94720-71	Antique Bronze	D: 2" L: 4" H: 4.5" O: 6"
94720-965	Antique Brushed Nickel	D: 2" L: 4" H: 4.5" O: 6"

### Rail Mount Contemporary Directional Assembly

Antique Bronze or Antique Brushed Nickel Finish. Mounts on Transitions 120V Rail Systems. 40w 120V T4 G9 halogen lamp included.



Wattage: 40w max. 120V T4 G9 Halogen  
Replacement Lamp: 97032-32, 97037-32 (pages 96-97)

Part Number	Finish	Dimensions
94726-71	Antique Bronze	D: 1.812" L: 3.687"
94726-965	Antique Brushed Nickel	H: 4.312" O: 5.812"

### Rail Mount Traditional Directional Assembly

Antique Bronze or Antique Brushed Nickel Finish. Mounts on Transitions 120V Rail Systems. 40w 120V T4 G9 halogen lamp included.



Wattage: 40w max. 120V T4 G9 Halogen  
Replacement Lamp: 97032-32, 97037-32 (pages 96-97)

Part Number	Finish	Dimensions
94727-71	Antique Bronze	D: 2" L: 4" H: 4.5" O: 6"
94727-965	Antique Brushed Nickel	D: 2" L: 4" H: 4.5" O: 6"

**NOTE:** Choose your directional shades next on pages 74-75.

## STEP 1B Choose Directional Shades



94386-6133



94391-6125



94391-6131

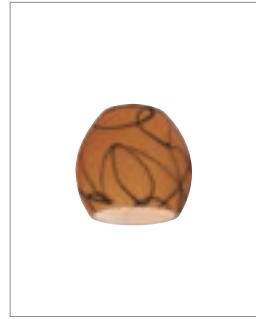

94398-6137



94392-6135



94393-6125



94395-6123



94395-6124

Part Number	Name	Material	Dimensions	Compatible Assemblies
94386-6133	Cosima	Opal Blown White Glass with Clear Edge	D: 4.437" H: 2.812"	All
94391-6125	Andorra	Cased Opal Ribbed Glass	D: 3.656" H: 2.812"	All
94391-6131	Andorra	Cased Amber Ribbed Glass	D: 3.656" H: 2.812"	All
94398-6137	Fossil	Cased Amber Glass with Fossil Pattern	D: 3.125" H: 3.625"	All
94392-6135	Bianca	Cased White and Amber Glass with Engraved Pattern	D: 3.625" H: 2.968"	All
94393-6125	Conner	Cased Opal Ribbed Glass	D: 2.937" H: 3.031"	All
94395-6123	Glacier Blue	Glacier Blue Crackle Glass	D: 3" H: 3.031"	All
94395-6124	Bamboo Green	Bamboo Green Crackle Glass	D: 3" H: 3.031"	All

## STEP 1B Choose Directional Shades



94385-6121



94387-607

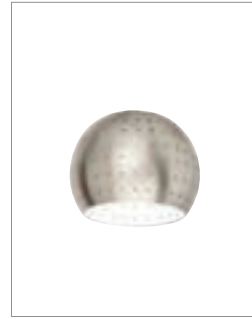

94388-962

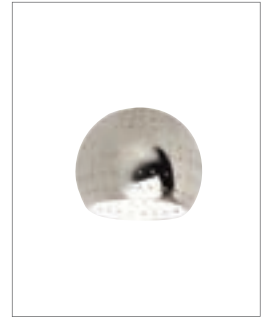

94388-841



94364-71



94364-98



94363-645



94363-649

Part Number	Name	Material	Dimensions	Compatible Assemblies
94385-6121	Honey Drop	Honey Cased Glass	D: 3.437" H: 3"	All
94387-607	Bristol	Cased Opal Etched Glass	D: 3.28" H: 2.937"	All
94388-962	Space Ball	Brushed Nickel Finish	D: 2.419" H: 2.419"	All
94388-841	Space Ball	Polished Nickel Finish	D: 2.419" H: 2.419"	All
94364-71	Metal Dome Shade	Antique Bronze Finish	D: 3.062" H: 2.59"	94726 and 94727
94364-98	Metal Dome Shade	Brushed Stainless Finish	D: 3.062" H: 2.59"	94726 and 94727
94363-645	Glass Dome Shade	Cased Opal Etched Glass	D: 3.062" H: 2.625"	94726 and 94727
94363-649	Glass Dome Shade	Amber Rhapsody Glass	D: 3.062" H: 2.625"	94726 and 94727

**NOTE:** After selecting directional assemblies and shades, proceed to page 76 to select rail and connectors.

## STEP 2 Select Rail & Connectors

### 4' Single Circuit Rail

Field cuttable and bendable rail accommodates 20 amps at 120V. Rail is bendable by hand or with bending tool. Two 12 AWG conductors in thermoplastic insulators. Complete with two end caps. Select optional power feeds, support adapters or joiners. Minimum bending radius is 12".



Part Number	Finish	Dimensions
94840-71	Antique Bronze	L: 4' W: .312" H: .875"
94840-965	Antique Brushed Nickel	L: 4' W: .312" H: .875"

### 8' Single Circuit Rail

Field cuttable and bendable rail accommodates 20 amps at 120V. Rail is bendable by hand or with bending tool. Two 12 AWG conductors in thermoplastic insulators. Complete with two end caps. Select optional power feeds, support adapters or joiners. Minimum bending radius is 12".



Part Number	Finish	Dimensions
94841-71	Antique Bronze	L: 8' W: .312" H: .875"
94841-965	Antique Brushed Nickel	L: 8' W: .312" H: .875"

### Rail Connector

Electrically or mechanically connects two sections of rail. Remove contacts for mechanical, non-conductive joiner. 20 amp max. at 120V. Rail slides tightly into connector. Phillips head grounding set screw holds rail in place. No disassembly of connector required.



Part Number	Finish	Dimensions
94842-71	Antique Bronze	L: 1.375" W: 1.625" H: 1.062"
94842-965	Antique Brushed Nickel	L: 1.375" W: 1.625" H: 1.062"

### Rail Flexible Angle Connector

Flexible, conductive joiner. Electrically connect two sections of rail. Rotates 100 degrees both directions. 20 amp max. at 120V. Rail slides tightly into connector. Phillips head grounding set screw holds rail in place. No disassembly of connector required.



Part Number	Finish	Dimensions
94847-71	Antique Bronze	L: 4.375" W: 1.062" H: 1"
94847-965	Antique Brushed Nickel	L: 4.375" W: 1.062" H: 1"

### Rail Field Bending Kit

For field bending 94840 and 94841 rails. Adjust roller to bend rail to desired radius. Use multiple "pass throughs" to achieve smooth bend. Minimum bending radius is 12".



Part Number	Finish	Dimensions
94130-12	Black	L: 7.75" W: 6" H: 9.75"

# STEP 3 Select Mounting Components

## Power Feed Canopy Adapter

Ceiling mount and attach at any point along the rail. Mounts to a standard 4" junction box. Single circuit with 6' long 12 AWG supply wires. Use with stem extensions if desired. 20 amps at 120V.



Traditional Style: 94843 Contemporary Style: 94844

Part Number	Finish	Dimensions
94843-71	Antique Bronze	D: 5.125" W: 5.697" O: 7.187"
94843-965	Antique Brushed Nickel	D: 5.125" W: 5.697" O: 7.187"
94844-71	Antique Bronze	D: 5" H: 5.875" O: 7.375"
94844-965	Antique Brushed Nickel	D: 5" H: 5.875" O: 7.375"

## Flexible Power Feed Canopy Adapter

Single circuit 10', 12 AWG supply wires. Use for feeding from remote standard 4" junction box. Field cuttable 10' wire and flexible cover. 20 amps at 120V.



Traditional Style: 94856 Contemporary Style: 94857

Part Number	Finish	Dimensions
94856-71	Antique Bronze	D: 5.125" O: 124.312"
94856-965	Antique Brushed Nickel	D: 5.125" O: 124.312"
94857-71	Antique Bronze	D: 5" O: 123.375"
94857-965	Antique Brushed Nickel	D: 5" O: 123.375"

## Swivel Power Feed Canopy Adapter

Cathedral ceiling mount, attach at any point along rail. Mounts to standard 4" junction box. Single circuit with 6' long 12 AWG supply wires. Use with stem extensions if desired. Supports vertical to 90 degrees. 20 amps at 120V.



Traditional Style: 94854 Contemporary Style: 94855

Part Number	Finish	Dimensions
94854-71	Antique Bronze	D: 5.125" H: 9.562" O: 11"
94854-965	Antique Brushed Nickel	D: 5.125" H: 9.562" O: 11"
94855-71	Antique Bronze	D: 5.125" H: 9.562" O: 11"
94855-965	Antique Brushed Nickel	D: 5.125" H: 9.562" O: 11"

## Support Adapter

Non-electrified adapter attaches at any point along the rail. Use with stem extensions if desired. Complete with mounting hardware. Use with optional power feeds when rail is ceiling mounted. Support rail every 2' to 3' depending on the quantity of fixtures and the bend configuration of the rail.

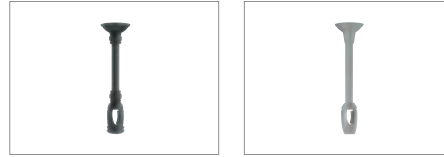

Traditional Style: 94850 Contemporary Style: 94851

Part Number	Finish	Dimensions
94850-71	Antique Bronze	D: 1.812" W: 5.687" O: 7.187"
94850-965	Antique Brushed Nickel	D: 1.812" W: 5.687" O: 7.187"
94851-71	Antique Bronze	D: 1.812" H: 5.875" O: 7.375"
94851-965	Antique Brushed Nickel	D: 1.812" H: 5.875" O: 7.375"

## Cable Support Adapter

10' field adjustable air-craft cable. Use where non-visible floating rail support look is desired. Complete with mounting hardware and non-electrified adapter. Support rails every 2' to 3' depending on the quantity of fixtures and the bend configuration of the rail.



Traditional Style: 94846 Contemporary Style: 94845

Part Number	Finish	Dimensions
94846-71	Antique Bronze	D: 1.812" W: 1.312" O: 120"
94846-965	Antique Brushed Nickel	D: 1.812" W: 1.312" O: 120"
94845-71	Antique Bronze	D: 1.812" H: 1.312" O: 120"
94845-965	Antique Brushed Nickel	D: 1.812" H: 1.312" O: 120"

## Swivel Support Adapter

Mechanically supports rail on cathedral ceilings. Use interconnecting stems if desired. Supports vertical to 90 degrees. Complete with mounting hardware and non-electrified adapter.



Traditional Style: 94860 Contemporary Style: 94861

Part Number	Finish	Dimensions
94860-71	Antique Bronze	D: 5.125" H: 9.562" O: 11"
94860-965	Antique Brushed Nickel	D: 5.125" H: 9.562" O: 11"
94861-71	Antique Bronze	D: 5.125" H: 9.562" O: 11"
94861-965	Antique Brushed Nickel	D: 5.125" H: 9.562" O: 11"

# STEP 3 Select Mounting Components

## Wall Power Feed / Support

Electrically feeds and supports rail from wall. Single circuit 30" long 12 AWG supply wires. Use with interconnecting stem extensions if desired (max. distance from wall is 30"). Field adjustable aircraft cable support. Complete with canopy and mounting hardware. Mounts to standard junction box. 20 amps at 120V.



Traditional Style: 94848

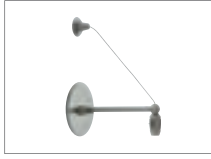

Contemporary Style: 94849

Part Number	Finish	Dimensions
94848-71	Antique Bronze	W: 5.125" Ext: 8" to 30"
94848-965	Antique Brushed Nickel	W: 5.125" Ext: 8" to 30"
94849-71	Antique Bronze	W: 5" Ext: 8" to 30"
94849-965	Antique Brushed Nickel	W: 5" Ext: 8" to 30"

## Flexible Wall Power Feed Canopy

Electrically feeds from end of the rail. Complete with canopy and mounting hardware. Mounts to a standard 4" junction box. Rotates 50 degrees both directions. 20 amps at 120V. Rail slides tightly into connector. Phillips head grounding set screw holds rail in place. No disassembly required.



Traditional Style: 94852



Contemporary Style: 94853

Part Number	Finish	Dimensions
94852-71	Antique Bronze	D: 5" Ext: 2.875"
94852-965	Antique Brushed Nickel	D: 5" Ext: 2.875"
94853-71	Antique Bronze	D: 5.125" Ext: 3.5"
94853-965	Antique Brushed Nickel	D: 5.125" Ext: 3.5"

## Support Connector

Electrically feeds, supports and connects two sections of rail (or) remove contacts for mechanical, non-conductive joiner. Use with interconnecting stem extensions if desired. 20 amps at 120V.



Traditional Style: 94862



Contemporary Style: 94863

Part Number	Finish	Dimensions
94862-71	Antique Bronze	W: 4.625" H: 5.687" O: 7.25"
94862-965	Antique Brushed Nickel	W: 4.625" H: 5.687" O: 7.25"
94863-71	Antique Bronze	W: 4.625" H: 5.687" O: 7.31"
94863-965	Antique Brushed Nickel	W: 4.625" H: 5.687" O: 7.31"

## Wall Support

Mechanically supports rail from wall. Use with interconnecting stems if desired (max. distance from wall is 30"). Field adjustable aircraft cable support. Complete with all mounting hardware and non-electrified adapter. Use with optional power feeds when wall mounting is desired.



Traditional Style: 94858

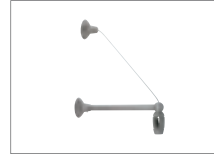

Contemporary Style: 94859

Part Number	Finish	Dimensions
94858-71	Antique Bronze	D: 5.125" H: 9.562" O: 11"
94858-965	Antique Brushed Nickel	D: 5.125" H: 9.562" O: 11"
94859-71	Antique Bronze	D: 5.125" H: 9.562" O: 11"
94859-965	Antique Brushed Nickel	D: 5.125" H: 9.562" O: 11"

## 6" Stem Extension

Use in conjunction with rail feed and support adapters. Stems interconnect with internal threads.



Part Number	Finish	Dimensions
94806-71	Antique Bronze	L: 6" D: .5"
94806-965	Antique Brushed Nickel	L: 6" D: .5"

## 12" Stem Extension

Use in conjunction with rail feed and support adapters. Stems interconnect with internal threads.



Part Number	Finish	Dimensions
94807-71	Antique Bronze	L: 12" D: .5"
94807-965	Antique Brushed Nickel	L: 12" D: .5"





Transitions

# Complete Directional Mono-Point Fixtures

## Saratoga Directional Mono-Point

Antique Bronze Finish with Ember Glow Glass. Mounts on wall or ceiling. Includes 40w 120V T4 G9 halogen lamp and shade.

Wattage: 40w max. 120V T4 G9 Halogen  
Replacement Lamp: 97032-32 or 97037-32 (pages 96-97)



Part Number	Finish	Dimensions
94882-71	Antique Bronze	D: 3.75" L: 6.062" H: 5.5"

## Trenton Directional Mono-Point

Antique Bronze Finish with Dusted Ivory Glass. Mounts on wall or ceiling. Includes 40w 120V T4 G9 halogen lamp and shade.

Wattage: 40w max. 120V T4 G9 halogen  
Replacement Lamp: 97032-32 or 97037-32 (pages 96-97)



Part Number	Finish	Dimensions
94883-71	Antique Bronze	D: 3.425" L: 5.709" H: 6.614"

## Traditional Directional Mono-Point

Antique Bronze or Antique Brushed Nickel Finish. Mounts on wall or ceiling. Includes shade. Select from 120V MR/MRC16 GU10 lamps on pages 96-97.

Wattage: 50w max. 120V MR/MRC16 GU10  
Halogen or LED



Part Number	Finish	Dimensions
94898-71	Antique Bronze	D: 3.375" L: 6.5" H: 5"
94898-965	Antique Brushed Nickel	D: 3.375" L: 6.5" H: 5"

## Contemporary Directional Mono-Point

Antique Bronze or Antique Brushed Nickel Finish. Mounts on wall or ceiling. Includes shade. Select from 120V MR/MRC16 GU10 lamps on pages 96-97.

Wattage: 50w max. 120V MR/MRC16 GU10  
Halogen or LED



Part Number	Finish	Dimensions
94897-71	Antique Bronze	D: 3.1875" L: 6.25" H: 4.25"
94897-965	Antique Brushed Nickel	D: 3.1875" L: 6.25" H: 4.25"



# RAIL KITS

## Complete Three Light Pendant Rail Kits

### Urban Loft Pendant Kit

Includes three pendants in Antique Brushed Nickel Finish with Opal Cased Etched Glass, Chrome Accent Ring, (3) 40w 120V T4 G9 halogen lamps and shades, 4ft. extruded aluminum rail with 12 gauge connectors and two ends, power feed canopy adapter, mounting hardware and 8ft. of adjustable wire.

Wattage: (3) 40w max. 120V T4 G9 Halogen  
Replacement Lamp: 97032-32 or 97037-32 (pages 96-97)

Part Number	Finish	Dimensions
94516-965	Antique Brushed Nickel Cased Opal Etched Glass	L: 47.625"



### Saratoga Pendant Kit

Includes three pendants in Antique Bronze Finish with Ember Glow Glass, (3) 40w 120V T4 G9 halogen lamps and shades, 4ft. extruded aluminum rail with 12 gauge conductors and two ends, power feed canopy adapter, mounting hardware and 8 ft. of adjustable wire.

Wattage: (3) 40w max. 120V T4 G9 Halogen  
Replacement Lamp: 97032-32 or 97037-32 (pages 96-97)

Part Number	Finish	Dimensions
94512-71	Antique Bronze Ember Glow Glass	L: 47.625"



### Trenton Pendant Kit

Includes three pendants in Antique Bronze Finish with Dusted Ivory Glass, (3) 40w 120V T4 G9 halogen lamps and shades, 4 ft. extruded aluminum rail with 12 gauge conductors and two ends, power feed canopy adapter, mounting hardware and 8 ft. of adjustable wire.

Wattage: (3) 40w max. 120V T4 G9 Halogen  
Replacement Lamp: 97032-32 or 97037-32 (pages 96-97)

Part Number	Finish	Dimensions
94514-71	Antique Bronze Dusted Ivory Glass	L: 47.625"



### Torry Pendant Kit

Includes three pendants in Antique Brushed Nickel Finish with Satin Etched Glass, (3) 40w 120V T4 G9 halogen lamps and shades, 4 ft. extruded aluminum rail with 12 gauge conductors and two ends, power feed canopy adapter, mounting hardware and 8 ft. of adjustable wire.

Wattage: (3) 40w max. 120V T4 G9 Halogen  
Replacement Lamp: 97032-32 or 97037-32 (pages 96-97)

Part Number	Finish	Dimensions
94518-965	Antique Brushed Nickel Satin Etched Glass	L: 47.625"



## Complete Three Light Directional Rail Kits

### Urban Loft Directional Kit

Includes three directional fixtures in Antique Brushed Nickel Finish with Opal Cased Etched Glass, Chrome Accent Ring, (3) 40w 120V T4 G9 halogen lamps and shades, 4ft. extruded aluminum rail with 12 gauge connectors and two ends, power feed canopy adapter, mounting hardware and 8ft. of adjustable wire.

**Wattage:** (3) 40w max. 120V T4 G9 Halogen  
**Replacement Lamp:** 97032-32 or 97037-32 (pages 96-97)

Part Number	Finish	Dimensions
94515-965	Antique Brushed Nickel Cased Opal Etched Glass	L: 47.625"

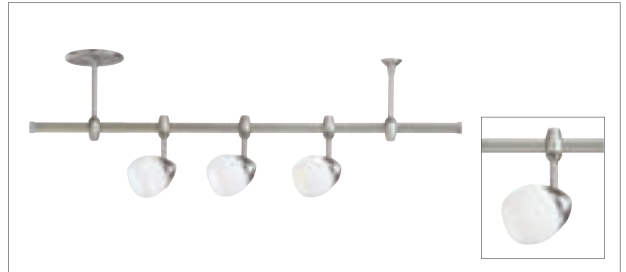

### Saratoga Directional Kit

Includes three directional fixtures in Antique Bronze Finish with Ember Glow Glass, (3) 40w 120V T4 G9 halogen lamps and shades, 4ft. extruded aluminum rail with 12 gauge conductors and two ends, power feed canopy adapter, mounting hardware and 8 ft. of adjustable wire.

**Wattage:** (3) 40w max. 120V T4 G9 Halogen  
**Replacement Lamp:** 97032-32 or 97037-32 (pages 96-97)

Part Number	Finish	Dimensions
94511-71	Antique Bronze Ember Glow Glass	L: 47.625"



### Trenton Directional Kit

Includes three directional fixtures in Antique Bronze Finish with Dusted Ivory Glass, (3) 40w 120V T4 G9 halogen lamps and shades, 4 ft. extruded aluminum rail with 12 gauge conductors and two ends, power feed canopy adapter, mounting hardware and 8 ft. of adjustable wire.

**Wattage:** (3) 40w max. 120V T4 G9 Halogen  
**Replacement Lamp:** 97032-32 or 97037-32 (pages 96-97)

Part Number	Finish	Dimensions
94513-71	Antique Bronze Dusted Ivory Glass	L: 47.625"



### Torry Directional Kit

Includes three directional fixtures in Antique Brushed Nickel Finish with Satin Etched Glass, (3) 40w 120V T4 G9 halogen lamps and shades, 4 ft. extruded aluminum rail with 12 gauge conductors and two ends, power feed canopy adapter, mounting hardware and 8 ft. of adjustable wire.

**Wattage:** (3) 40w max. 120V T4 G9 Halogen  
**Replacement Lamp:** 97032-32 or 97037-32 (pages 96-97)

Part Number	Finish	Dimensions
94517-965	Antique Brushed Nickel Satin Etched Glass	L: 47.625"







# Mini-Recessed

Ambiance® low-voltage miniature recessed lighting offers versatility with lamp and beam options that put the right light where you need it. For highlighting objects, drawing attention to architectural details and improving overall illumination indoors or out, miniature recessed lighting adds a designer's touch.



## Configure your System

### STEP 1

#### Choose Housing & Lamps

Choose the recessed housing that best meets your needs, identify the light output required and then order the lamps desired from the choices listed for your housing.

*page 88*



### STEP 2

#### Select Trims

Choose from reflector trim or decorative metal trim ring based on housing selected.

*page 89*



### STEP 3

#### Select Transformers

Multiply the watts consumed per lamp by number of lamps to determine transformer size.

*page 89*





# Design Guidelines

Ambiance® Mini-Recessed lighting offers lamp and beam options that shape and direct light right to your specifications. Utilize crisp directional or soft general lighting to highlight objects and draw attention to architectural details. Ambiance® Mini-Recessed lighting adds another layer to your lighting design that will accentuate the details of your space.

Wall Grazing



Showcase / Shelf

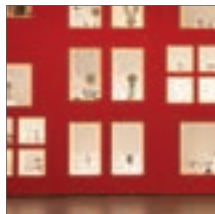

# STEP 1 Choose Housing & Lamps

## Non-IC Housing with Trim

### MRC11 Housing with Eyeball Trim

Wattage: 20w max. MRC11 GU4 Bi-Pin.  
 Select from the following lamps: 9787, 9789, 97004 (sold separately).  
 Die-cast aluminum housing with powdercoat finish. 12 and 24V. Wet location listed (12V only).



Part Number	Finish	Dimensions
9424-12	Black	D: 2.75" H: 3.25"
9424-15	White	D: 2.75" H: 3.25"

### MRC11 Housing with Trim

Wattage: 20w max. MRC11 GU4 Bi-Pin.  
 Select from the following lamps: 9787, 9789, 97004 (sold separately).  
 Die-cast aluminum housing with powdercoat finish. 12 and 24V. Wet location listed (12V only).



Part Number	Finish	Dimensions
9426-12	Black	D: 2.75" H: 3.25"
9426-15	White	D: 2.75" H: 3.25"

## Non-IC Housing without Trim

### T3 Housing

Wattage: 20w max. T3 G4 Bi-Pin.  
 Uses lamp: 9784 (sold separately).  
 Die-cast aluminum housing with powdercoat finish. 12 volt only. Wet location listed.  
 Requires trim 9357.



Part Number	Finish	Dimensions
9412-12	Black	D: 2.75" H: 3.25"
9412-15	White	D: 2.75" H: 3.25"

### T5 Housing

Wattage: 18w max. T5 Wedge Base.  
 Select from the following lamps: 9774, 9775, 9776, 9777, 9778 (sold separately).  
 Die-cast aluminum housing with powdercoat finish. 12 and 24V. Wet location listed (12V only). Can use trim 9357.



Part Number	Finish	Dimensions
9409-12	Black	D: 2.75" H: 3.25"
9409-15	White	D: 2.75" H: 3.25"

## Lamps

Item Number	9787	9789	97004	9784
Lamp Type	MRC11 Halogen	MRC11 Halogen	MRC11 Halogen	T3 Halogen
Color Temperature	3000°K	3000°K	3000°K	2850°K
Voltage	12V AC	12V AC	24V AC	12V AC
Rated Watts	20 watts	20 watts	20 watts	20 watts
Lumens	10	30	30	320
Rated Average Life	2,000 hours	2,000 hours	2,000 hours	2,000 hours
Lamp Base	GU4 Bi-Pin			G4 Bi-Pin
Compatible Housing	9424(-xx) and 9426(-xx)			9412(-xx)



9787, 9789, 97004



9784

Item Number	9774	9775	9776	9777	9778
Lamp Type	T5 Xenon	T5 Xenon	T5 Incandescent	T5 Incandescent	T5 Incandescent
Color Temperature	2800°K	2800°K	2650°K	2750°K	2800°K
Voltage	12V AC	24V AC	12V AC	12V AC	12V AC
Rated Watts	18 watts	18 watts	8 watts	12 watts	18 watts
Lumens	210	210	57	120	210
Rated Average Life	10,000 hours	2,000 hours	2,500 hours	2,000 hours	2,000 hours
Lamp Base	Wedge				
Compatible Housing	9409(-xx)				



9774, 9775, 9776, 9777, 9778

## STEP 2 Select Trims

### Open Trim with Lens

Used in conjunction with 9409 and 9412 housings.



Part Number	Finish	Dimensions
9357-12	Black	D: 2" H: .75"
9357-15	White	D: 2" H: .75"

### Optional Decorative Metal Trim Ring

Used in conjunction with 9409, 9412, 9424 and 9426 housings.



Part Number	Finish	Dimensions
9487-12	Black	D: 3.25" H: .312"
9487-15	White	D: 3.25" H: .312"

## STEP 3 Select Transformers

The Mini-Recessed system is compatible with all the Lx transformers on pages 21-23.

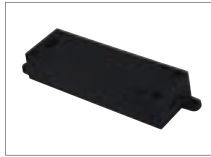

# Technical Information

## Electronic Transformers

Electronic transformers range in size from single output 60 watt (Class II), dual output 60 watt (120 watt total) and single output 150 watt (Class I). Our transformers run quiet, are instant-on, feature fire-rated housings and dim easily with electronic low-voltage (ELV) dimmers. Ambiance Electronic Transformers specify whether they have a minimum load requirement — starting at 15 watts — or whether they are zero-load capable. Zero-load transformers have been designed for the low wattage draws of LED technology. For proper operation of an electronic transformer, the wattage load must fall within the specified range. Ambiance Electronic Transformers are moisture and shock resistant, featuring soft start circuitry for increased lamp life. Electronic transformers, as with many electronic components, may cause radio frequency interference (RFI). Ambiance electronic transformers have built-in filters to help eliminate RFI. Should RFI be noticeable, rotate the unit to change the direction of the electronic field or replace with a magnetic transformer, which will not cause RFI.

## Magnetic Transformers

Ambiance laminated magnetic transformers are core and coil, isolated type transformers. We offer several sizes of laminated magnetic transformers ranging from 150 to 600 watts at 12 Volts, and 250 to 1000 watts at 24 Volts. Multi-tap transformers are available in 300 and 600 watt versions for 12 volt, and 500 and 1000 watt versions for 24 volt systems. Each transformer features thermal protection on the primary (120V) side. Ambiance laminated magnetic transformers have resettable thermal circuit breakers on the low voltage side. Other features include a faraday shield, potted and encased core and coil for added safety and ease of installation. A boost tap is integrated to single-tap magnetic transformers to compensate for voltage drop. Multi-tap transformers have additional voltage choices to compensate for severe voltage drop, as opposed to a single boost tap. For optimum operation we recommend the load on all laminated magnetic transformers be between 50 and 100% of the rated wattage when used with xenon and halogen light sources. Not meeting minimum recommend loads can overdrive luminaires and greatly reduce lamp life. Be sure to keep insulation away from transformers. Magnetic transformers should be mounted vertically. If the transformer must be mounted horizontally, the ambient temperature must be below 120°F and the maximum load should be reduced to 80% of output. Multi-tap transformers may be loaded to 100% when mounted horizontally.

## Operating Temperatures

Ambiance Lighting Systems require adequate ventilation to dissipate heat generated during their operation. Care must be taken to avoid installing the system in confined areas where excessive heat may result in the transformer circuit breaker tripping or causing damage to the system and/or the area being illuminated. Surface temperatures on transformers, wiring and luminaires must not exceed 90°C (194°F).

## Dimming

Ambiance Lighting Systems may be dimmed. When dimming a low-voltage system, it is recommended that the dimming occur on the primary side of the transformer, reducing the power coming into the transformer. The dimmer must be matched to the type of transformer that's powering the system.

- For electronic transformers use an electronic low voltage (ELV) dimmer.
- For magnetic transformers use a standard, incandescent line voltage dimmer or a magnetic low voltage (MLV) dimmer.

## Remote Mounting

When a transformer needs to be mounted in a remote location, a properly sized jumper wire (the cable between the transformer and the start of the lighting run, or between two illuminated sections) must be used. The jumper wire can be Ambiance Cable run in additional protection (9435 track and 9439 cover, 9431 sleeving, or listed conduit), Romex or Type AC. Be sure to check with your local electrical inspector. The jumper wire and lighting run must be connected in an approved wiring compartment, such as 9459 or 9481.

## Powering Transformers

We recommend operating transformers used with Ambiance Lighting Systems on the line voltage (120V or primary) side of the connection for optimum performance and safety. For applications which require operating to be done on the low voltage (secondary) side of the connection, there are two factors which need to be considered:

1. It is very important that the switch used is rated for the amperage created; and
2. Meet minimum load on electronic transformer

To calculate amperage, use the following formula: Amperage = Wattage / Voltage

## Multi-Tap Transformers

In order to ensure voltage consistency and maintain the voltage criterion of lamps, multi-tap magnetic transformers are offered. Multi-tap transformer terminals are 12, 13, 14 and 15V on 12V systems and 24, 26, 28 and 30V on 24V systems.

## Voltage Drop

Voltage drop is the difference between voltage of luminaires close to the transformer and luminaires at the end of an illuminated section.

- All lamp sources function optimally with no more than 10% voltage drop. Voltage outside of this range will affect lamp life and overall performance.
- To compensate for voltage drop, the closest linear run section should be powered by the lowest voltage tap and the furthest linear run should be powered by a higher voltage tap. This is done to ensure consistent voltage and light output, uniform color temperature and longer lamp life.

### How to Calculate Voltage Drop:

Step 1:

$\text{Amps} \times \text{Run/Length} \times 2 \text{ (for AC circuit)} \times \text{Resistance per Foot}^{(1)} = \text{Voltage Drop (in Volts)}$

\*Amps = (Watts/Voltage)

Step 2:

- For 12V systems add voltage drop to 12 to determine tap to use.
- For 24V systems add voltage drop to 24 to determine tap to use.

#### <sup>(1)</sup>Resistance per Foot Chart

Wire Size	Resistance
4	0.000249
6	0.000395
8	0.000640
<b>10*</b>	<b>0.001080</b>
12	0.001620
14	0.002525
16	0.004016
18	0.006385

\*Size of 10/2 AWG Ambiance Cable

# Technical Information

## Fused Plug

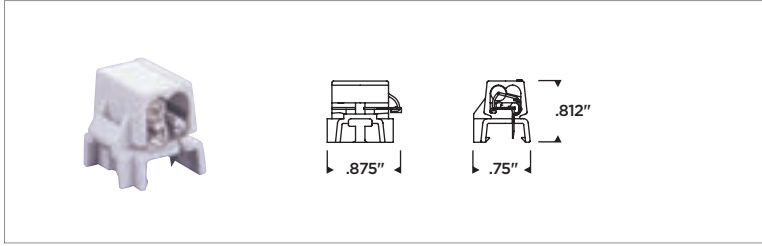

Our 5 amperes Fused Plug turns the Ambiance Lx Cable into a buss system, capable of powering multiple luminaire types. Tap on Ambiance Incandescent/Xenon Disks, LED Disks and LED Tape Lighting to your linear Lx Cable System with ease. No other system matches the versatility and installation options of Ambiance Lighting Systems.

Item Number	9488(-xx)
Voltage	12V and 24V
Max. Wattage	60w at 12V, 120w at 24V
Certification	cETL, damp location
Material / Finish	(-12) Black and (-15) White Polycarbonate with corrosion resistant contacts

- Multiple luminaire types, one transformer
- Add Ambiance LED Disk, Xenon Disk and LED Tape lighting to a new or existing Lx Cable Lighting System
- Snaps onto Ambiance Cable and Track
- Insert 18/2 cord into plug and press in contacts for connection
- 5 AMP limit on each Fused Plug

### Fused Plug with LED Disks (shown below at left)

- Wire LED Disk directly to Fused Plug or use Lx Cable Extension with Wiring Compartment
- Hub connector can also be used to wire multiple disks off of Fused Plug
- Place 9488 Fused Plug onto Lx Cable and Track

### Fused Plug with LED Tape (shown below at right)

- Wire LED Tape directly to 9488 Fused Plug or use Lx Cable extension with 9459 Wiring Compartment\*
- Place Fused Plug onto Lx Cable and Track

\* Using an LED Tape Connection Cable, cut and remove the male end. Strip your 5 leads. Twist together the two leads on the left, twist together the two leads on the right, the center lead is not needed and may be trimmed.

### Fused Plug with Xenon/Incandescent Disks

- Wire Xenon/Incandescent Disk to Fused Plug\*
- Place 9488 Fused Plug onto Lx Cable and Track

\* Limit one disk per fused plug



Fused Plug with LED Disks









Fused Plug with LED Tape







Technical Information

# Lamp Reference Chart

## 12 VOLT

Lamp Image	Item Number	Description	Lamp Type	Lamp Base	Watts Rated
	96116S-32	clear LED festoon 2700K	T3	Festoon	0.708
	96116S-33	frosted LED festoon 2700K	T3	Festoon	0.708
	96118S-32	clear LED festoon 3000K	T3	Festoon	0.633
	96118S-33	frosted LED festoon 3000K	T3	Festoon	0.633
	96119S-32	clear LED festoon 4000K	T3	Festoon	0.661
	96119S-33	frosted LED festoon 4000K	T3	Festoon	0.661
	97118-32	5w clear xenon festoon	T3	Festoon	5
	97118-33	5w frosted xenon festoon	T3	Festoon	5
	97119-32	10w clear xenon festoon	T3	Festoon	10
	97119-33	10w frosted xenon festoon	T3	Festoon	10
	9727	3w clear incandescent wedge	T3 1/4	Wedge	3
	9728	5w clear incandescent wedge	T3 1/4	Wedge	5
	9729	5w clear incandescent wedge	T3 1/4	Wedge	5
	9731	3w clear xenon wedge	T3 1/4	Wedge	3
	9732	5w clear xenon wedge	T3 1/4	Wedge	5
	9774	18w clear xenon wedge	T5	Wedge	18
	9776	8w clear incandescent wedge	T5	Wedge	8
	9777	12w clear incandescent wedge	T5	Wedge	12
	9778	18w clear incandescent wedge	T5	Wedge	18
	9787	20w clear halogen MRC11 bi-pin	MRC11	GU4 Bi-Pin	20
	9789	20w clear MRC11 halogen bi-pin	MRC11	GU4 Bi-Pin	20
	97305S	6w clear LED MR16 3000K	MR16	GU5.3	5.75
	97405S	6w clear LED MR16 2700K	MR16	GU5.3	5.52
	97505S	6w clear LED MR16 4000K	MR16	GU5.3	5.81
	9784	20w clear halogen T3 bi-pin	T3	G4 Bi-Pin	20

## 24 VOLT

Lamp Image	Item Number	Description	Lamp Type	Lamp Base	Watts Rated
	96117S-32	clear LED festoon 2700K	T3	Festoon	0.708
	96117S-33	frosted LED festoon 2700K	T3	Festoon	0.708
	96120S-32	clear LED festoon 3000K	T3	Festoon	0.633
	96120S-33	frosted LED festoon 3000K	T3	Festoon	0.633
	96121S-32	clear LED festoon 4000K	T3	Festoon	0.661
	96121S-33	frosted LED festoon 4000K	T3	Festoon	0.661
	97120-32	5w clear xenon festoon	T3	Festoon	5
	97120-33	5w frosted xenon festoon	T3	Festoon	5
	97121-32	10w clear xenon festoon	T3	Festoon	10
	97121-33	10w frosted xenon festoon	T3	Festoon	10
	97122-33	7w frosted xenon festoon	T3	Festoon	7
	9775	18w clear xenon wedge	T5	Wedge	18
	97004	20w MRC11 halogen	MRC11	GU4 Bi-Pin	20











# Lamp Reference Chart

Watts Consumed	Rated Life (Hours)	Beam Spread	Light Output (Lumens)	CRI	Color Temperature (°K)	ENERGY STAR®
0.708	35,000 to 70%	n/a	29	>90	2700	N
0.708	35,000 to 70%	n/a	29	>90	2700	N
0.633	35,000 to 70%	n/a	25	>90	3000	N
0.633	35,000 to 70%	n/a	25	>90	3000	N
0.661	35,000 to 70%	n/a	26	>85	4000	N
0.661	35,000 to 70%	n/a	26	>85	4000	N
4.2	16,000	n/a	33	>90	2550	N
4.2	16,000	n/a	33	>90	2550	N
8.4	12,000	n/a	83	>90	2650	N
8.4	12,000	n/a	83	>90	2650	N
2.1	20,000	n/a	8	>90	2200	N
4	9,000	n/a	23	>90	2300	N
3.9	2,000	n/a	26	>90	2450	N
2.7	19,000	n/a	15	>90	2400	N
4.2	8,000	n/a	33	>90	2550	N
16.2	10,000	n/a	210	>90	2800	N
8	2,500	n/a	57	>90	2650	N
11.6	2,000	n/a	120	>90	2750	N
16.2	2,000	n/a	210	>90	2800	N
20	2,000	n/a	10	>90	3000	N
20	2,000	n/a	30	>90	3000	N
5.75	35,000 to 70%	FL 40°	258	>88.6	3000	Y
5.52	35,000 to 70%	FL 40°	246	>88.2	2700	Y
5.81	35,000 to 70%	FL 40°	282	>89.4	4000	Y
20	2,000	n/a	320	>90	2850	N

Watts Consumed	Rated Life (Hours)	Beam Spread	Light Output (Lumens)	CRI	Color Temperature (°K)	ENERGY STAR®
0.708	35,000 to 70%	n/a	29	>90	2700	N
0.708	35,000 to 70%	n/a	29	>90	2700	N
0.633	35,000 to 70%	n/a	25	>90	3000	N
0.633	35,000 to 70%	n/a	25	>90	3000	N
0.661	35,000 to 70%	n/a	26	>85	4000	N
0.661	35,000 to 70%	n/a	26	>85	4000	N
4.2	16,000	n/a	33	>90	2550	N
4.2	16,000	n/a	33	>90	2550	N
8.4	12,000	n/a	83	>90	2650	N
8.4	12,000	n/a	83	>90	2650	N
6.7	95,000	n/a	46	>90	2420	N
16.2	2,000	n/a	210	>90	2800	N
20	2,000	NFL 30°	30	>90	3000	N

# Lamp Reference Chart

## 120 VOLT

Lamp Image	Item Number	Description	Lamp Type	Lamp Base	Watts Rated
	97102	13w GU24 Compact Fluorescent	Self Ballasted CFL	GU24	13
	97170	20w clear halogen MRC16 24 Degree Beam	MRC16	GU10	20
	97171	20w clear halogen MRC16 38 Degree Beam	MRC16	GU10	20
	97175	35w clear halogen MRC16 24 Degree Beam	MRC16	GU10	35
	97176	35w clear halogen MRC16 38 Degree Beam	MRC16	GU10	35
	97180	50w clear halogen MRC16 24 Degree Beam	MRC16	GU10	50
	97181	50w clear halogen MRC16 38 Degree Beam	MRC16	GU10	50
	97185	20w frosted MRC16 halogen	MRC16	GU10	20
	97186	35w frosted MRC16 halogen	MRC16	GU10	35
	97187	50w frosted MRC16 halogen	MRC16	GU10	50
	97032-32	35w clear halogen T4	T4	G9	35
	97037-32	40w clear halogen T4	T4	G9	40
	97190-32	35w clear xenon T4	T4	G9	35
	97304S	6w LED MR16 GU10 3000K	MR16	GU10	6
	97404S	6w LED MR16 GU10 2700K	MR16	GU10	6
	97504S	6w LED MR16 GU10 4000K	MR16	GU10	6
	97308S	8w LED A19 3000K	A19	E26 Med	8
	97408S	8w LED A19 2700K	A19	E26 Med	8
	97508S	8w LED A19 4000K	A19	E26 Med	8
	97309S	13.5w LED A19 3000K	A19	E26 Med	13.5
	97409S	13.5w LED A19 2700K	A19	E26 Med	13.5
	97509S	13.5w LED A19 4000K	A19	E26 Med	13.5
	97311S	8w LED PAR20 3000K	PAR20	E26 Med	8
	97411S	8w LED PAR20 2700K	PAR20	E26 Med	8
	97511S	8w LED PAR20 4000K	PAR20	E26 Med	8
	97314S	15w LED PAR30L 3000K	PAR30L	E26 Med	15
	97414S	15w LED PAR30L 2700K	PAR30L	E26 Med	15
	97514S	15w LED PAR30L 4000K	PAR30L	E26 Med	15

Finish representations in this catalog are shown using high resolution digital reproduction, and while every effort has been made to render colors accurately, some may vary slightly from the actual product, especially hand-painted finishes due to the nature of hand craftsmanship.

Light bulbs are not included with lighting fixture products shown in this catalog, unless otherwise noted. Sea Gull Lighting reserves the right, at any time to make changes in the construction and design of products listed without notice. The changes may be necessary by law or the availability of supplies.

# Lamp Reference Chart

Watts Consumed	Rated Life (Hours)	Beam Spread	Light Output (Lumens)	CRI	Color Temperature (°K)	ENERGY STAR®
13	10,000	n/a	900	>81	2700	Y
20	2,000	FL 24°	160	>90	2700	N
20	2,000	FL 38°	160	>90	2700	N
35	2,000	FL 24°	240	>90	2700	N
35	2,000	FL 38°	240	>90	2700	N
50	2,000	FL 24°	450	>90	2800	N
50	2,000	FL 38°	450	>90	2800	N
20	2,000	FL 38°	140	>90	2700	N
35	2,000	FL 38°	210	>90	2700	N
50	2,000	FL 38°	400	>90	2800	N
35	2,000	n/a	420	>90	2550	N
40	2,000	n/a	520	>90	2600	N
35	2,000	n/a	420	>90	2650	N
6	35,000 to 70%	FL 40°	325	>85	3000	Y
6	35,000 to 70%	FL 40°	315	>85	2700	Y
6	35,000 to 70%	FL 40°	345	>85	4000	Y
8	50,000 to 70%	360°	450	>85	3000	Y
8	50,000 to 70%	360°	450	>85	2700	Y
8	50,000 to 70%	360°	475	>85	4000	N
13.5	50,000 to 70%	360°	800	>85	3000	Y
13.5	50,000 to 70%	360°	800	>85	2700	Y
13.5	50,000 to 70%	360°	850	>85	4000	N
8	50,000 to 70%	FL 40°	350	>85	3000	Y
8	50,000 to 70%	FL 40°	310	>85	2700	N
8	50,000 to 70%	FL 40°	365	>85	4000	Y
15	50,000 to 70%	FL 40°	720	>85	3000	Y
15	50,000 to 70%	FL 40°	700	>85	2700	Y
15	50,000 to 70%	FL 40°	770	>85	4000	Y

# Index

<b>4000</b>		9470-12	18	<b>90000</b>		94464-12	21
4975BLE-15	62	9470-15	18	90842-12	59	94465-12	21
4976BLE-15	62	9471-12	18	90842-15	59	94511-71	83
4977BLE-15	62	9471-15	18	90843-12	59	94512-71	82
4978BLE-15	62	9472-12	18	90843-15	59	94513-71	83
4979BLE-15	62	9472-15	18	90844-12	59	94514-71	82
		9473-12	18	90844-15	59	94515-965	83
<b>9000</b>		9473-15	18	90845-12	59	94516-965	82
9027-15	63	9481-12	20	90845-15	59	94517-965	83
9357-12	89	9481-15	20	90846-12	59	94518-965	82
9357-15	89	9485-12	42	90846-15	59	94535-71	72
9373-12	18	9485-15	42			94536-71	72
9373-15	18	9485-171	42	<b>94000</b>		94537-965	72
9380-12	19	9485-962	42	94035-12	18	94538-965	72
9380-15	19	9487-12	89	94035-15	18	94552-71	69
9409-12	88	9487-15	89	94062-12	21	94552-965	69
9409-15	88	9488-12	20, 31, 37, 44, 92	94062-12	21	94553-71	69
9412-12	88	9488-15	20, 31, 37, 44, 92	94064-12	21	94553-965	69
9412-15	88	9727	14, 94	94065-12	21	94554-71	69
9414-12	44	9728	14, 94	94130-12	76	94554-965	69
9414-15	44	9729	14, 94	94223-699	71	94555-71	69
9414-171	44	9731	14, 94	94227-6011	71	94555-965	69
9414-33	44	9732	14, 94	94228-6026	71	94560-71	68
9414-962	44	9774	14, 42, 88, 94	94229-6028	71	94561-71	68
9417-12	17	9775	14, 42, 88, 94	94229-6029	71	94562-965	68
9417-15	17	9776	14, 42, 88, 94	94229-6030	71	94563-965	68
9424-12	88	9777	14, 42, 88, 94	94230-6032	70	94570-71	69
9424-15	88	9778	14, 42, 88, 94	94233-6035	71	94570-965	69
9426-12	88	9784	88, 94	94235-6037	71	94571-71	69
9426-15	88	9787	16, 88, 94	94290-6066	70	94571-965	69
9428-12	15	9789	16, 88, 94	94323-12	11, 13	94620-71	69
9428-15	15	9830-12	11, 13	94323-15	11, 13	94620-965	69
9431-94	19	9830-15	11, 13	94353-645	70	94621-71	69
9433-15	15	9835-12	17	94353-648	70	94621-965	69
9435-12	18	9835-15	17	94363-645	75	94720-71	73
9435-15	18	9858-12	42	94363-649	75	94720-965	73
9438-12	19	9858-15	42	94364-71	75	94726-71	73
9438-15	19	9858-171	42	94364-98	75	94726-965	73
9439-12	19	9858-962	42	94370-607	71	94727-71	73
9439-15	19	9862	19	94371-6121	71	94727-965	73
9443-12	18	9874-15	18	94372-6125	70	94729-71	72
9443-15	18	9888-12	46	94373-6123	70	94729-965	72
9445-12	19	9888-15	46	94373-6124	70	94730-71	72
9445-15	19	9888-171	46	94374-6137	70	94730-965	72
9446-12	19	9888-962	46	94375-6135	70	94731-71	72
9446-15	19	9889-12	46	94377-6125	70	94731-965	72
9447-12	19	9889-15	46	94377-6131	70	94806-71	78
9447-15	19	9889-171	46	94380-841	71	94806-965	78
9448-12	19	9889-962	46	94380-962	71	94807-71	78
9448-15	19	9890-12	46	94381-6133	70	94807-965	78
9450	19	9890-15	46	94385-6121	75	94840-71	76
9451-12	44	9890-171	46	94386-6133	74	94840-965	76
9451-15	44	9890-962	46	94387-607	75	94841-71	76
9451-171	44			94388-841	75	94841-965	76
9451-962	44	<b>40000</b>		94388-962	75	94842-71	76
9452-12	44	49090BL-15	60	94391-6125	74	94842-965	76
9452-15	44	49090BL-171	60	94391-6131	74	94843-71	77
9452-171	44	49090BL-760	60	94392-6135	74	94843-965	77
9452-962	44	49091BL-15	60	94393-6125	74	94844-71	77
9454-12	22	49091BL-171	60	94395-6123	74	94844-965	77
9456-12	22	49091BL-760	60	94395-6124	74	94845-71	77
9458-12	23	49092BL-15	60	94398-6137	74	94845-965	77
9459-12	20, 31, 37, 44	49092BL-171	60	94460-12	21	94846-71	77
9459-15	20, 31, 37, 44	49092BL-760	60	94461-12	21	94846-965	77
9469-12	18	49093BL-15	60	94462-12	21	94847-71	76
9469-15	18	49093BL-171	60	94463-12	21	94847-965	76
		49093BL-760	60				

94848-71	78	97118-32	12, 94	98595SW-15	52	98660S-98	31
94848-965	78	97118-33	12, 94	98596SW-15	52	98662S-12	30
94849-71	78	97119-32	12, 94	98600SW-15	54	98675SW-12	28
94849-965	78	97119-33	12, 94	98600SW-787	54	98675SW-15	28
94850-71	77	97120-32	12, 94	98600SW-986	54	98676SW-12	28
94850-965	77	97120-33	12, 94	98601SW-15	54	98676SW-15	28
94851-71	77	97121-32	12, 94	98601SW-787	54	98677SW-12	28
94851-965	77	97121-33	12, 94	98601SW-986	54	98677SW-15	28
94852-71	78	97122-33	12, 94	98602SW-15	54	98678SW-12	28
94852-965	78	97170	96	98602SW-787	54	98678SW-15	28
94853-71	78	97171	96	98602SW-986	54	98681SW-12	28
94853-965	78	97175	96	98605SW-12	28	98681SW-15	28
94854-71	77	97176	96	98605SW-15	28	98682SW-12	28
94854-965	77	97180	96	98606SW-12	28	98682SW-15	28
94855-71	77	97181	96	98606SW-15	28	98683SW-12	28
94855-965	77	97185	96	98607SW-12	28	98683SW-15	28
94856-71	77	97186	96	98607SW-15	28	98684SW-12	28
94856-965	77	97187	96	98608SW-12	28	98684SW-15	28
94857-71	77	97190-32	59, 96	98608SW-15	28	98700S-986	8
94857-965	77	97304S	96	98611SW-12	28	98701S-986	8
94858-71	78	97305S	16, 94	98611SW-15	28	98702S-986	8
94858-965	78	97308S	96	98612SW-12	28	98703S-986	8
94859-71	78	97309S	96	98612SW-15	28	98852SW-12	39
94859-965	78	97311S	96	98613SW-12	28	98852SW-15	39
94860-71	77	97314S	96	98613SW-15	28	98852SW-787	39
94860-965	77	97404S	96	98614SW-12	28	98852SW-986	39
94861-71	77	97405S	16, 94	98614SW-15	28	98853SW-12	39
94861-965	77	97408S	96	98620S-12	56	98853SW-15	39
94862-71	78	97409S	96	98620S-15	56	98853SW-787	39
94862-965	78	97411S	96	98622S-12	56	98853SW-986	39
94863-71	78	97414S	96	98622S-15	56	98859SW-12	36
94863-965	78	97504S	96	98623S-12	56	98859SW-15	36
94882-71	80	97505S	16, 94	98627S-12	56	98859SW-787	36
94883-71	80	97508S	96	98627S-15	56	98859SW-986	36
94895-71	72	97509S	96	98628S-12	56	98860SW-12	36
94895-965	72	97511S	96	98628S-15	56	98860SW-15	36
94896-71	72	97514S	96	98629S-12	56	98860SW-787	36
94896-965	72			98629S-15	56	98860SW-986	36
94897-71	80	<b>98000</b>		98630S-12	56	98862SW-12	39
94897-965	80	98040-15	58	98630S-15	56	98862SW-15	39
94898-71	80	98040-787	58	98631S-12	56	98862SW-787	39
94898-965	80	98040-986	58	98631S-15	56	98862SW-986	39
		98041-15	58	98640S-12	38	98863SW-12	39
		98041-787	58	98640S-15	38	98863SW-15	39
		98041-986	58	98641S-12	37	98863SW-787	39
		98042-15	58	98641S-15	37	98863SW-986	39
		98042-787	58	98643S-12	37		
		98042-986	58	98643S-15	37		
		98043-15	58	98644S-12	37		
		98043-787	58	98644S-15	37		
		98043-986	58	98645S-12	37		
		98050-12	31	98645S-15	37		
		98051-12	31	98646S-12	37		
		98054-12	22	98646S-15	37		
		98055-12	23	98647S-12	31, 37, 56		
		98055-15	23	98647S-15	31, 37, 56		
		98061-12	31	98650S-12	30		
		98062-12	31	98651S-12	30		
		98159-12	22	98652S-12	30		
		98159-15	22	98653S-12	30		
		98175-12	45	98654S-12	30		
		98175-15	45	98655S-12	30		
		98176-12	22, 45	98656S-12	30		
		98176-15	22, 45	98657S-12	30		
		98593SW-15	52	98658S-12	30		
		98594SW-15	52	98659S-12	30		
<b>96000</b>							
96116S-32	10, 94						
96116S-33	10, 94						
96117S-32	10, 94						
96117S-33	10, 94						
96118S-32	10, 94						
96118S-33	10, 94						
96119S-32	10, 94						
96119S-33	10, 94						
96120S-32	10, 94						
96120S-33	10, 94						
96121S-32	10, 94						
96121S-33	10, 94						
96223S-12	22, 38						
96223S-15	22, 38						
96224S-12	23						
96224S-15	23						
<b>97000</b>							
97004	16, 94						
97032-32	96						
97037-32	96						
97102	96						



# Sea Gull Lighting®

*Life Illuminated* | Since 1919

Since 1919 Sea Gull Lighting has been developing sensibly styled, affordable, decorative lighting for builders, contractors and value-minded consumers. Seeing a need for a more advanced, lower profile, under-cabinet lighting system, Sea Gull Lighting created Ambiance Lighting Systems and launched the best-selling Lx Cable System in 1993.





**AMBIANCE.**  
Lighting Systems

7400 Linder Ave.  
Skokie, IL 60077

Phone: 800.347.5483  
Fax: 800.877.4855

[Ambiance-Lighting.com](http://Ambiance-Lighting.com)

AMB13

© 2013 Sea Gull Lighting LLC, A Generation Brands Company