



STEALTH Sensor with twin precision die cast H101 Deluxe shielded floods pre-wired and assembled on universal CU4 cover plate.

Color: White

Weight: 4.8 lbs

Project:	Type:
Prepared By:	Date:

Technical Specifications

Listings

UL Listing:

Suitable for wet locations

Electrical

Power Consumption:

1W

Surge Protection:

Withstands up to 6000 volts

Wall Switch Manual Override:

Two flip logic prevents activation by momentary power outages. Override resets to auto at dawn. No extra wiring needed.

RF Immunity:

Circuits fully shielded for maximum radio frequency immunity

Voltage:

120 Volts AC 60 Hertz

Switching Capacity:

1000 watts incandescent @ 120 volts, 8 amps

Sensor Characteristics

Time Adjustment:

5 seconds to 12 minutes

Wide Sensitivity Control:

Adjustable from 100% to 30%

Advanced Detection Logic:

Minimizes false triggers

Photoelectric Control:

Deactivates lights during daylight. Fully adjustable for 24 hour operation or custom applications.

Detection:

200° view

Construction

Temperature Compensation:

Sensitivity adjusts automatically for consistent detection in hot and cold ambient temperatures

Horizontal Lock, No-tool Joints:

Keeps sensing pattern level for fast, error-free installation

Floodlights:

Precision die cast aluminum. 1/2" NPS threaded arm with serrated locking swivel fits all standard mounting boxes and covers.

Lens Mask:

Customized press apply lens mask included to reduce coverage easily

LED Characteristics

LED Detection Indicator:

Shows when sensor is detecting in daytime and glows red at night for "on-guard" deterrence

Color Matched Lens:

Dark lens with bronze units, white lens with white units

Optical

Lamp:

Accepts PAR38 lamps, 150 watt max. Lamps are not supplied.

Other

Warranty:

10 year sensor warranty

Buy American Act Compliance:

RAB values USA manufacturing! Upon request, RAB may be able to manufacture this product to be compliant with the Buy American Act (BAA). Please contact customer service to request a quote for the product to be made BAA compliant.

Dimensions

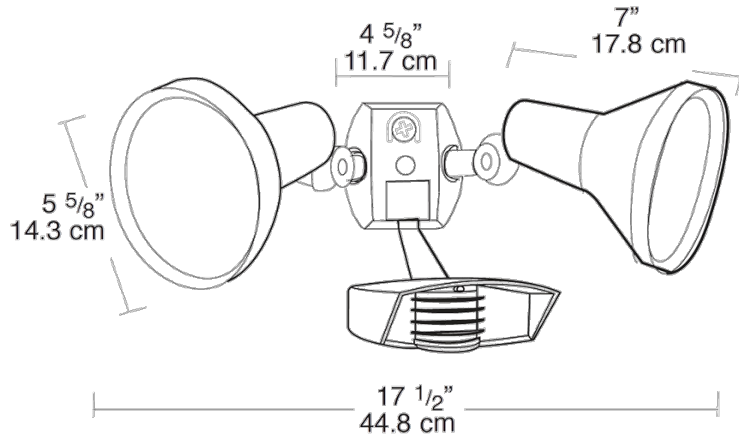

Features

- Temperature compensation
- Radio frequency immunity
- 6000 volt surge protection
- LED detection & "on guard" indicator
- Color matched vandal resistant lens and grill
- Protected manual override with auto reset
- Can be wired in parallel