

LL322VG

Rugged die cast aluminum 6" diameter housings. Threaded, gasketed clear glass globe for durable weatherproofing and easy relamping. 1" long, 1/2" threaded nipple included for easy mounting. 75 watt max. incandescent lamp not supplied. Fluorescent lamp supplied.

Color: Verde green

Weight: 2.1 lbs

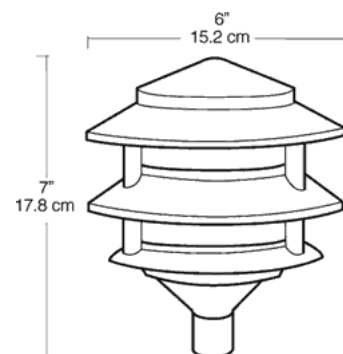

Lamp Info

Type: A-19
 Watts: 75W
 Shape/Size: N/A
 Base: N/A
 ANSI: N/A
 Hours: 750
 Lamp Lumens: 1,220
 Efficacy: N/A

Ballast Info

Type: N/A
 120V: N/A
 208V: N/A
 240V: N/A
 277V: N/A
 Input Watts: 0W
 Efficiency: N/A

Technical Specifications

UL Listing:

Suitable for wet locations. Suitable for mounting within 4 feet of the ground.

Socket:

Medium base porcelain with all copper electrical parts and 20" leads, including a ground lead.

Globes:

Threaded, gasketed globe protects against weather, garden sprinklers and insects. Clear glass GL 100 globes standard for 4 Tier. Clear glass GL60 globes standard for 3 Tier. GL100 white globes also available for attractive appearance and glare reduction.

Housing:

Die cast aluminum housing with powder coat finish.

Voltage:

120 volts AC

Mounting Stem:

Optional 12" mounting stem with 1/2" threads on both ends available .

Lamp:

Incandescent lamp not supplied. Medium base A-19 lamps, 120V. 75 watt max.

Patents:

RAB sensor and fixture designs are protected under U.S. and International Intellectual Property laws.