

FF100

Compact, tough and good looking cast aluminum housing with hinged framed glass lens. Integra Hood glare shield and stainless steel clip. Lamp supplied.

Color: Bronze

Weight: 7.5 lbs

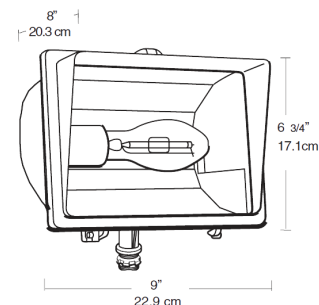

Lamp Info

Type: ED17
 Watts: 100W
 Shape/Size: N/A
 Base: N/A
 ANSI: N/A
 Hours: 24,000
 Lamp Lumens: 9,500
 Efficacy: 83 LPW

Ballast Info

Type: R-NPF 120V
 120V: 3.1/2.1A
 208V: N/A
 240V: N/A
 277V: N/A
 Input Watts: 115W
 Efficiency: 87%

Technical Specifications

UL Listing:

Suitable for wet locations. Suitable for mounting within 1.2m (4ft) of the ground.

Sockets:

Porcelain with all copper current carrying components.

Housing:

Precision die cast aluminum, 1/2" NPS threaded arm with locking swivel fits all standard mounting boxes .

Reflector:

Anodized semi-specular aluminum.

Lens:

Thermal tempered shock resistant glass.

Lens Gasket:

High temperature tubular silicone set in die cast retaining groove remains in place during relamping .

Socket:

Glazed porcelain 4kv pulse rated with nickel plated screw shell and spring contacts .

Finish:

Our environmentally friendly polyester powder coatings are formulated for high-durability and long-lasting color, and contains no VOC or toxic heavy metals.

EPA:

0.43.

Patents:

Pat. D420,458.