

Sensor/actuator connector - SACC-M12FS-4QO-0,34 - 1641701

Please be informed that the data shown in this PDF Document is generated from our Online Catalog. Please find the complete data in the user's documentation. Our General Terms of Use for Downloads are valid (<http://phoenixcontact.com/download>)



Sensor/actuator connector, Universal, 4-position, Socket straight M12, Coding: A, Insulation displacement connection, knurl material: Plastic, external cable diameter 3.5 mm ... 6 mm

Your advantages

- Safe use in the field, thanks to a high degree of protection
- Flexible: connectors for on-site assembly
- Insulation displacement connection: innovative and time-saving assembly without stripping the single wire

RoHS

Key Commercial Data

Packing unit	1 pc
GTIN	 4 017918 925154
GTIN	4017918925154

Technical data

Dimensions

Wrench size, union nut	13 mm
Diameter housing	16.3 mm
Length	51 mm
External cable diameter	3.5 mm ... 6 mm
Stripping length of the sheath	40 mm

Ambient conditions

Ambient temperature (operation)	-25 °C ... 80 °C (Plug / socket)
Ambient temperature (assembly)	-5 °C ... 50 °C (During assembly)
Degree of protection	IP65
	IP67

General

Note	NOTE: Observe the permissible bending radii when laying conductors, since the degree of protection may be put in jeopardy if the bending
------	--

Sensor/actuator connector - SACC-M12FS-4QO-0,34 - 1641701

Technical data

General

	forces are too high. Alleviate mechanical loads upstream of the connector, e.g. by using cable ties.
Rated current at 40°C	4 A
Rated voltage	125 V AC
	125 V DC
Number of positions	4
Color handle area	black
Insulation resistance	≥ 100 MΩ
Coding	A - standard
Standards/regulations	M12 connector according to IEC 61076-2-101
Signal type/category	Universal
Status display	No
Overvoltage category	III
Degree of pollution	3
Connection method	Insulation displacement connection
Conductor cross section	0.14 mm² ... 0.34 mm²
Conductor cross section AWG	26 ... 22
Wire diameter including insulation	0.7 mm ... 1.6 mm
Frequency of connections between conductors of the same cross section	10
Wire insulation material	PVC / PE / PP / rubber
Structure of individual litz in acc. with VDE 0295 / smallest wire diameter	Class 2-6
Insertion/withdrawal cycles	≥ 100
Torque	0.4 Nm (M12 knurl)
	1.2 Nm (Pressure nut)
Assembly instructions	AWG 20 conductor cross section upon request

Material

Flammability rating according to UL 94	V0
Contact material	CuSn
Contact surface material	Ni/Au
Contact carrier material	TPU
Material of grip body	PA 6
Material, knurls	Plastic
Sealing material	NBR

Standards and Regulations

Standards/specifications	M12 connector according to IEC 61076-2-101
Connection in acc. with standard	CUL
Flammability rating according to UL 94	V0

Environmental Product Compliance

China RoHS	Environmentally friendly use period: unlimited = EFUP-e
------------	---

Sensor/actuator connector - SACC-M12FS-4QO-0,34 - 1641701

Technical data

Environmental Product Compliance

	No hazardous substances above threshold values
--	--

Drawings

Dimensional drawing

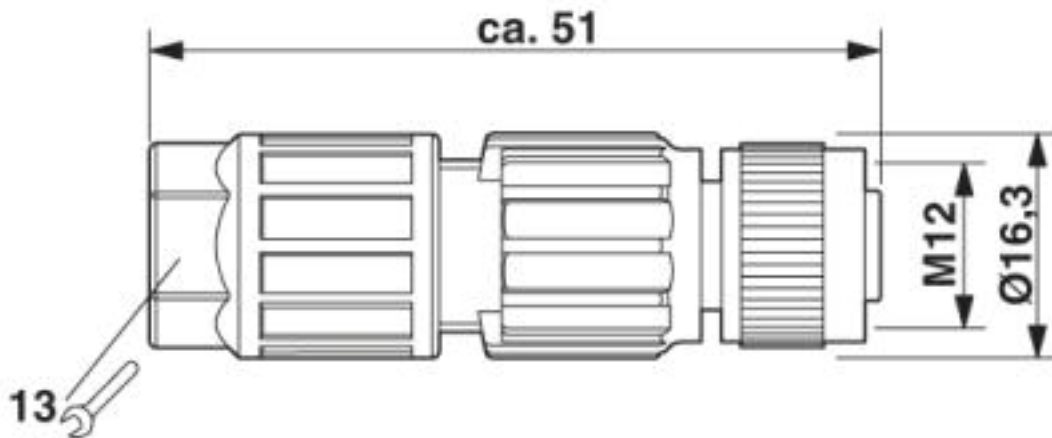

M12 x 1 socket, straight

Sensor/actuator connector - SACC-M12FS-4QO-0,34 - 1641701

Schematic diagram

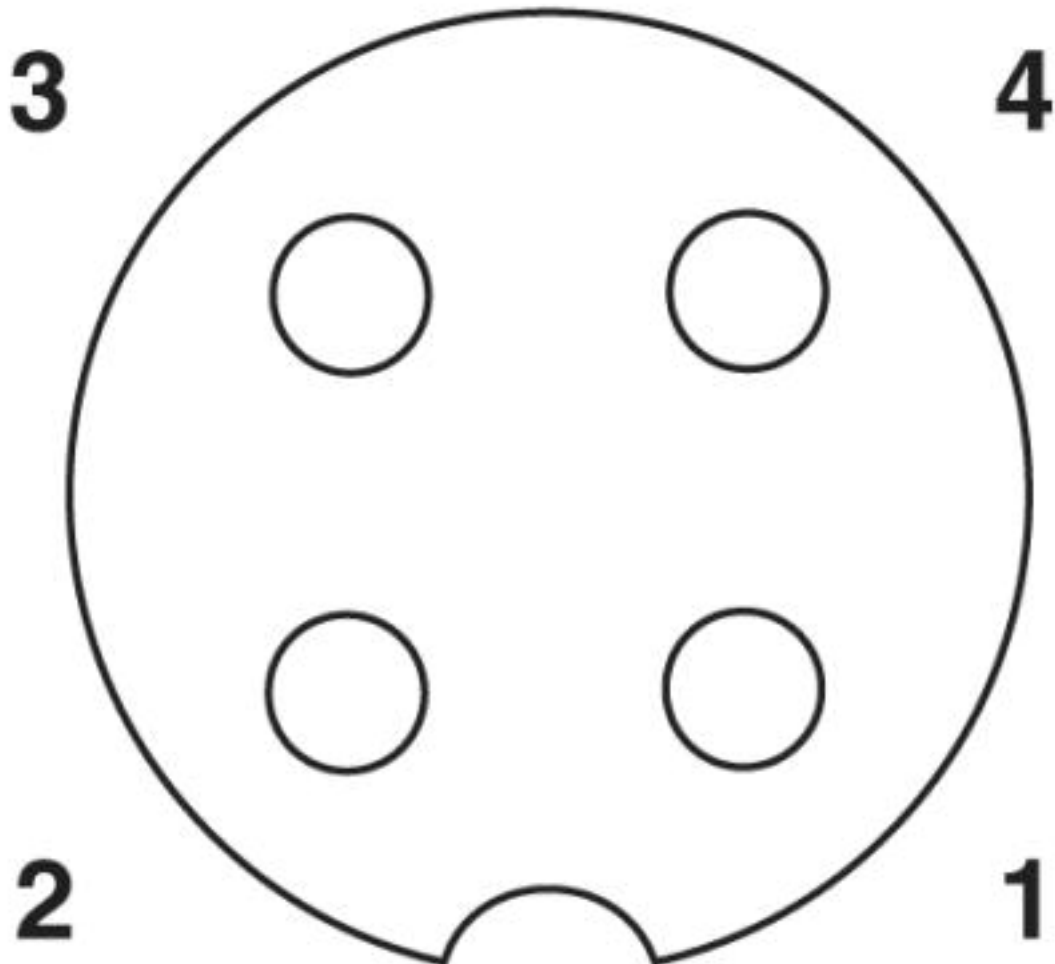

Pin assignment M12 socket, 4-pos., A-coded, view female side

Sensor/actuator connector - SACC-M12FS-4QO-0,34 - 1641701

Functional drawing

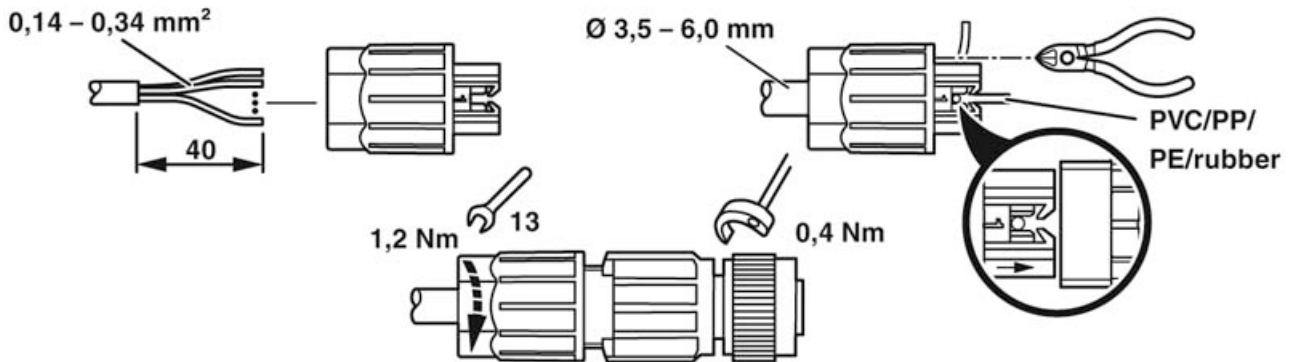

Classifications

eCl@ss

eCl@ss 10.0.1	27440102
eCl@ss 4.0	27140800
eCl@ss 4.1	27140800
eCl@ss 5.0	27143400
eCl@ss 5.1	27143400
eCl@ss 6.0	27279200
eCl@ss 7.0	27440104
eCl@ss 8.0	27440104
eCl@ss 9.0	27440102

ETIM

ETIM 2.0	EC000516
ETIM 3.0	EC000516
ETIM 4.0	EC002062
ETIM 5.0	EC002062
ETIM 6.0	EC002062

UNSPSC

UNSPSC 6.01	31261501
UNSPSC 7.0901	31261501
UNSPSC 11	31261501
UNSPSC 12.01	31261501

Sensor/actuator connector - SACC-M12FS-4QO-0,34 - 1641701

Classifications

UNSPSC

UNSPSC 13.2	39121413
UNSPSC 18.0	39121413
UNSPSC 19.0	39121413
UNSPSC 20.0	39121413
UNSPSC 21.0	39121413

Approvals

Approvals

Approvals

UL Recognized / cUL Recognized / EAC / EAC / cULus Recognized

Ex Approvals

Approval details

UL Recognized		http://database.ul.com/cgi-bin/XYV/template/LISEXT/1FRAME/index.htm	FILE E 118976
Nominal voltage UN		300 V	
Nominal current IN		4 A	

cUL Recognized		http://database.ul.com/cgi-bin/XYV/template/LISEXT/1FRAME/index.htm	FILE E 118976
Nominal voltage UN		300 V	
Nominal current IN		4 A	

EAC		EAC-Zulassung
-----	---	---------------

EAC		RU C- DE.BL08.B.00511
-----	---	--------------------------

Sensor/actuator connector - SACC-M12FS-4QO-0,34 - 1641701

Approvals

cULus Recognized



Accessories

Accessories

Cable by the meter

Cable reel - SAC-4P-100,0-PUR/0,25 - 1501692



Cable ring, PUR halogen-free black, 4-pos., conductor colors: brown / white / blue / black, cable length: 100 m

Cable reel - SAC-4P-100,0-PUR/0,34 - 1501663



Cable ring, PUR halogen-free black, 4-pos., conductor colors: brown / white / blue / black, cable length: 100 m

Plug for cable screw gland

Screw plug - PROT-M12 MS-PA-CHAIN - 1430899

M12 sealing cap with fixing band, for sensor cables, for free M12 sockets



Screwdriver tools

Tool - SAC BIT M12-D15 - 1208432



Nut for assembling sensor/actuator cables with M12 connector and M12 connectors for assembly, with a knurl diameter of 15 mm, for 4 mm hexagonal drive

Sensor/actuator connector - SACC-M12FS-4QO-0,34 - 1641701

Accessories

Adapter insert - TSD-M SAC-BIT ADAPTER - 1212600



Adapter bit for TSD-M...torque tools, E6.3-1/4" drive with 4 mm hexagon to accommodate SAC bits

Tool - SAC BIT QUICKON-W13 - 1212033



Nut for assembling pressure nuts with 13 mm wrench size, for 4 mm hexagonal drive

Torque tool

Torque screwdriver - TSD 04 SAC - 1208429



Torque screwdriver, with preset torque of 0.4 Nm and 4 mm hexagonal drive for M12 connectors

Torque screwdriver - TSD-M 1,2NM - 1212224



Torque screw driver, accuracy as per EN ISO 6789 standard, adjustable from 0.3 - 1.2 Nm

Phoenix Contact 2020 © - all rights reserved
<http://www.phoenixcontact.com>

PHOENIX CONTACT GmbH & Co. KG
Flachsmarktstr. 8
32825 Blomberg
Germany
Tel. +49 5235 300
Fax +49 5235 3 41200
<http://www.phoenixcontact.com>