

Unity System Technical Manual

Software Version 2.2.x





Unity System Technical Manual

Software Version 2.2.x

P/N 1308112 Revision B



FCC Certifications

This equipment generates and uses radio frequency energy and if not installed and used properly, that is, in strict accordance with the instructions provided with the equipment, may cause interference to radio and TV communication. The equipment has been tested and found to comply with the limits for a Class B digital device in accordance with the specifications in Subpart B of Part 15 of FCC rules, which are designed to provide reasonable protection against such interference in a residential installation. However, there is no guarantee that interference will not occur in a particular installation. If you suspect this equipment is causing interference, turn your Router/Switch on and off while your radio or TV is showing interference, if the interference disappears when you turn your Router/Switch off and reappears when you turn it back on, there is interference being caused by the Router/Switch.

You can try to correct the interference by one or more of the following measures:

- ◆ Reorient the receiving radio or TV antenna where this may be done safely.
- ◆ To the extent possible, relocate the radio, TV or other receiver away from the Router/Switch.
- ◆ Plug the Router/Switch into a different power outlet so that the Router/Switch and the receiver are on different branch circuits.

If necessary, you should consult the place of purchase or an experienced radio/television technician for additional suggestions.

Important Safety Instructions

Read these operating instructions carefully before using the unit. Follow the safety instructions on the unit and the applicable safety instructions listed below. Keep these instructions for future reference.

- A. Read these instructions.
2. Keep these instructions.
3. Heed all warnings.
4. Follow the instructions.
5. Do not use this apparatus in or near water.
6. Clean only with a dry cloth.
7. Do not block any ventilation openings. Install in accordance with the manufacturer's instructions.
8. Do not install near any heat sources such as radiators, heat registers, stoves, or other apparatus (including amplifiers) that produce heat.
9. Do not defeat the safety purpose of the polarized or grounding-type plug. A polarized plug has two blades with one blade larger than the other. A grounding-type plug has two blades and a third grounding prong. If the provided plug does not fit into your outlet, consult an electrician for replacement of the obsolete outlet.
10. Protect any cords, including network cords, from being walked on or pinched.
11. Use only attachments/accessories specified by the manufacturer.
12. Unplug this apparatus during lightning storms or when unused for long periods of time.
13. Refer all servicing to qualified service personnel. Servicing is required when the apparatus has been damaged in any way, such as power plug damage, liquid spills or objects falling onto the apparatus. Also, if the apparatus has been exposed to rain or moisture, does not operate normally, or has been dropped.

Warning: To reduce the risk of fire, electric shock, or product damage, do not expose this apparatus to rain, moisture, immersion, dripping or splashing. No objects filled with liquids, such as vases, should be placed on this apparatus.

Caution:

- **Do not install or place this unit in a bookcase, built-in cabinet, or in another confined space without adequate ventilation.**
- **Do not obstruct the unit's ventilation openings with curtains, fabrics, and similar items.**
- **Do not place sources of open flames such as candles on the unit.**
- **Dispose of batteries in an environmentally friendly manner.**

TABLE OF CONTENTS

I.	Unity System Overview	1
II.	Integration Module Summary Of Connections	2
	A. HA6001 Integration Module Overview	2
	B. HA6101 Integration Expansion Module Overview	3
III.	Unity System Installation Information	4
	A. Infrastructure Installation	4
	B. Pre wiring for Unity	4
	1. Structured Wiring Practices	4
	2. Legrand Best Practices	5
	C. System Configuration	5
	1. What Subsystems are being installed?	5
	2. Number of Units	5
	3. HVAC Control	7
	D. Power Distribution	8
	1. General Recommendations	8
	2. Unity System Specific DC Power Requirements	14
	a. Home Automation	14
	b. Data Distribution	14
	c. Audio Distribution	14
	d. Intercom Distribution	15
	e. Camera Video Distribution	15
	f. Lighting Control	16
	g. HVAC Control	16
	h. Universal Power Distribution	16
	E. Connecting the Network	16
	1. LAN Connections	16
	2. Internet Connectivity	16
	F. Connecting the lyriQ Audio System	17
	1. Single Source (4) Zone	17
	2. Multi Source (8) Zone	18
	3. Multi Source (16) Zone	19
	4. Zone Expansion (Cascade)	20
	G. Connecting the Displays	22
	1. HA5000 (7" LCD Display)	22
	2. HA5009 (Display + built in lyriQ audio 7W/CH)	23
	3. HA5010 (Display + built in Hi Performance lyriQ audio 20W/CH)	24
	4. TVDI (Television Display Interface)	25
	H. Connecting the Cameras	28
	1. 2 Cameras	28
	2. 4 Cameras	29
	I. Connecting the Video Door Units	32
	J. Connecting the Intercom Units	33

1.	Selective Call Intercom	33
2.	Intercom Expansion	34
K.	Connecting a Legrand Radio Frequency Lighting Control (RFLC)	35
L.	Connecting a HVAC Controller	37
M.	Connecting for LCD Expansion	38
1.	HA6101 Integration Expansion Module	38
2.	Intercom / Video Door Cascade Connections	38
3.	Extra LANs	39
4.	Extra Power	40
5.	CM1048 Camera / LCD Combo Module	41
N.	Boot Sequences	46
1.	BOOT-Up Sequence	46
2.	Software UPDATE Process	47
3.	Software RESET Process	47
IV.	Setup Guide For Web and LCD Console	48
A.	Setup The Network	48
B.	Setup the Displays	50
C.	Setup the Cameras	54
D.	Setup Music	55
E.	Setup the Intercom units	60
F.	Setup Messages	66
G.	Setup Groups	67
H.	Setup Player	69
I.	Setup Lighting	70
J.	Setup the System	76
K.	Find Firmware Info	78
L.	Setup Weather	79
M.	Setup Internet Radio	80
N.	Steps for LCD Console ONLY Options	81
1.	Custom Door Chimes	81
2.	Door Messaging	84
3.	Lighting – Performing an RF Scan	86
4.	Lighting – Delete a Zone	87
5.	Setup – Thermostat	88
V.	Technical Troubleshooting	93
A.	Unity Module is not able to Discover Music	93
B.	Unity module is Unable to Boot Up Properly	93
C.	The Unity System has Locked Up	94
D.	Unit Not Discovered Error Message	94
E.	Address Jumpers Incorrect Error Message	94
F.	Camera Images not appearing in Camera Menu	95
G.	Not able to access Music Menu	95
H.	Some IyriQ Volume Controls not appearing in Music Menu	95
I.	Intercom Units not appearing in Intercom Menu	96

J.	Events not Triggering in Sequence or At All	96
K.	RF Lighting – Lights not Appearing in Lighting menu	97
L.	Weather not Pulling Up Data or Showing Out of Date Weather	97
M.	Unity Module Update is not Working	97
N.	Not Able to Access Web Setup	97
VI.	UNITY USER'S GUIDE	99
A.	Basic Navigation	99
B.	Unity Functions	100
1.	Using the Intercom	100
2.	Using the Player	103
3.	Playing Music	110
4.	Creating Events	115
5.	Using Thermostat	122
6.	Using Lighting	124
7.	Using Cameras	127
8.	Using Messages	128
9.	Using Weather	129
VII.	Unity Network Sharing	130
A.	Windows XP	130
B.	Windows Vista	133
C.	Windows 7	138
D.	Mac OS X Leopard/Snow Leopard 10.5.x & 10.6.x	144
E.	Performing a Catalog Action	149
VIII.	Unity Web Control	150
A.	Control	150
1.	Unity Web Control Player	151
2.	Unity Web Control Lighting	163
3.	Music Control	167
B.	Mobile	171
1.	Player	173
2.	Lighting	178
3.	Music	182
IX.	Unity Specifications	188
A.	Absolute Maximum System Limitations	188
B.	Typical System Specifications	190
1.	Single Unity Integration Module	190
2.	LCD Module or Combo/Camera Module	191
3.	SCI Module	192
4.	Integration Expansion module	192

I. Unity System Overview

The Unity Home System, the newest addition to the Studio Collection, is the first home system of its kind. Experience intercom, audio and camera systems, plus messaging and easy set-up, all from an intuitive graphical user interface.

Unity is comprised of two key pieces – the Integration Module and an LCD Console. While the Integration Module houses the “brains” behind the system, the LCD is the primary part of Unity with which a homeowner would interact. It includes an easy-to-use but powerful graphical user interface (GUI) which enables control of their home system – intercom, audio, cameras, lighting, HVAC, etc. – at the touch of a button. The GUI is displayed on a high performance screen and operates similar to a cell phone or iPod, with simple, menu-driven navigation. In addition, Unity allows users to listen to digital music from a networked computer or Internet radio stations, and enables the display of metadata like album artwork on the LCD screen. In addition to the LCD Console, any television in the home can be used to control Unity system via a hand held remote.



Figure 1 – LCD Console

The Integration Module includes convenient Cat5e RJ45 connections for audio, intercom, and camera systems. It not only facilitates direct connection between these systems, but it also enhances the existing systems to deliver additional functionality. For example, when the Selective Call Intercom system is connected to the Integration Module, users are able to leave messages for family members in select rooms, or set up alarms and wake up calls throughout the house or in specific rooms. Unity also enables the intercom system to work with the On-Q camera system to perform automatic camera viewing via the LCD screen when the door button is pressed.

Unity systems can grow from modest homes up to much larger ones. A typical Unity system would include four rooms of intercom, four zones of audio, and one camera. It would also include one LCD Console or TV Display Interface, both of which enable convenient system interaction via graphical user interfaces. This standard system can also be expanded to accommodate a system of up to 32 rooms of

Figure 2 – Unity 4 Room Kit (HA6401-BS)



intercom, sixteen zones of audio, four cameras, two video doors, and eight LCD Consoles or TV Display Interfaces. The Legrand 4 Port Router/Switch (P/N DA1004) is a flexible hardware configurable switch/router product designed to be used as a router with an integrated 4-port Fast

Ethernet switch, or as a 5-port Fast Ethernet switch for use with a 3rd party external router. It is the perfect solution to connect a small group of PCs to a high-speed broadband Internet connection (see **Figure 1**). Up to 253 users can have high-speed Internet access simultaneously via one single IP address (Internet account) of the Cable/xDSL modem. With its built in NAT technology, this product also serves as an Internet firewall, protecting your network from being accessed by outside users. All incoming data packets are monitored and filtered. The Router can also be configured with Client Filtering, to filter internal users' access to the Internet. The built-in 4-port Fast Ethernet Switch lets users plug the network cable into the device without buying additional Hub/Switch.

II. Integration Module Summary of Connections

A. Integration Module Part Number HA6001

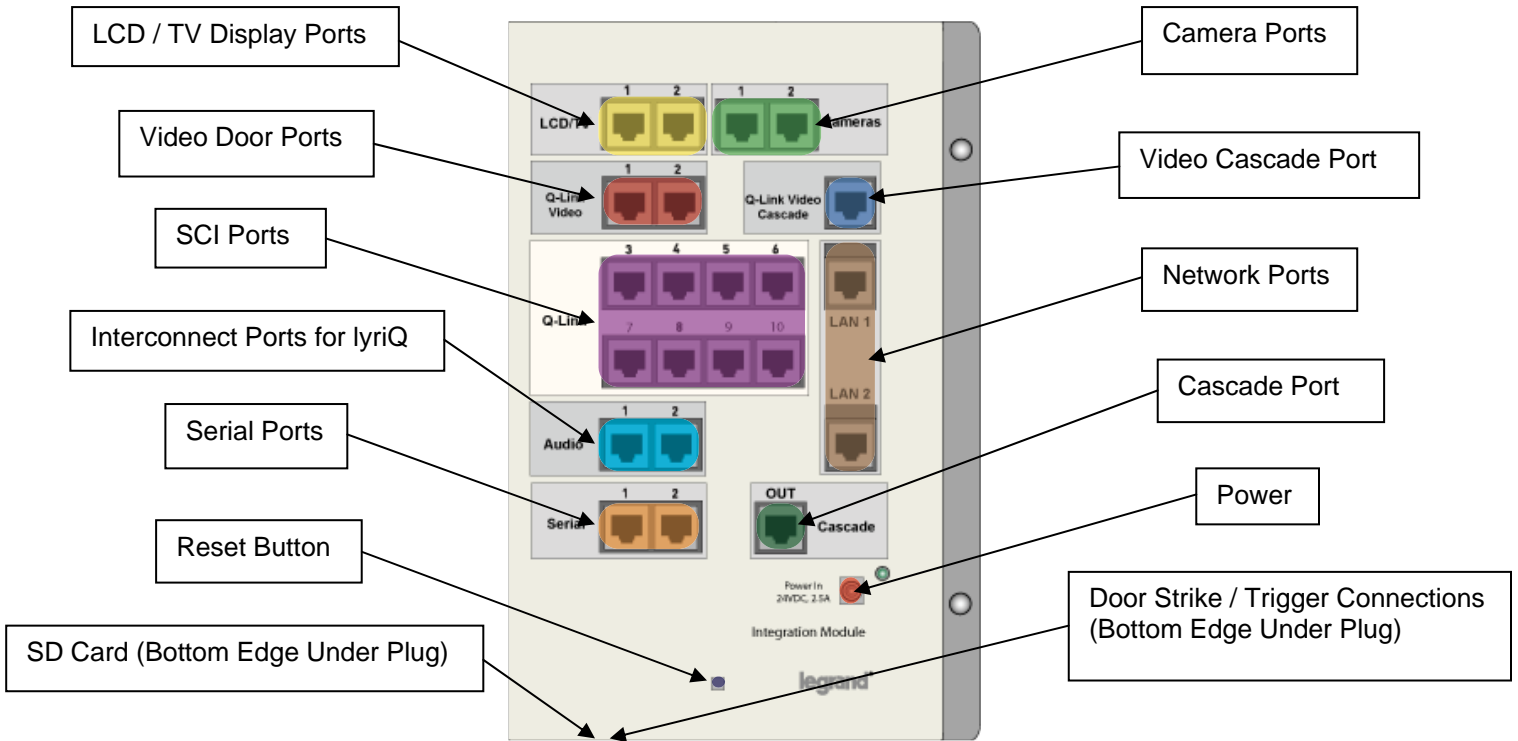

Compatible Devices Listed by Port

LCD / TV Display Ports – HA5000-xx, HA5009-xx, and HA5010-xx LCD Display Consoles, HA5201-xx TV Display Interface, or HA5202 TV Display Interface Expansion Module.

Video Door Ports – IC 5003-xx Selective Call Video Door Units.

SCI Ports – IC5000-xx Selective Call Room Units, IC5002-xx Selective Call Door Units, or IC5004-xx Selective Call Patio Units.

Interconnect Ports for lyriQ – AU1002 lyriQ 4X8 Distribution Module, AU1023 lyriQ 4X8 Zone Expander, or AU1014 lyriQ Advanced Single Source Distribution Module.

Serial Ports – LC2354 RS232 To RJ45 Adapter (Lighting Control – Port 1) and AC1022 RS485 Adapter (HVAC – Port 2).

Reset Button – Press to Restart Unity System. Note: This Does Not Change Any Configurations. For a System Reset to Factory Default, Use Setup : System : Reset .

SD Card – Memory Card Containing Operating System Firmware – Not User Serviceable.

Camera Ports – CM5002-xx Studio Ball Camera, CM1048 Combo Camera Module, or CM1010 LCD Distribution Module.

Video Cascade Port – HA6101 Integration Expansion Module. Allows Cascade of Q-Link Video to Expansion Modules.

Network Ports – Both Must be Connected to Ethernet behind the Same Router (i.e. DA1004 4 Port Enhanced Router / Switch).

Cascade Port - HA6101 Integration Expansion Module or IC5001 Selective Call Distribution Module.

Power – PW1060 24VDC 60W Power Supply or PW1120 / PW1240 Power Supply Kits w/Enclosure Brackets.

Door Strike / Trigger Connections – AC1023 Intercom/Unity Relay . Up To 24VDC 500mA for Solenoid Activation.

B. Integration Expansion Module Part Number HA6101

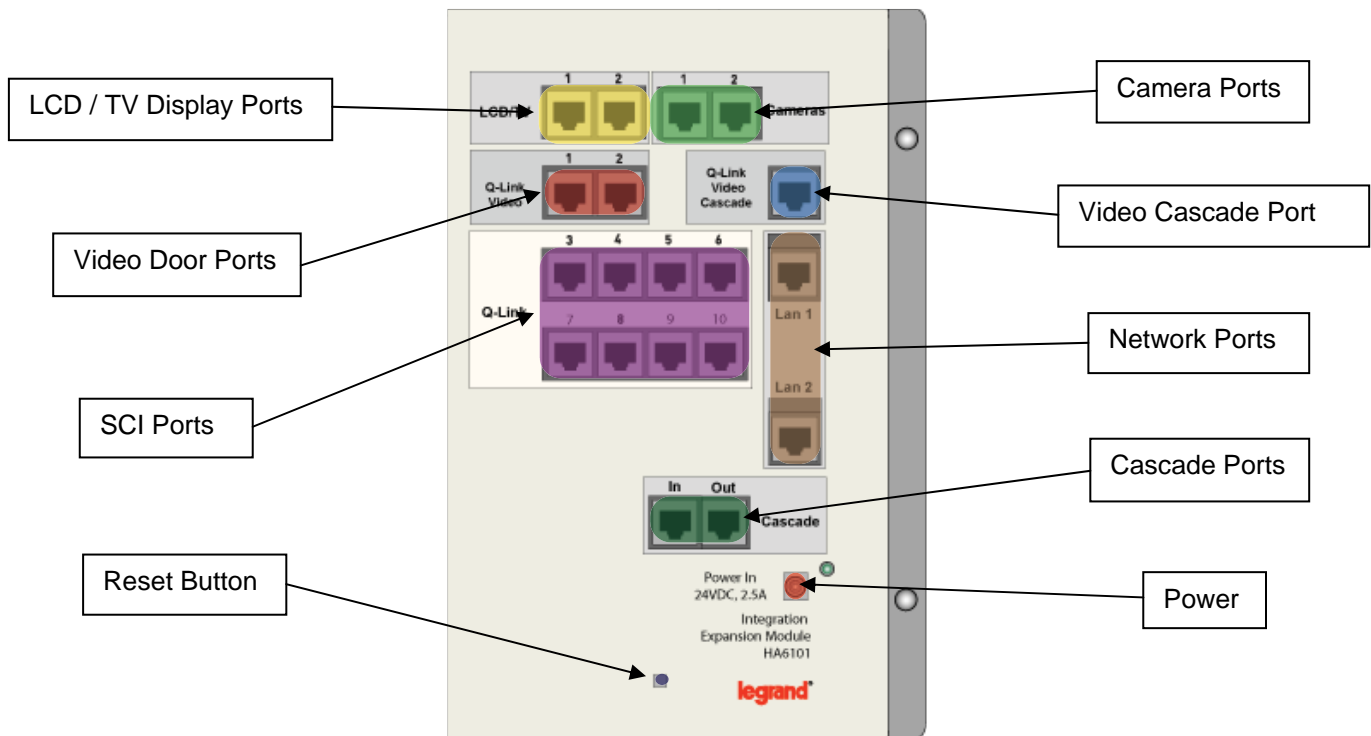

Compatible Devices Listed by Port

LCD / TV Display Ports – HA5000-xx, HA5009-xx, and HA5010-xx LCD Display Consoles, HA5201-xx TV Display Interface, or HA5202 TV Display Interface Expansion Module.

Video Door Ports – Cascade Cable From Video Cascade Port.

SCI Ports – IC5000-xx Selective Call Room Units, IC5002-xx Selective Call Door Units, or IC5004-xx Selective Call Patio Units.

Reset Button – Press to Restart Integration Expansion Module.

Camera Ports – Note: For an Expanded System, All Cameras Must Be Connected Through a CM1010 LCD Distribution Module or CM1048 Combination LCD and Camera Module.

Video Cascade Port – HA6101 Integration Expansion Module. Allows Continuing Cascade of Q-Link Video to Expansion Modules.

Network Ports – Both Must be Connected to Internet behind the Same Router as the HA6001 Integration Module (i.e. DA1004 4 Port Enhanced Router / Switch).

Cascade Ports – Additional HA6101 Integration Expansion Modules Up to 3 Total.

Power – PW1060 24VDC 60W Power Supply or PW1120 / PW1240 Power Supply Kits w/Enclosure Brackets.

III. Unity System Installation Information

The HA6001 Integration Module is **NOT HOT-SWAPPABLE**. i.e. system must be powered down to hook up any component.

A. Infrastructure Installation – It is recommended that the HA6001 Integration Module, and subsystem modules, be installed in a Legrand low voltage enclosure (a.k.a. panel). These enclosures range from 14” to 42” in size. Enclosure size will need to be determined based on system size (number of modules, power supplies, etc). Each enclosure will require a single 14-2 Romex cable providing 110V AC line voltage to a duplex mounted in the bottom of the enclosure. The enclosure should be installed following all State and Local Electrical Code specifications.

1. For installations using HA6001 Integration and HA6101 Expansion modules, the EN4260 42” enclosure(s) is recommended.
 - a. The HA6001 and HA6101 modules are 3 bay sized modules. It is possible to fit (4) 3 bay modules, plus power supplies, into a single EN4260 42” enclosure. However, additional Legrand modules, as well as third party devices, may require a second or even third enclosure to be considered.
 - b. Some homes may have a data network closet or rack that requires data runs to the low voltage enclosure. Be certain to take this into consideration when pre-wiring for the HA6001 module, as an Internet connection is required to perform System Updates, as well as Weather, Time Clock, and Internet Radio functions.
 - c. Customers may choose to have the Internet Modem in a home office rather than in the low voltage enclosure. This is often more convenient for cycling power to the Modem. For this reason it is best to run at-least (1) RG6 Quad Shield Cable, and (1) Cat 5 for telephone, from the low voltage enclosure, to each Room that could be used as a Home Office (including Library, Studies, Dens, and Bedrooms).
2. Legrand recommends the use of a F7526 AC Power Kit and 364771-01 Surge Protection Power module with each enclosure. Multiple Surge Protection Power modules can be installed in a single enclosure. Each Surge Protection Power module will support (6) Legrand power supplies, plus (2) PW1120 (or 1240) power supply kits.
 - a. PW1120 will provide (2) 24V 2.5A power supplies
 - b. PW1240 will provide (4) 24V 2.5A power supplies

B. Pre wiring for Unity – All wiring should follow TIA/EIA standards for low voltage installation. Legrand systems are designed for structured wiring, that is, all Cat 5 cabling is run from a central location (the enclosure) to the various rooms of the home.

1. **Structured Wiring Practices** – The following are guidelines to keep in mind when working with Category 5 (Cat 5) cable.
 - a. Never splice Cat 5 Cable. This eliminates the twists in the wires. The twisted pair wiring is what gives Cat 5 it’s immunity from interference.
 - b. Always maintain a 12” minimum separation between the Cat 5 and any 110VAC cabling. If you must cross an 110VAC electrical circuit, do so at a 90 degree angle.

- c. Always maintain a minimum bend radius of 1" (like bending it around a soda can)
 - d. Never exceed the 25 pound pull limit. Doing so may pull the twists out of the wire.
 - e. Never crush Cat 5 wiring. Doing so may pinch wiring or damage the twists.
 - f. Never leave wires ends exposed, or wiring outside of the wall where it could be damage.
 - g. **IMPORTANT:** Verify all Cat 5 terminations both visually and with a Cat 5 cable tester where applicable. At a minimum, RJ45 terminations should be visually checked for pin proper pin alignment and wire color termination before any product is installed.
 - h. All Legrand products use the T568A Cat5 RJ45 wiring termination
- 2. Legrand Best Practices** – The following outlines Legrand guidelines for product installation.
- a. Legrand recommends the usage of low voltage electrical rings (mud rings) for wall product installation, when available.
 - b. LCD Consoles (HA5000/HA5009/HA5010) and Intercom Units (IC5000/IC5002/IC5003/IC5004) are typically installed 56" from the floor.
 - c. The TV Display Interfaces (T.V.D.I) is typically mounted at outlet height. This could also be mounted behind a wall mounted television. **REMEMBER!** The included IR target must connect to the TVDI, and is 10 foot in length. Plan the location of the T.V.D.I. accordingly.
 - d. All of your cable runs should be limited to 100 meters (328 feet) to ensure maximum performance.
 - e. Always leave a 12" service loop at each device location during rough in. This applies to any device you may be roughing in. Service loops should be secured to studs with tie straps to prevent wire from falling once the walls are installed.
 - f. Always pull enough cable into the enclosure to reach the opposite corner (from where it enters). Typically call low voltage cables will enter from the top of the enclosure to avoid the 110AC cabling entering from the bottom of the enclosure to the Duplex outlet.

C. System Configuration

- 1. What Subsystems are being installed?** – Before any wiring is run, or any product can be installed, the very first step to Installing a Unity system is to determine the subsystems which the customer will be using. These include
- a. Distinct Graphic User Interface (G.U.I.) devices (LCD Console and TVDI)
 - b. Cameras
 - c. Distributed Audio (lyriQ)
 - d. Lighting
 - e. Data network
 - f. HVAC Control
- 2. Number of Units** – The next step after determining what systems are right for the customer is to determine the locations within the home that will receive each system.
- a. **HA5000/HA5009/HA5010 LCD Consoles** – Typically the 7" LCD display will be installed in a Kitchen/Great Room, Office, Master suites, or any other locations

requiring Intercom, Camera viewing, and full control of Lighting, Music, HVAC, etc. The HA5009 and HA5010 have built in amplification to power an external pair of speakers with lyriQ audio.

- b. **HA5201 Television Display Interface (TVDI)**– Typically the will be installed in bedrooms, media/game rooms, theaters, or any area that has a Television or Display device and full control of Lighting, Music, HVAC, etc is desired.
 - i. The TVDI does not provide Intercom functionality. It is recommended that locations where the TVDI are installed should also receive an IC5000 Intercom Room Unit to provide Intercom functionality.
 - ii. It is not recommended to install the LCD Console and TVDI in the same Room, as both devices will respond to IR remote control commands. Remote control functions seen by both devices at the same time may cause undesired system behavior.
- c. **CM5002 Ball Cameras** – Typically these devices are installed outside the home under eve, at an entryway, driveway, and backyard locations. These are also typically installed inside the home in a baby’s room, an elder or disabled person’s room, play rooms, or wherever video/audio monitoring is desired from the LCD Console or TVDI.
 - i. Today monitoring of Cameras from outside the home requires the use of CM1019 IP Video Server. Refer to the following solution for system wiring requirements for the CM1019. <http://www.legrand.us/Residential/Camera-Solutions/Ultimate-Camera-Solution.aspx>
 - ii. Legrand offers an assortment of other cameras, from Black and White, to Infrared, Camera styles that can be used with the Unity system. Refer to www.legrand.us/redential/Camera-solutions for more information on these products.
- d. **lyriQ Audio System** – The lyriQ Audio system is available in Single Source and Multi Source systems. Both system types are compatible with Unity.
 - i. The AU1014 module will allow for (1) analog Source (i.e. FM Receiver), along with the digital audio content from the Unity system (networked Music files and Internet Radio) to be distributed to 4 Zones throughout the home.
 - 1) Each Zone may contain 4 lyriQ Keypads for a total of 16 possible Keypad locations
 - 2) Customer will see 4 Zones to control from the Unity system
 - ii. The AU1002 module allows up to (4) analog Sources, plus the Unity systems digital audio content, to be delivered up to 8 Audio Zones.
 - 1) It is possible to create a 16 Zone Audio system using (2) AU1002 modules and the AU1023 lyriQ Expansion module.
 - 2) Each Zone may contain 4 lyriQ Keypads for a total of 64 possible Keypad locations
 - 3) User will see 16 possible Zones to control from the Unity system.
 - iii. lyriQ keypads can be installed in every area of the home. Typically HA5009 and HA5010 LCD Consoles are reserved for the Kitchen/Great Room areas and Master Suites.

- iv. For more information on lyriQ system possibilities, visit <http://www.legrand.us/Residential/Music-Solutions.aspx>
 - v. More information regarding lyriQ audio product and installation can also be found at <http://www.legrand.us/OnQ/Music.aspx>
 - e. **Radio Frequency Lighting Control (RFLC)** – RFLC can be installed in virtually any location inside the home where the customer desires one touch operation of multiple lights, as well as the convenience of Scenes (Party, Bedtime, Cleanup, etc) and most importantly automated Lighting Control, through user programmed Date/Time/Sunrise/Sunset based Events, from the Unity system.
 - i. The LC2354 Kit is required to interface the RFLC system to the Unity system.
 - ii. For more information on Lighting Solutions, visit <http://www.legrand.us/Residential/RFLC-Lighting-Solutions.aspx>
 - f. **Data Network** – The Data network should always be considered before any Unity installation. Deciding how many Internet connections and Wireless Access Points are required in the home is the first step. Once the customers Data network is planned, the next step is to decide if the customer has a digital music collection they want to share over this network. If so, the customers PC should be setup to allow for sharing of these digital music files (Refer to “Getting Started – Using Player” in this manual.
 - i. Data Network Installation for the HA6001 Integration Module is covered in the Installation Guide Chapter of this manual. Please refer to this section for Data Network example for Unity system.
 - ii. **IMPORTANT:** Each **HA6001** and HA6101 module requires (2) DHCP LAN connections in order to operate properly, as each module must be assigned (2) unique IP addresses.
 - iii. A Wireless Access Point connected to the HA6001 modules Data Network will allow for Control of Lighting, Music System, and the Unity Digital Audio Content (“Player”), from a wireless Laptop, or web enabled Mobile device (Smart Phone, Web Tablet, etc).
- 3. HVAC Control** – Today the Unity system is designed to interface with RCS Brand TR60 Thermostats. This interface (known as Thermostats) is available via the LCD Console and TVDI. Users can view Inside/Outside temperatures, adjust Room temperatures (change Hot/Cold set points), and program schedules.
- a. Up to (3) TR60 thermostats can be displayed and controlled from Unity.
 - i. Today thermostats cannot be remotely controlled or viewed from outside the home.
 - b. Outside temperature will be displayed on the TR60 LCD when an Internet connection is provided to the HA6001 modules Data network.
 - c. Please contact Technical Support (see contact info below) for information regarding setting up the TR60 Thermostats on a Unity system.
 - i. **NOTE:** Special Hardware and Software requirements must be met before the Thermostat option is visible on the Unity G.U.I.

4. For information on Unity System Training, Legrand Product Training, and Installation Training, visit http://www.legrand.us/Education/OnQ/legrand_education_On-Q_coursecatalog.aspx
5. For help with Technical questions and System Design, contact Legrand Home Systems Tech Support at (800)-321-2343, Option #1, or visit <http://www.legrand.us/Support/OnQ/Contact-Warranties.aspx>

D. Unity System – Power Distribution.

The HA6001 Integration Module is NOT HOT-SWAPPABLE. i.e. system must be powered down to hook up any component.

The Unity Integration System was designed such that all required system component low voltage power originates within the Low Voltage Enclosure. System component power is distributed as needed from the Low Voltage Enclosure to specific points of use within the home via basic structured wiring.

1. General Recommendations

- a. Legrand recommends that all Unity Integration Systems be installed utilizing a Low Voltage Enclosure. Legrand Enclosures are designed to natively accommodate the mounting of all Legrand Unity Integration Modules and their required Low Voltage DC Power Sources.
- b. Each individual Unity System Configuration will most likely require a unique power distribution subsystem created within the low voltage enclosure. Specific model number power products and the required quantities needs to be determined after first selecting the Unity System Electronic Modules required to accommodate the desired home automation functions. Determining the Electronic Modules will determine the DC Power Sources required for the installation. Knowing the Electronic Modules and the DC Power Sources will drive the final determination of the size and number of Low Voltage Enclosures required for the installation.
 - i. At this point in the installation planning, careful consideration should be given to subsystem segmentation. It may be desired for the purposes of functional identification, troubleshooting and/or future expansion, to use more than one low voltage enclosure. For example, data networking devices might be located in one enclosure while other functions such as intercom, audio and cameras in another.
- c. Legrand Recommends that all Unity Integration System installations plan to run 110Vac nominal electrical wiring from a 15Amp circuit to each required Low Voltage Enclosure. During installation, the AC wiring shall be used to install an AC duplex outlet inside the Low Voltage Enclosure(s). The Enclosure(s) contains a knockout features for this purpose.
 - i. Legrand offers Model Numbers (F7526 & 364569-02) for this purpose.



AC Outlet, Kit – Model Number (F7526)

- d. Once the AC Duplex has been installed at the Low Voltage Enclosure, Legrand recommends the installation of Surge Protected Power Strip. The Power Strip shall be used to connect various AC to DC power conversion devices to the AC source outlet.
 - i. Legrand offers Model Numbers (364771-01 and 364266-01) for this purpose.



Surge Protection Power Module – Model Number (364771-01)

- e. Now that AC source outlets have been established within the Low Voltage Enclosure, the final step in completing Power Distribution to a Unity System involves selecting, mounting and connecting the AC to DC power supplies to the actual Unity System Modules. Each Unity System Module has a specific minimum power supply requirement. This Module Specific Power Supply information is identified in the following section.
 - i. Legrand Recommends for the most basic Unity System installation the 240W, 24Vdc power kit, (PW1240) and the Universal Power Distribution Module (PW1010).



24Vdc 240W Power Supply Kit – Model Number (PW1240)



Universal Power Distribution Module – Model Number (PW1010)

- ii. The PW1240 Power Kit provides a convenient and compact 24Vdc power density that can supply 24Vdc to up to (4) Unity System Modules by simply connecting the DC Power Plugs to the Modules' DC Power Jacks.



Power Kit Assembly Detail

- iii. The PW1010 Module provides added flexibility by providing a convenient and compact method to convert 24Vdc power from one of the PW1240 Kit Power Supplies to other power voltages required by Legrand Modules or

other third party devices. The PW1010 provides options to deliver 15V, 12V, 9V and 5V power within the Low Voltage Enclosure . The PW1010 Module provides (6) Power Cord Jumper Wires for this purpose. The PW1010 is especially useful for making power connection to Data Networking Modules: Routers, Switches and Camera Modules.

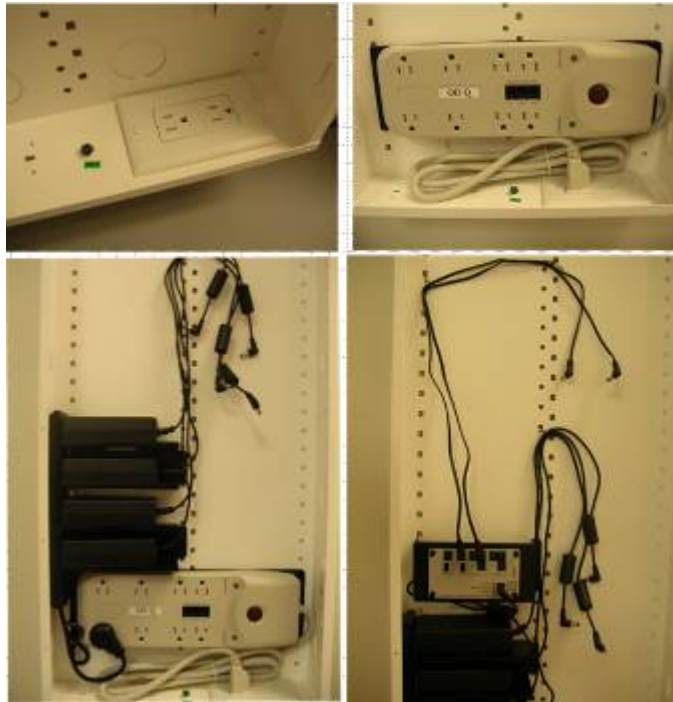

Low Voltage Enclosure Power Distribution Installation & Wiring Example

- iv. Now that the base AC to DC Power Subsystem has been established the remaining effort involves placement of the various Unity Integration Modules and connection of DC Power Cords from DC Supply Sources to the Modules.

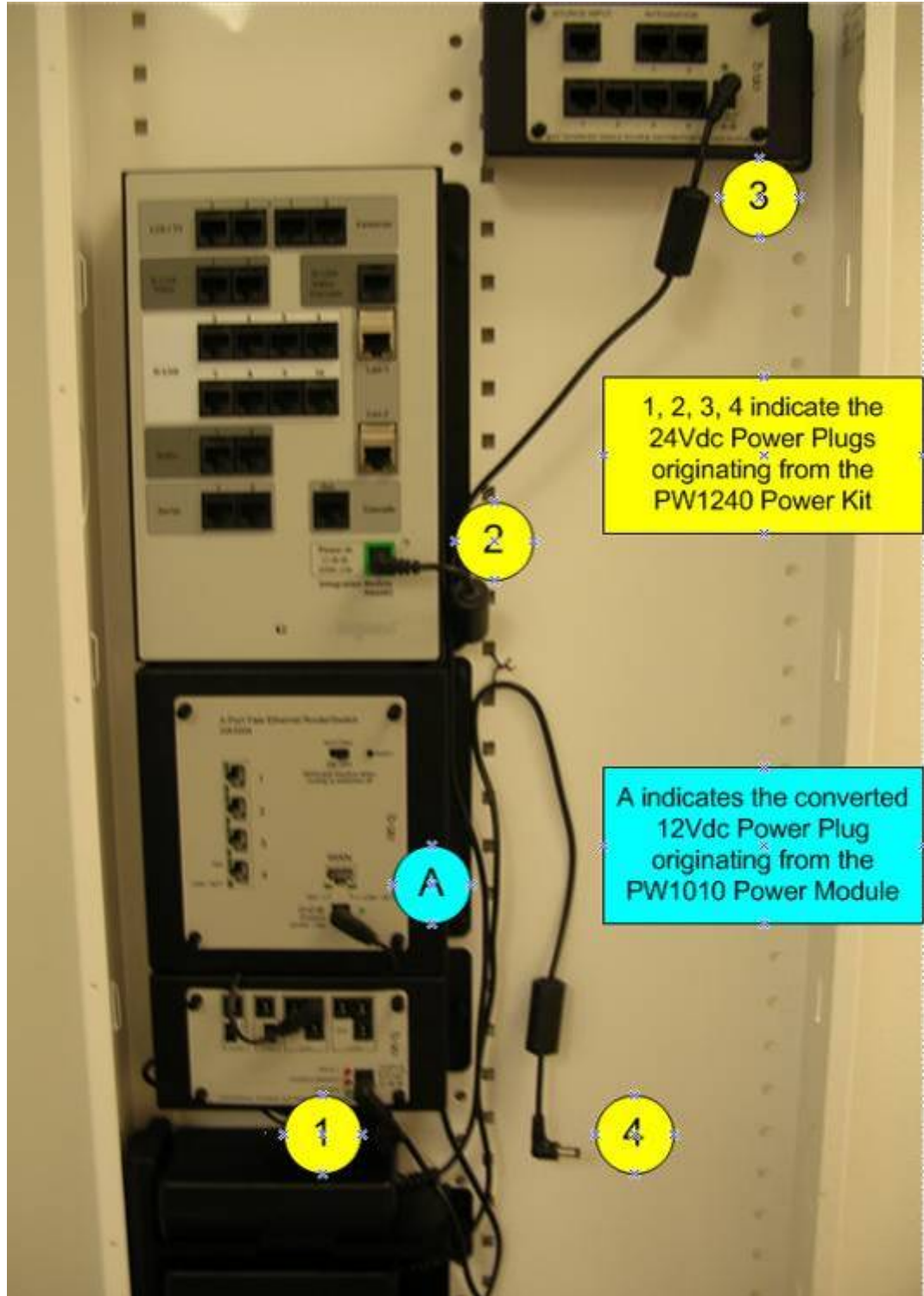

- v. Legrand recommends labeling the Power Supply and it's associated Power Plug for ease of recognition during and after complete installation.



- vi. Legrand offers a variety of other Power Distribution Products that may be used to complete a power distribution for any particular Unity Integration System configuration.
- 1) Legrand offers individual desktop style Power Supply Options to choose from, such as:
 - a) 24Vdc @ 30W, Model Number (PW1030).
 - b) 24Vdc @ 60W, Model Number (PW1060).
 - c) 12vdc @ 30W, Model Number (PW7725).



Single Desktop Style Power Supplies – Model Numbers (PW1030, PW1060, PW7725)

- 2) Legrand offers a second Power Supply Kit that includes only (2) 24Vdc @ 60W Power Supplies, (PW1120).



24Vdc 120W Power Supply Kit – Model Number (PW1120)

2. Unity System - Specific DC Power Requirements

a. Home Automation

- i. **HA6001** – Integration Module
 - 1) This module requires a single PW1060 Power Supply connection
- ii. **HA6101** – Integration Expansion Module
 - 1) This module requires a single PW1060 Power Supply connection

b. Data Distribution

- i. **DA1004** – Four-Port 10/100 Router/Switch
 - 1) This module requires a maximum of 4Watts of 12Vdc power.
 - 2) This can be accomplished using a single PW7725 or alternatively through the use of (1) of the 12Vdc power connections from a Universal Power Distribution Module (PW1010) powered from a single PW1060 Power Supply connection.
- ii. **DA1002** – Five-Port 10/100 Switch
 - 1) This module is only used to expand the Data Network Subsystem
 - 2) This module requires a maximum of 4Watts of 12Vdc power.
 - 3) This can be accomplished using a single PW7725 or alternatively through the use of (1) of the 12Vdc power connections from a Universal Power Distribution Module (PW1010).
- iii. **DA1008** – Eight-Port Gigabit Switch
 - 1) This module is only used to expand the Data Network Subsystem
 - 2) This module requires a maximum of 10 Watts of 12Vdc power.
 - 3) This can be accomplished using a single PW7725 or alternatively through the use of (1) of the 12Vdc power connections from a Universal Power Distribution Module (PW1010).

c. Audio Distribution

- i. **AU1014** – lyriQ Single Source Four-Zone Audio Distribution Module
 - 1) This module requires (1) single PW1060 Power Supply connection, when connected to remotely located Standard Performance lyriQ Keypad Volume Controls (AU5009-XX). Alternatively, a single PW1030 Power Supply can be used to power the AU1014 when all Zones are connected to remotely located High Performance lyriQ Keypad Volume Controls (AU5010-XX), because the Audio Keypads

are actually powered by the required High Performance Keypad Power Distribution Module, (AU1001).

- 2) Legrand offers a similar Single Source Distribution Module (AU7396), that is used only for cascading audio zones off of the AU1014. A single PW1060 connection is required for every cascaded AU7396 Audio Module used to power Standard Keypad Volume Controls. Alternatively, a single PW1030 Power Supply can be used to power the AU7396 module when all Zones are connected to remotely located High Performance lyriQ Keypad Volume Controls (AU5010-XX).
- ii. **AU1002** – lyriQ Four-Source, Eight-Zone Audio Distribution Module
 - 1) This module requires up to (2) single PW1060 Power Supply connections, when connected to remotely located Standard Performance lyriQ Keypad Volume Controls (AU5009-XX). One PW1060 powers Audio Keypads on Zones 1 thru 4, while the second PW1060 powers Audio Keypads on Zones 5 thru 8. A single PW1030 Power Supply can be used to power the Au1002 when all Zones are connected to remotely located High Performance lyriQ Keypad Volume Controls (AU5010-XX), because the Audio Keypads are actually powered by the required High Performance Keypad Power Distribution Module, (AU1001).
 - iii. **AU1023** – lyriQ Integration Capable Multi-Zone Expansion Module
 - 1) No Power Supply Connection is required for this Module
 - iv. **AU1001** – lyriQ High Performance Keypad Power Distribution Module
 - 1) This module requires up to (2) single PW1060 Power Supply connections. Each PW1060 drives (2) remotely located lyriQ High Performance Audio Keypad Volume Controls
- d. **Intercom Distribution**
- i. **IC5001** – Selective Call Intercom Eight-Location Distribution Module
 - 1) This Intercom module is only required to increase the number of Selective Call Intercom remote User Stations beyond the capacity of the Unity Integration Modules in the system.
 - 2) This module requires a single PW1030 Power Supply connection
- e. **Camera Video Distribution**
- i. **CM1010 & CM1011** – LCD Module and Category 5 Camera Module
 - 1) These modules are only required when it is desired to increase the number of Video Cameras beyond the capacity of the HA6001 Unity Integration Module, (2) Studio Ball Cameras (CM5002-XX) and (2) Video Door Stations (IC5003-XX).
 - 2) The CM1010 module requires a single PW1030 Power Supply, when configured in a Unity Integration System and a CM1011 Camera Module is being used to interface directly to the Video Cameras. The CM1011 requires 9.6 Watts of 12Vdc power which can be accomplished using a single PW7725 or alternatively through the use

of (1) of the 12Vdc power connections from a Universal Power Distribution Module (PW1010).

ii. **CM1048** – Combination Camera LCD Module

- 1) This module is required when it is desired to increase the number of unique Unity System Control User Interfaces beyond (2). This module also provides the ability to increase the number of Video Cameras beyond the capacity of the HA6001 Unity Integration Module, (2) Studio Ball Cameras (CM5002-XX) and (2) Video Door Stations (IC5003-XX).
- 2) When configured within an Unity integration Module System, the CM1048 module requires a single PW1060 Power Supply.

f. **Lighting Control**

i. **LC2354** – Unity RS232 Lighting Controller Kit

- 1) The module in the Kit requires 1 Watt of 9 to 12Vdc power.
- 2) This module ships with the required power supply.

g. **Heating Ventilation and Air Conditioning (HVAC) Control**

i. The Unity Integration System has the capability to integrate with HVAC Control Equipment.

- 1) It is required to contact the legrand Home Systems Technical Support Team for additional information on this capability.

2) Tech Support can be contacted by dialing 1-800-321-2343, automated attendant option number 1.

h. **Power Distribution**

i. **PW1010** – Universal Power Distribution Module

- 1) This module requires a single PW1060 Power Supply connection

E. Connecting the Network

1. LAN Connections – The HA6001 Integration Module requires (2) LAN connections to be made to a network routing device.

a. Legrand recommends the use of the Legrand DA1004 router to provide network connections to the DA1004.

i. For reference, the DA1004 Router default IP address for setup is 192.168.40.254

ii. **NOTE:** The HA6001 module will use DHCP – as such, it may be assigned a new IP address each time the DA1004 Router is power cycled. Static IP addressing of the HA6001 is not supported at this time.

b. **IMPORTANT:** The HA6001 module will not properly discover if both LAN connections are not made. Network activity lights on the HA6001 and router should be flashing, for both LAN connections, after powering the HA6001 module.

2. Internet Connectivity- An Internet connection will allow the HA6001 module to display Weather Information, Automatically set Date and Time, stream Internet Radio content, and perform System Software Updates.

a. An Internet connection is NOT required in order for the HA6001 module to function.

- b. The 364887-01 Wireless Access Point can be added to the system to allow wireless control of Lighting, Music, and Player, from a Laptop or Mobile device.

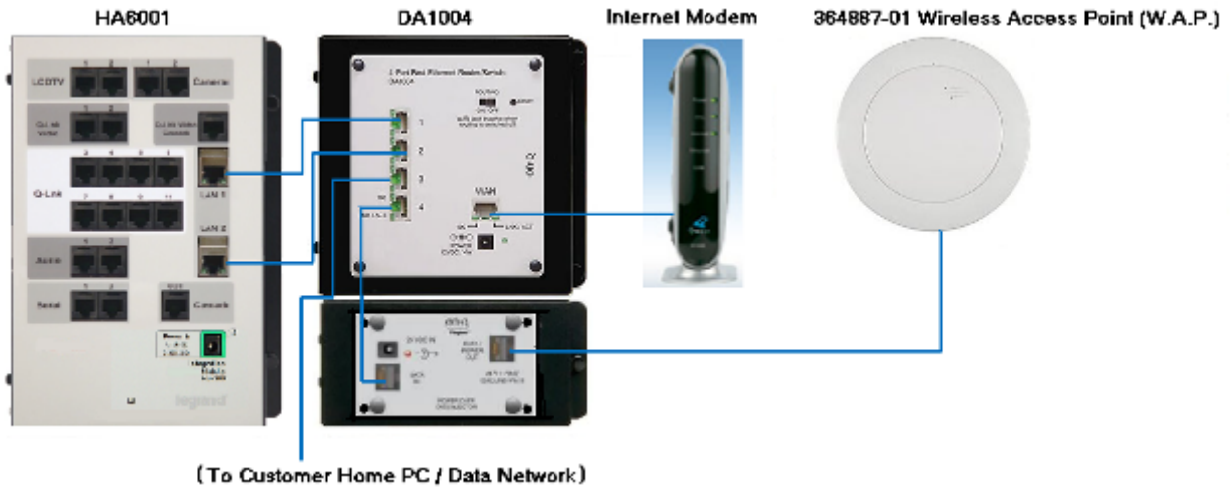

F. Connecting the lyriQ Audio System

1. Single Source (4) Zone

- a. AU1014 Advanced Single Source Module
 - i. This module requires two Cat5 cables to be connected from the HA6001 Integration Module Audio 1&2 ports, to the lyriQ Audio module's Integration 1&2 ports, as shown below.
 - 1) These connections provide the audio control and digital music from the HA6001, to the lyriQ system.
 - 2) This application is referred to as Single Source as there is only one Source input connected to the system. (Refer to AU1014 IS Sheet).
 - a) **NOTE:** In a Unity application, there are two Sources that each Zone may choose to listen too, the audio from the Source Input Unit [Source 1], or the digital music from the HA6001 [Source i].
 - ii. Refer to the IS sheet for the AU1014 for Power Supply, Source Input, and Audio Keypad connectivity.

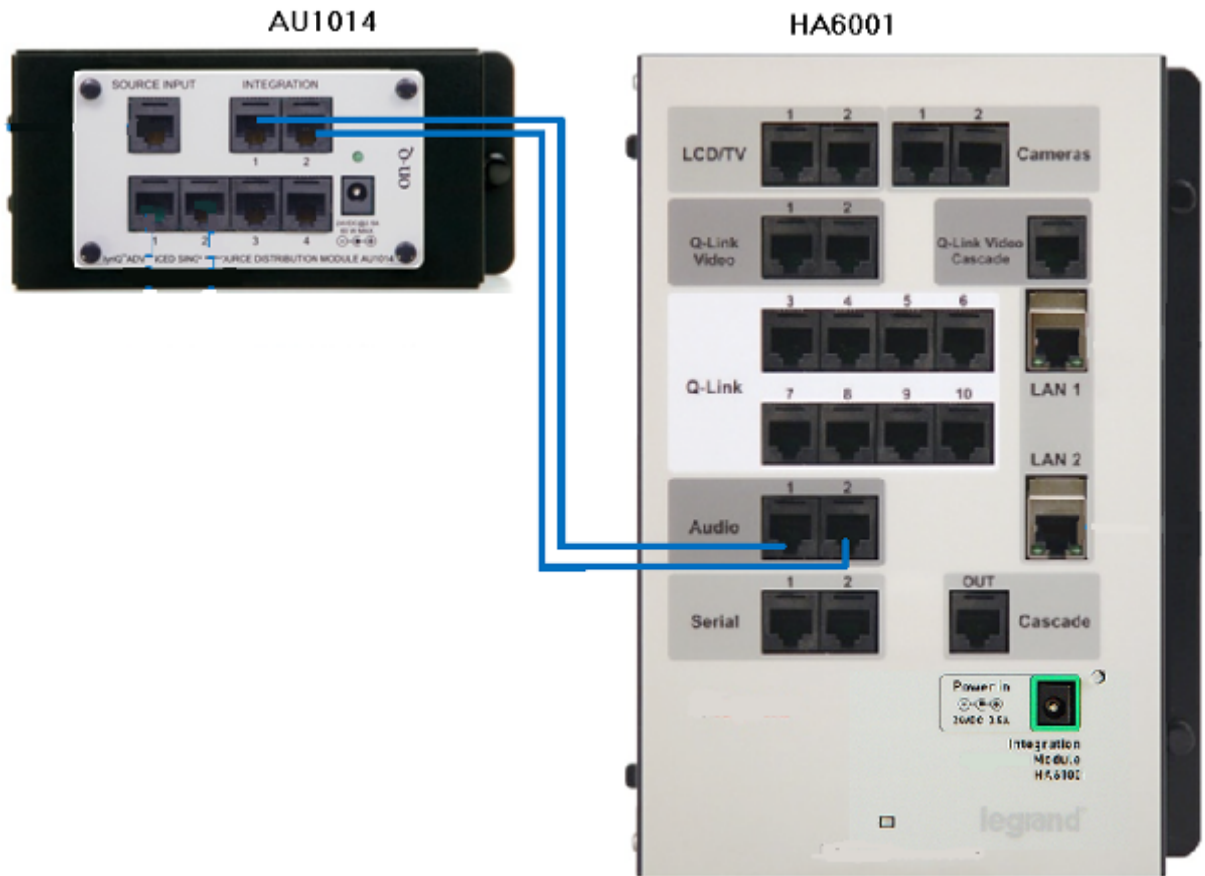

IyriQ Single Source 4 Zone

2. Multi Source (8) Zone

a. AU1002 4x8 Multi Source Module

- i. This module requires two Cat5 cables to be connected from the HA6001 Integration Module Audio 1&2 ports, to the IyriQ Audio module's Integration 1&2 ports, as shown below.
 - 1) These connections provide the audio control and digital music content from the HA6001, to the IyriQ system.
- ii. Refer to the IS sheet for the AU1002 for Power Supply, Source Input, and Audio Keypad connectivity.

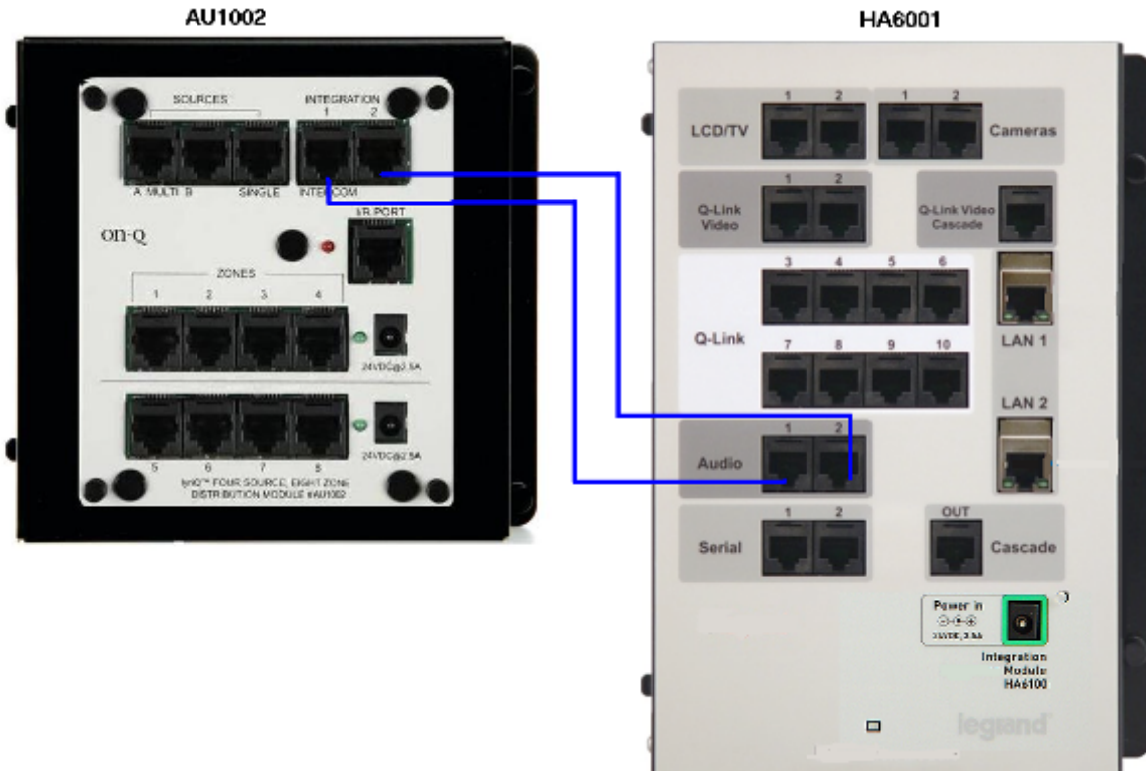

lyriQ Multi Source 8 Zone

3. Multi Source (16) Zone

- a. (2) AU1002 4x8 Multi Source Modules
 - i. When more than 8 independent Zones of audio are desired on a Unity System, two AU1002 modules, and an AU1023 Zone Expander module, are required to create up to 16 independent audio zones
- b. AU1023 Zone Expander
 - i. The lyriQ Source Input Units connect to the AU1023 Source Input ports labeled Multi A, B, and Single. This will pass the audio signals from the Source Inputs to each AU1002 Audio Module
 - ii. Five Cat 5 cables are connected between the AU1023 and each AU1002 audio module. These are Multi A, B, Single, Integration 1, and Integration 2. Connect each of the 5 cables to the corresponding ports on each respective AU1002 module as shown below.
 - iii. The AU1023 requires two Cat5 cables to be connected from the HA6001 Integration Module Audio 1&2 ports, to the ports labeled Integration Audio 1 and 2, on the AU1023.
 - 1) These connections provide the audio control and digital music content from the HA6001, to the lyriQ system
 - iv. Refer to the IS sheet for the AU1002 for Power Supply, Source Input, and Audio Keypad connectivity.

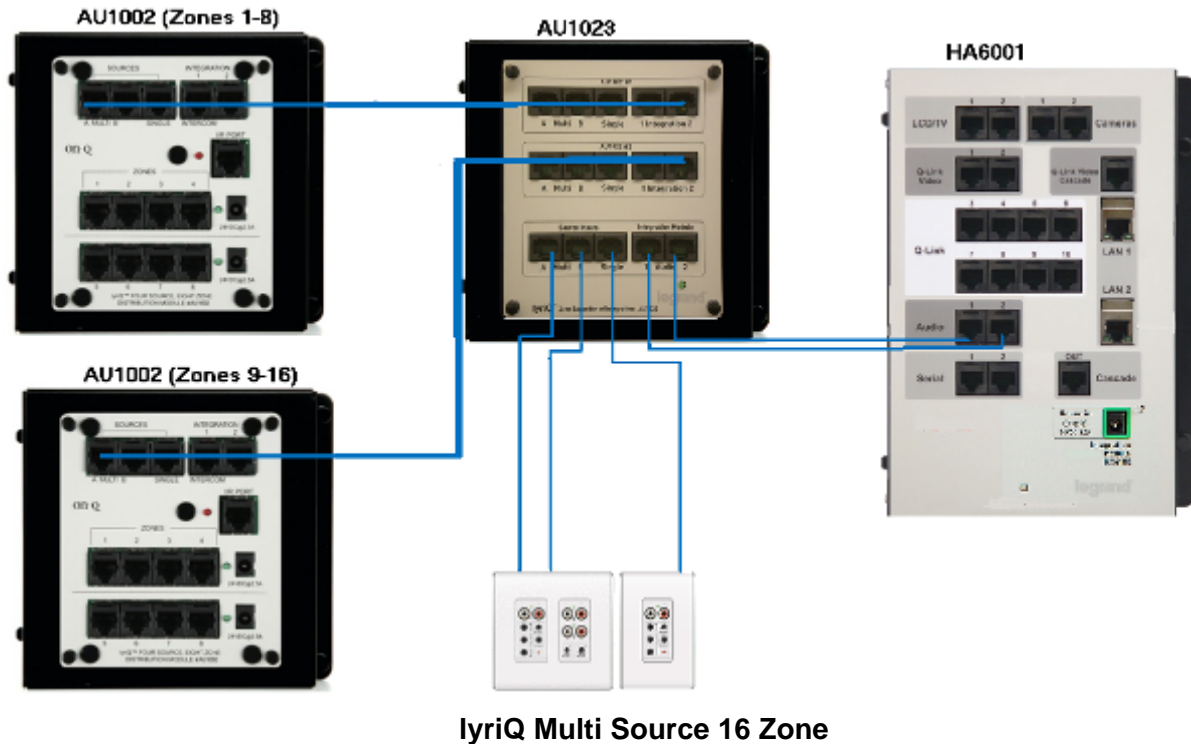

LyriQ Multi Source 16 Zone

4. LyriQ Zone Expansion (Cascade)

a. AU7396 as Zone Expansion Module

- i. The AU7396 Single Source Module can be connected to any Zone output of the LyriQ AU1014 (or AU1002), to allow up to four Audio Keypads to be connected to a single audio zone. The Zone output of the AU1014 (or AU1002) is connected to the Source Input on the AU7396 (per diagram below).
- ii. One AU7396 can be added to the each Zone of the AU1014 (or AU1002).
- iii. Keypads connected directly to the AU1014 (or AU1002) will act as an independent audio zone, that is, they can select an audio Source without impacting any other Keypad in the system.
- iv. Keypads connected to an AU7396 module will all play the same audio source selected for that zone (i.e. all four Keypads will listen to the same music).
 - 1) Each Keypad will have its own speakers, with independent Volume and On/Off control.
 - 2) This application is typically used in master suites/baths, great rooms, and large outdoor areas, where greater speaker coverage is desired.
 - 3) **NOTE:** One Keypad connected to the AU7396 must be assigned as a Group Master under the Keypads Installer Setup. This Keypad will report status to the HA6001 for the entire Zone.

- 4) **IMPORTANT:** All other Keypads connected to the same AU7396 must be assigned as Group Member under the Keypads installer setup. Failure to perform this change to each Keypad(s) will result in the Zone not being displayed on the HA6001 GUI (under Music).
- a) The HA6001 will only display the status of the Keypad chosen as Group Master for the Zone. Group members are not displayed in the HA6001 GUI (under Music).

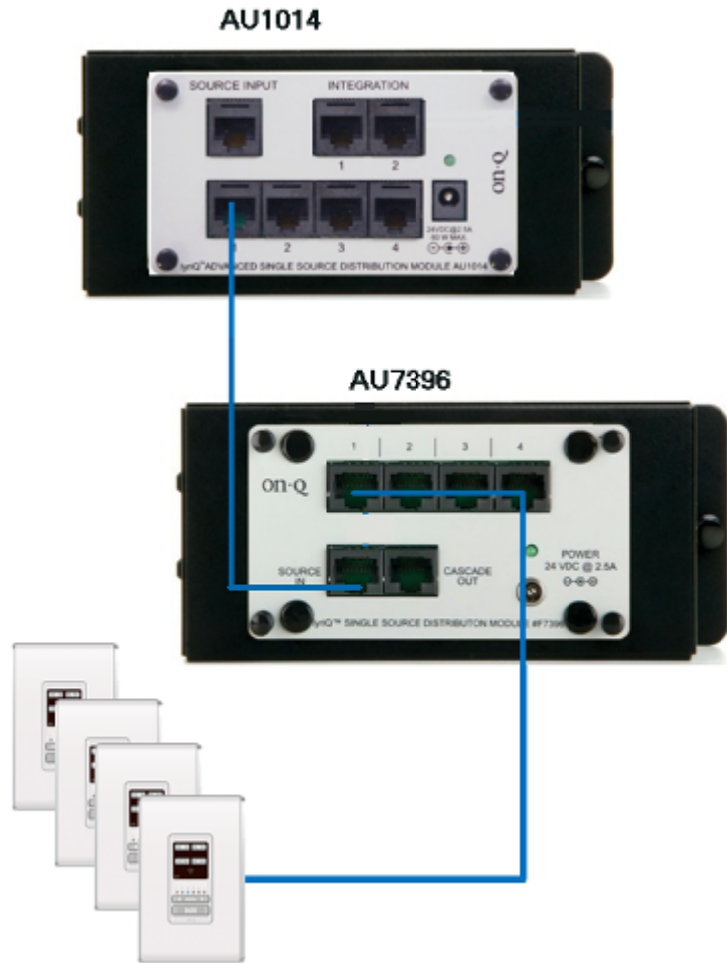

LyriQ Single Source Module Zone Cascade

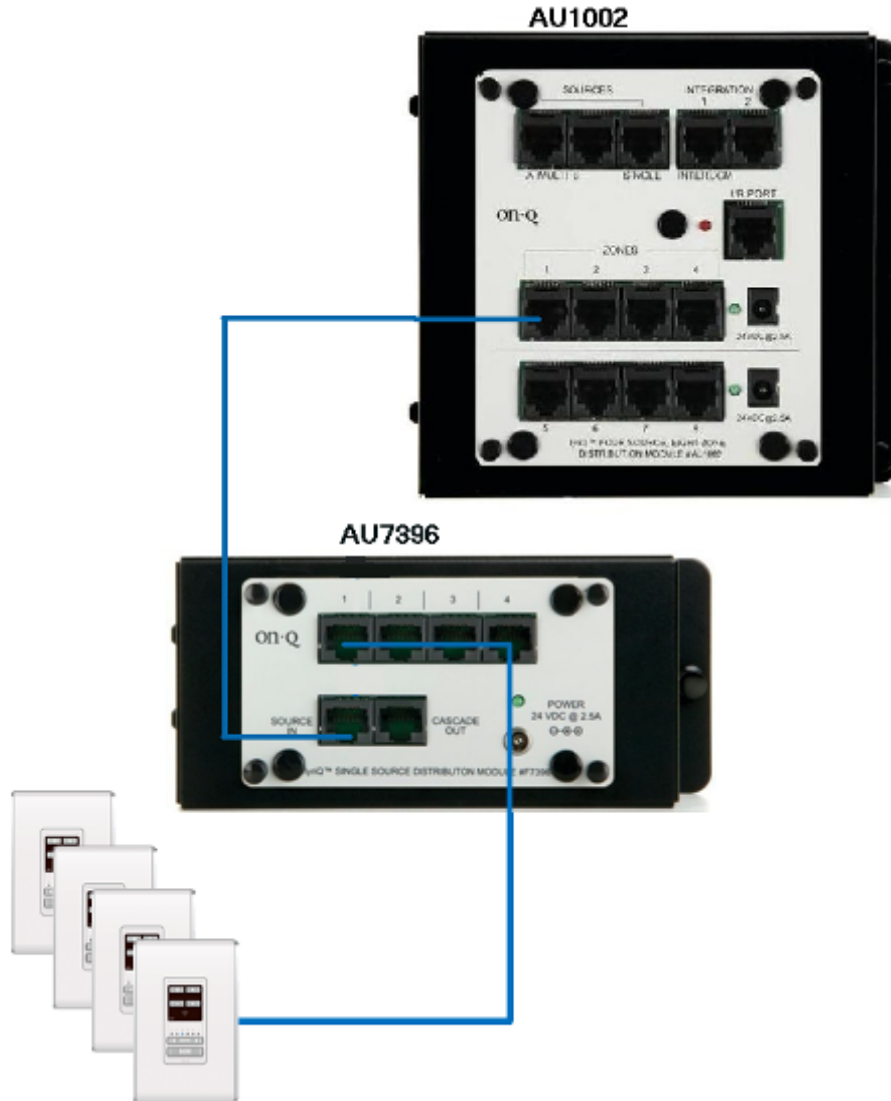

IyriQ Multi Source Module Zone Cascade

G. Connecting the Displays

1. HA5000 (7" LCD Display)

- a. The HA5000 requires a single Cat 5 run, from the LCD location, to the LCD/TV port on the HA6001.
- b. **NOTE:** A maximum of two LCD displays (HA5000, HA5009, or HA5010) can be connected to the HA6001 module. If more than two LCD's are desired in a system, the HA6101 Expansion module is required



HA5000 Connectivity

2. HA5009 (Display + built in lyriQ audio 7W/CH amplifier)

- a. Cat 5 - The HA5009 requires two Cat 5 runs, from the LCD location to the Low Voltage Panel.
 - i. Video Cat 5
 - 1) One of the two Cat 5 cables will connect to the rear of the LCD, on the bottom RJ45 connection. The other end of this cable will connect to the LCD/TV port on the HA6001. This cable delivers video, voice, and data to the LCD.
 - ii. Audio Cat 5
 - 1) The second Cat 5 cable will connect to the rear of the LCD, on the top RJ45 connector. This RJ45 will have a sticker to indicate it is for lyriQ audio. The other end of this cable will connect to the lyriQ audio module (AU1014 or AU1002). This cable delivers the analog music content to the LCD's internal lyriQ amplifier.
- b. Speakers - The HA5009 requires two 16/2 speaker wires runs from the LCD Location to Speaker Locations within the Room. The green speaker terminals are removable to ease installation.
 - i. The speakers are used to deliver music content from the lyriQ audio system. Sound control of the internal lyriQ amplifier is provided via the HA6001 G.U.I. (under Music).
 - ii. **NOTE:** Intercom audio is not delivered to these speakers.
 - iii. **IMPORTANT:** After connection of the HA5009, follow the Setup Instructions in this guide to assign the internal lyriQ amplifier to a lyriQ audio zone. This will provide additional control and functionality of this lyriQ amplifier.

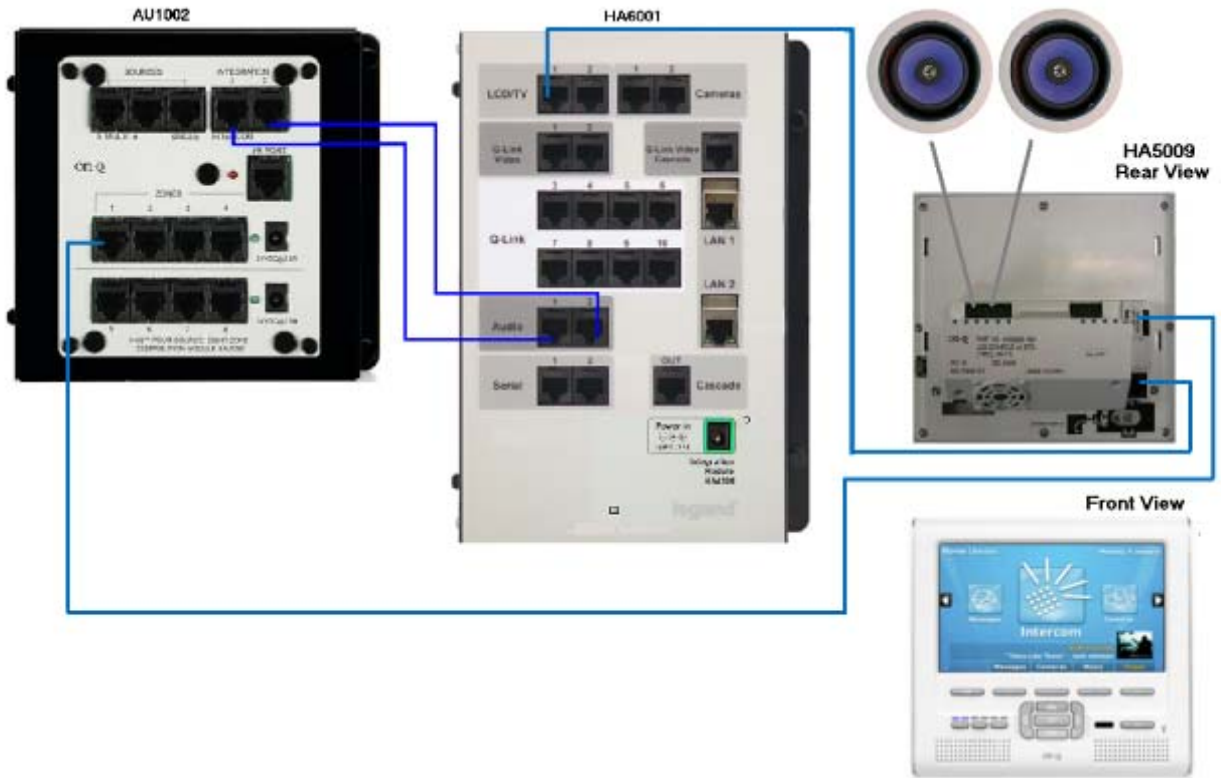

HA5009 Wiring (shown with AU1002 lyriQ Module)

3. HA5010 (Display + built in Hi Performance lyriQ audio 20W/CH Amplifier)

a. Cat 5 - The HA5010 requires two Cat 5 runs, from the LCD location to the Low Voltage Panel.

i. Video Cat 5

1) One of the two Cat 5 cables will connect to the rear of the LCD, on the bottom RJ45 connection. The other end of this cable will connect to the LCD/TV port on the HA6001. This cable delivers video, voice, and data to the LCD.

ii. Audio Cat 5

1) The second Cat 5 cable will connect to the rear of the LCD, on the top RJ45 connector. This RJ45 will have a sticker to indicate it is for lyriQ audio. The other end of this cable will connect to the lyriQ audio module (AU1014 or AU1002). This cable delivers the analog music content to the LCD's internal lyriQ amplifier.

b. Speaker - The HA5009 requires two 16/2 speaker wires runs from the LCD Location to Speaker Locations within the Room.

i. The speakers are used to deliver music content from the lyriQ audio system. Sound control of the internal lyriQ amplifier is provided via the HA6001 G.U.I. (under Music).

ii. **NOTE:** Intercom audio is not delivered to these speakers.

- iii. **IMPORTANT:** After connection of the HA5009, follow the Setup Instructions in this guide to assign the internal lyriQ amplifier to a lyriQ audio zone. This will provide additional control and functionality of this lyriQ amplifier.
- c. Power - The HA5010 requires a 16/4 speaker wire run from the LCD location to the AU1001 Power Module located inside the low voltage panel. This run provides the power needed for the 20Wx2 internal amplifier.

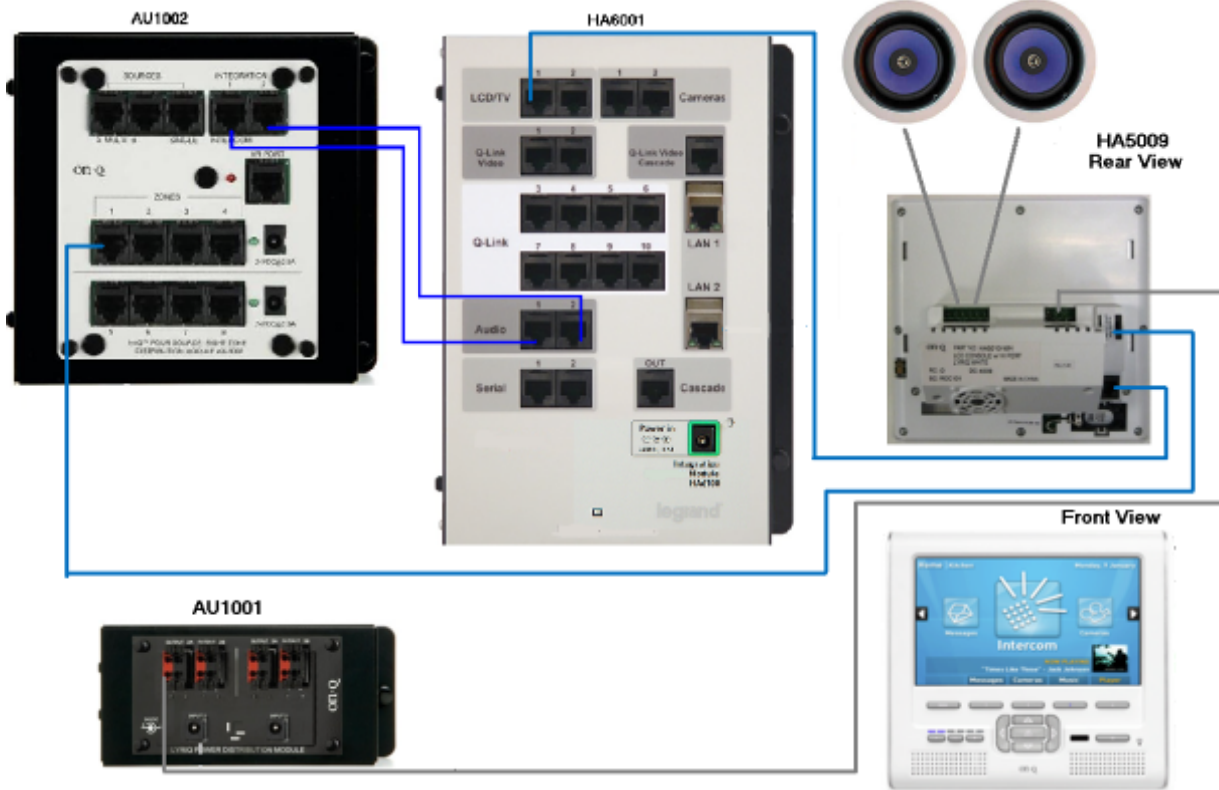

HA5010 Connectivity

4. TVDI (Television Display Interface)

a. Single Television (per GUI)

- i. In this application there is one HA5201 TVDI connected per LCD/TV port on the HA6001 module. A single Cat 5 cable must be ran from each TVDI location, to the HA6001 module.
- ii. The HA5201 can be used on the same HA6001 module as an LCD Console (HA5000/ HA5009/ HA5010). In this application, the LCD Console will connect to one of the LCD/TV ports, the HA5201 TVDI will connect to the other LCD/TV port.
- iii. The IR remote control target and Audio/Video RCA cables must reach from the HA5201 to the television. The supplied IR remote control target is 10 feet in length.
- iv. **NOTE:** The HA5201 TVDI does not support the use of Intercom from the Television. A HA5001 Selective Call Room Unit can be used to allow intercom in the same room as the HA5201.

- v. **NOTE:** The HA5201 TVDI does not allow for playback of Music from the Television. The lyriQ audio system is required in order to listen to digital music from the HA6001 module.
- vi. **NOTE:** It is not recommended to install two HA5201 TVDI (or one HA5201 and one LCD Console (HA5000/HA5009/HA5010)), in the same room. Both units will respond to IR commands, which may cause unexpected system behavior.

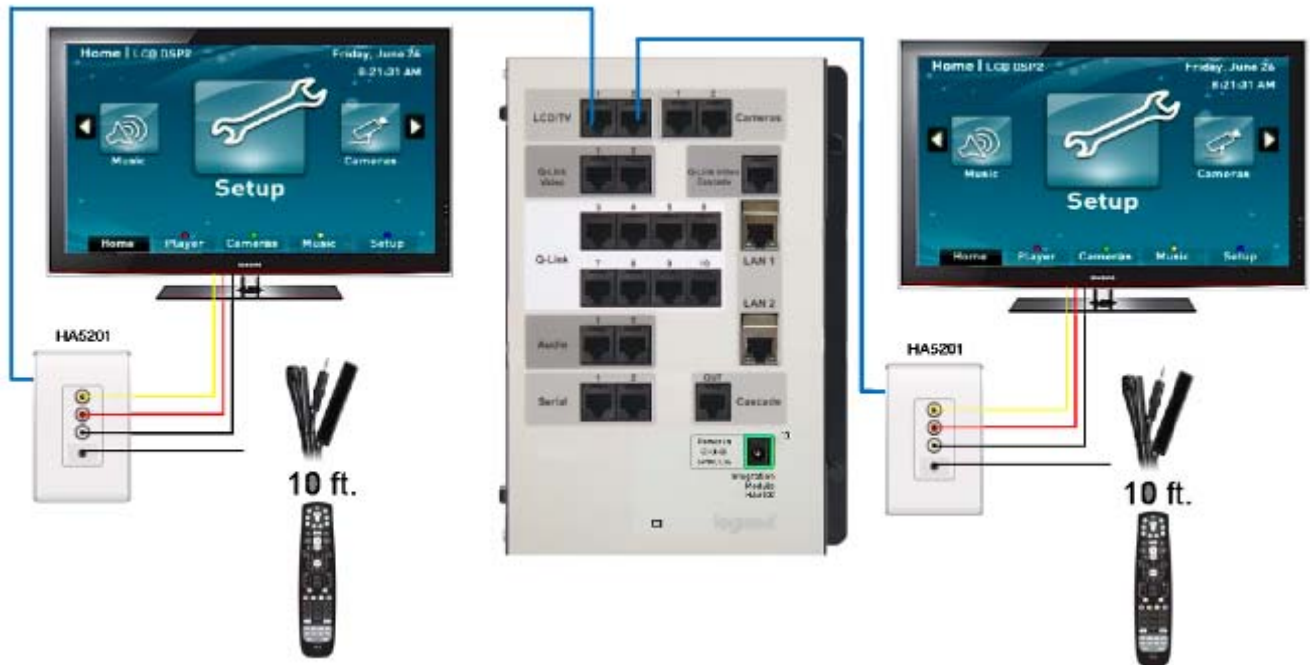

HA5201 TVDI Wiring (Single TV per GUI)

b. 4 Televisions (per GUI)

- i. HA5202 TVDI Expansion Module – The HA5202 will allow for up to (4) TVDI to be connected to one LCD/TV port on the HA6001.
NOTE: In this application, the same Graphic User Interface (G.U.I.) will be displayed on each TVDI that is connected to the HA5202 module. As there is no intercom functionality for the HA5201 TVDI, this poses no system limitation, but rather, allows more than two Televisions in the home to view cameras, control the audio, lighting, and all other features of the Unity system.
- ii. In this application there is one HA5202 TVDI connected per LCD/TV port on the HA6001 module. A single Cat 5 cable is connected between the HA5202 Input and the LCD/TV port on the HA6001 module.
- iii. A single Cat 5 cable will be ran from each HA5201 TVDI unit to the HA5202 TVDI Expansion Module(s) in the low voltage enclosure.

- iv. The HA5202 module can be used on the same HA6001 module as an LCD Console (HA5000/ HA5009/ HA5010). In this application, the LCD Console will connect to one of the LCD/TV ports, the HA5202 TVDI will connect to the other LCD/TV port.
- v. Two HA5202 modules can be used on the same HA6001, each connected to one of the LCD/TV ports.

NOTE: An external 24V power supply is NOT required when one HA5202 is connected per LCD/TV display port (i.e.4 TV per GUI application).

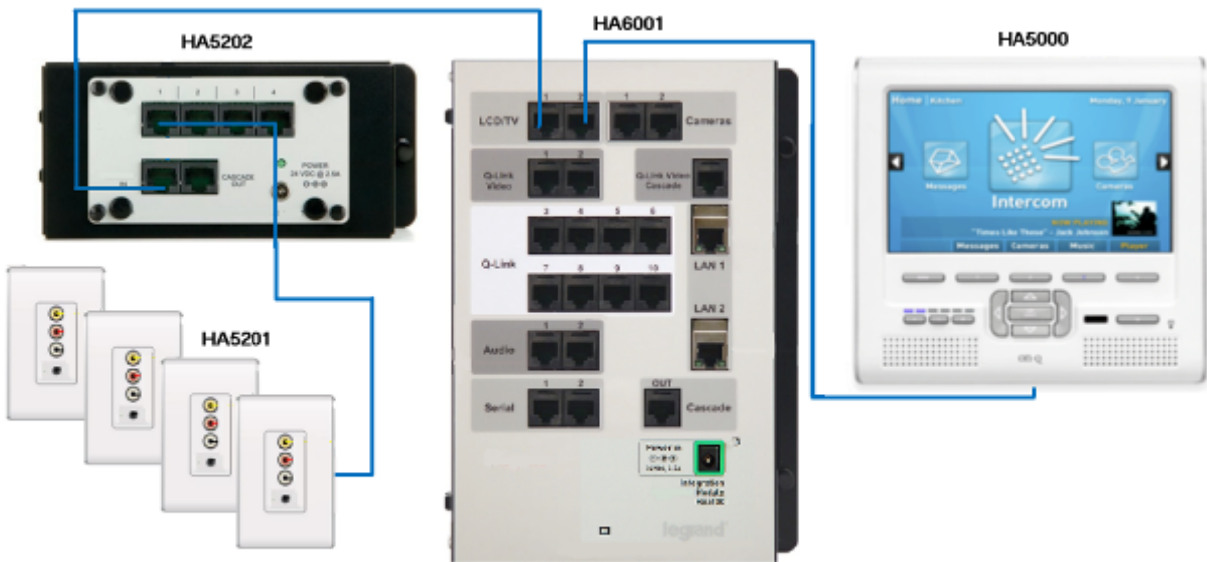

HA5202 TVDI Expansion Module Wiring (4 Televisions per GUI)

c. 8 Televisions (per GUI)

- i. (2) HA5202 TVDI Expansion Modules – Using two HA5202 TVDI expansion modules in a cascade configuration will allow for up to (8) TVDI to be connected to one LCD/TV port on the HA6001.

1) NOTE: In this application, the same Graphic User Interface (G.U.I.) will be displayed on each TVDI that is connected to the cascaded HA5202 modules. As there is no intercom functionality for the HA5201 TVDI, this poses no system limitation, but rather, allows more than two Televisions in the home to view cameras, control the audio, lighting, and all other features of the Unity system.

- ii. In this application there is two HA5202 modules connected per LCD/TV port on the HA6001 module. A single Cat 5 cable is connected between the first HA5202 modules input, and the LCD/TV port on the HA6001 module. The cascade out port on the first this HA5202 module will connect via a Cat 5 cable to the input port on the second HA5202 module.
- iii. A single Cat 5 cable will be required from each HA5201 TVDI units, to the HA5202 modules, in the low voltage enclosure.

- iv. By cascading, a maximum of two HA5202 modules can be used per HA6001 LCD/TV port (8 Televisions per GUI). This will allow for a maximum 16 Televisions to be connected to the HA6001 module.
 - 1) In this scenario, there is still only two Unique GUI's available (one per LCD/TV port).
- v. **IMPORTANT:** An external 24V power supply IS required with the HA5202 cascade. This power supply MUST be connected to the second HA5202 module in the cascade.

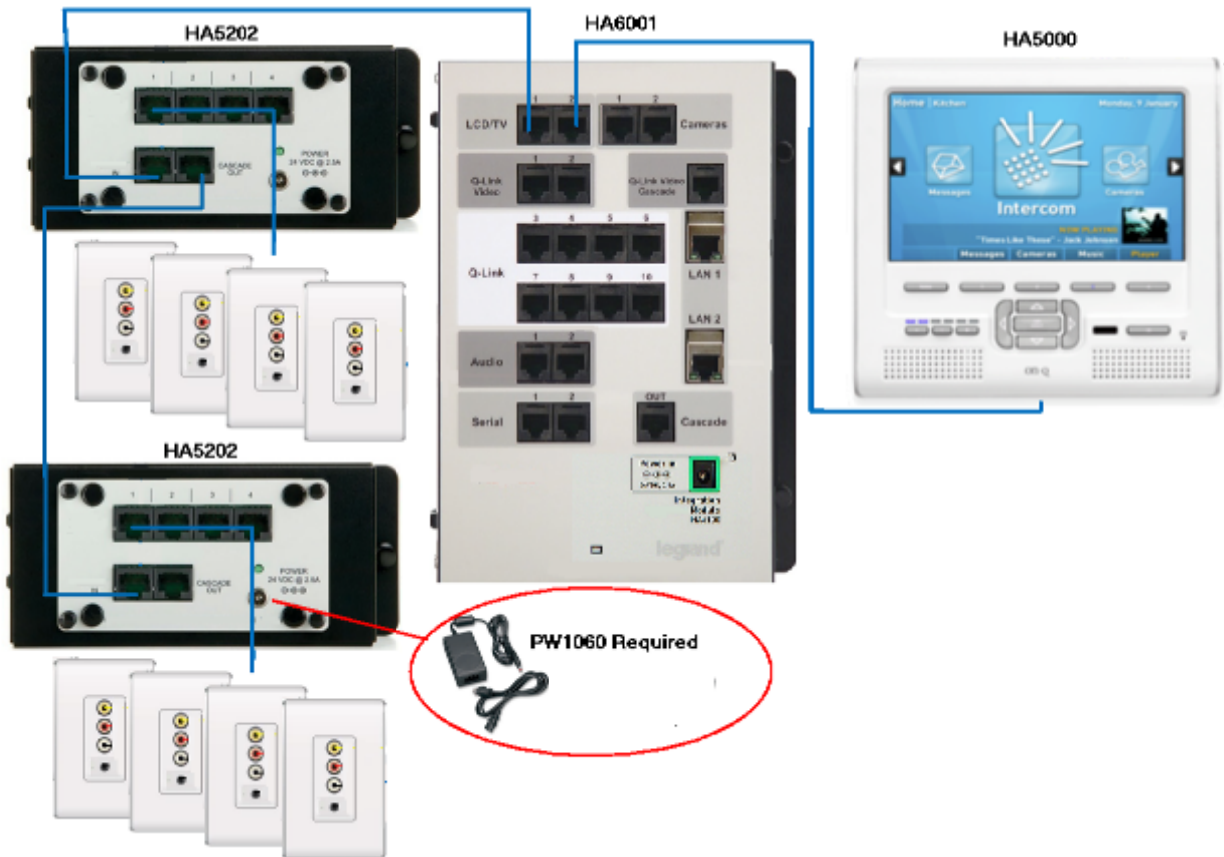

HA5202 Module Cascade (8 Televisions per GUI)

H. Connecting the Cameras

1. 2 Cameras

- a. CM5002 Ball Cameras only – In this application a single Cat5 cable is ran from each CM5002 Camera to one of the Camera ports on the HA6001 module.
 - i. **IMPORTANT:** The CM5002 is the only Legrand camera that can be connected directly to the Camera ports on the HA6001. If other cameras are desired, refer to 4 camera applications listed below.
 - ii. In this configuration, Camera 1 and 2 will appear as Camera 1 and Camera 2 when viewed from the HA6001 G.U.I. (under Cameras). Video Door Inputs (Q-Link Video 1 and 2) will appear as cameras 3 and 4 from the HA6001 G.U.I.

- 1) Audio – An optional microphone (CM1026) can be installed onto the camera to allow audio from the cameras location to be heard from the HA6001 G.U.I. (LCD Console or TVDI) when viewing the Camera.

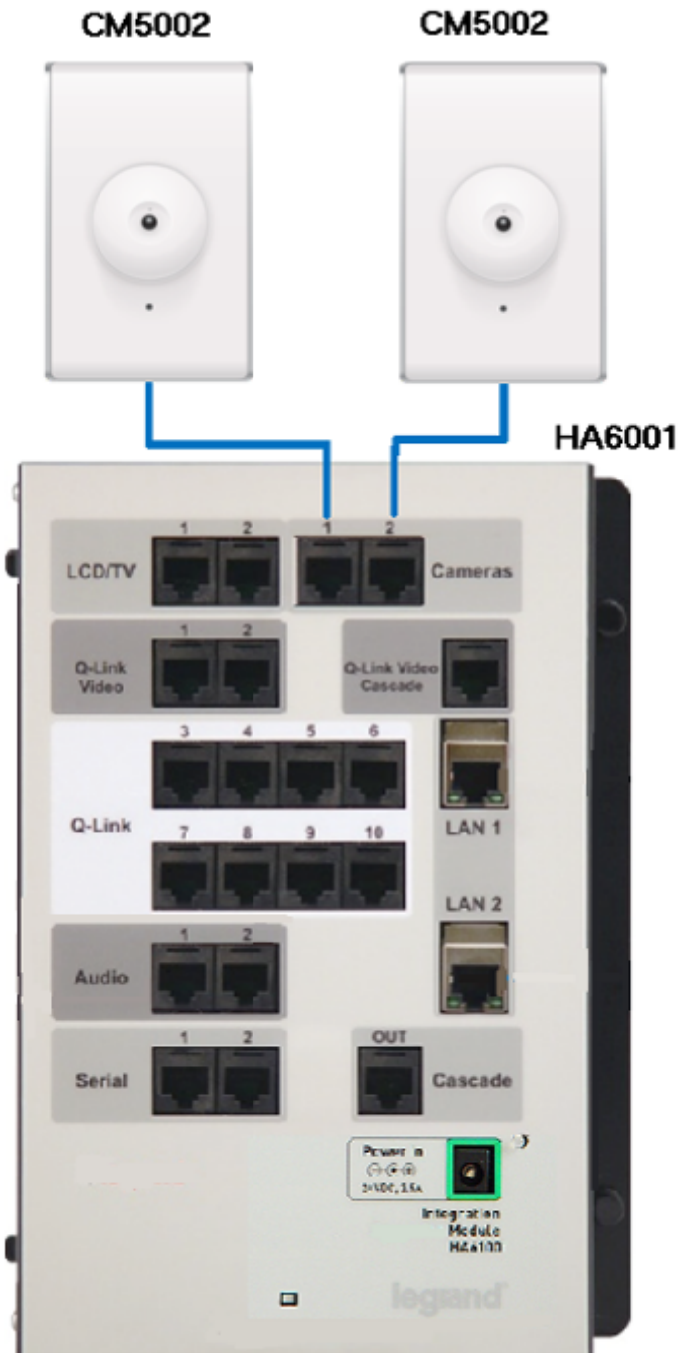

2 Camera (CM5002 Ball Cameras only) Wiring

2. 4 Cameras
 - a. Legrand Brand Cameras (All Models)

- i. CM1011 Camera Module – This module is used to connect any Legrand camera to the Unity system. A single Cat 5 cable will need to be run from each Camera location to the CM1011 module. This module will output the camera video and audio (if applicable) via the RCA ports located below each RJ45 port.
 - 1) **NOTE:** Only Legrand brand Cameras are compatible with this module.
 - 2) **NOTE:** The CM1011 module requires minimum 12V 1A power supply. Use of the PW7725 12V supply, or PW1010 Universal Power Distribution Module, is recommended.
- ii. CM1010 LCD Module – This module is used to connect the output of the CM1011 camera module to the HA6001 module to allow all Legrand brand cameras to be used with the Unity system. Two Cat 5 cables will be ran from the CM1010 module to the HA6001 module to provide the camera audio/video signals.
 - 1) Connect one Cat 5 cable from CM1010 Port 1 to Camera Port 1 of the HA6001
 - 2) Connect a second Cat 5 cable from CM1010 Port 2 to Camera Port 2 of the HA6001
 - 3) Connect Yellow (CM1017) RCA patch cable between the CM1011 and CM1010 modules for video input
 - 4) Connect White (CM1018) RCA patch cable between CM1011 and CM1010 modules for audio input (if applicable)
 - 5) **NOTE:** External 24V power supply for the CM1010 is not required in this application
- iii. In this configuration, Camera 1 through Camera 4, connected to the CM1011 module, will appear as Camera 1 through Camera 4 when viewed from the HA6001 G.U.I. (under Cameras). Video Door Units (Qlink Video 1 and 2) will appears as camera 5 and camera 6.
- iv. **NOTE:** Today monitoring of Cameras from outside the home requires the use of CM1019 IP Video Server. Refer to the following solution for system wiring requirements for the CM1019.
<http://www.legrand.us/Residential/Camera-Solutions/Ultimate-Camera-Solution.aspx>

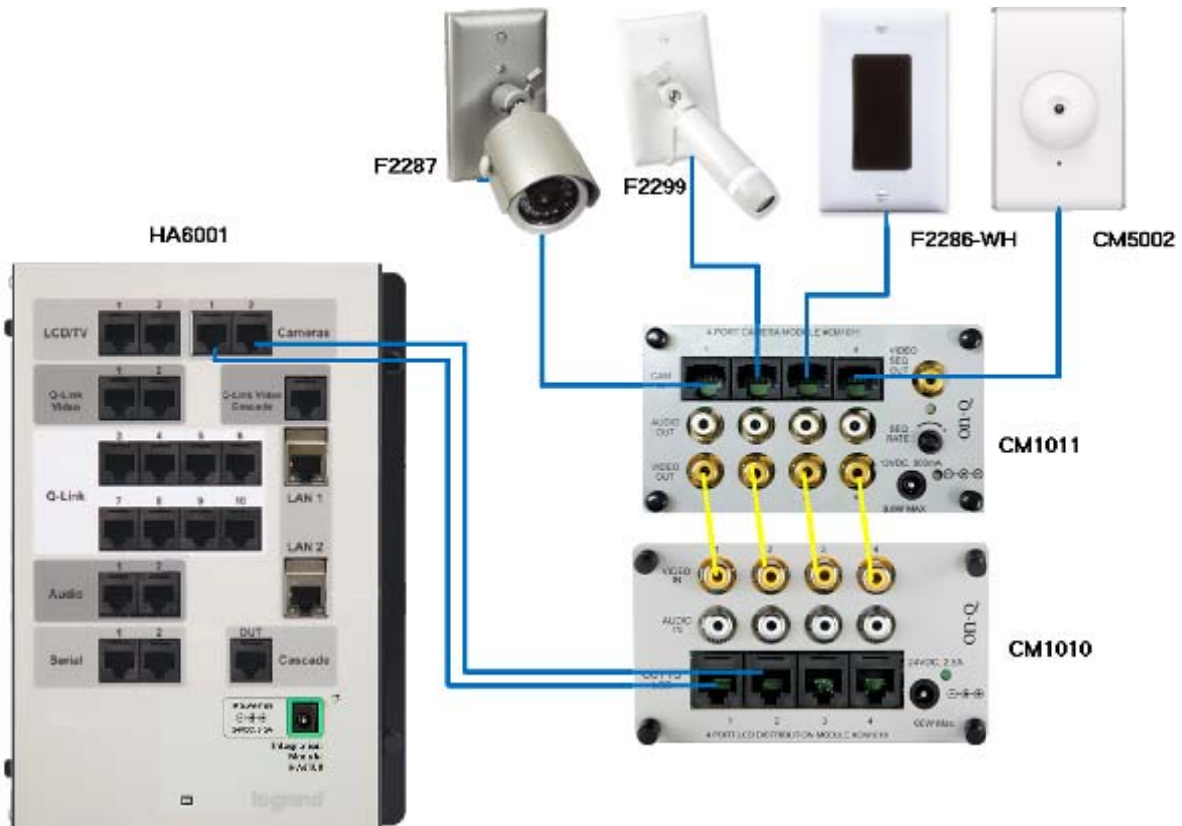

4 Camera (Legrand Brand only) Wiring

b. 3rd Party Cameras

- i. This application is identical to the 4 Camera Legrand Brand only wiring found above. However in this application, a 3rd party camera is connected to the Unity system via the CM1010 module.

1) **NOTE:** 3rd Party camera must have standard NTSC composite video output (un-modulated).

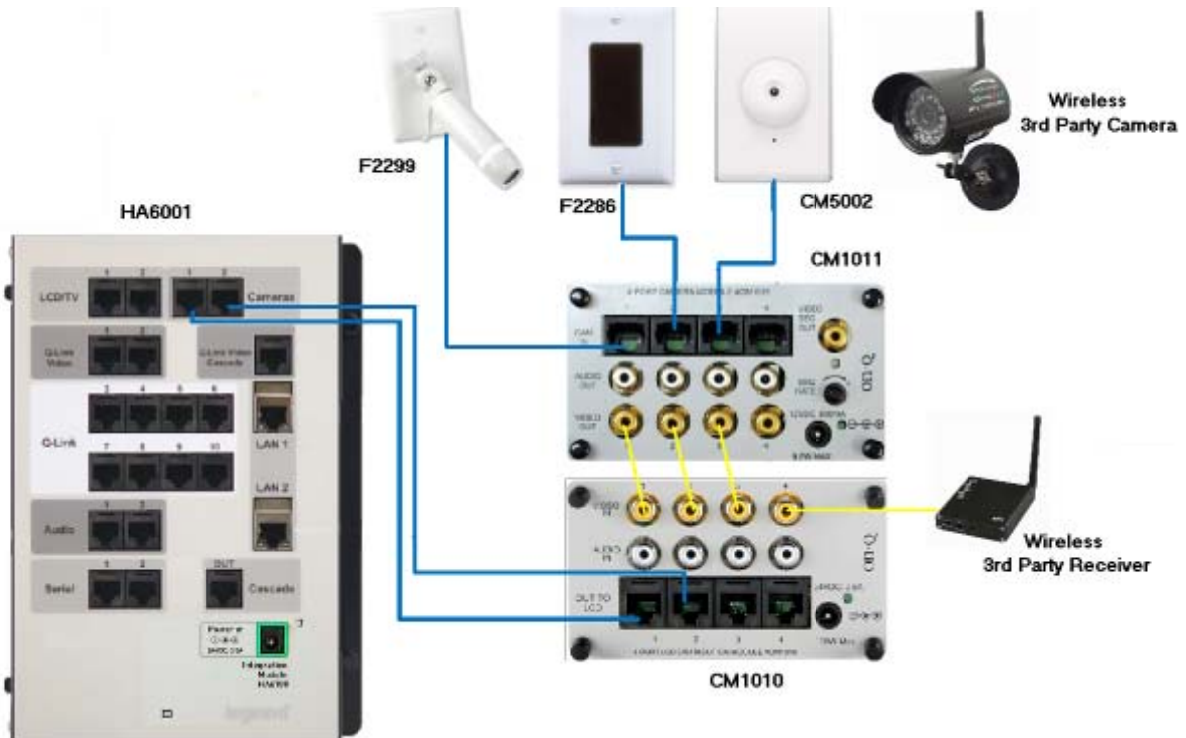

3rd Party Camera Wiring

I. Connecting the Video Doors

1. IC5003 Video Door Units – Two IC5003 Video Door Units can be connected to the HA6001 module. A single Cat 5 cable is ran from each IC5003 location, to the HA6001 module's Q-Link Video 1 or Q-Link Video 2 ports.
 - a. The video from the IC5003 can be viewed by selecting Cameras from the HA6001 G.U.I. (LCD Console or TVDI)
 - i. In a 2 Camera system, Q-link Video 1 will appear as Camera 3, Q-link Video 2 will appear as Camera 4.
 - ii. In a 4 Camera system, Q-link Video 1 will appear as Camera 5, Q-link Video 2 will appear as Camera 6.
 - b. The video from the IC5003 will be displayed on the LCD Console when the unit is selected (under Intercom).
 - i. **NOTE:** Audio from the IC5003 can only be heard when it is involved in an intercom conversation. The IC5003 will allow video monitoring from the HA6001 (under Cameras), however audio monitoring is not supported.
 - 1) A Legrand camera (CM5002) with optional mic (CM1026) is required for audio and video monitoring.
 - c. The video from the IC5003 will automatically be displayed on LCD Consoles (under Intercom) and the TVDI (under Cameras), when a Door Bell is pressed.

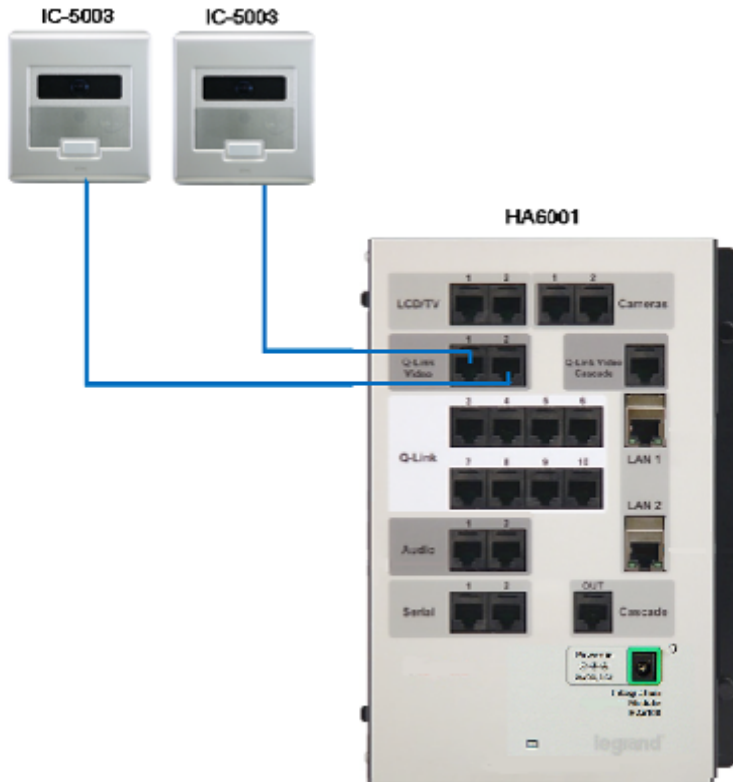

J. Connecting the Intercom Units

1. **Selective Call Intercom** – (8) IC5000 (Room Units), IC5002 (Door Units), or IC5004 (Patio Units), or any combination of these units, can be connected to Q-Link ports 3 through 10 on the HA6001. A single Cat 5 cable is required from each unit to the Q-Link port on the HA6001 module.

IMPORTANT: A maximum of 32 Intercom Units are allowed in a Unity system. This includes LCD Consoles (HA5000/HA5009/HA5010), Video Door Units (IC5003), Door Units (IC5002), Room Units (IC5000), and Patio Units (IC5004).

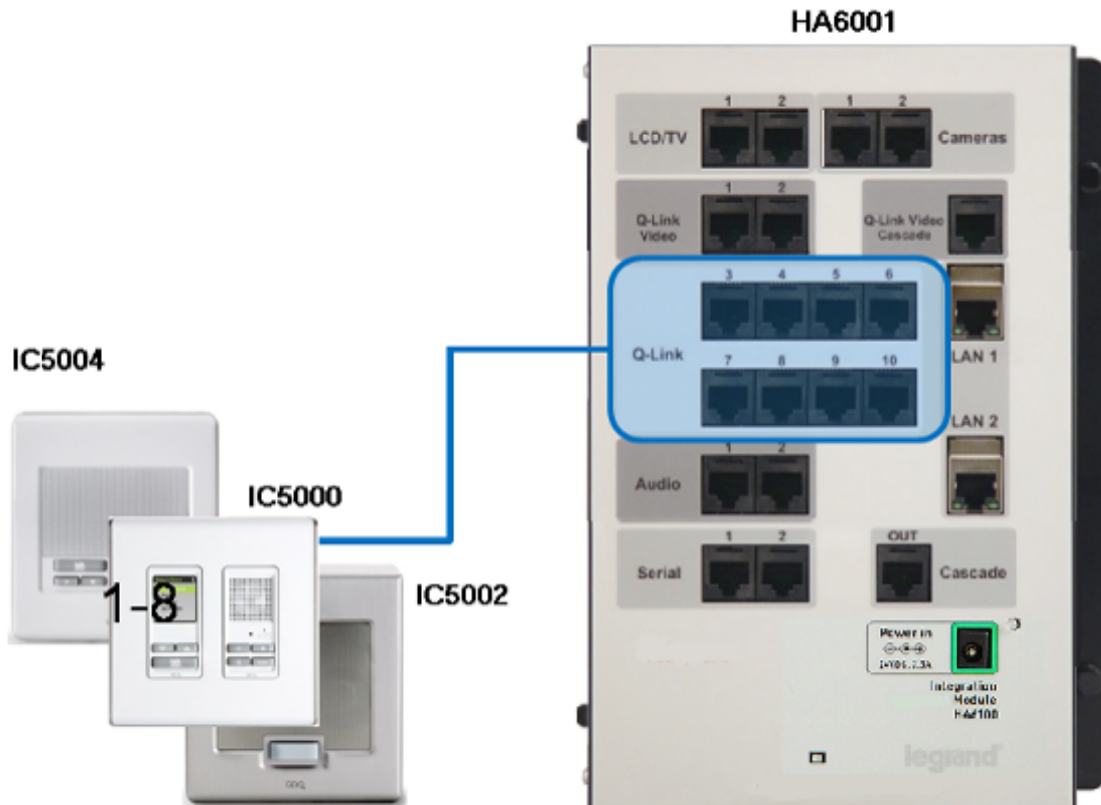

Selective Call Intercom Unit Wiring

2. Intercom Expansion

- a. IC5001 Cascade – The IC5001 Selective Call Intercom module can be used to add additional intercom units to the Unity system. This requires a single Cat 5 cable connected from the Cascade IN port on the IC5001 to the Cascade OUT port on the HA6001.
 - i. A maximum of 3 IC5001 Modules can be connected to the HA6001 module for cascading. Each IC5001 Cascade IN port will connect to the previous IC5001 Cascade OUT port with a single Cat 5 cable. Each IC5001 will allow up to 8 additional Room (IC5000), Door (IC50020, or Patio (IC5004) units, up to the maximum limit of 32 units per system .
 - ii. **IMPORTANT:** Jumper settings on the rear of the IC5001 must be configured correctly in order for the system to discover all intercom units properly. Please observe the jumper setting for each module in the cascade as shown in the diagram below.

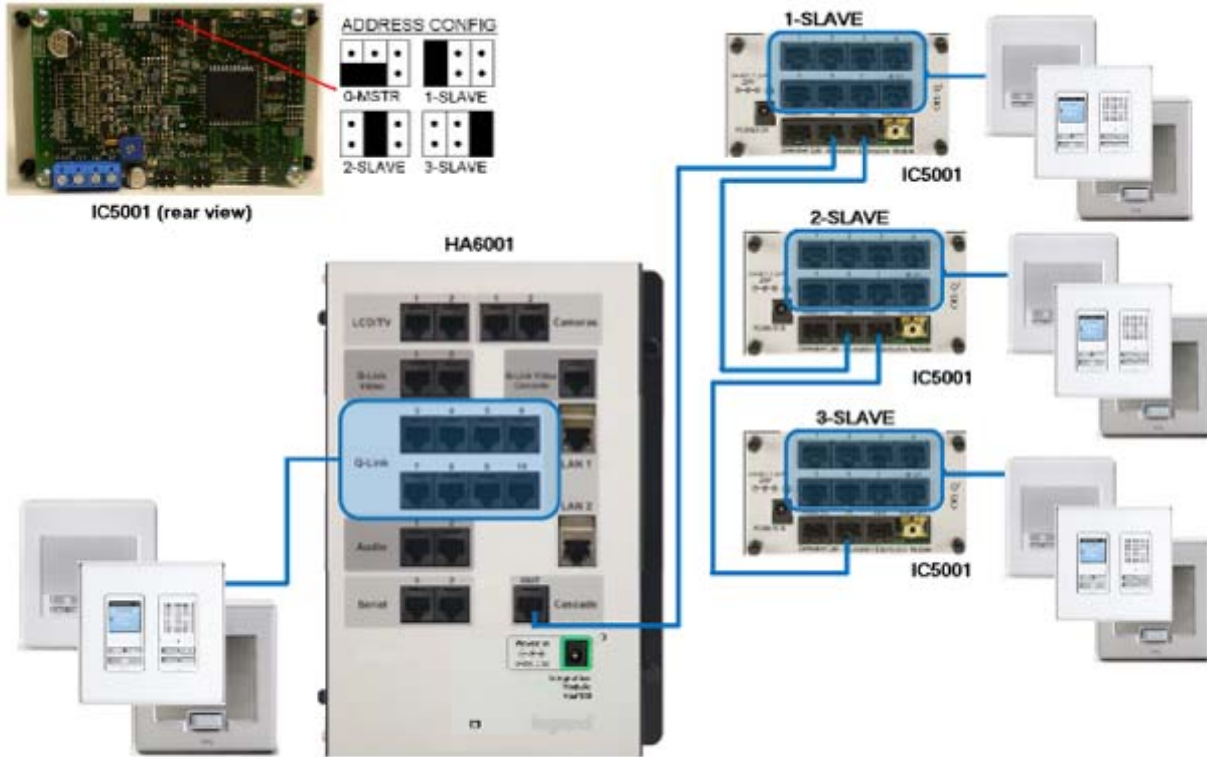

K. Connecting Legrand Radio Frequency Lighting Control (RFLC)

1. LC2354 Kit is required to connect the Legrand RFLC System to the HA6001 module. A single Cat 5 cable will be ran from the LC2354 location, to the Serial 1 port on the HA6001 module.
 - a. It is recommended that the LC2354 Kit be mounted outside of the low voltage panel for maximum reception performance. It is best if this location is also central to all Lighting Control Devices in the home.
 - b. The MR232 (included in the LC2354 Kit) must be bound to the same house as all other RFLC devices that are to be controlled from the HA6001 G.U.I. (LCD Console or TVDI). Following the instructions for binding included with the RFLC devices.
 - i. **IMPORTANT:** All RFLC House and Group binding should be performed before powering the HA6001 module.
 - 1) A four digit address (under Lighting) will appear for each device found by the Unity system.
 - 2) Unity will only display one 4 digit address for an RFLC Group (no matter how many devices are bound within the Group).
 - ii. **NOTE:** RFLC Dimmers, Switches, and Fan Speed Controllers are the only devices that will be discovered and controlled from the Unity system. RFLC Scene Controllers are not displayed on Unity.
 - 1) Creating scenes from the RFLC Scene Controller devices can be performed at any time.

- a) Scenes created from RFLC Scene Controllers are not accessible from the Unity system.
 - 2) Lighting scenes, independent of those in the RFLC Scene Controllers, can be created within the Unity system. This allows for simplified setup, and advanced usability, as Light scenes created within Unity can be triggered manually from a G.U.I. (LCD or TVDI), or based on Date and Time, Sunrise, or Sunset, through the use of the Unity system EVENTS.
- iii. **NOTE:** It is possible to discover RFLC devices without powering down the HA6001 module. This can be done from the HA6001 G.U.I. (LCD or TVDI) by going to Setup-Lighting and selecting “RF-Scan”.
- 1) RFLC devices previously found by the HA6001 module will not be removed from the HA6001 G.U.I. (under Lighting), even if the device has been removed from the Lighting control system. RFLC devices must be removed manually from the HA6001 G.U.I. (LCD or TVDI) by going to Setup-Lighting-Zones and selecting “Delete”.
 - 2) Activating a Lighting Device (bound to the MR232) will also cause it to be found by the Unity system. This may be useful if an RF-Scan does show all device addresses bound to the MR232.
- iv. **IMPORTANT:** Addresses that appear on the Unity system, but do not control any Lighting device in the home, are often the result of Group binding that occurred after the HA6001 was powered on. It is advised to Delete these addresses and perform an RF Scan to remove these devices, as they are no longer valid addresses to the Unity system.

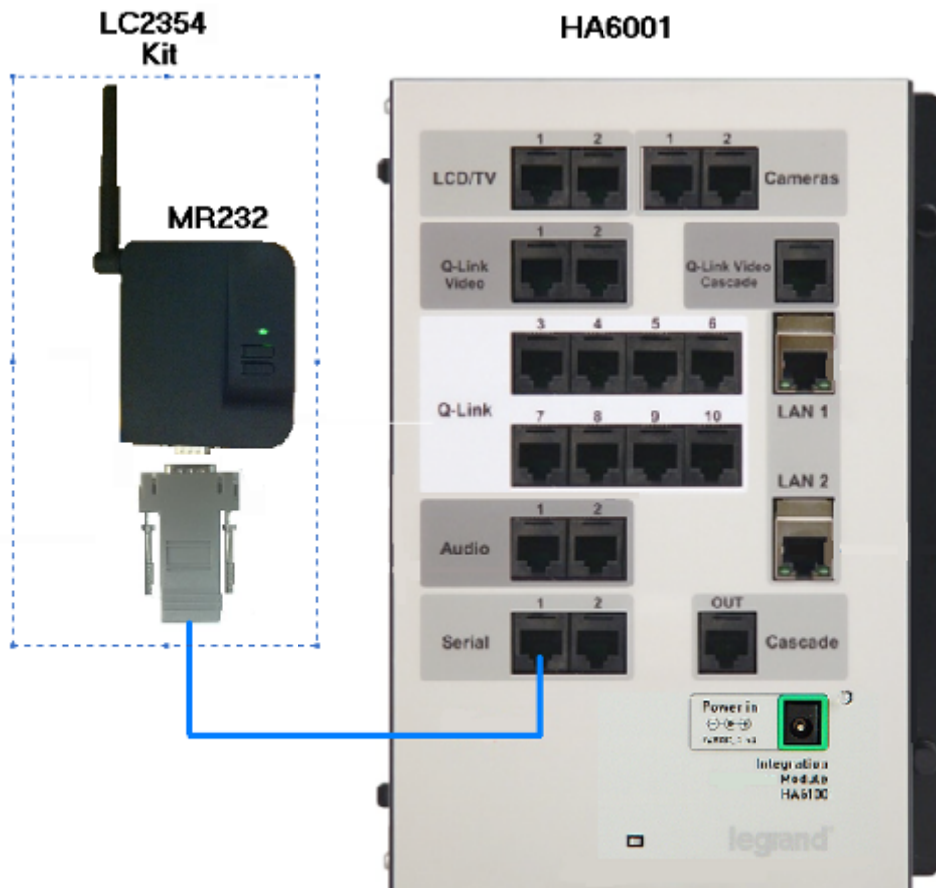

- L. Connecting an HVAC Controller** – Today the Unity system is designed to interface with RCS Brand TR60 Thermostats. This interface (known as Thermostats under the G.U.I.) is available via the LCD Console and TVDI. Users can view Inside/Outside temperatures, adjust Room temperatures (change Hot/Cold set points), and program Schedules.
1. Up to (3) TR60 thermostats can be displayed and controlled from Unity.
 - a. **NOTE:** Today thermostats cannot be viewed/controlled from the Internet
 2. Outside temperature will be displayed on the TR60 LCD when an Internet connection is provided to the HA6001 modules Data network.
 3. Please contact Technical Support (see contact info below) for information regarding setting up the TR60 Thermostats on a Unity system.
 - a. **NOTE:** Special Hardware (RS232 – 485) adapter is required to connect the TR60 controller to the HA6001 module.
 - i. A single Cat5 cable is connected from Serial 2 port on the HA6001 module, to the RJ45 input of the RS232-485 adapter.
 - ii. (3) 22AWG wires (up to 16AWG allowed) are connected from the screw terminals on the RS232-485 output, to the TR60 controllers RS485 input screw terminals. These connections are labeled D-/B, D+/A, and GND.

- b. An Authorization Code is required before the Thermostat option is visible on the Unity G.U.I. (LCD Consoles and TVDI). This Authorization Code is available by contacting Technical Support via email.

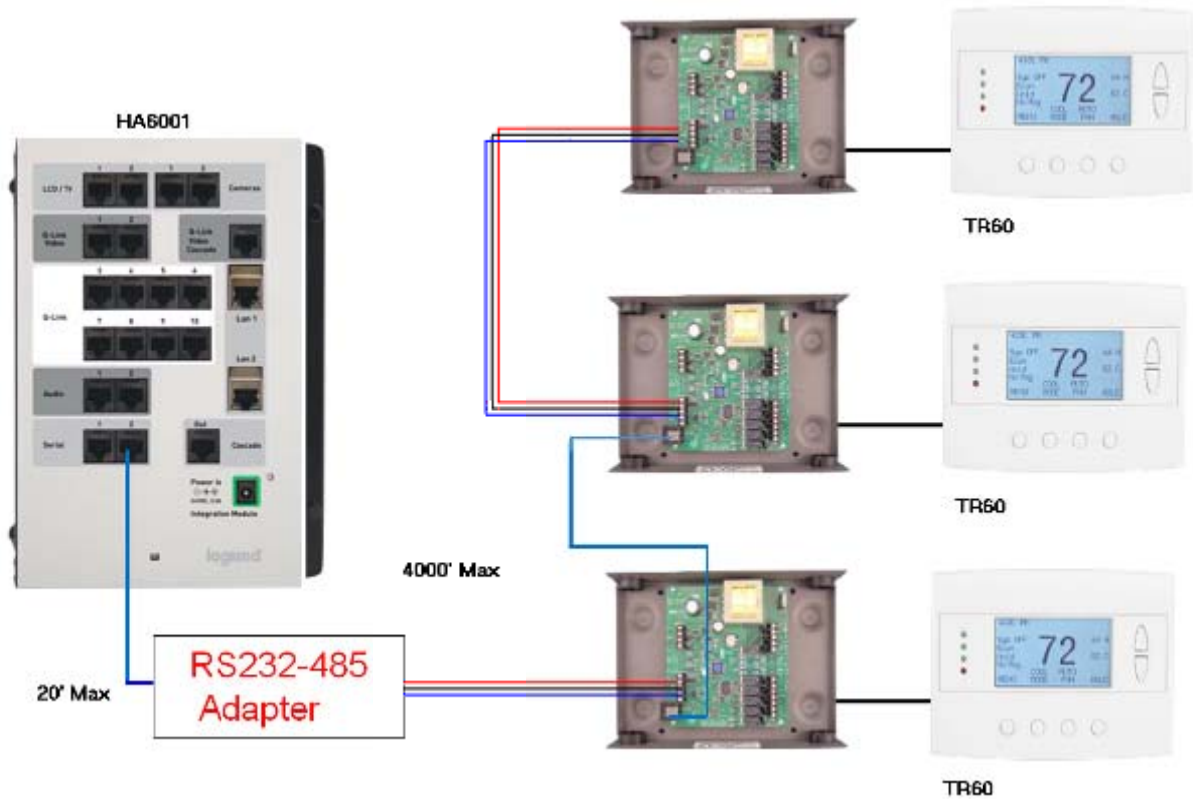

HVAC Unity Wiring

M. Connecting for LCD Expansion

1. **HA6101 Integration Expansion Module** – Each HA6101 module will allow for (2) additional LCD Consoles (HA5000/HA5009/HA5010) to be added to a Unity system.
 - a. The HA6101 will provide each LCD Console with its own unique Graphical User Interface (G.U.I.).
 - b. Each additional LCD Console will act as an Intercom device on the Unity system.
 - c. A maximum of (3) HA6101 module's can be connected to the HA6001 module, for a total of (8) LCD Consoles possible on a Unity system.
 - i. **NOTE:** The HA5201 Television Display Interface (TVDI) and HA5202 TVDI Expander module may also be used with the HA6101 module.
 - d. The G.U.I. from the HA6101 module has the same features and function as the G.U.I. from the HA6001 module.
 - i. **NOTE:** Display devices (LCD Consoles and TVDI) are connected to the HA6101 module in the same manner as they are on the HA6001 module. Refer to Installation Section of the HA6001 for required wiring for each display device.
2. **Intercom/Video Door Cascade Connections**
 - a. Cascade - A single Cat 5 cable must be connected between the Cascade IN on the HA6101 module to the Cascade OUT on the previous module. This

connection is used to carry Voice and Data between the modules. This cable is shown in blue in the following diagram

- i. **IMPORTANT:** The HA5001 Selective Call Intercom module may be used with the HA6101 module to allow additional Intercom devices (Room/Door/Patio Units) to be connected to the system.
 - 1) A maximum of (3) module's (HA6101 or HA5001) can be cascaded from the HA6001 Integration Module per Unity system.
 - 2) A maximum of 32 Intercom devices (LCD Consoles, Room/Door/Video Door/Patio Units) can be connected to the Unity system.
 - 3) HA5003 Video Door Units should not be connected to the HA5001 SCI module when in a Unity system. The Video from the Camera will not be displayed on the Unity system. Video Door Units are only to be connected to Q-Link Video ports 1 and 2 on the HA6001 module.
- b. **QLINK Video Cascade** – A special Cat 5 Y cable is supplied with each HA6101 module. This cable is required to allow Video Door Images to be displayed on all G.U.I. devices. The Y end of this cable will connect to QLINK Video 1 and 2 on the HA6101 module. The single end of this cable will connect to the QLINK Video Cascade port on the previous module. This cable is Yellow in color, and is shown in Yellow in the following diagram.
 - i. **NOTE:** The Y end of the cable has numbers 1 and 2 on the ends to indicate which QLINK Video port each end must connect too.
 - ii. **IMPORTANT:** A maximum of (2) HA5003 Video Doors can be connected to a Unity system when using the HA6101 Expansion Module. The HA6101 module does not increase the number of Cameras, or Video Doors, allowed on a Unity system.

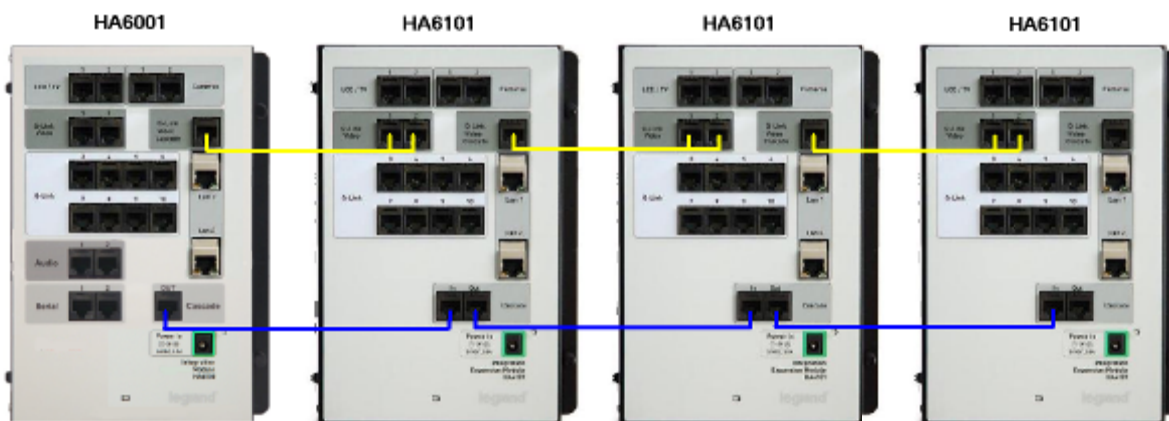

HA6101 Module Intercom/Video Door Cascade Wiring

3. **Extra LANS** – Each HA6101 module will require (2) Local Area Network (LAN) connections to a Route. This is in addition to the (2) LAN connections required for

the HA6001 module. Refer to the following diagrams below for recommended LAN wiring.

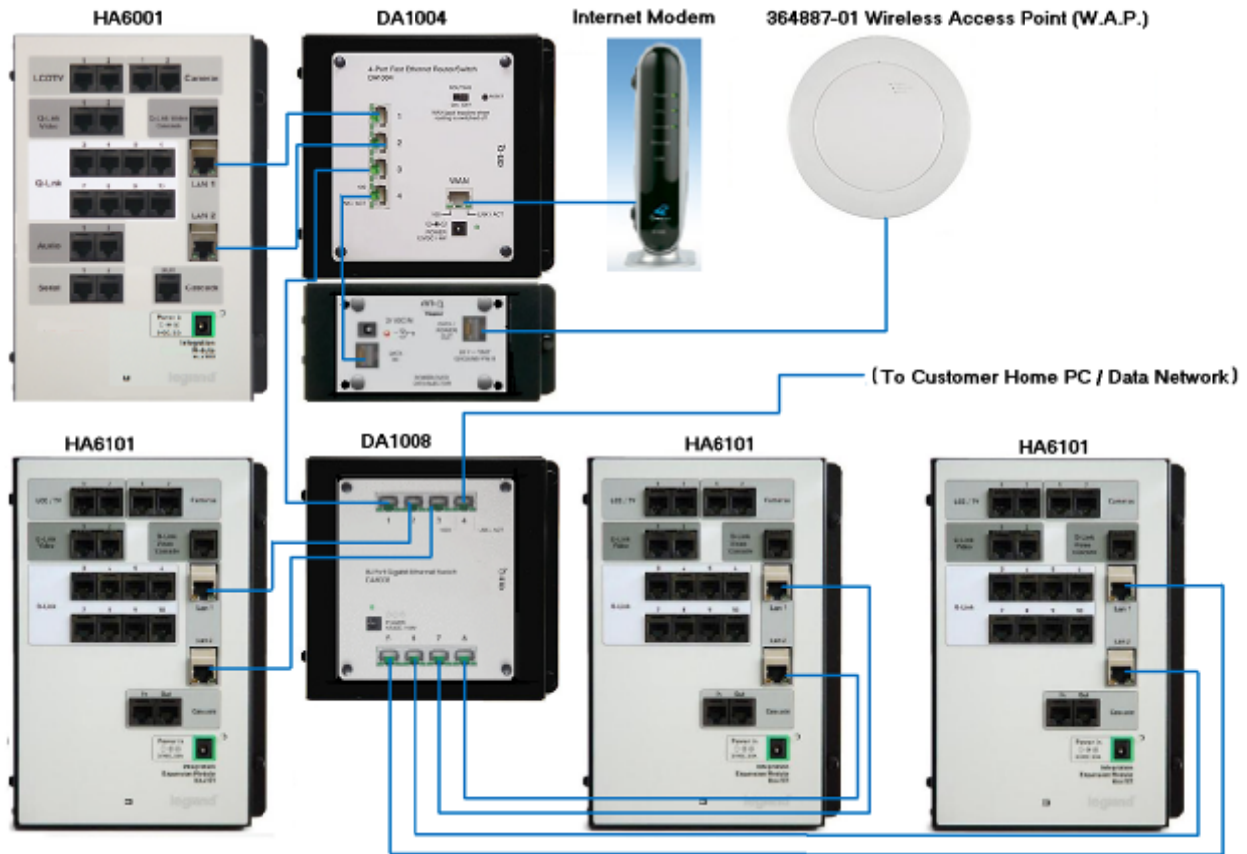

HA6101 Expansion Module Local Area Network Wiring

4. Extra Power

a. The CM1048, CM1010, CM1011, DA1004, DA1008, and Wireless Access Point Power Injector Module, can all be powered from the PW1010 Universal Power Distribution Module, when these devices are connected to a Unity system.

i. **IMPORTANT: All devices in the Unity system should be connected in such a way to allow the entire system to be powered ON and OFF simultaneously. This is required to ensure proper system discovery.**

ii. **NOTE:** It may be desirable to power the entire Unity system and data network from a U.P.S. device.

1) This will allow for operation of the Intercom in the event of a power outage.

2) This will allow users to continue to access the Internet in the event of a power outage (providing the WAN is still available).

3) This will prevent the Unity systems IP address from changing, preventing the user from having to store a new IP address in their laptop or mobile devices web browser. (Unity IP address is used to access control of the Lighting, Music, and Player functions, from these

devices). This would be very valuable in areas of the country where frequent power outages occur.

- b. Each HA6101 module requires its own PW1060 24V 2.5A power supply to run the module.
 - i. **NOTE:** Power Supplies running the HA6001 and HA6101 modules should not be shared with any other device in the system.
 - ii. **NOTE:** The PW1010 Universal Power Distribution Module should NOT be used to power HA6001 or HA6101 module(s).

5. CM1048 Camera/LCD Combo Module – The CM1048 module is designed to allow four cameras to be connected to the HA6001 and HA6101 modules. The CM1048 is required for LCD Expansion of the Unity system.

- a. HA6001 Wiring - (2) Cat 5 cables are connected from the HA6001 Camera 1 and 2 ports, to the “Display/IM” ports 1 and 2, of the CM1048. These cables will provide the HA6001 module with the video/audio of the four cameras connected to the CM1048 module. Refer to the diagrams in the HA6101 wiring section below.
 - i. The CM1048 sources will appear in the Unity G.U.I. (via the LCD Console or TVDI) as Cameras 1 through 4 (under Cameras). These correspond to Inputs 1 through 4 on the CM1048.
 - ii. **NOTE:** CM5003 Video Door Units cannot be connected to the CM1048. They may only be connected to the Q-Link Video 1 and 2 ports on the HA6001 module, and will appear as Camera 5 and 6 respectively (under Cameras) from the Unity G.U.I., when the CM1048 is used.
 - iii. **IMPORTANT:** Only CM5002 Ball Cameras can be connected to the RJ45 Input ports of the CM1048. Damage may occur if other cameras are connected to directly to the RJ45 ports.
 - 1) **NOTE:** Other Legrand brand Cat 5 Cameras may be used with the CM1048 module. This requires a CM1011 Camera module. Refer to “CM1048 Camera Options” section below.
 - 2) 3rd party Cameras may be connected via the RCA type Video/Audio inputs on the CM1048 module.
 - a) Video input must be standard NTSC composite video (un-modulated)
 - b) Only one device is allowed, per input, on the CM1048 module (Limit of (4) cameras maximum)
- b. HA6101 Wiring - The following diagrams show how to connect the wiring from the CM1048, to the HA6001 and HA6101 module(s), for 4, 6, and 8 LCD systems.
 - i. 4 LCD System Wiring – (2) additional Cat 5 cables are required to be connected from CM1048 module’s “Display/IM” ports 3 and 4, to Camera ports 1 and 2, on the HA6101 expansion module.

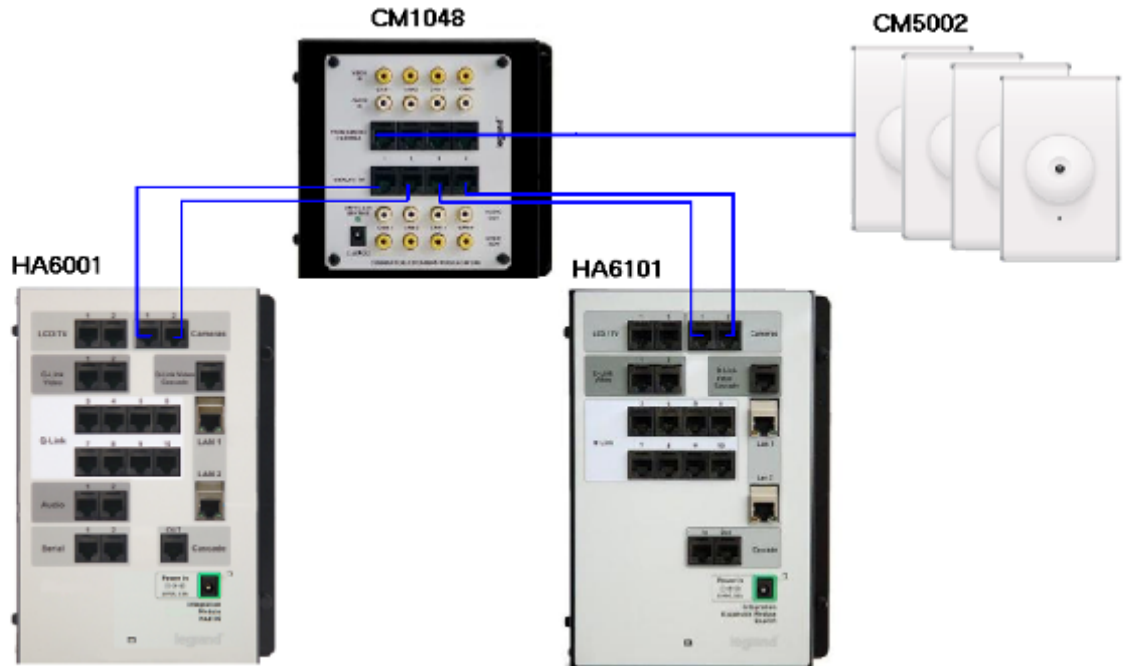

HA6101 (4) LCD expansion CM1048 wiring

- ii. 6 LCD System Wiring – Wiring for a 6 LCD system requires a 2nd HA6101 module, as well as a CM1010 LCD module.
 - 1) (2) Cat 5 cables are connected from the CM1010 ports labeled “OUT TO LCD” 1 and 2, to Camera ports 1 and 2 on the 2nd HA6101 module. These cables provide the 2nd HA6101 module with the 4 audio/video sources from the CM1048 module.
 - 2) Audio/Video RCA cables must be connected between the CM1048 module’s outputs, and the CM1010 module’s inputs.

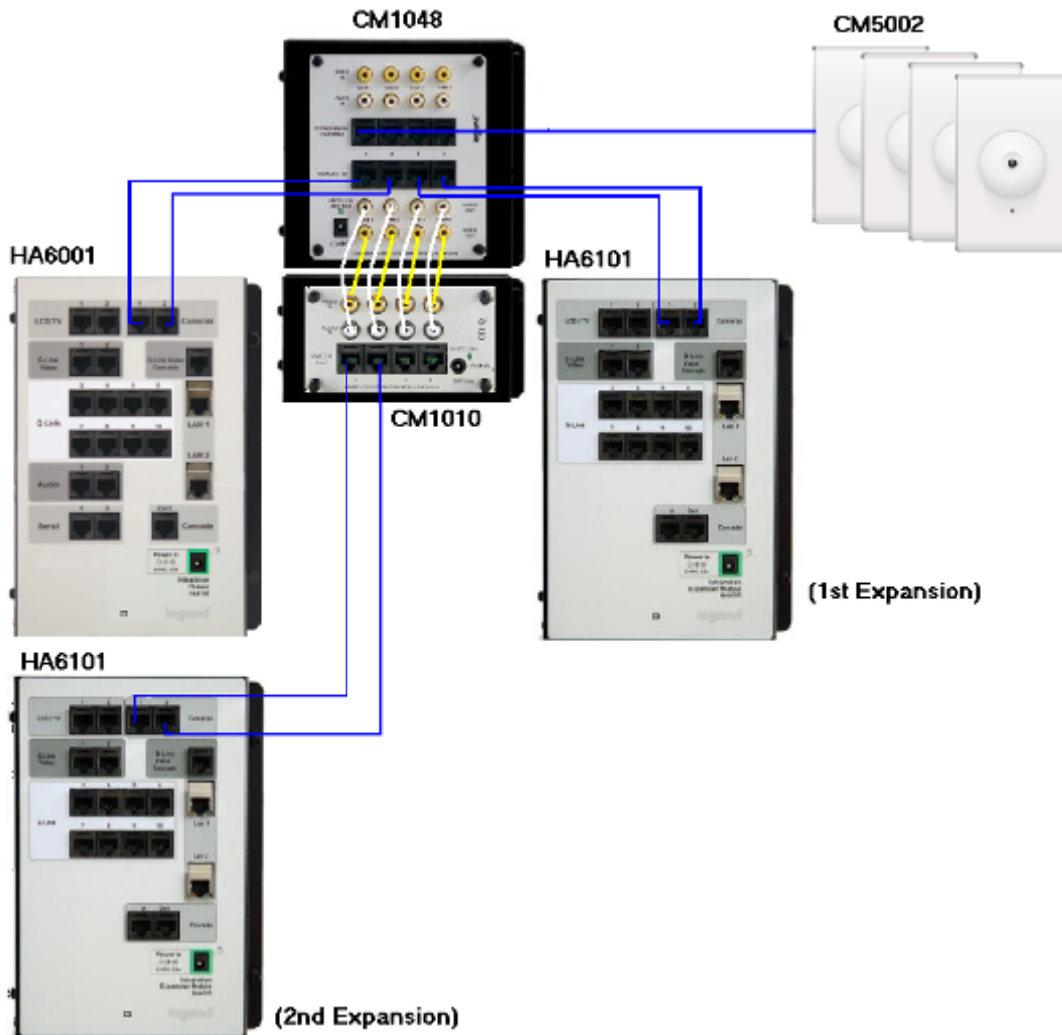

HA6101 (6) LCD expansion CM1048 wiring

- iii. 8 LCD System Wiring – Wiring for an 8 LCD system requires a 3rd HA6101 module, along with the CM1010 LCD module.
 - 1) (2) Additional Cat 5 cables are connected from the CM1010 ports labeled “OUT TO LCD” 3 and 4, to Camera ports 1 and 2 on the 3rd HA6101 module. These cables provide the 3rd HA6101 module with the 4 audio/video sources from the CM1048 module.
 - 2) Audio/Video RCA cables must be connected between the CM1048 module’s outputs, and the CM1010 module’s inputs.

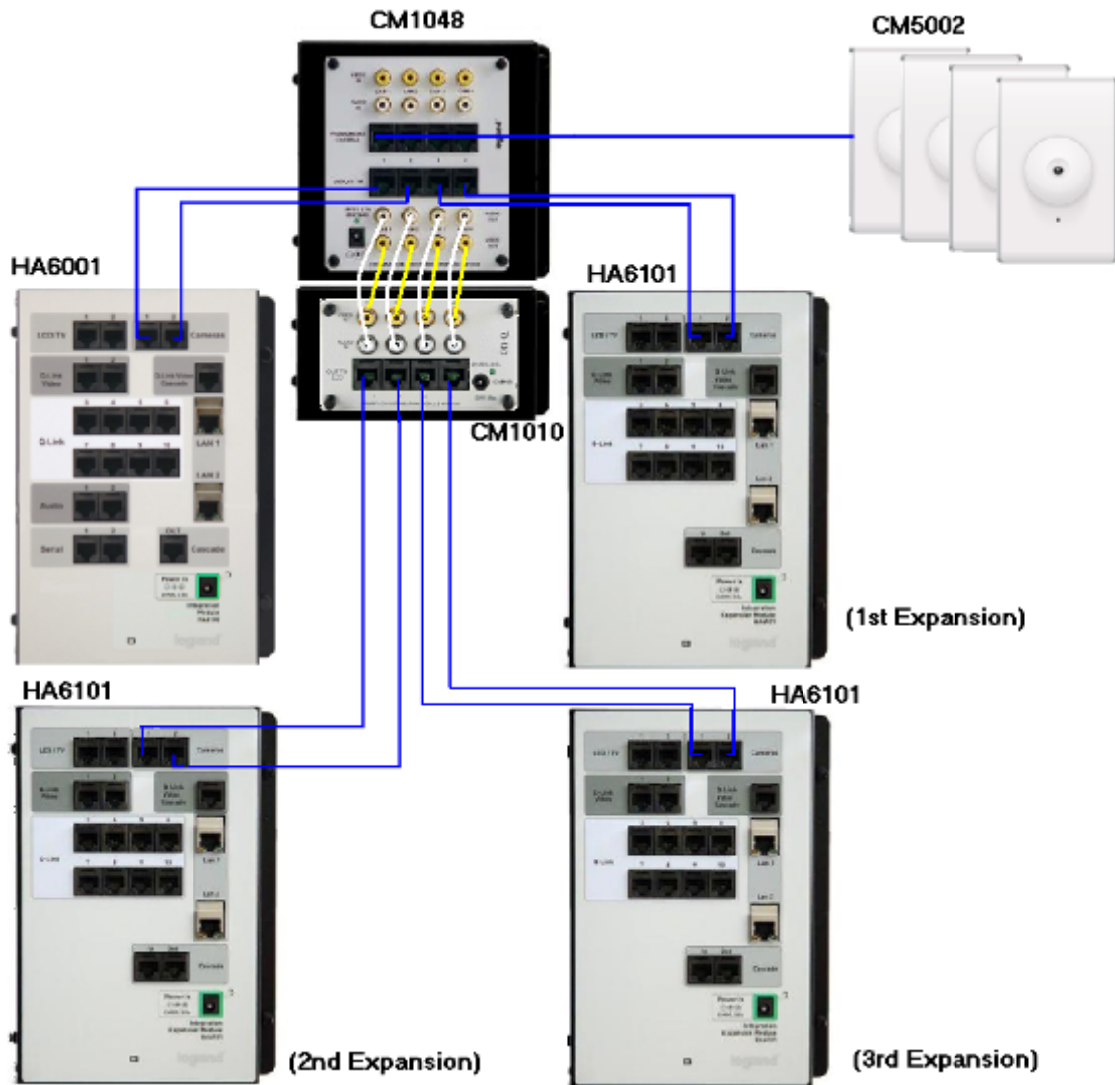

HA6101 (8) LCD expansion CM1048 wiring

- c. CM1048 Camera Options – If cameras other than the CM5002 are desired, the CM1011 Camera Module can be connected to the CM1048 module.
- 1) A single Cat 5 cable must be ran from each Camera location to the CM1011 Camera module.
 - 2) Audio/Video RCA cables must be connected between the CM1011 module's outputs, and the CM1048 module's RCA inputs.

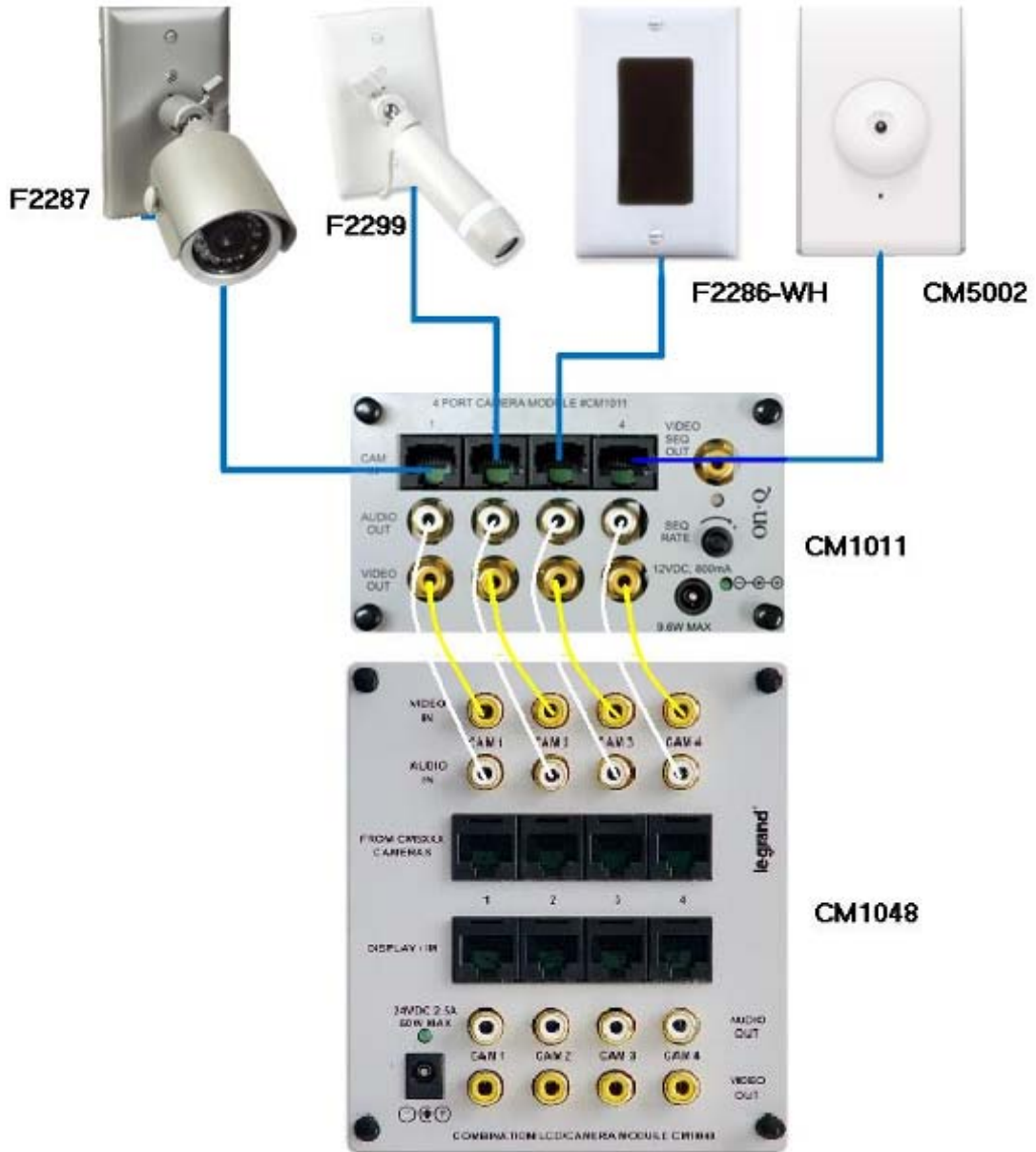

CM1048 Legrand Camera Options

N. Boot Sequences

1. Boot-Up Sequence

When the Unity system is installed and powered up, it performs a Boot-Up sequence (also called System Initialization process) as described below. If it is power cycled at a later date, it performs the same process. The times and indications given below are presented to help you understand what is taking place during this Boot-Up process. **The total time will change depending on the size of the system.**

0:00

- LCD/TVDI GUI's Dark
- LCD Buttons Flash
- Green LED on TVDI will blink
- Room Units display "Discovering"

0:35

- TVDI Shows Legrand Logo with Progress Bar Filling
- LCD Buttons continue Flashing

0:50

- TVDI Turns Off (Display Blank)
- LCD Turns Off (if connected to DSP 1)
- LCD Displays Legrand Logo with Progress Bar (if manually turned on)
- Room Units display "Unit Not Discovered" if no IC5001 cascaded
- Room Units display "Address Jumpers Incorrect" if IC5001 cascaded

1:06

- LCD Turns Off (if connected to DSP 2)
- LCD Displays Legrand Logo with Progress Bar (if manually turned on)

1:10

- LCD Display Blank (if connected to DSP 1)

1:30

- LCD Display Blank (if connected to DSP 2)

1:50

- LCD/TVDI display "System Initializing Please Wait"

2:00

- LCD Display Blank
- LCD Buttons Flash
- Green LED on TVDI will blink
- TVDI displays "System Initializing Please Wait"
- Room Units display "Discovering"

2:30

- LCD Turns Off
- LCD displays System Initializing Please Wait (if turned on)

3:00

- Bubbles Appear to move behind "System Initializing Please Wait" Message on LCD/TVDI GUI

3:25

- Homescreen Appears on LCD/TVDI
- Room Units display Names of all other SCI Units

**Up to an additional 1:30 seconds can be added to the time after 2:30 for larger scale systems
Total discovery time is approximately 3:30 to 4:30 depending upon system size**

2. Software Update Process

Once a Unity system is operational, it retains the software revision that it was initially Booted-Up on and will continue to reload that revision if power is cycled, etc. But, there may come a time when the customer needs to update his software to a newer revision level to take advantage of features that exist in the latest release. To perform an UPDATE, simply go to Setup and System on the LCD Console and press the soft key under the word "Update" on the LCD screen and follow the prompts through the process. While the update is taking place, the following screens will appear on the LCD Console.



Once the software has been updated, the Unity system will perform a Boot-Up or System Initialization process similar to the one described in the previous sub-section. It then retains that new software revision it was updated to and will continue to reload that revision if power is cycled, etc.

3. Software Reset Process

If you ever need to restore the system to factory defaults, go to Setup -> System and press the soft key under the word "Reset" on the LCD screen and follow the prompts.

WARNING: The Reset process takes the Unity system back to factory defaults conditions, completely eliminating any personalization that was done to the system.

IV. Setup Guide for Web and LCD Console

A. Setup the Network

On the Unity system, under “Setup: Network info”, we list a web address to use for accessing web setup:



Using any PC on the network, this address may be used to access the Web Setup feature:

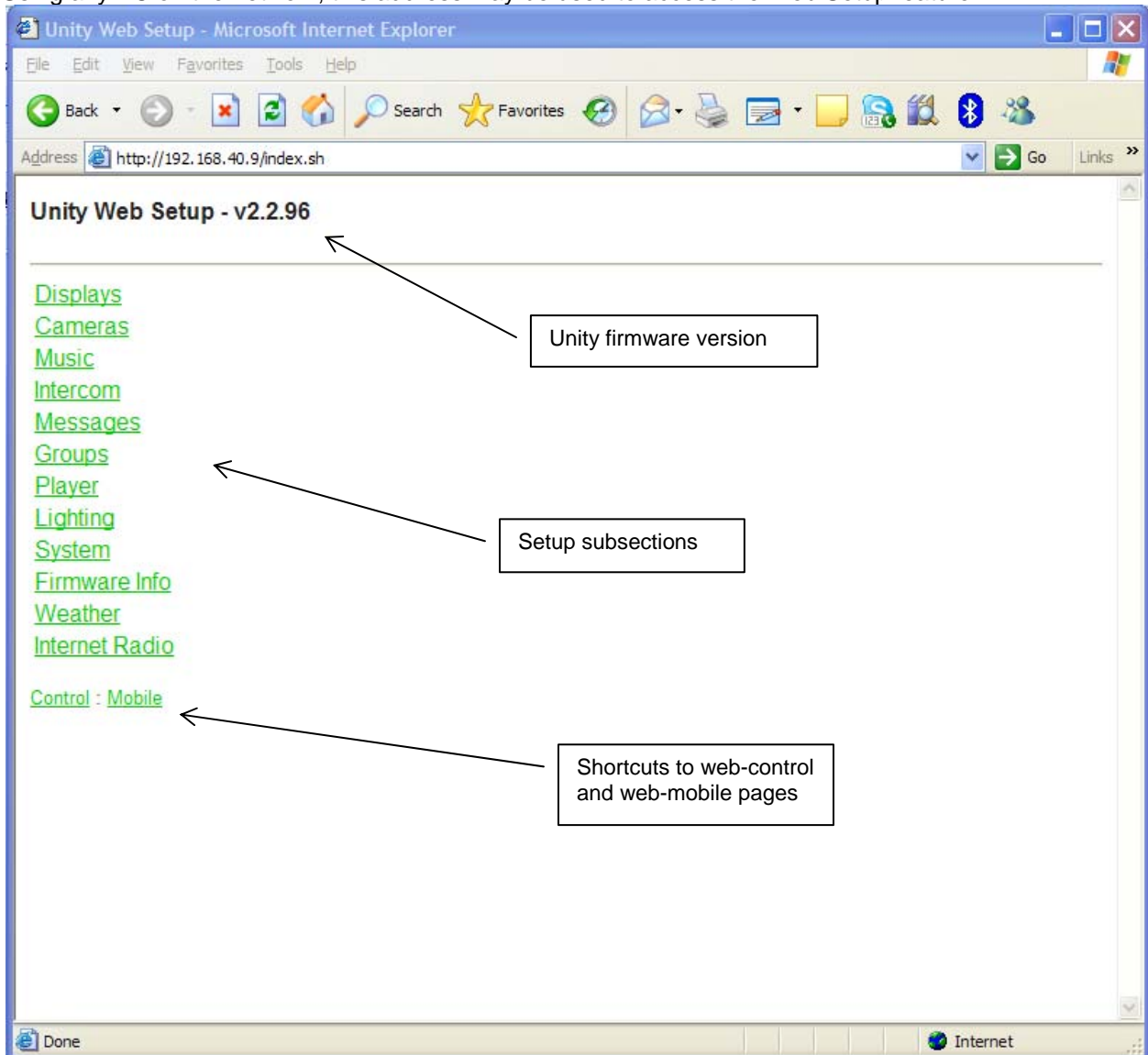

From here, we can pick a specific subsection to setup:

Displays: settings for the LCD Consoles and TVDI's in the system. Includes lyriQ audio settings for any LCD Consoles with lyriQ add-on boards.

Cameras: settings for and cameras connected to the system.

Music: settings for any lyriQ components connected to the system.

Intercom: settings for any intercom-related devices.

Messages: settings related to the messaging feature.

Groups: allows intercom units to be grouped together.

Player: settings for the Digital Music Manager.

Lighting: settings for and RF lighting connected to the system.

System: allows for system-level settings (time, date, etc).

Firmware Info: displays the firmware revisions for all devices connected to the system.

Weather: allows for setting the location for the weather feature.

Internet Radio: allows for Username and Logon to be entered for RadioTime access.

B. Setup the Displays:

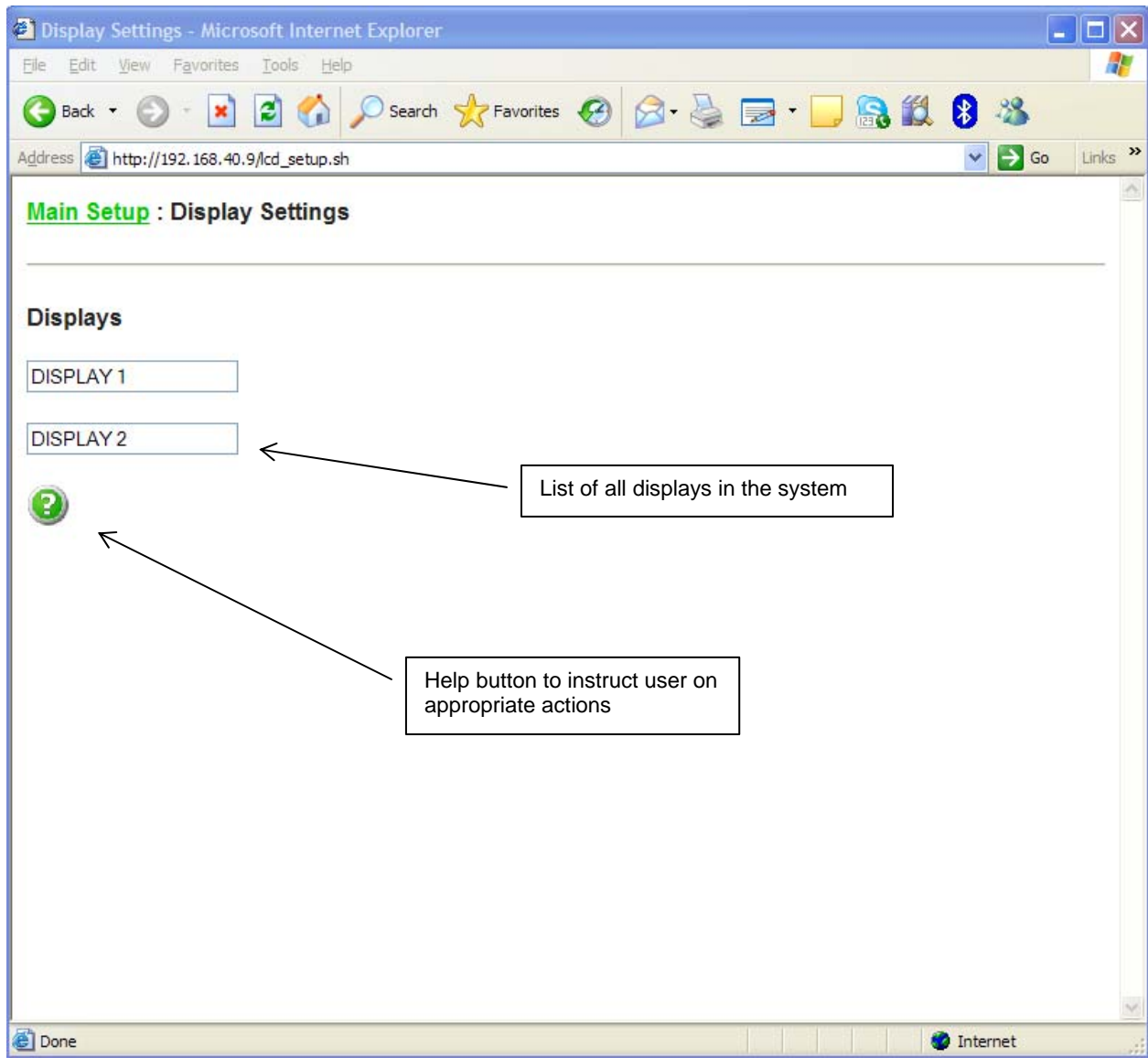

Choosing a Display allows the user to edit the settings for the display:

DISPLAY SETTINGS:

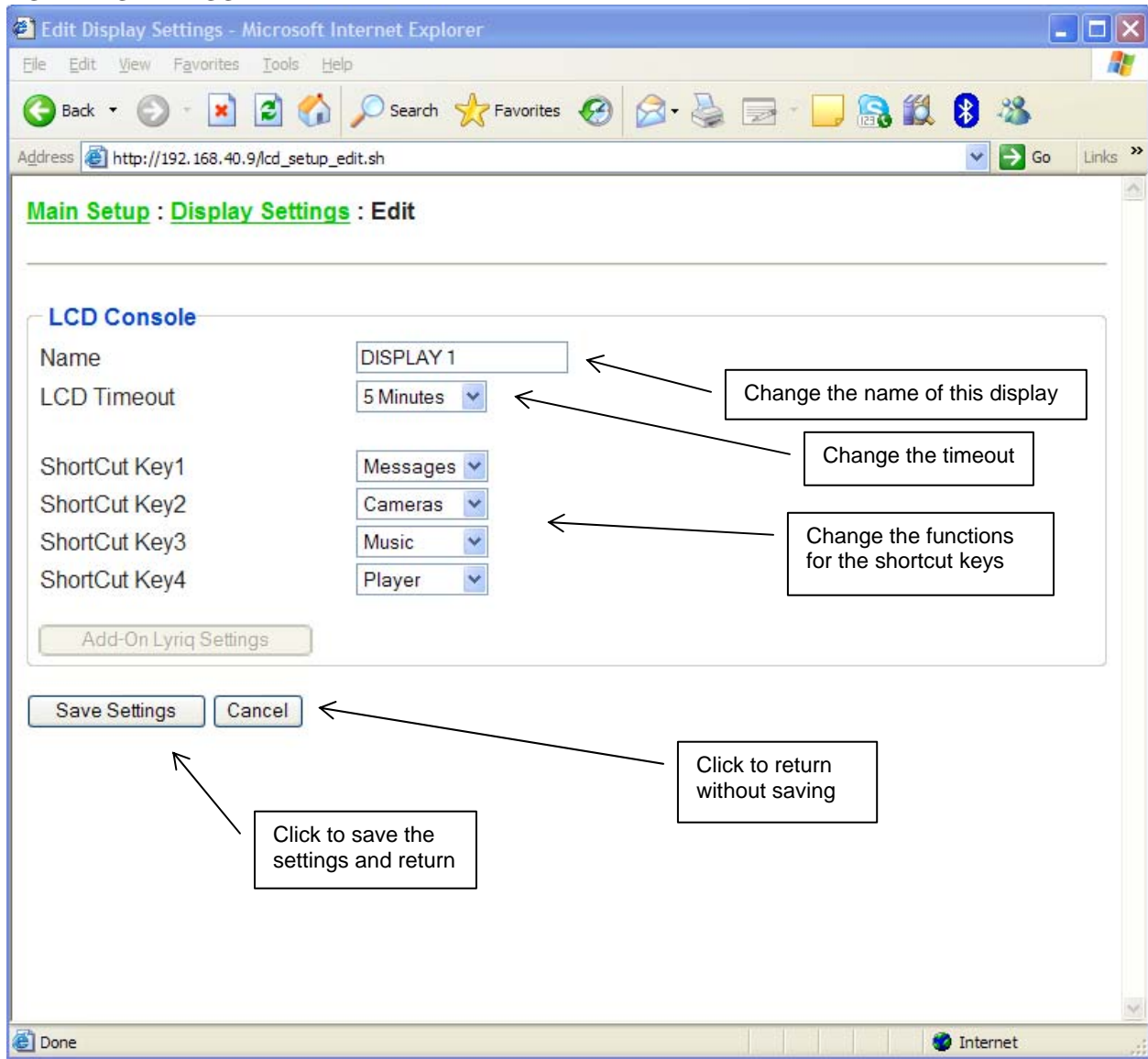

If the display has a lyriQ add-on board installed, the Add-On lyriQ Settings box will be active. Selecting this brings up the settings for the lyriQ add-on board:

DISPLAY SETTINGS:

Main Setup : Display Settings : Add-On Lyriq Settings - DISPLAY 2

Whole House Exposed	<input checked="" type="radio"/> Exposed <input type="radio"/> Hidden	Select if this zone will accept whole-house control
Turn On Volume	<input checked="" type="radio"/> Specified Volume: <input type="text" value="15"/> <input type="radio"/> Last Volume	Select the volume that this zone will turn on to
Max Volume	<input type="text" value="100"/>	Maximum volume allowed for this zone
IR Target/IR Repeat	<input checked="" type="radio"/> IR Target Enabled/IR Repeat Enabled <input type="radio"/> IR Target Enabled/IR Repeat Disabled <input type="radio"/> IR Target Disabled/IR Repeat Disabled	IR settings (see notes below)
Balance (%)	<input type="text" value="50"/> <L Center R> <input type="text" value="50"/>	Left/Right balance
IR Repeater Pattern	Source 1 <input type="radio"/> 40 kHz <input checked="" type="radio"/> Mixed 40 kHz/56 kHz <input type="radio"/> 56 kHz	IR Repeat patter (by source) (see notes below)
	Source 2 <input type="radio"/> 40 kHz <input checked="" type="radio"/> Mixed 40 kHz/56 kHz <input type="radio"/> 56 kHz	
	Source 3 <input type="radio"/> 40 kHz <input checked="" type="radio"/> Mixed 40 kHz/56 kHz <input type="radio"/> 56 kHz	
	Source 4 <input type="radio"/> 40 kHz <input checked="" type="radio"/> Mixed 40 kHz/56 kHz <input type="radio"/> 56 kHz	

Save Settings Cancel

NOTES:

- **IR Target/IR Repeat:** This allows the user to choose the functionality of the IR target.
 - **IR Target Enable/IR Repeat Enabled:** DEFAULT. The device accepts local IR signals, and relays them to the rest of the lyriQ system.
 - **IR Target Enable/IR Repeat Disabled:** The device accepts local IR signals, but will NOT relay them the rest of the lyriQ system. This could be used if an

exceptional amount of IR noise is being seen at this location and we want to limit the exposure to the rest of the system.

- **IR Target Disable/IR Repeat Disabled:** The device accepts local IR signals, but will NOT relay them the rest of the lyriQ system. This could be used if the device is seeing IR commands that are not intended for it (a nearby device, for example).
- **IR Repeater Pattern:** This allows the user to choose the frequency of the IR repeater functionality.
 - **40KHz: Commands are repeated at a frequency of 40 kHz.**
 - **Mixed 40KHz/56kHz: DEFAULT. Commands are repeated at a mixed frequency. This should be sufficient for most devices.**
 - **56KHz: Commands are repeated at a frequency of 56 kHz.**

C. Setup the Cameras

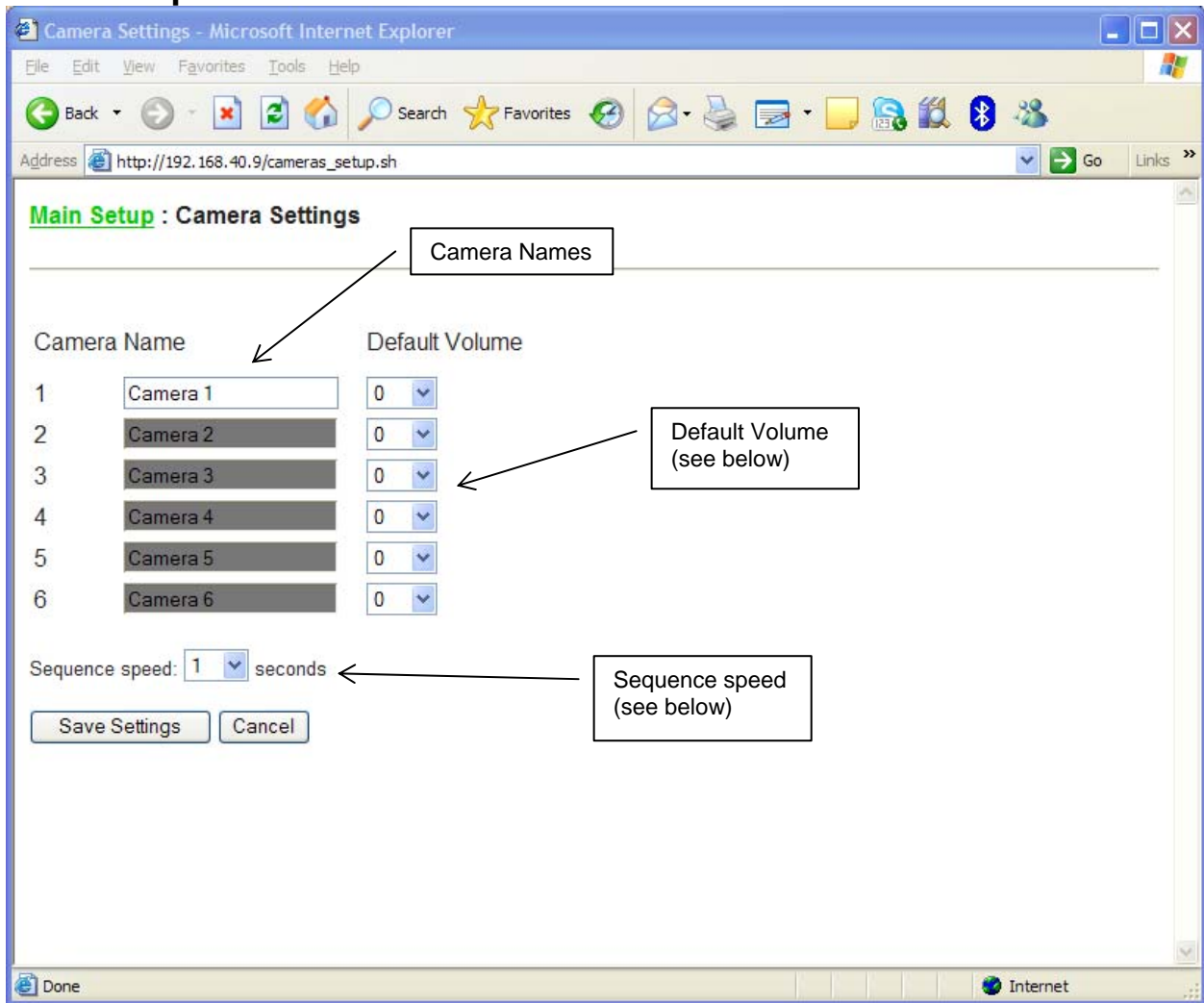

NOTES:

- **Default Volume:** If the camera has a microphone, this is the volume that will be automatically set for the LCD Console when this camera is chosen in the Cameras screen. When the user leaves the Cameras screen, the volume will be restored to its original level.
- **Sequence speed:** This is the amount of time that the system will spend on each camera during the sequencing operation. Values can be set from 1 second to 30 seconds.

D. Setup Music

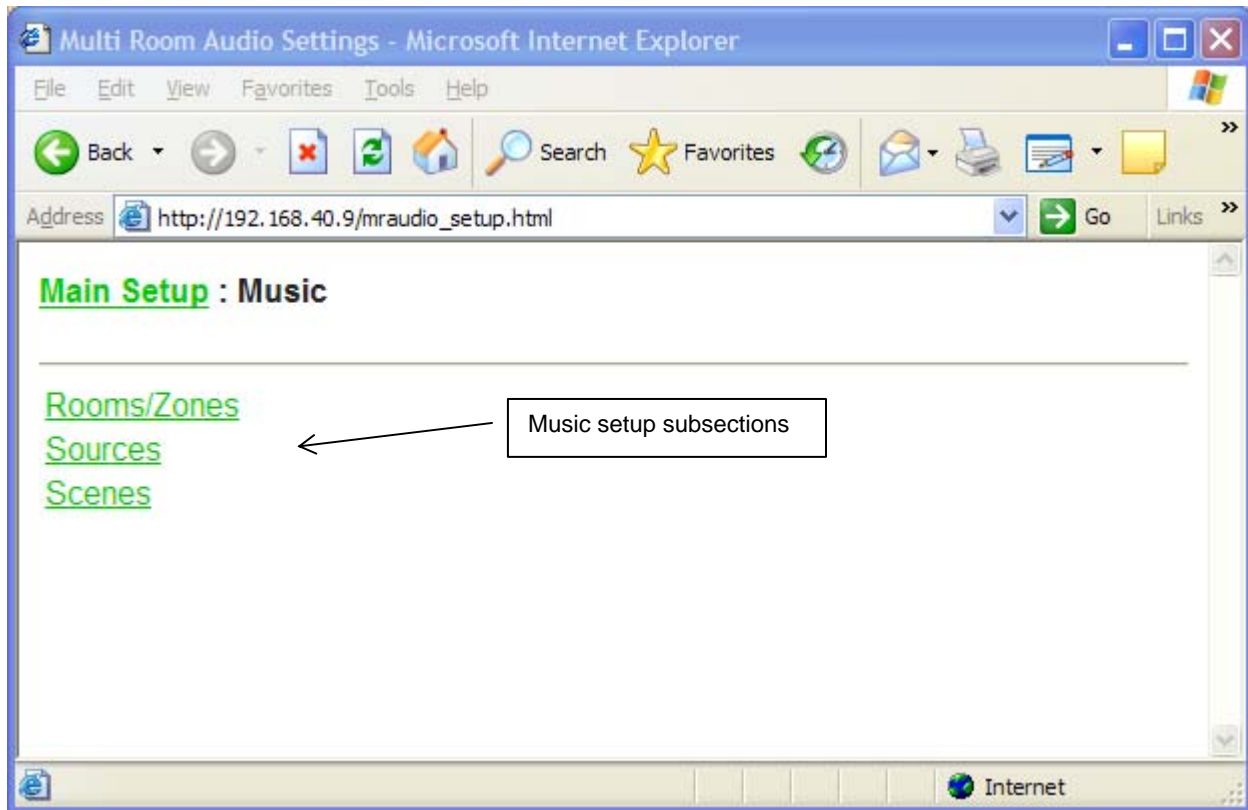

From here, we can pick a specific Music subsection to setup:

Rooms/Zones: settings for the lyriQ Zones.

Sources: settings for the lyriQ Sources.

Scenes: settings for lyriQ Scenes. This allows the user to set up specific audio scenes, such as "party" or "whole house 50%".

MUSIC: Rooms/Zones:

Music - Zone Settings - Microsoft Internet Explorer

Address: http://192.168.40.9/mraudio_zones_setup.sh

Main Setup : Music : Rooms/Zones

Room/Zone	Name	Keypad Type	Locals
1	Zone 1	Studio STD.	1
2	Zone 2	Not Connected	0
3	Zone 3	Not Connected	0
4	Zone 4	Not Connected	0
5	Zone 5	Not Connected	0
6	Zone 6	Not Connected	0
7	Zone 7	Not Connected	0
8	Zone 8	Not Connected	0
9	Zone 9	Not Connected	0
10	Zone 10	Not Connected	0
11	Zone 11	Not Connected	0
12	Zone 12	Not Connected	0
13	Zone 13	Studio H.P.	0
14	Zone 14	Not Connected	0
15	Zone 15	Not Connected	0
16	Zone 16	Studio STD.	0

Annotations:

- Room/Zone Names (points to Name column)
- Keypad Types (for information only – not editable) (points to Keypad Type column)
- Number of local source (for information only – not editable) (points to Locals column)

Note that the ports on the 4x8 Module (AU1002) correspond directly to these Room/Zones. Ports 9-16 require a 4x8 Zone Expander (AU1023) and a second 4x8 Module (AU1002).

Buttons: Save Settings, Cancel

MUSIC: Sources:

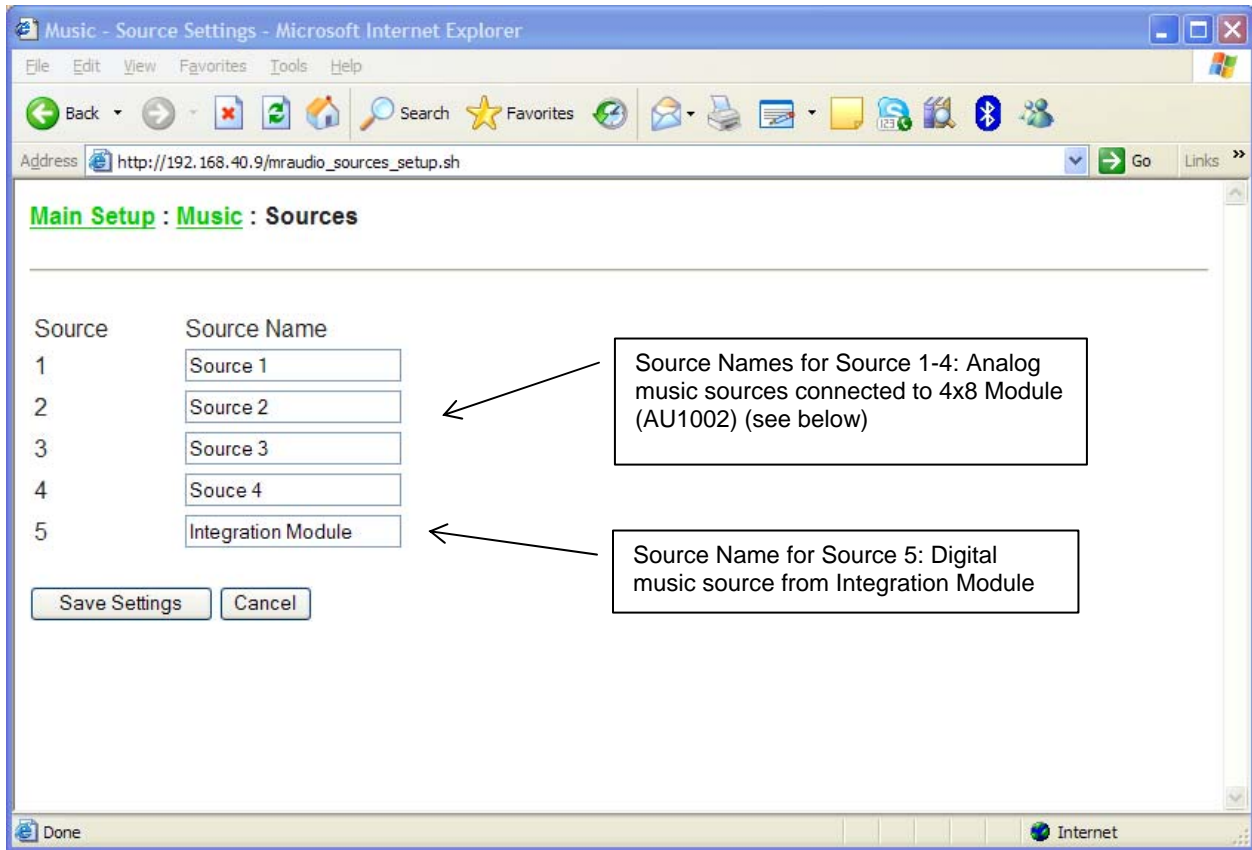

NOTES:

Source Names: If an AU1014 lyriQ 1x4 Module is used in place of an AU1002 lyriQ 4x8 Module, only Source 1 and Source 5 will be available.

MUSIC: Scenes:

Scene Name

1	<input type="text" value="Party"/>
2	<input type="text" value="empty slot"/>
3	<input type="text" value="empty slot"/>
4	<input type="text" value="empty slot"/>
5	<input type="text" value="empty slot"/>
6	<input type="text" value="empty slot"/>
7	<input type="text" value="empty slot"/>
8	<input type="text" value="empty slot"/>

Scene names. Click on the box to edit or create a scene.

Delete scene. Click on the 'x' to delete the scene.

MUSIC: Scenes: Party:

Music - Scene Settings - Microsoft Internet Explorer

Address: http://192.168.40.9/mraudio_scenes_setup_edit.sh

Main Setup : Music : Scenes : Edit

Scene Settings : Edit Scene

Scene Name: Party

Zone names and types. For information only – not editable.

Source to set for each zone (if it is included in the scene).

	Zone Name	Keypad Type	Source	Volume	Status	Include
	ALL		Source 1	00	Off	<input type="checkbox"/>
1	Kitchen	Studio STD.	Integration Module	75	On	<input checked="" type="checkbox"/>
2	Zone 2	N/A	Source 1	0	Off	<input type="checkbox"/>
3	Zone 3	N/A	Source 1	0	Off	<input type="checkbox"/>
4	Zone 4	N/A	Source 1	0	Off	<input type="checkbox"/>
5	Zone 5	N/A	Source 1	0	Off	<input type="checkbox"/>
6	Zone 6	N/A	Source 1	0	Off	<input type="checkbox"/>
7	Zone 7	N/A	Source 1	0	Off	<input type="checkbox"/>
8	Zone 8	N/A	Source 1	0	Off	<input type="checkbox"/>
9	Zone 9	N/A	Source 1	0	Off	<input type="checkbox"/>
10	Zone 10	N/A	Source 1	0	Off	<input type="checkbox"/>
11	Zone 11	N/A	Source 1	0	Off	<input type="checkbox"/>
12	Zone 12	N/A	Source 1	0	Off	<input type="checkbox"/>
13	Living Room	Studio H.P.	Integration Module	50	On	<input checked="" type="checkbox"/>
14	Zone 14	N/A	Source 1	0	Off	<input type="checkbox"/>
15	Zone 15	N/A	Source 1	0	Off	<input type="checkbox"/>
16	Basement	Studio STD.	Integration Module	50	On	<input checked="" type="checkbox"/>

Volume to set for each zone (if it is included in the scene).

Status to set for each zone (if it is included in the scene). Status selections are Off, On and Mute.

Checkboxes to indicate if the zone is to be included in the scene.

Save Scene Cancel

E. Setup the Intercom Units

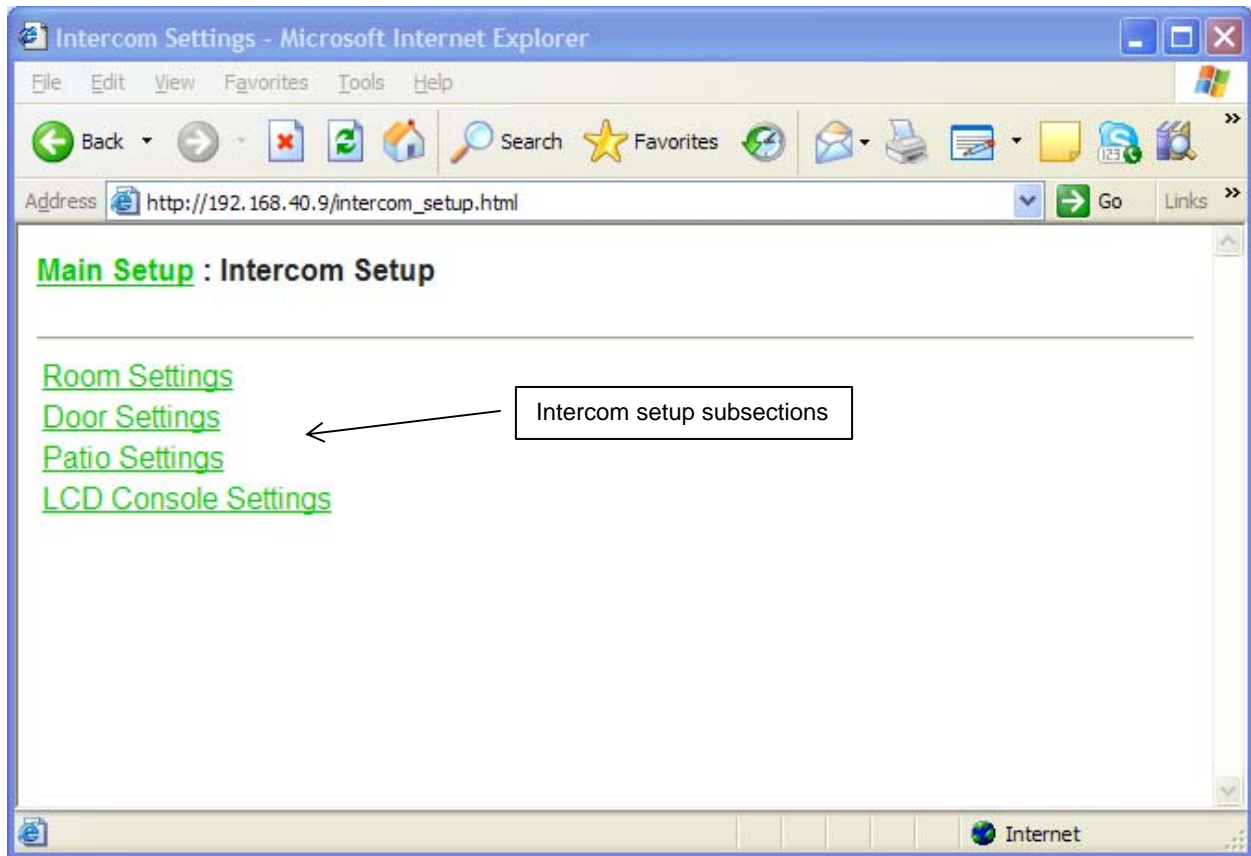

From here, we can pick a specific Intercom subsection to setup:

Room Settings: Intercom settings specific to SCI Room Units.

Door Settings: Intercom settings specific to SCI Door Units.

Patio Settings: Intercom settings specific to SCI Patio Units.

LCD Console Settings: Intercom settings specific to the LCD Consoles.

INTERCOM: SELECTION SCREEN:

Intercom Room Settings - Microsoft Internet Explorer

File Edit View Favorites Tools Help

Back Forward Stop Home Search Favorites Refresh Print Mail News RSS Feeds

Address http://192.168.40.9/intercom_room_setup.sh Go Links

Main Setup : Intercom Setup : Rooms

Room Settings









Room names. Click on the box to access the settings for that unit. There will be similar lists for Doors, Patios and LCD Consoles.

Click the target to start the "locating" feature. The selected intercom unit will start beeping to assist in locating and naming. The unit will beep 5 times.

Done Internet

INTERCOM: ROOM SETTINGS:

Room Settings

Name: ROOM 1

Camera Index: None

Select Music Rooms/Zones to mute when this intercom is in use.

Room/Zone A: None

Room/Zone B: None

Room/Zone C: None

Room/Zone D: None

Dynamic Sorting: Enabled

Mute Allowed: Yes

Monitor Allowed: Yes

Chime Volume: 75

Screen Timeout: 1 Minute

Buttons: Save Settings, Cancel

Callouts: Unit Name, Associated Camera (see below), Associated Audio Zone(s) (see below), Intercom settings (see below)

NOTES:

Camera Index: This allows a camera to be associated with this intercom unit. If a camera is chosen, it will be displayed in an insert window on the Intercom screen when this unit is highlighted.

Room/Zone A,B,C,D: This allows lyriQ Audio Zone(s) to be associated with this intercom unit. If an audio zone is chosen, it will be automatically muted during an intercom call involving this intercom unit.

Dynamic Sorting: This determines if the unit list for this intercom unit will be displayed alphabetically, or adjusted dynamically based on which units are called most frequently.

Mute Allowed: If set to No, this intercom unit may not be muted.

Monitor Allowed: If set to No, this intercom unit may not be monitored.

Chime Volume: This is the volume at which a door chime will play at this unit. This can be set to 0 for a location that does not wish to hear the door chime.

Screen Timeout: This determines how long the screen will remain active on this intercom unit following its last use.

INTERCOM: DOOR SETTINGS:

Intercom Door Settings - Microsoft Internet Explorer

Address: http://192.168.40.9/intercom_door_setup_edit.sh

Main Setup : Intercom Setup : Doors

Door Settings

Name: DOOR 1

Chime: Legrand Chime

Volume: 50

Chime Volume: 50

Release: Disable

Trigger: Disable

Camera Index: None

Select Music Rooms/Zones to mute when this intercom is in use.

Room/Zone A: None

Room/Zone B: None

Room/Zone C: None

Room/Zone D: None

Door Messaging: No

Door Sensor: No

Save Settings Cancel

Unit Name

Intercom settings (see below)

NOTES:

Chime: Selects which chime is played for this door unit. 20 Door chimes are pre-installed. Chimes 21-30 are reserved for user-defined custom door chimes.

Volume: Sets the volume for this door unit for any intercom calls.

Chime Volume: This is the volume at which a door chime will play at this door unit.

Release: Selects which output (if any) will be wired to this door release. If selected, a door release selection will be available under this door unit in the Intercom list.

Trigger: Selects which output (if any) will be wired to the trigger associated with this door unit. If selected, this output will be triggered when the doorbell button is pressed on this door unit.

Camera Index: This allows a camera to be associated with this door unit. The camera image will be displayed in an insert window on the Intercom screen when this unit is highlighted.

NOTE: this value is automatically filled for a Video Door Unit and cannot be changed.

Room/Zone A,B,C,D: This allows lyriQ Audio Zone(s) to be associated with this intercom unit. The audio zone/s will be automatically muted during an intercom call involving this intercom unit.

Door Messaging: This allows a visitor to leave messages at this door unit.

Door Sensor: This setting instructs the Integration Module that the door unit is wired to a sensor that allows us to interrupt the door messaging feature if the door is opened.

INTERCOM: PATIO SETTINGS:

Intercom Patio Settings - Microsoft Internet Explorer

Address: http://192.168.40.9/intercom_patio_setup_edit.sh

Main Setup : Intercom Setup : Patios

Patio Settings

Name	PATIO 1
Status	On
Volume	70
Chime Volume	75
All Call	No
Monitor	No
Timeout	1 Minute
Camera Index	None
<i>Select Music Rooms/Zones to mute when this intercom is in use.</i>	
Room/Zone A	None
Room/Zone B	None
Room/Zone C	None
Room/Zone D	None

Save Settings Cancel

Unit Name

Intercom settings (see below)

NOTES:

Name: Allows user to enter the desired name of the Patio.

Status: Allows the patio to be turned off to prevent calls into the house.

Volume: Sets the volume for this patio unit for any intercom calls.

Chime Volume: This is the volume at which a door chime will play at this patio unit.

All Call: Determines if this patio unit is included in any all-call intercom calls.

Monitor: Determines if this patio unit is allowed to hear a MONITORED intercom station.

Timeout: This determines how long the LED's will remain active on this patio unit following its last use.

Camera Index: This allows a camera to be associated with this patio unit. If a camera is highlighted on an LCD GUI, it will be displayed in an insert window on the Intercom screen when this unit is highlighted.

Room/Zone A,B,C,D: This allows lyriQ Audio Zone(s) to be associated with this intercom unit. If an audio zone is chosen, it will be automatically muted during an intercom call involving this intercom unit.

INTERCOM: LCD CONSOLE SETTINGS:

Intercom LCD Settings - Microsoft Internet Explorer

Address: http://192.168.40.9/intercom_lcd_setup_edit.sh

Main Setup : Intercom Setup : LCDs

LCD Settings

Name: DISPLAY 1

Chime Volume: 50

Monitor Allowed: Yes

Mute Allowed: Yes

Dynamic Sorting: On

Camera Index: None

Select Music Rooms/Zones to mute when this intercom is in use.

Room/Zone A: None

Room/Zone B: None

Room/Zone C: None

Room/Zone D: None

Save Settings Cancel

Unit Name

Intercom settings (see below)

NOTES:

Chime Volume: This is the volume at which a door chime will play at this unit. This can be set to 0 for a location that does not wish to hear the door chime.

Monitor Allowed: If set to No, this intercom unit may not be monitored.

Mute Allowed: If set to No, this intercom unit may not be muted.

Dynamic Sorting: This determines if the unit list for this intercom unit will be displayed alphabetically, or adjusted dynamically based on which units are called most frequently.

Camera Index: This allows a camera to be associated with this intercom unit. The camera will be displayed in an insert window on the Intercom screen when this unit is highlighted.

Room/Zone A,B,C,D: This allows lyriQ Audio Zone(s) to be associated with this intercom unit. If an audio zone is chosen, it will be automatically muted during an intercom call involving this intercom unit.

NOTE: If this LCD Console has a built-in lyriQ add-on board, its location MUST be designated in the Room/Zone A setting. This allows the Music tab to properly control this LCD Console's lyriQ zone.

F. Setup Messages

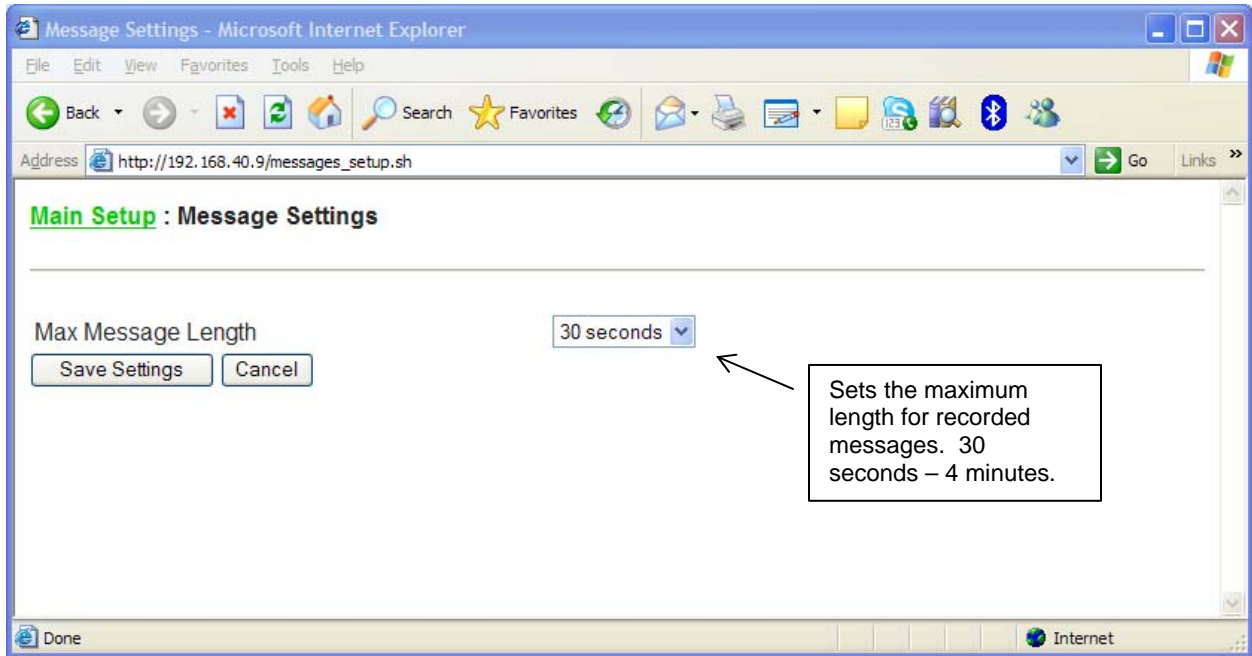

G. Setup Groups

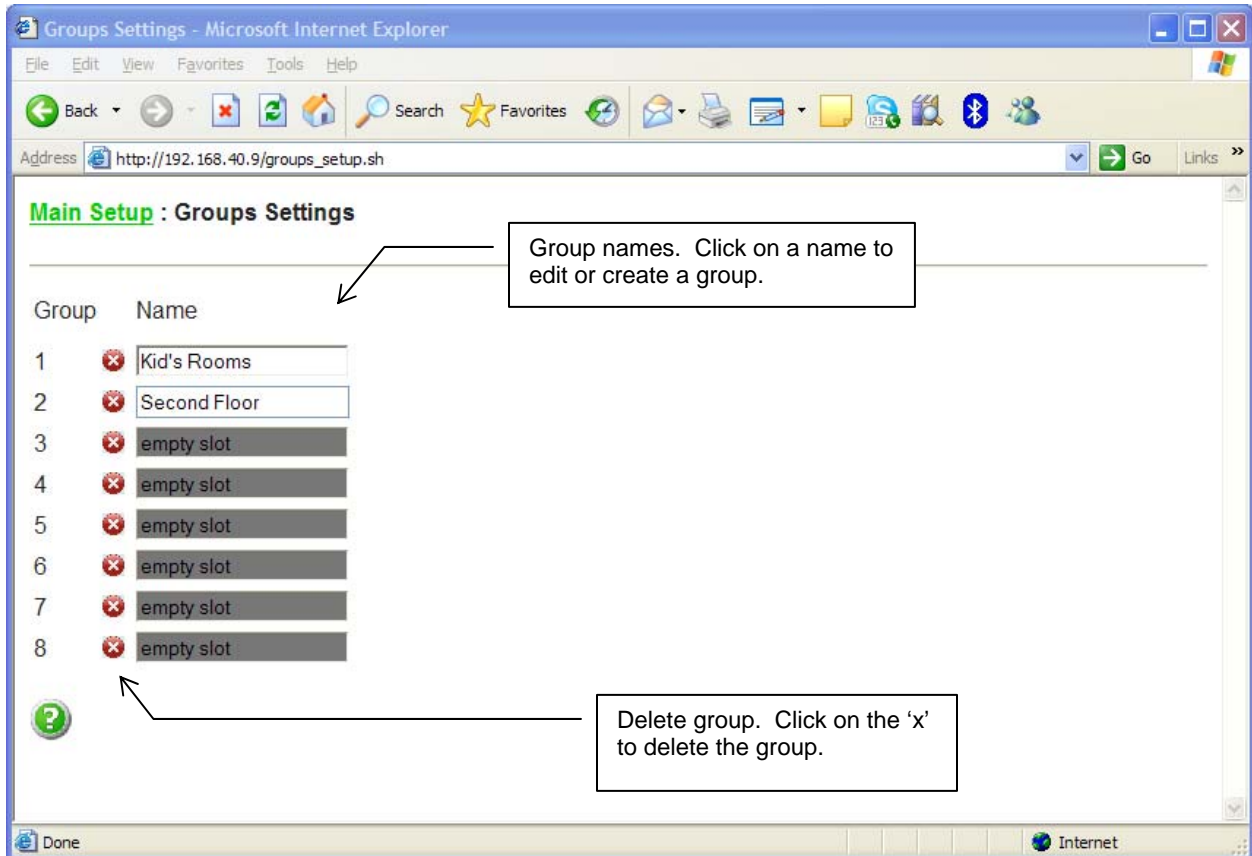

NOTES:

Groups: Groups are a collection of intercoms to make calling easier. For example, putting all the children's rooms in a group called "Kid's Room" makes it easier to call those selected intercoms without bothering the rest of the home.

GROUPS: EDIT/CREATE GROUP:

Groups Settings : Edit Group

Group Name:

Included Units:

<input type="checkbox"/> Matt's room	<input checked="" type="checkbox"/>
<input type="checkbox"/> Kim's room	<input checked="" type="checkbox"/>
<input type="checkbox"/> Master BR	<input type="checkbox"/>
<input type="checkbox"/> Rear deck	<input type="checkbox"/>
<input type="checkbox"/> Front door	<input type="checkbox"/>
<input type="checkbox"/> Kitchen	<input type="checkbox"/>
<input type="checkbox"/> Game room	<input type="checkbox"/>

Group name

Names of all intercom units. Reference only – not editable.

Checkboxes for including the various units in the group.

H. Setup Player

Main Setup : Player Settings

Catalog to find the available digital music on your home network. Catalog can typically find open shares on the network. If your files are not found, or if they are password protected you can enter them below. User Name and Password only required for protected shares.

Ex. Computer named **Max-Dual**
A share on the computer called **Music**
User name of **Unity** (the user account on your Windows or Macintosh OS)
Password (The password of the user account in Windows or Macintosh OS)

Click the Catalog button to begin a new catalog on the system.

Delete group. Click on the 'x' to delete the group.

Fill in Computer Name, Share Name, Username and Password to share music on your home network. Refer to section VII. Unity Network Sharing for more information.

Share	Computer Name	Share Name	Username	Password
1	<input type="text" value="Empty"/>	<input type="text"/>	<input type="text"/>	<input type="text"/>
2	<input type="text" value="Empty"/>	<input type="text"/>	<input type="text"/>	<input type="text"/>
3	<input type="text" value="Empty"/>	<input type="text"/>	<input type="text"/>	<input type="text"/>
4	<input type="text" value="Empty"/>	<input type="text"/>	<input type="text"/>	<input type="text"/>
5	<input type="text" value="Empty"/>	<input type="text"/>	<input type="text"/>	<input type="text"/>
6	<input type="text" value="Empty"/>	<input type="text"/>	<input type="text"/>	<input type="text"/>
7	<input type="text" value="Empty"/>	<input type="text"/>	<input type="text"/>	<input type="text"/>
8	<input type="text" value="Empty"/>	<input type="text"/>	<input type="text"/>	<input type="text"/>

Buttons:

I.Setup Lighting

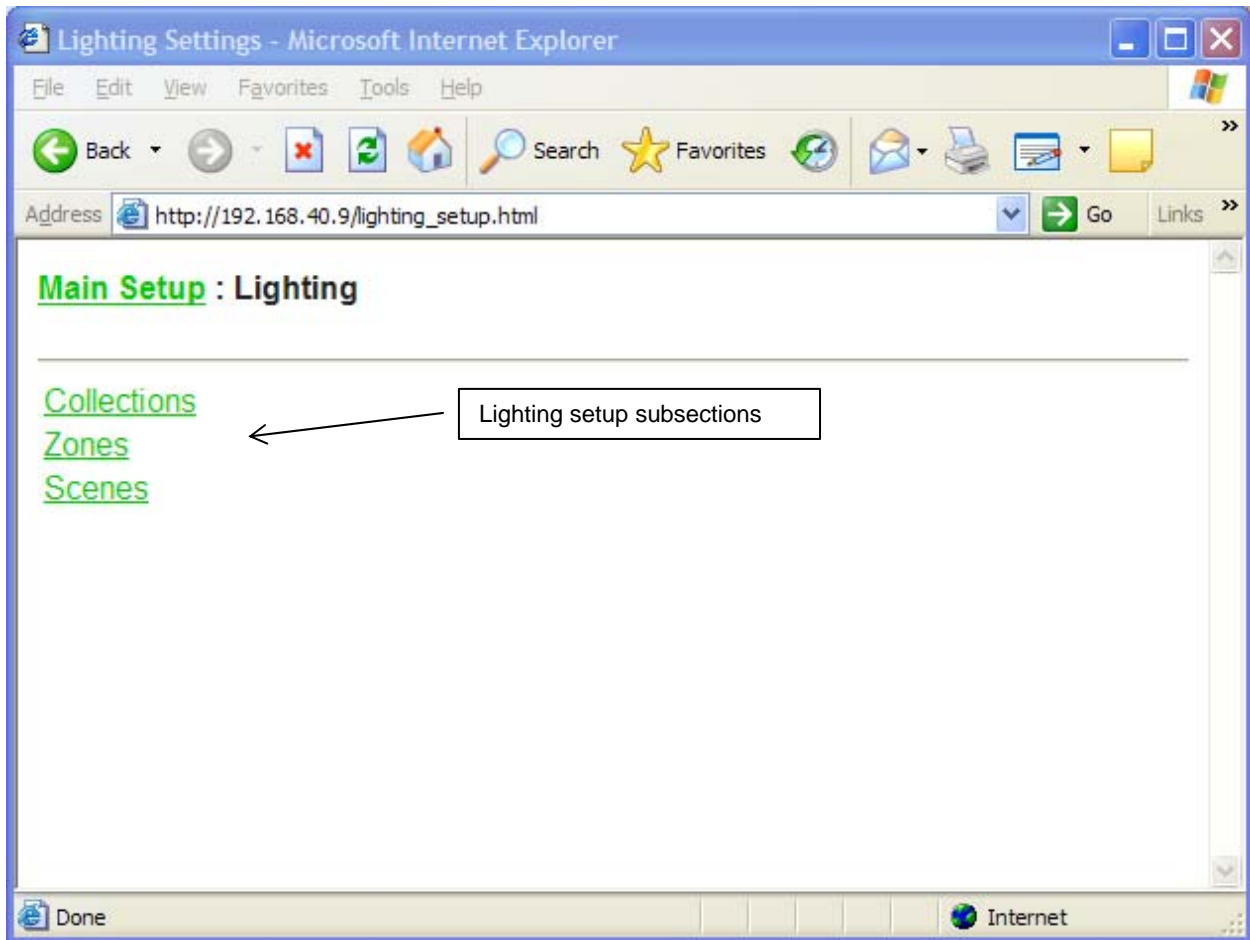

From here, we can pick a specific Lighting subsection to setup:

Collections: allows for grouping several lighting zones into a collection.

Zones: allows for renaming the lighting zones.

Scenes: settings for lighting Scenes. This allows the user to set up specific lighting scenes, such as "party" or "leaving house".

LIGHTING: ZONES:

Lighting Zone Settings - Microsoft Internet Explorer

File Edit View Favorites Tools Help

Address http://192.168.40.18:8580/lighting_groups_setup.sh Go Links >>

Main Setup : Lighting : Zones

Zones

Zone Names

- LR light
- Stair light
- Basement light
- Kitchen light
- office ceiling
- office desk
- garden
- dining room
- outside floods
- outside porch
- outside deck

Save Settings Cancel

Click the target to start the "locating" feature. The selected lighting zone will start blinking to assist in locating and naming. The light will blink 10 times.

NOTES:

Zones: Up to 15 zones can be added to a collection.

LIGHTING: COLLECTIONS:

Lighting Collections Settings - Microsoft Internet Explorer

File Edit View Favorites Tools Help

Back Forward Stop Home Search Favorites Refresh Print Mail News RSS Bluetooth

Address http://192.168.40.18:8580/lighting_rooms_setup.sh Go Links >>

Main Setup : Lighting : Collections

Collection	Name
1	All Outside Lights
2	empty slot
3	empty slot
4	empty slot
5	empty slot
6	empty slot
7	empty slot
8	empty slot
9	empty slot
10	empty slot

Collection names. Click on a name to edit or create a collection.

Delete collection. Click on the 'x' to delete the collection.

Done Internet

LIGHTING: COLLECTIONS: EDIT:

Collection Name

Collection Name: All Outside Lights

Names for all lighting zones. Reference only – not editable.

Name	Include
LR light	<input type="checkbox"/>
LR sofa light	<input type="checkbox"/>
Stair light	<input type="checkbox"/>
Basement light	<input type="checkbox"/>
Kitchen light	<input type="checkbox"/>
Kitchen counter	<input type="checkbox"/>
breakfast room	<input type="checkbox"/>
hallway	<input type="checkbox"/>
office ceiling	<input type="checkbox"/>
office desk	<input type="checkbox"/>
garden	<input checked="" type="checkbox"/>
dining room	<input type="checkbox"/>
outside floods	<input checked="" type="checkbox"/>
outside porch	<input checked="" type="checkbox"/>
outside deck	<input checked="" type="checkbox"/>

Checkboxes for including the various lighting zones in the collection.

Save Collection Cancel

LIGHTING: SCENES:

Lighting Scene Settings - Microsoft Internet Explorer

File Edit View Favorites Tools Help

Address http://192.168.40.18:8580/lighting_scenes_setup.sh Go Links

Main Setup : Lighting : Scenes

Scene	Name
1	Outside Lights On
2	Going to bed
3	Movie night
4	empty slot
5	empty slot
6	empty slot
7	empty slot
8	empty slot
9	empty slot
10	empty slot

Lighting scene names. Click on a name to edit or create a scene.

Delete lighting scene. Click on the 'X' to delete the scene.

Done Internet

LIGHTING: SCENES: EDIT:

Lighting Scene Name

Scene Name:

Names for all lighting zones. Reference only – not editable.

Name	Level	Include
ALL	00	<input type="checkbox"/>
LR light	50	<input type="checkbox"/>
LR sofa light	0	<input type="checkbox"/>
Stair light	100	<input type="checkbox"/>
Basement light	0	<input type="checkbox"/>
Kitchen light	100	<input type="checkbox"/>
Kitchen counter	0	<input type="checkbox"/>
breakfast room	20	<input type="checkbox"/>
hallway	0	<input type="checkbox"/>
office ceiling	0	<input type="checkbox"/>
office desk	0	<input type="checkbox"/>
garden	100	<input checked="" type="checkbox"/>
dining room	50	<input type="checkbox"/>
outside floods	100	<input checked="" type="checkbox"/>
outside porch	100	<input checked="" type="checkbox"/>
outside deck	100	<input checked="" type="checkbox"/>

Checkboxes for including the various lighting zones in the scene.

Lighting level for the individual lighting zones. Note that this is only relevant if the lighting zone is selected for this collection

Save Scene Cancel

J.Setup the System

Main Setup : System Settings

Enter Authorization Code

Auto Clock Set

Enable Auto Clock Set: Yes

Select Time Zone: (GMT-05) Eastern Time

Daylight Saving Time: Yes

DST	Week	Day	Month	Local Time
Begin	Second	Sunday	March	2:00 AM
End	First	Sunday	November	2:00 AM

Set DST Default Values

Manual Clock Set [Disabled by Auto Clock]

Time (hh:mm) 11 : 40 AM

Date (mm/dd/yyyy) 09 / 14 / 2010

Save Settings Cancel

Done Internet

Press this button to be taken to the Authorization Code screen. This allows 'unlock' codes to be entered for optional Unity features.

Allow for Unity clock to be set from the internet.

Local time zone

Is Daylight Saving Time observed?

Defines when DST begins and Ends. Most locations (United States) will use the Default Values. Other areas may need to adjust from the defaults.

If "Enable Auto Clock Set" is set to No, this allows for manual setting of the Unity clock.

SYSTEM: AUTHORIZATION CODES:

Authorization Code Entry - Microsoft Internet Explorer

File Edit View Favorites Tools Help

Back Forward Stop Home Search Favorites Refresh Mail Print Mailbox RSS Bluetooth

Address http://192.168.40.9/auth_code_setup.sh Go Links >>

Main Setup : System Settings : Authorization Code Entry

To unlock a feature, enter its authorization code below.

Authorization Code

Save Codes Cancel

Done Internet

Allows for entering Authorization Codes. These will "unlock" Unity features for beta users or non-standard options.

K.Find Firmware Info

Main Setup : Firmware Info

Name	Address	Version
IM	10:0014	v2.2b100
Matt's room	90:1ABF	v1.4
Kim's room	90:3731	v1.4
Master BR	90:8316	v1.4
Rear deck	94:276D	v1.0
Front door	95:087F	v1.0
Kitchen	AC:0002	v1.3
Game room	AC:1234	v1.2
	C0:64AB	v0.0a0

Displays Names, Addresses, and Firmware Versions for all Unity components in the system. This is for diagnostic information only – none of these fields are editable. Note that Studio Cameras (addresses beginning with C0) do not show any names.

L.Setup Weather

Main Setup : Weather Settings

Enter Zip Code or City,State (City,Canada for Canada)

17057

Check

Save Cancel

Enter zip code (US) for desired location
OR
City, State (for example, Hershey, PA)
OR
City, Canada (for example, Montreal, Canada)

Click to check if weather data is available for this location. If the location is found, the field will change to a green background.

M.Setup Internet Radio

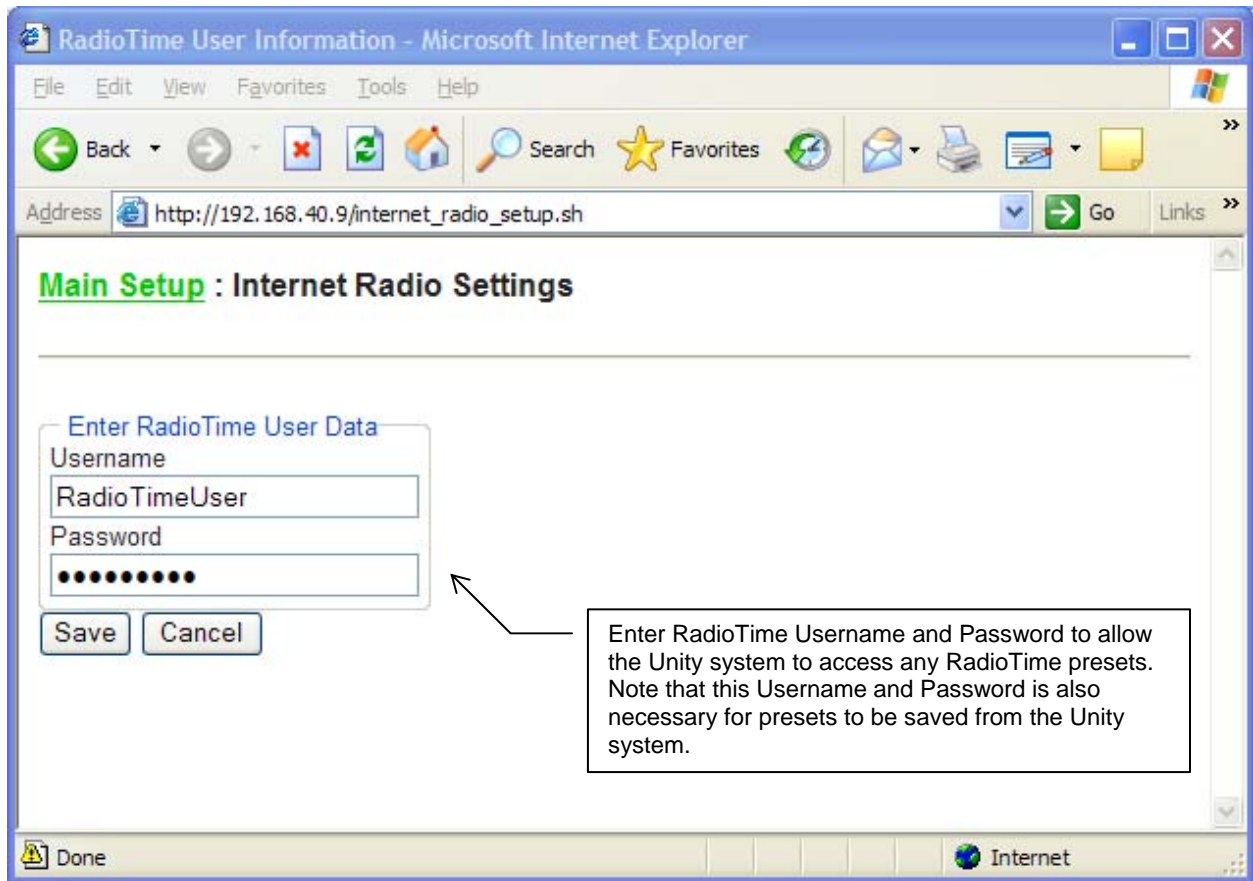

N. Unity System Setup Guide for LCD ONLY Options

Some features of the Unity System may ONLY be setup on a Unity LCD Console. These features are described in detail below.

1. Custom Door Chimes:

Unity may be configured to use Custom Door Chimes(CDC) for Intercom Door Units throughout the home. There are 10 slots reserved for CDC. These slots, numbered 21-30, will appear in the regular Door Chime selection box if recorded (i.e. If CDC 21 is recorded with a Christmas themed song, and CDC 22 is recorded with a New Years themed song, the selection box for a door chime will now cycle through all 20 default chimes, as well as CDC 21 and CDC 22). Follow the steps below to set up a CDC.

Enter Setup -> Intercom -> Custom Door Chimes. The screen below will be displayed. This is the main screen from which all CDC will be displayed and recorded.



Pressing Talk/Select on an Empty or Blank line will create a new CDC for that slot. Pressing Talk/Select on an already recorded CDC will rerecord that chime.

Either selection will lead to the following screen where an individual CDC may be set up.



There are two types of CDC: Song Based and Message Based.



To select a Song Based CDC, use the Up and Down arrow keys to highlight the Chime Type selection box. Next, use the Left and Right arrow keys to change the type to Song Based. Softkey 3 ('Song') will now be activated. Pressing Softkey 3 will open the player menu selection screen. This screen may be navigated just like regular Player function. Using these menus, select the desired Song to be used for the CDC. This will bring up a screen very similar to the Now Playing screen. Softkey 4 is used as a Start/Stop marker or a Begin/End marker to designate which portion of the current song will be used for the CDC. As the song plays, use Softkey 4 to place a Start marker and a Stop marker and press Softkey 3 (Done) when finished. While setting the markers for the song, just as in normal Player function, the Left and Right arrow keys may be used to move forward and back in the song itself, in order to find the correct spot to place the Start/Stop markers.

To select a Message Based CDC, use the Up and Down arrow keys to highlight the Chime Type selection box. Next, use the Left and Right arrow keys to change the type to Message Based. Pressing Softkey 3 (Record) will open the record screen. This screen behaves exactly like any other Unity message recording screen. Pressing Talk/Select will begin recording. Pressing Talk/Select a second time will end the recording. When finished, press Softkey 1 (Done). This will save the message to the current CDC.



2. Door Messaging:

Unity has a feature that allows visitors to leave a message at the Unity Door Unit when nobody is home to answer the door. To use this feature, first it must be enabled, and then optionally a custom door message may be added. This feature is very similar to an answering machine for the Door Unit.

To enable the feature, navigate to Setup -> Intercom -> Door Options and select the Door Unit for which the message will be set up.



In the Door Settings list, navigate down to the Door Messaging list item. Use the Left and Right arrow keys to enable this feature (i.e. The box should say 'Yes'). Press Done to get back to the list of Door Units. Repeat this process for all Door Units that will have a Door Message.

Once Door Messaging is enabled for all desired Door Units, press Done to exit Door Options, and press Done once more to exit Intercom Options.

Next, a custom door message may be recorded (Note: This step is optional. If not completed, the default message will play. If this step IS completed, first the custom message will play, and then the default message will follow). To record a custom message, navigate to Setup-> Messages.



With Door Messaging now enabled, one extra setting and two extra line items will appear in the list. The max door messaging length can be set so any one door message does not exceed a certain time (30 sec, 1 min, 2 min, or 4 min). The following two list items are for recording and preview of the custom door message. Pressing Talk/Select over Record Door Prompt will show the basic Unity Message Recording screen. In this screen, a single Talk/Select press will start the message recording, and a second will Stop message recording. Once the message is recorded, press Done. To preview the message, press Talk/Select over Play Door Prompt. When finished recording the custom door message, press Done.

3. Lighting – Performing an RF Scan:

The Unity System will discover properly attached RFLC lighting control devices (Dimmers, Switches and Fan Controllers) during the Boot-Up sequence. But, it is possible to discover RFLC devices without powering down the HA6001 module. This can be done from the HA6001 G.U.I. (LCD or TVDI) by going to Setup -> Lighting and selecting “RF-Scan”.

RFLC devices previously found by the HA6001 module will not be removed from the HA6001 G.U.I. (under Lighting), even if the device has been removed from the Lighting control system. RFLC devices must be removed manually from the HA6001 G.U.I. (LCD or TVDI) by going to Setup-Lighting-Zones and selecting “Delete” (described in more detail below).

Activating a Lighting Device (bound to the MR232) will also cause it to be found by the Unity system. This may be useful if an RF-Scan does show all device addresses bound to the MR232.

IMPORTANT: Addresses that appear on the Unity system, but do not control any Lighting device in the home, are often the result of Group binding that occurred after the HA6001 was powered on. It is advised to Delete these addresses and perform an RF Scan to remove these devices, as they are no longer valid addresses to the Unity system.



4. Lighting – Delete a Zone:

Unity Lighting Setup offers a special function to delete a single Lighting Zone. This may be necessary under certain circumstances (e.g. Reconfiguration of Unity Lighting, removal of a Unity Lighting Zone, etc). The procedure for doing this is listed below.

Navigate to Setup -> Lighting -> Zones. This screen displays a list Unity Lighting Zones currently in the system.



Pressing Softkey 3 (Delete) from this list will remove the current zone from the list of Unity Lighting Zones. There are several things to keep in mind when deleting a Unity Zone: This will remove a zone AND its associated zone name, neither of which are recoverable. If the zone still exists in the system, it WILL show up again. The name association however will be removed. This means a group number may show up again, but NOT the name previously assigned to it.

If a zone repeatedly appears in the list after being deleted, and it should NOT be there, consult the trouble shooting section or contact technical support.

5.Setup – Thermostat:

When the Thermostat interface has been activated, the user will see the Thermostat icon on the main wheel:



In addition, there will be a Thermostat setting item under Setup:



The Thermostat sub-menu will have two options:



Choose Schedules to adjust daily schedules.

Choose Thermostat Settings to change number and addresses of thermostats.

The Schedule screen allows for individual settings for 4 time periods for each of the seven days in the week. Each HVAC system can use a unique schedule program, so a screen is provided to choose the appropriate thermostat:



Subsequently, the schedule for the chosen thermostat is presented:



The user is allowed to select the day (Sunday through Saturday), the Period (Morning, Day, Evening, Night), the Time that this period starts and the Heat and Cool Setpoints for this period.

Note that this is the same information that is settable from the thermostat interface.

For the Thermostat Settings sub-menu, the user is allowed to set the address for multiple Thermostats in the system. These addresses must match the addresses from the individual Thermostats.

V. Technical Troubleshooting

A. Unity Module is not able to discover music – Improper configuration of Windows Sharing is the most important element that will prevent music from being discovered on the network. Please see Section VII. (Unity Network Sharing) for proper configuration instructions. If those steps have been followed, see the following links for further aid from Microsoft's knowledge base on sharing setup for the most commonly used version of Windows:

Windows XP Sharing Setup: <http://support.microsoft.com/kb/304040>

Windows Vista File and Printer Sharing Setup: <http://technet.microsoft.com/en-us/library/bb727037.aspx>

Windows 7 File and Printer Sharing Setup: <http://windows.microsoft.com/en-US/windows7/File-sharing-essentials>

Mac OSX: <http://support.apple.com/kb/ht1549>

It's important to verify that there are no software firewalls running in the background that could possibly prevent the Unity module from locating the proper shares on the computer. If verification is needed that the shares on the PC are setup properly, there is a software download that can be used for that purpose called ShareEnum. That can be downloaded from the following link:

ShareEnum v1.6: <http://technet.microsoft.com/en-us/sysinternals/bb897442.aspx>

Note that work computers connected to a domain will almost certainly not function due to their settings. We do not support computers that connect to work domains.

Finally, it is important to verify that the Unity module is not installed on a system that has multiple DHCP devices (ex. two routers, etc.). If that is the case, the Unity module needs to be on the same subnet as the PC with the shared files. An easy way to verify that is to enter the web setup for the Unity module from the PC where the music files are stored. For instructions on how to enter web setup, see Section IV. (Setup Guide for Web and LCD Console).

B. Unity Module is unable to boot up properly (LCD's have black screens, no GUI's) - There are various causes for boot up problems with the Unity Module. It is important to both understand what you should be seeing on the LCD screens during the boot up procedure as well as allow the module the time it needs to properly initialize and arrive at the user interface. See Section III. Sub-section N. (Boot Sequences) for further information on system initialization and boot up.

If the module is still not booting up properly within 5-7 minutes, check the following:

- Verify the Router functionality. Connect a computer directly to the router and verify that the computer is pulling a proper DHCP address from the device.
- Verify the SD Card located underneath the module is situation properly in the SD Card slot.
- Verify that both LAN connections are plugged into a DHCP enabled Router. **Both LAN port connections are required!**
- Power off the module and disconnect all units from the module. Connect only the two LAN port connections and one LCD/TVDI. Power the system on and allow the boot up procedure to complete. If the system boots up, there may be a wiring problem to a specific unit that is causing the system to not initialize. Start by plugging in one unit at a time (LCD, SCI intercom units, etc.) making sure to power off the Unity Module before plugging or unplugging any units on the system. If the module still does not initialize, please contact Technical Support.

C. *The Unity System has locked up (no ability to navigate GUI)* - If the Unity System has been functional for an extended amount of time and suddenly freezes, the symptoms could include:

- No movement for the bubbles in the background.
- No ability to navigate the GUI using the directional arrows on the LCD or the directional arrows on the AU1060 Universal Remote when using a TV Display Interface.
- Selective Call Intercom Units are frozen and cannot be used to communicate.

The most effective solution to any system freeze is to simply recycle the power on the Unity Module and any expansion modules connected to the system. If the system remains frozen, please contact Technical Support.

D. *“Unit Not Discovered” Error Message Appears on the Selective Call Intercom Units* - This is a normal error message that will appear across all Selective Call Intercom Units that are plugged directly into the Unity module. It is part of the regular boot-up procedure. The error should disappear within the 5-7 minute system boot-up period.

If this error message persists after the initial boot up process, verify that the LCD/TVDI's on the system have arrived at the GUI. If not, follow the troubleshooting steps in the section labeled ***“Unity Module is unable to boot up properly”***.

E. *“Address Jumpers Incorrect” Error Message Appears the Selective Call Intercom Units* – This is a normal error message that will appear across all Selective Call Intercom Units that are plugged both directly into the Unity Module and across any Selective Call Intercom expansion distribution modules. It is part of the regular boot-up procedure. The error should disappear within the 5-7 minute system boot-up period.

If the error message persists, check the following:

- Verify the addressing of the Selective Call Expansion Modules. The Unity Module is considered the “Master” module on the system so it’s important that any expansion modules added are set to the proper slave configuration.
- Make sure the Unity Module is being powered on prior to or at relatively the same time as the expansion Selective Call Intercom Modules. Ideally, the Unity Module and expansion modules should be powered on at the same time via a multiple connection power strip.

If the problems continue, please follow the troubleshooting steps in the section labeled **“Unity Module is unable to boot up properly”**.

F. Camera images not appearing when entering the “Camera”

menu – Troubleshooting will vary dependant on whether the camera expansion is being done on the system or not. The proper steps to follow:

Without Expansion:

- Verify and test the wiring to the Ball Cameras connected directly to the Unity Module
- Make sure that no bullet style cameras are being connected to the Unity Module. **Bullet cameras such as the F2299, F2284, F2287 and the F2286 cannot be connected directly to the camera ports on the Unity Module!**

With Expansion:

- Verify and test the wiring between the expansion CM1010 LCD Module and the Unity module. **Two wires are required from both the Camera 1 and Camera 2 ports on the Unity Module to the first and second port on the LCD Module!** Please refer to Section III. (Unity System Installation Information) – sub-section H. (Connecting the Cameras) for further information on how to expand the number of cameras that can be used on Unity.
- Verify and test the wiring to all cameras installed on the system.

G. Not able to access the “Music” menu -

- Verify and test the wiring between the Integration 1 and Integration 2 port of the audio module being used (AU1002 or AU1014) and the Audio 1 and 2 ports on the Unity module. **Both wires are required for proper communication!** Please refer to Section III. (Unity System Installation Information) – sub-section F. (Connecting the lyriQ Audio System) for further information on how to properly wire lyriQ to the Unity module.

H. Some lyriQ Volume controls are not appearing in the “Music”

menu – Troubleshooting steps can vary dependent upon whether a single source or multisource system is installed. General troubleshooting steps to follow:

- Reset the lyriQ keypad that is not appearing to factory defaults (Refer to IS-0420 or IS-

0425 (HP) for instructions). This will verify that the whole house command function is enabled and functioning properly. The ability to see whole house commands is essential to proper communication with the Unity Module. Once the keypad has been reset, it may be necessary to enter and exit the “Music” menu 3-5 times before the keypad does appear.

- In a single source configuration with a 4 zone distribution module, it is important to verify the “Grouping” settings in the individual lyriQ keypads setup menus (Refer to IS-0420/0425 for instructions). In this configuration, one keypad would need to be set as the “Group Master” and the other three keypads would need to be set as the “Group Member”. The same setup applies to any 4 zone distribution module being used to expand a multisource system.

- Verify and test the wiring to lyriQ keypads. It may be necessary to move the lyriQ keypad to the audio module and connect it directly to the device to verify proper functionality.

I. *Intercom Units not appearing in the “Intercom” menu –*

- Verify and test the wiring to Selective Call Intercom Unit not appearing on the “Intercom” Screen. It may be necessary to move the Intercom Unit to the Unity Module and connect it directly to the device to verify proper functionality.

- From the home screen on an LCD connected to the Unity Module:

- Navigate to the “Setup” menu and press “Talk/Select”

- Scroll down to the “Firmware Info” menu selection and press “Talk/Select”

- All Selective Call Units and LCD’s connected to the system will be listed in this menu

- Verify that there are no duplicate addresses listed in the middle column

- Verify that all Selective Call Intercom Stations on the system are running v1.4 firmware

If there are discrepancies in the version of firmware being run on the units or duplicate addresses are found, please contact Technical Support

J. *Events not triggering in sequence or not triggering at all –* Events

will not be triggered in sequence and are not based on any timing delay. If four actions are programmed as part of an event, those actions will all trigger at relatively the same time. It is important to remember this when programming an event.

If an action or multiple actions are not triggering, select the edit option and test each action individually. Set the action to trigger at a specific time and verify it works. This will help to insure one action is not causing the other actions to fail.

K. RF Lighting – Lights not appearing in the “Lighting” menu –

-Prior to triggering an RF scan (see Section III. (Unity System Installation Information) – sub-section K. (Connecting RFLC) for instructions), verify that the house binding for all of the RF Lighting devices has been completed.

- Verify the RS232 adapter is wired properly. Use a standard RJ45 connected to a DB9 adapter for connectivity. The RJ45 will plug into Serial 1 on the Integration Module (Serial 2 will not work!). The DB9 will plug into the serial connection on the MR232. The following is the proper pin layout that must be followed for the communication to work:

RJ45 -> DB9
Pin 3 -> Pin 3
Pin 6 -> Pin 2
Pin 5 -> Pin 5

L. Weather not pulling up data or showing out of date Weather –

Canadian Zip Codes are not supported by the Unity Module. To pull proper weather information for Canada, the city name must be entered in full. For the United States, only the Zip Code is required.

The “Weather” menu is updated at 7am, 10am, 1pm, 4pm, and 7pm EST. The current conditions are updated every half hour. After 7pm EST, the “Weather” menu will no longer update until 7am EST the next morning.

M. Updating the Unity Module is not working –

-Verify proper internet connectivity from a computer connected to the same Router the Unity module is connected to. It is helpful to test all ports on the device including the two ports the Unity Module is currently connected to (see Section III. Sub-section N. 2. for full instructions on updating).

- If the Unity Module is still not able to update, please contact Technical Support.

N. Not able to access Web Setup –

- See Section IV. (Setup Guide for Web and LCD Console) for instructions on how to find the proper IP address to use to access the Web Setup menu for the Unity Module

-Verify the computer that is being used to access the Web Setup menu is on the same IP subnet as the Unity Module.

Example:

-If the Unity Module has a Web Setup IP address of 192.168.40.8 and the computer has an IP address of 192.168.1.10, the computer will not be able to resolve that subnet and therefore will not allow access to the Web Setup menu. This can occur when there is more than one DHCP device handing out IP addresses on the network. This is common when more than one router is connected together.

If multiple DA1004 routers are being used, the solution to this issue is to set the routing switch to off on one of the routers which will disable the DHCP functionality of that device. Use a CAT5 jumper cable to connect from any of the 4 LAN ports of the first router into any of the four LAN ports on the secondary router that's been converted into a switch.

For third party routers, please contact the router manufacturer for instructions on how to disable the DHCP functionality of the device.

VI. Unity User's Guide

This section describes the basic usage techniques to successfully navigate and enjoy a Unity System along with specific walkthroughs of the individual Unity functions.

A. Basic Navigation:



Above is a description of the various buttons on the front of the Unity LCD Console. Each softkey corresponds to the tab shown directly above it in the display. Similarly, the compass keys correspond to the associated arrow indicators shown in the display. For instance, in this particular screen, the left and right compass keys would move the Icon Wheel to the left or right accordingly.

To navigate throughout the Unity System, from the main screen shown above, use the Left and Right compass keys to spin the icon wheel, and then use the Talk/Select button to choose the desired function. Alternatively, use the softkeys to choose the shortcut to the desired function. The Home softkey will always bring the Unity system back to this main screen. Pressing the Home key a second time will center the Icon Wheel on the Intercom icon. The power button will put the current display into standby mode. The display will be automatically activate if it is ever the target of an intercom call (including an ALL call and/or Door Event). To prevent this, place the unit in standby then press the mute button.

B. Unity Functions:

The following is a list of walkthroughs on using each function of the Unity system.

1. Using the Intercom



To enter the Intercom function, use the Left and Right compass keys until the Icon Wheel is over the Intercom Icon, and then press Talk/Select . A list of intercom units should be displayed.

Basics

As indicated on the display, the Up and Down compass keys will move the highlight box. To call an intercom unit, highlight that unit, then press and hold the Talk/Select button. The Unity Intercom is a 'press and hold' intercom. This means to make an intercom call, the Talk/Select button must be HELD when talking TO the highlighted unit. When the Talk/Select button is released, the highlighted unit will have a number of seconds (15 seconds by default, but adjustable in Settings -> Intercom) to respond in what is called 'talk hands free' mode. During this mode, the unit being CALLED may respond to the CALLER without any specific intercom interaction. After talk hands free mode times out, the intercom will return to the state it was in upon entering the intercom screen. An audible tone will sound to indicate the transition between the states mentioned above. A typical intercom conversation will go as follows:

- User presses (and holds) Talk/Select
- A tone sounds to indicate it is OK to start talking
- User talks TO selected unit
- User releases Talk/Select
- A tone sounds to indicate transition to 'talk hands free' mode
- Selected unit has some number of seconds (15 seconds default) to talk BACK to caller
- A tone sounds to indicate end of conversation



Monitor

Pressing softkey 3 will place the unit into monitor mode. When a unit is in monitor all other units on the system will be able to hear it.

Send Message

Pressing softkey 4 from the intercom menu will open the messaging menu.

From this menu, messages may be sent to one, many, or all other intercom units. For full information on sending messages, please refer to the Using Messages section of the Unity Users Guide.



2.Using the Player

To enter the Player function, use the Left and Right compass keys until the Icon Wheel is over the Player icon, and then press Talk/Select. The player menu should be displayed. The following sections describe the individual player sub menus. In general, the Up and Down compass keys are used to navigate the current menu, and Talk/Select is used to select the current menu item (either bringing up another sub menu, or redirecting to Now Playing).



Playlists

Selection chain:

- Playlists – list of playlists.
- Specific playlist – list of songs on playlists.
- Song – leads to Now Playing

Clicking Playlists will display all playlists that have been cataloged by the Unity system. Selecting a specific playlist from the list of playlists will display all songs on that playlist. Selecting a song from that playlist will play the song and lead to the Now Playing screen.



Click Playlists

List of playlists



List of songs on playlist



Selection chain:

- Songs – list of songs.
- Specific song – leads to Now Playing.

Clicking Songs will display a list of all songs cataloged by the Unity system. Clicking on an individual song will play that song and direct the display to the Now Playing screen.

At any time (i.e. in any Player sub menu), softkey 3 will open up an alphabetic search window. The cursor keys and talk/select button operate the mini keypad. The search is incremental, meaning that any letter that is input will further narrow the search. To close the box, press softkey 3 again. The alphabetic search box will ONLY search in the current sub menu. For example, if the current sub menu is Songs, the alphabetic search box will narrow down the Songs list based on the characters input. If the current sub menu is Artists, only the Artist list will be narrowed down. It will still be necessary to select an artist to view Albums and Songs by that Artist.

Full Songs List



Alphabetic search



Artists

Selection chain:

- Artists – list of artists.
- Specific artist – albums by artist.
- Album – songs on album.
- Song – leads to Now Playing.

Clicking Artists will display a list of artists currently cataloged. Clicking a specific artist will display a list of Albums by that Artist. Clicking an album will display songs on that album. Clicking a song will lead to the Now Playing screen.

Artists



Albums by artist



Songs on album



Albums

Selection chain:

- Albums – list of albums.
- Specific album– songs on album
- Song – leads to Now Playing.

Clicking albums will display the list of albums currently cataloged by the Unity System. Clicking a specific album will display the list of songs on that album. Clicking a song will lead to the Now Playing screen.

Albums



Songs on album



Genres

Selection chain:

- Genres – list of genres.
- Specific genre– albums in genre.
- Album – songs on album.
- Song – leads to Now Playing.

Clicking on Genres will display the list of genres currently cataloged by the Unity system. Clicking on a specific genre will display a list of albums in that genre. Clicking on an album will display a list of songs on that album. Clicking on a song will lead to the Now Playing screen.

Genres



Albums in genre



Songs on album



Now Playing

The Now Playing screen displays the information for the current track. This information includes artist, song, album, and a time progress bar. The Up and Down compass keys will go to the previous and next song in the song list respectively (reference note below).

Softkey 1 will return to the screen the GUI was at immediately before entering the Now Playing screen.

Softkey 2 will cycle between Normal, Shuffle, and Loop modes for song order.

Softkey 3 will stop the player.

Softkey 4 will toggle pause/play for the player.

NOTE: The player will continue to play through songs from a LIST using some play MODE. The play MODE is determined by softkey 2. The LIST is determined by where the song was selected from. For instance, if the song was selected through Artist -> Album -> Song then the LIST would contain all songs from that album by that artist. If the song was selected through Playlist -> Song then the LIST would contain all songs on that playlist.



3. Playing Music



Basics

Pressing Talk/Select on the Music icon will open the Unity Music menu. This menu is used to control all lyriQ functionality connected to the Unity system. The Unity Music menu contains 3 tabs if the current LCD Console has no add-on lyriQ capabilities or 4 tabs if the current LCD Console has add-on lyriQ capabilities. The tabs are described below. (Note: To navigate between tabs, use the Left and Right compass keys.)

IMPORTANT: To see the 4 tabs (i.e. the FIRST tab shown below), two conditions must be met. First, the LCD Console must have add-on lyriQ support. This would be indicated by a small music note to the left of the volume light indicators. Second, the lyriQ zone built into the LCD Console must be associated with the Console in Setup -> Intercoms -> LCD Options. For more information on this association, refer to the Unity Setup information regarding LCD Consoles.



The leftmost tab contains the add-on Lyriq information. This tab will only appear if the current LCD Console has built in Lyriq.



The second tab contains a list of all Lyriq audio zones in the system, along with their status and control.



The third tab contains a list of sources attached to the system. This tab is used to switch individual units to a specific source.



The rightmost tab contains a list of lyriQ audio scenes. From this tab, new scenes may be created or edited, and existing scenes may be executed.

Add-on lyriQ tab



The add-on lyriQ screen gives the user the following options. Softkey 1 will toggle the local lyriQ add-on board on and off. Softkey 4 will toggle the local lyriQ add-on boards Mute on and off. Softkeys 2 and 3 will adjust the volume up and down respectively. The up and down compass keys will adjust the source of the local add-on board.

By-Room tab

The By Room Tab is used as a main control/status screen for any lyriQ unit connected to the system.



Softkeys 1 and 4 control power and mute respectively, and the current status regarding these two buttons may be found in the Status column of the zone list. Softkeys 2 and 3 control the volume of the highlighted unit. The volume of a particular unit is indicated by both the number and colored bar in the Volume column of the zone list. Selecting a specific zone will give the following screen:



From this screen the user can set a source, volume, and status for the selected unit. The Up and Down compass keys will change the highlighted section while the Left and Right compass keys will adjust the currently highlighted section.

By Source tab



The By Source Tab lists all sources available for lyriQ source selection. Clicking on a particular source will lead to a list of lyriQ zones connected to the system. From this screen the user may choose to switch one, many, or all zones to the selected source.

Scenes tab



The Scenes tab contains a list of all lyriQ Scenes in the Unity system. A scene may be executed to perform batch control operations for the lyriQ system. For instance, a scene named Party may contain the following commands: Turn on every lyriQ zone in the house except for the baby's room, set all zone volumes to 35%, and set all zone sources to source 4 (which could be a CD Player, for instance). From the main Scenes tab the user may Rename, Delete, Create, or Edit a scene using softkeys 1-4 respectively. To create a new lyriQ scene, follow the procedure below.

Clicking softkey 3 above will lead to a virtual keypad screen. Here the user may name the scene. The compass direction keys control the square highlight box while the Talk/Select key enters a letter. Pressing softkey 2 will delete a letter (backspace), while softkey 3 will toggle the keypad between upper and lower case letters. Once the name is entered, softkey 4 will accept the name and move on to the zone selection screen. At any time softkey 1 may be pressed to cancel the scene creation.



Upon entering a name, the zone selection screen appears. This screen should be set up so that it reflects the exact desired state of the Lyriq system when the scene is executed. This means the user should do the following for each zone:

- Press softkey 2 to include or exclude the unit from the system. If a check is shown in the box to the right side of the highlight bar, that means the unit will be commanded to do something upon scene execution.
- Press Talk/Select over each included zone and set volume, source, and status accordingly.

Once scene setup is completed, press softkey 4 to save all changes.

Note: As an alternative to setting the state of each zone individually during scene creating, the user may put the Lyriq system in the desired state for the scene before creating the scene. When this screen appears, the state of the system will already be correct. The only necessary step in this case in the inclusion/exclusion of zones.



4.Creating Events

Basics

Pressing Talk/Select on the Events Icon will lead to the Unity Events menu. From this menu, Unity Events can be created. A Unity Event is composed of a series of actions the Unity system will perform, at some frequency, at some time in the future. For example, an event may be created to turn on the outside lights every day at sunset. This is only one example of a Unity event. Unity events may be set up for the following types of actions:

- Lighting Scene
- Music Scene
- Player Shuffle
- Player Function
- Play Message
- Send Message



Up to four actions of the types listed above may be set to activate for a single Unity event. To create an event, follow the steps listed below.



Press softkey 3 over an empty slot to create a new event.



In the virtual keypad screen, type the name for the new event. Press softkey 4 to accept the name.



Select the first time this event will happen. Use the compass Up/Down keys to adjust each field and the compass Left/Right keys to switch between fields. Press softkey 3 (Next) to continue.



Choose the frequency this event will occur. For instance, a reminder for a specific task may only occur once, whereas a reminder to pay a bill may occur monthly. Press softkey 3 (Next) to continue.

From this screen, actions are added to events. The Left and Right compass keys are used to select the action type while the Up and Down compass keys are used to move on to the next action. Once an action type is chosen, press softkey 3 (Next) to move on to the specific setup for the associated action type. The action types and their specific setup are described below.



To choose the Audio Scene action type, use the Left and Right compass keys to navigate to 'Audio Scene' and press softkey 3 (Next). A list of all Audio Scenes currently in the Unity system will appear.

Note: To use an Audio Scene for an action in a Unity Event, first the Audio Scene must be created under the Unity Music function. For instructions on how to do this, refer to the section labeled Unity Music Scenes.

Choose the scene to associate with this action. This scene will be performed whenever the event triggers. Once selected, the action selection screen will be displayed again, this time with the appropriate audio scene listed to the right of the Audio Scene action type designator.





To choose the player function action type, use the Left and Right compass keys until 'Player Function' shows in the highlight box and press softkey 3 (Next).



Next, choose the song which will begin to play when this event triggers. For instructions on how to navigate through all Unity Player menus, refer to the Unity Player section.



Pressing Talk/Select at the lowest level of a Player menu, in this case, will select the song for the event. The event will start the song playing on Source i in whichever play mode the Unity Player is currently in.



The song name will now appear to the right of the Player Function action type designator. NOTE: After the initial song plays, all songs continue to play in list order.

To choose the Lighting Scene action type, use the Left and Right compass keys until 'Lighting Scene' appears in the highlight box. Press softkey 3 (Next) to continue. Next will be displayed a list of all Unity Lighting Scenes currently in the system.

Note: To choose a lighting scene for a Unity Event action, that scene must have already been created under Unity Lighting. For instructions on how to do so, refer to the Unity Lighting portion of the guide. Press Talk/Select to choose a lighting scene to associate with the action. Once a scene is chosen, the Unity Event action screen will be displayed again, this time with the chosen lighting scene displayed to the right of the Lighting Scene action type designator.





To choose the Send Message action type, use the Left and Right compass keys until 'Send Message' appears in the highlighted box.



A list of Unity Intercom units will appear on the screen. Use the Up and Down compass keys to select the unit(s) the message should go out to upon trigger of the event.



Press the Talk/Select button to start recording the message. Press Talk/Select once more to finish recording the message and save it to the action.



The action list will now appear again with the destination of the send message action listed to the right of the Send Message action designator.



Pressing softkey 1 (Done) from the Event Action list at any point in the above procedure will finalize the event. The display will show the list of events with the newly created event at the end of the list. It is not necessary to have all 4 action slots in an event filled. An event may contain 1-4 events. The two event action types not discussed above are the Player Shuffle action type and the Play Message action type.

The Player Shuffle action type is almost identical to the Player Function action type. The difference between the two comes when the event is triggered. When a Player Shuffle event is triggered, the Unity Player will play the selected song on Source i and automatically put the Player into shuffle mode.

The Play Message action type is almost identical to the Send Message action type. The difference between the two comes when the event is triggered. The Play Message action type will play the message immediately, at the units designated during the event action setup. The Send Message action type will send the message to the units designated during the event action setup, but the message will not be played until the user initiates a play from one of those units.

5.Using the Thermostat



Pressing Talk/Select while the icon wheel is over Thermostat will open the Unity Thermostat menu. This menu displays current temperature conditions and allows control of Unity compatible thermostats.

The Unity Thermostat screen has two modes described below:

Run mode displays the current temperature and outside temperature. It allows the user to change the heat and cool set points using the Up and Down compass keys.

Softkey 1 will cycle between the connected thermostats. (Unity may have up to 3 connected thermostats.)

Softkey 2 will toggle between Heat, Cool, and Auto.

Softkey 3 will toggle the fan On and Off.

Softkey 4 will put the thermostat in Hold mode.



Hold mode displays the temperature and outside temperature like Run Mode. It also displays a set point and resume time. The Left and Right compass keys will cycle between regions in order: set point, month, day, year, hour minute. The Up and Down compass keys will adjust the current region.

Softkeys 1-3 do the same as above.

Softkey 4 will toggle the current thermostat back to Run Mode.



6.Using Lighting



Pressing Talk/Select when the icon bar is over Lighting will open the Unity Lighting menu. From this menu, the user may control any RF Lighting units connected to the Unity system. Also from this menu, Lighting Scenes may be created and executed.

The Lighting zones screen displays a list of all RF Lighting units and collections in the system. The Up and Down compass keys are used to navigate the list. The Left and Right compass keys will switch between the Zones and Scenes tabs at the top of the list.

Softkey 1 and 2 are used to adjust the highlighted zone's light level Down and Up respectively.

Softkey 3 is used to toggle the highlighted zone On and Off.

Softkey 4 is used to send the highlighted zone to a 100% value.



Lighting Scenes



The Lighting Scenes screen displays a list of scenes recorded in the Unity system. A Lighting Scene is a simple way to group together RF Lighting commands so they may be performed with a single button press. Pressing Talk/Select on any one of the scenes will execute the Lighting commands associated with that scene.

Softkey 1 (Rename) will display a virtual keyboard allowing the user to rename the highlighted scene.

Softkey 2 (Delete) will remove the highlighted scene from the system.

Softkey 3 (Create) will start the process for creating a new Lighting Scene. For details on creating a new scene refer to the instructions below.

Softkey 4 (Edit) is very similar to create however instead of making a new scene, the scene modifications will just be applied to the currently highlighted scene.

Creating a Lighting Scene

After pressing softkey 3 (Create) a virtual keypad will be displayed. Use the compass keys to enter a name for the scene. Softkey 4 will accept the name and advance to the zone inclusion screen.

The next screen will show a list of Lighting Zones currently in the system. The Up and Down compass keys will navigate the zone list. Pressing Talk/Select over any one unit will toggle its inclusion in the scene. A check will appear in the box under 'Include' if the unit is to be included in the scene. The Left and Right compass keys will adjust the level of the highlighted unit for the scene. This will not affect the zones level in real time, it will only set the level to which the unit will ramp when the scene is triggered. Softkeys 3 and 4 will set the zone scene level to 0% and 100% respectively.

When the scene is configured properly, pressing softkey 1 (Save) will save the scene to the system. The new scene will now be displayed in the Lighting Scenes list.



7.Using Cameras

Pressing Talk/Select when the icon wheel is over Cameras will bring up the Unity Cameras screen. This screen contains live feeds of all cameras connected to the system (Note: The feeds are displayed one at a time).



The softkeys in the camera screen switch between the camera feeds. If the Unity system is attached to no more than 4 cameras, softkeys 1-4 will switch to each of these four cameras respectively. If the Unity system is attached to more than 4 cameras the keys will be mapped as follows:

Softkeys 1-3 are mapped to cameras 1-3 OR cameras 4-6.

Softkey 4 is mapped to 'More' (as shown above) which toggles the mapping of softkeys 1-3.

Camera sequencing:

Pressing either the right or the left compass key will begin sequencing through the available cameras.

The dwell between camera switching can be adjusted by pressing the up or down compass keys.

To stop sequencing, the left or right keys may be pressed again, or any camera key may be pressed to switch to that camera and end sequencing.



8.Using Messages

Pressing the Talk/Select button while the icon wheel is over Messages will open the Unity Messaging screen. This screen provides the ability to send messages to Unity Intercom units. To send a message, follow the procedure below.



The main Messaging screen will display any messages the current unit has in its mailbox (this unit currently has none). Softkey 2 will send a new message.



A list of all possible destinations will appear. The Up and Down compass keys can be used to navigate this list. The Talk/Select button will designate a destination for the message.



To record the message, press Talk/Select to start recording, begin speaking, and press Talk/Select a second time to stop recording. Pressing Talk/Select a third time will send the message.



Once the message has been sent, it will appear in the mailbox of all units that are part of the destination. Softkey 4 will play the message (also removing the NEW tag). Softkey 3 will delete the message. The small message indicator light on bottom right of the LCD Console will blink a pattern indicating the number of NEW messages in its mailbox.

9.Using Weather

Pressing Talk/Select while the icon wheel is over Weather will bring up the Unity Weather screen. This screen gives an overview of current weather conditions and forecasts.



The left pane shows the outside temperature, sky condition, daily low and high temperature, current wind speed and direction, chance of precipitation and daily sunrise and sunset times. The right pane gives an abbreviated five day forecast.

Softkey 3 can be used to switch between Fahrenheit and Celsius.

Softkey 4 can be used to set the location for which the weather will be reported. Refer to the instructions below for setting the location.



Pressing softkey 4 (Location) will bring up a virtual keyboard. The location may be entered at this keyboard in one of two ways.

Option 1 – by US zip code: Using the compass keys, enter the zip code for the desired region. If the region can be found, the region name will be displayed in the top right corner. If not, a notification will pop up stating so.

Option 2 – by region name: Using the compass keys, enter the name of the desired region in the virtual keypad. For example, the current region above would be found by typing 'beverly hills, ca' into the virtual keyboard. Character case does not matter when typing in region names. (Note: for users located in Canada, names are to be typed in as <city>, Canada. For instance, for weather in Toronto, type in 'toronto, canada'.)



VII. Network Sharing

The following section describes the steps necessary to share a folder on the local network so it may be cataloged by the Unity Player function. After following the procedure for the correct music server operating system (i.e. the operating system running on the computer containing the music to be shared), refer to Appendix A to perform a Unity Player Catalog action.

Supported Server Operating Systems:

- Windows
 - XP
 - Vista
 - 7
- Apple
 - OS X

A. Windows XP

Before any sharing can be done in Windows XP, the Network Setup Wizard must be run. Follow these steps to run the Network Setup Wizard.

1. Log in as a member of the Administrators group.
2. Click Start, and then click on Control Panel.
3. Click 'Network and Internet Connections'.
4. Click 'Network Setup Wizard'.
5. On the 'Welcome...' page, click Next.
6. On the 'Before you continue' page, click Next.
7. If the wizard detects disconnected hardware, make sure all cables are connected and press Next. If a wireless connection will be used, select the 'Ignore disconnected network hardware' and click Next.
8. Choose the internet connection method. If the computer connects direction to a modem, select the first option. If the computer connects to a router first, select the second option.
9. If the 'Select your internet connection' page appears, click Next.
10. Give the computer a description and name and click Next.
11. Give the workgroup a name. (recommended name: WORKGROUP)
12. Select 'Turn on file and printer sharing'.
13. On the 'Ready to apply...' page, click Next.
14. Select 'Just finish the wizard' and click Next.
15. On the 'Completing the Network Setup Wizard page', click Finish.
16. Click Yes to restart the machine.

There are slight variations in the procedure for sharing music with Unity depending on the edition of Windows XP (e.g. Home, Professional, Media Center, etc). The variations will be described below as options.

1. Open Windows Explorer and locate the folder containing the music to be shared with Unity. (Note: It is easiest to group all music files and folders to be shared under a single folder (e.g. 'Unity Music') and then perform all share operations on this single folder. For simplicity sake, it is assumed all music is grouped as such.)

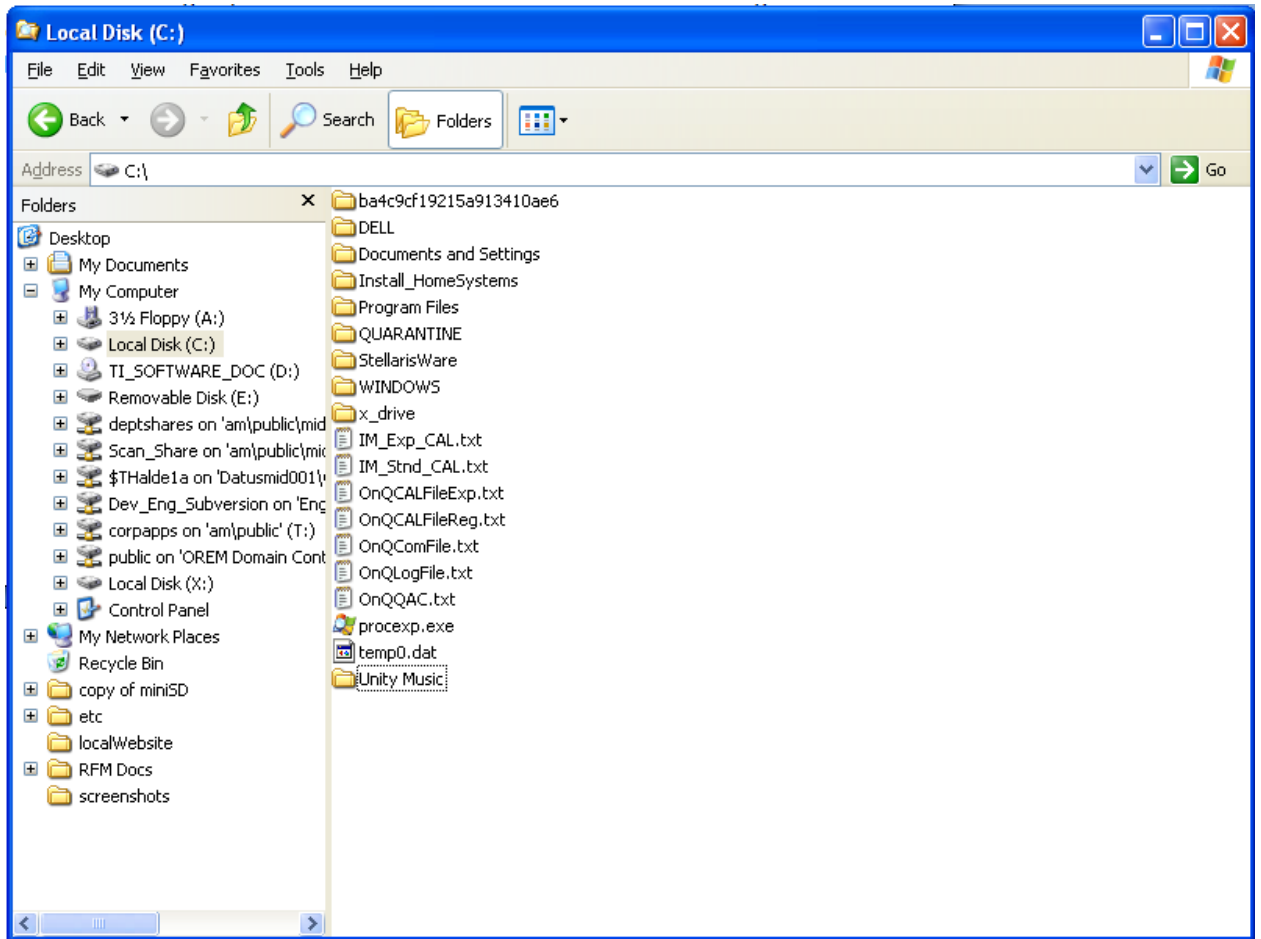

2. Right click the 'Unity Music' folder and click *Sharing and Security*. Click on the *Sharing* tab. Depending on the edition of Windows XP, there are two options:

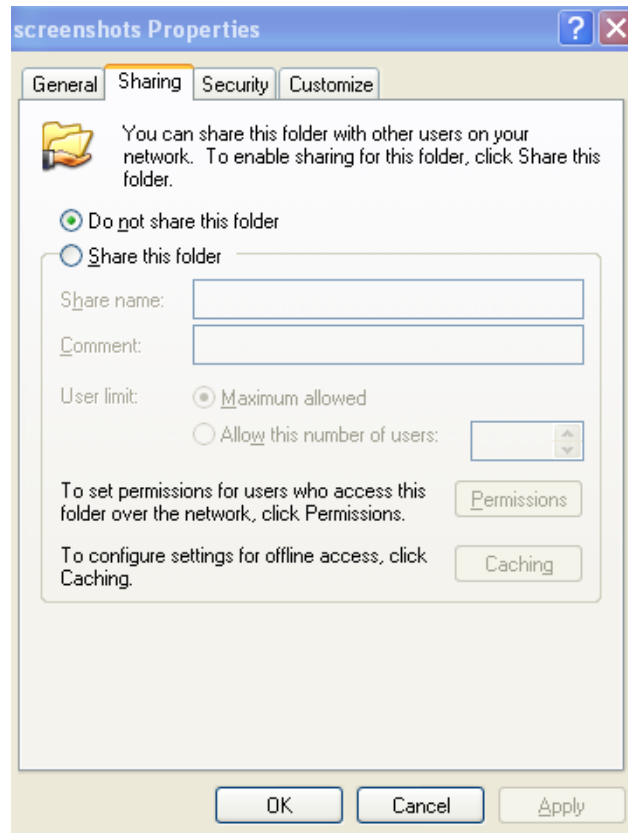

Option 1

Option 1: The tab will contain two radio buttons that read *Do not share this folder* and *Share this folder* respectively.

1. Click the radio button next to *Share this folder*.
2. (optional) Enter a *Share name*.
3. (optional) Set the *User limit*.
4. Click *Permissions*.
5. Make sure 'Everyone' is listed in the *Group or User Name* list with a permission of 'Read'. If not, click *Add* and type 'Everyone' into the textbox, then click *Check Names*. Once 'Everyone' is selected, click *OK*.
6. Click *OK* to exit the *Add* screen.
7. Click *Apply*, and then *OK* to exit the *Sharing and Security* window.

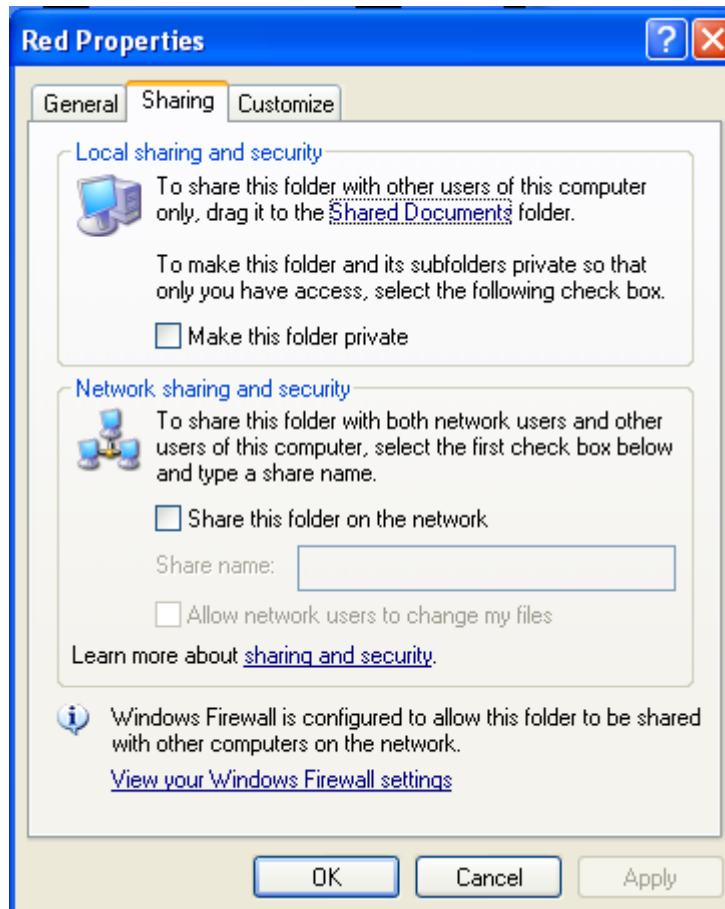

Option 2

Option 2: The tab will contain two sections labeled *Local Sharing and Security* and *Network Sharing and Security* respectively.

1. In the *Network Sharing and Security* section, click *Share this folder on the network*.
2. Enter a *Share Name* in the text field.
3. Leave the check box next to *Allow network users to change my files* blank.
4. Click *Apply*, and then *OK* to exit the *Sharing and Security* window.

If neither of the options above appears, or for any reason Music Sharing is still not functional, follow the troubleshooting steps outlined in Section V. Technical Troubleshooting – sub-section A.

B. Windows Vista

There are two methods for sharing music using the Windows Vista operating system. The first method (recommended) involves copying music to the 'Public Share' folder. The second method involves sharing the music from elsewhere without copying it to 'Public Shares'. Both methods are described in detail below:

Note - Both methods of sharing apply to the following editions of Windows Vista: Home Basic, Home Premium, Business, Ultimate, and Enterprise.

METHOD 1 – Copy to Public Shares:

Music Share Location:

1. Left Click Windows Start Menu button in lower left corner.
2. Select *Documents*.



3. Select *Public* from the left side menu under 'Favorite Links'.
4. Copy /Save music files into 'Public Music' folder.



Turning on Music Sharing

1. Left Click Windows Start Menu button in lower left corner.
2. Select *Control Panel*.



3. Double Click on *Network and Sharing Center*.



4. Turn ON *Network Discovery*.
5. Turn ON *File Sharing*.
6. Turn ON *Media Sharing*.
7. Turn OFF *Public Folder Sharing*.
8. Turn OFF *Password Protected Sharing*.



METHOD 2 – Share from anywhere:

1. Locate the files to be shared. (Note: It is easiest to group all music files and folders to be shared under a single folder (e.g. 'Unity Music') and then perform all share operations on this single folder. For simplicity sake, it is assumed all music is grouped as such.)
2. Right click the 'Unity Music' folder, and then in the context menu, click *Share*.
3. In the *File Sharing* dialog box: Click the arrow next to the text box, select *Everyone*, and click *Add*.

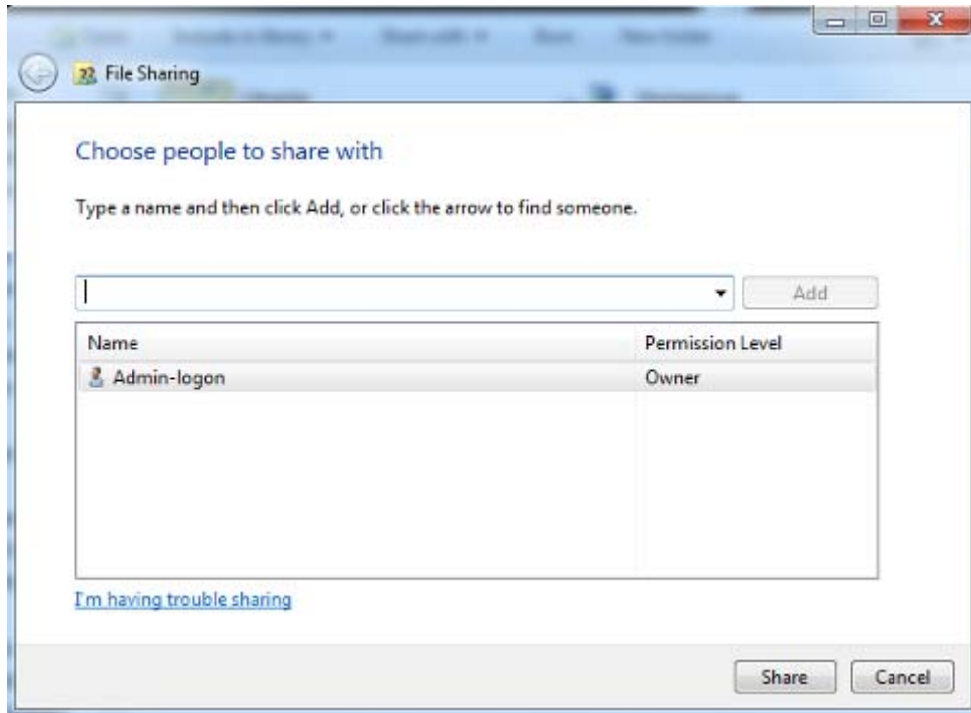

4. Under *Permission Level*, click the arrow next to *Everyone* and set them as a *Reader*.

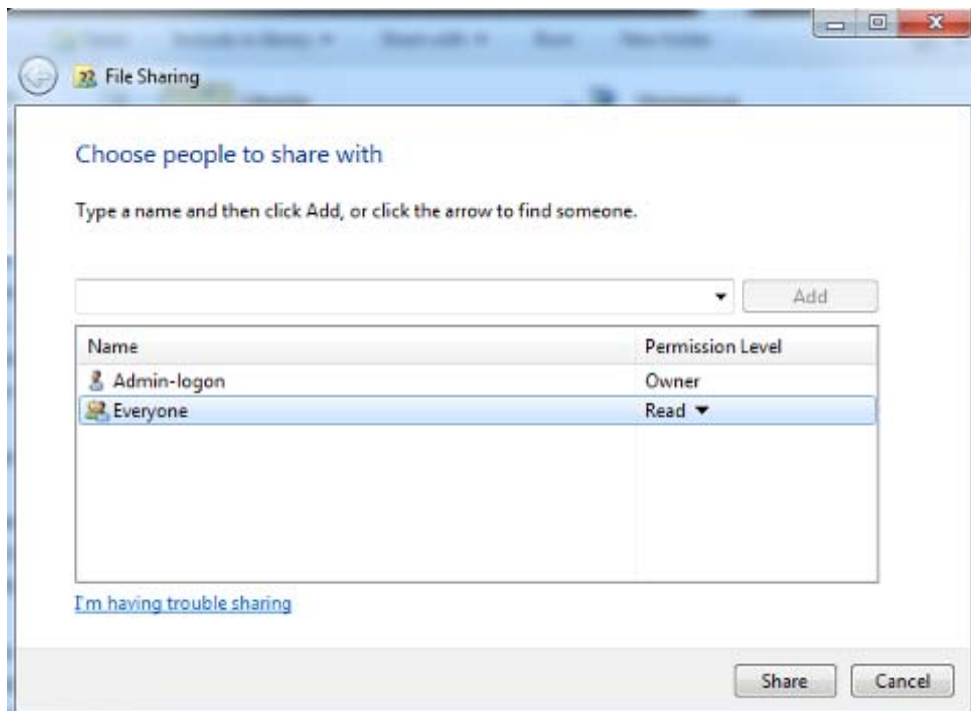

5. Click *Share*. If prompted, enter the administrator password or provide necessary confirmation.
6. Click *Done*.

Note: If the computer is in a workgroup, there is an option to enable or disable password protection. With password protection OFF, Unity will be able to discover the Music with only a Catalog action. With password protection ON, a computer name, share name, username, and password must be provided under Unity Player Setup. To enable/disable password protection open the *Network and Sharing Center* by following steps 1-3 from Method 1. Once there, turn OFF *Password Protected Sharing*.

If one or both of the previous methods have failed, and Music Sharing is still not functional, follow the troubleshooting steps outlined in Section V. Technical Troubleshooting – sub-section A.

C. Windows 7

There are two methods for sharing music for Unity using the Windows 7 operating system. The first method (recommended) involves copying music to the 'Public Share' folder. The second method involves sharing the Music from elsewhere without copying it to 'Public Shares'. Both methods involve a similar procedure, described below:

Note - Both methods of Sharing apply to all editions of Windows 7.

Music Share Location:

1. Click the Start Button in the lower left corner.
2. Click the appropriate user account name at the top of the right hand side of the menu.
3. Click the arrow beside *Libraries* to expand the folders.
4. Select the *Music* Item under libraries.

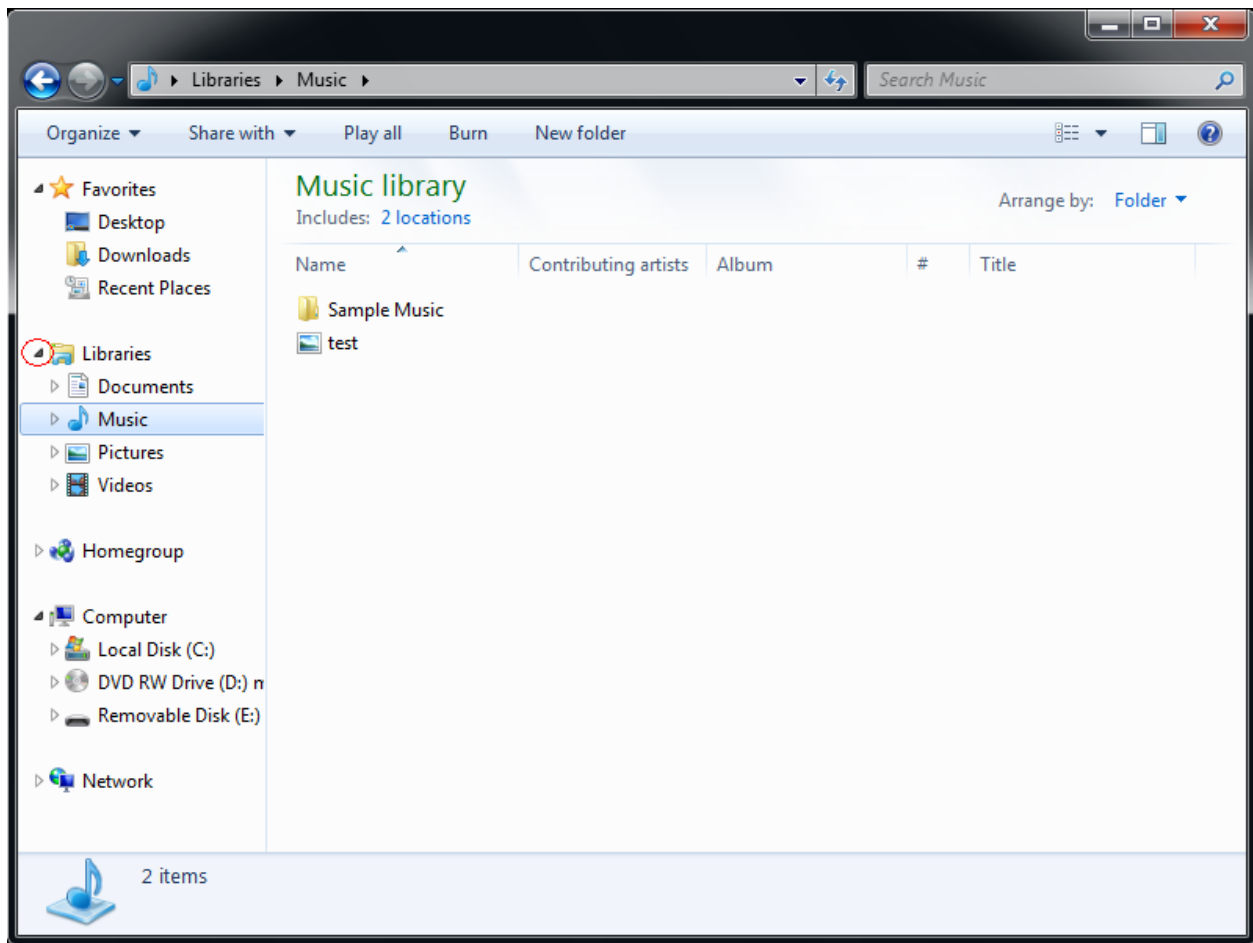

5. Copy/Move all music to be shared with Unity into this location. It is easiest to create a new folder named 'Unity Music' for example, and copy all music to this folder. This way all sharing can be done by performing actions on this single folder. (Note: at this point, if the music is to be copied somewhere else, as noted by the second option above, do so now, instead of copying to this location.)

Turn on Public Sharing

1. Click the Start button in the lower left corner.
2. Click on *Control Panel*.
3. Click *Network and Internet*.
4. Click *Network and Sharing Center*.
5. In the menu on the left, click *Change Advanced Sharing Settings*.

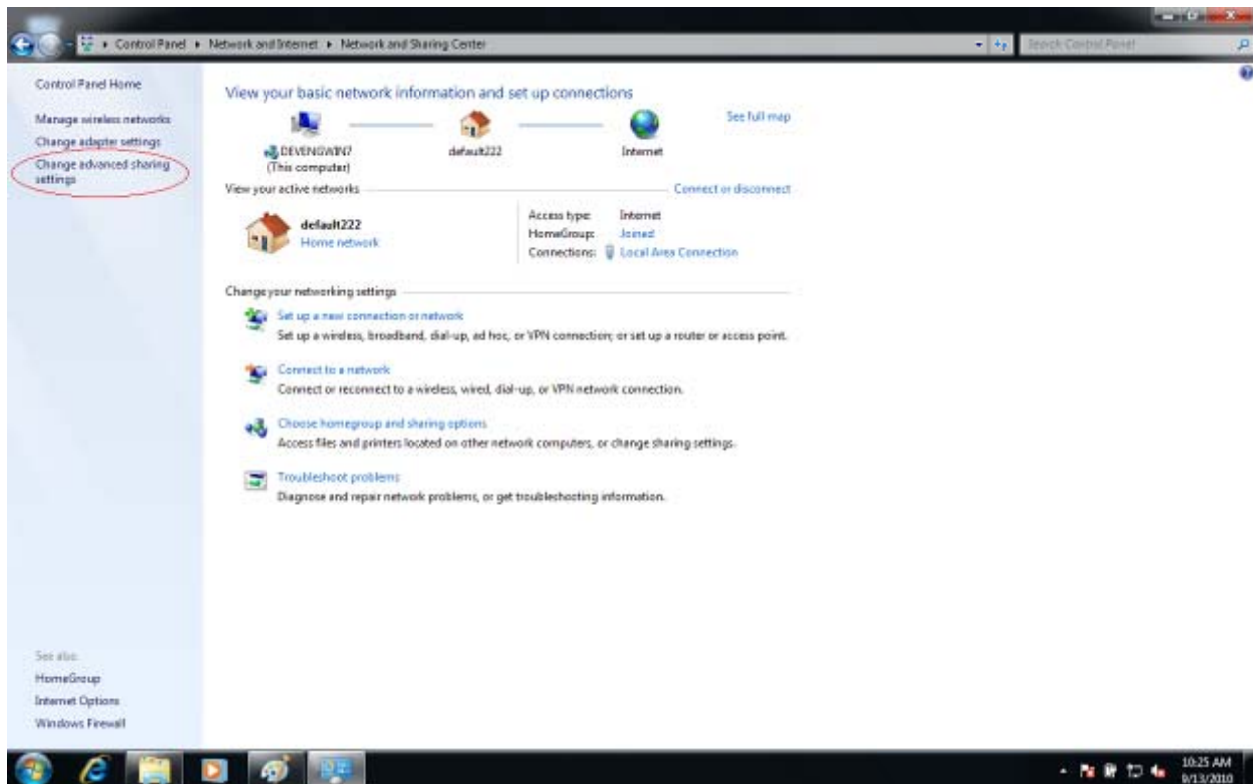

6. Click the down arrow to expand the current network profile.
7. Under *Public Folder Sharing*, turn ON sharing.
8. Under *Network Discovery*, turn ON discovery.
9. Under *File and Printer Sharing*, turn ON sharing
10. Click *Save Changes*. If prompted, provide administrator password or confirmation as needed.

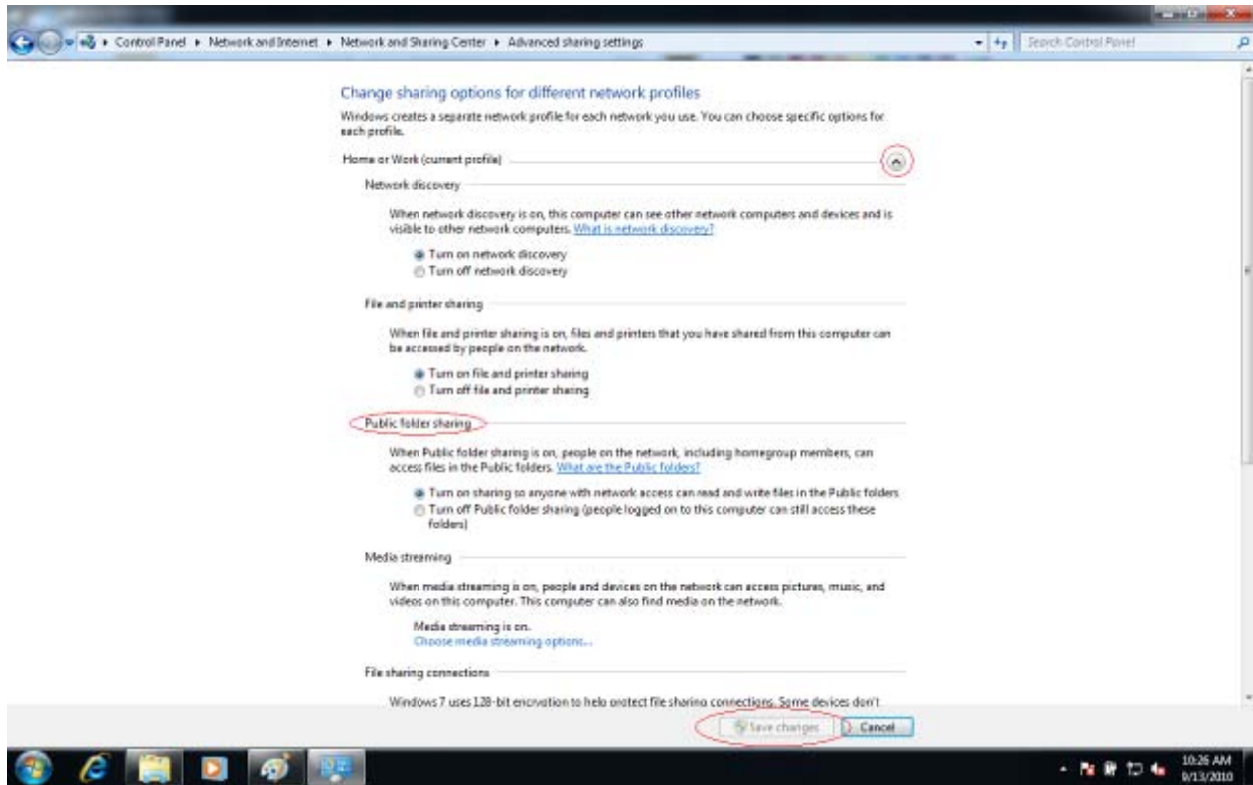

Turn ON Sharing

1. Locate the files to be shared. (Note: This is the folder the music was just copied in to. In this example, it will be referred to as 'Unity Music'.)
2. Right click the 'Unity Music' folder and click *Share With*, then select 'Specific People'.

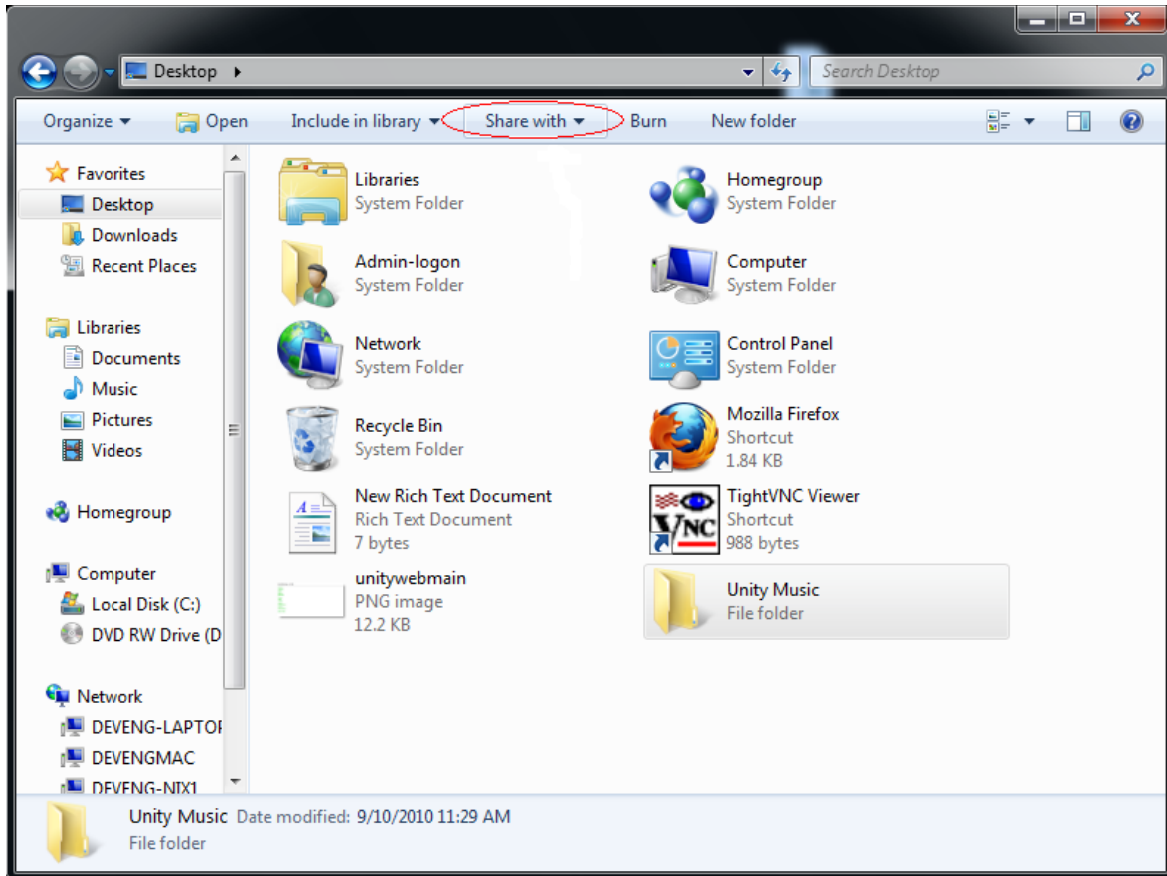

3. In the *File Sharing Wizard*, select the dropdown arrow next to the textbox, choose 'Everyone' from the list, and click *Add*.

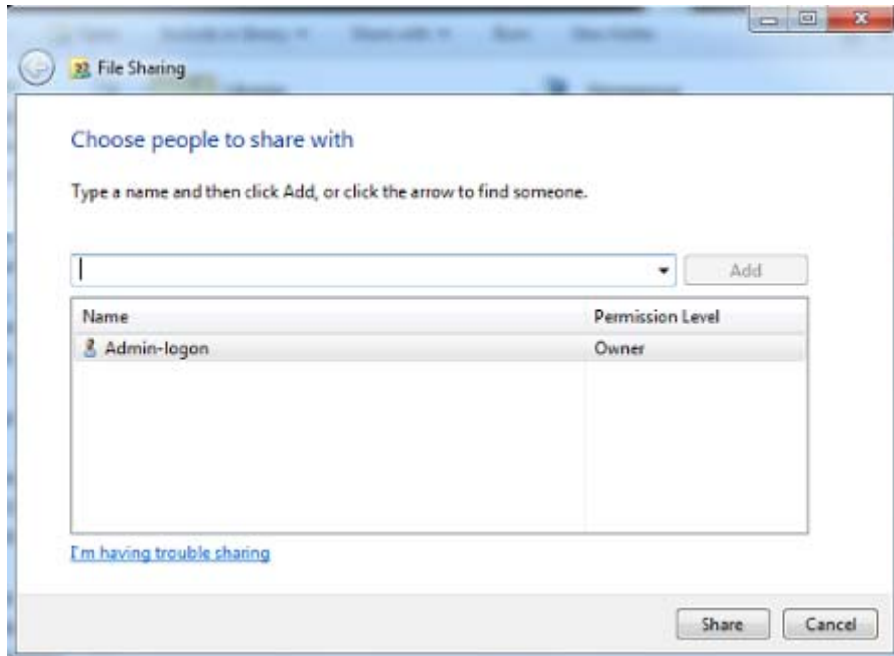

4. Under the *Permission Level* column, select *Read*.

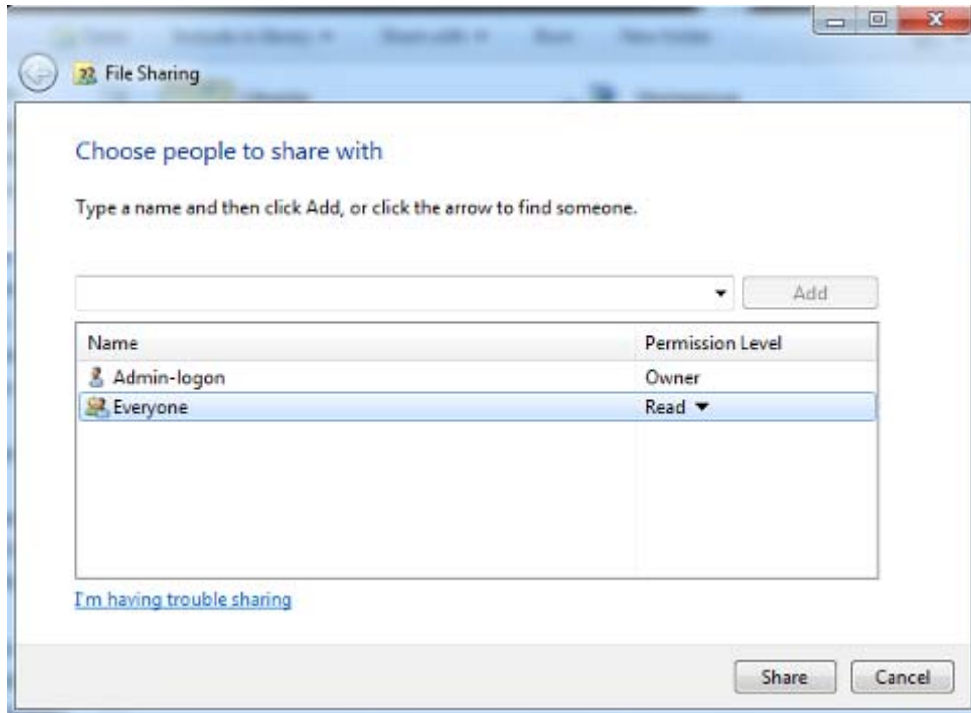

5. Click *Share*. If prompted, provide administrator password or confirmation as needed.

Note: With password protected sharing turned OFF, Unity will be able to discover the music with only a Catalog action. With password protected sharing turned ON, a computer name, share name, username, and password must be provided under Unity Player Setup. To enable/disable password protected sharing, open the *Advanced Sharing Settings* by following steps 1-6 from Method 1. Once there, turn OFF *Password Protected Sharing*.

D. Mac OS X Leopard/Snow Leopard (10.5.x & 10.6.x) Network Sharing

Apple has provided the means for their OS X operating system to share files via the SMB protocol (Windows File Sharing). This is the same file sharing mechanism that the Unity Integration Module uses to find shared music on the home network. Apple allows for two methods of sharing files. The first method is via public access viewable by anyone via the users Public folder and the enabling of Windows File Sharing. It is also possible to share a users folder (such as an iTunes library) using user level shares. Based on Apple's implementation this section is divided up into two methods, public level file sharing and User level file sharing.

Public Level File Sharing – This level of sharing enables any music in the Public Folders of each user of the computer to be seen by the Unity Integration module.

Go to → **System Preferences** → **Sharing**

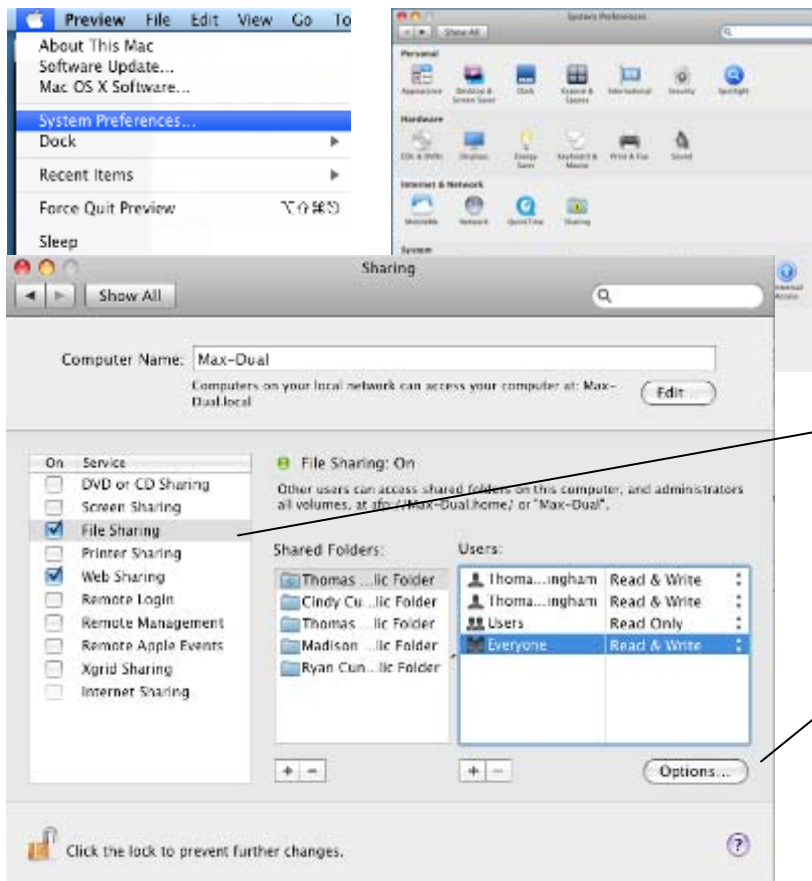

Select File Sharing, then the folder to share. Make certain that Windows File Sharing is enabled under Options

Folder Level Sharing (user level shares)

In order to share user folders you must enable file sharing, denote what folder(s) to share, and who has access to them. An account with administrative privileges will be necessary for this step. (this is the default account type)

While it is possible to share your own folders and use one of the administrative accounts, for security it is recommended to create a new user account that does not have administrative privileges. The following example will show the sharing of the user Thomas P Cunningham's iTunes music folder. A secondary account called Unity will be setup to have access to the folder. (This folder only)

Go to → System Preferences → Accounts



Then select the + sign to create a new account

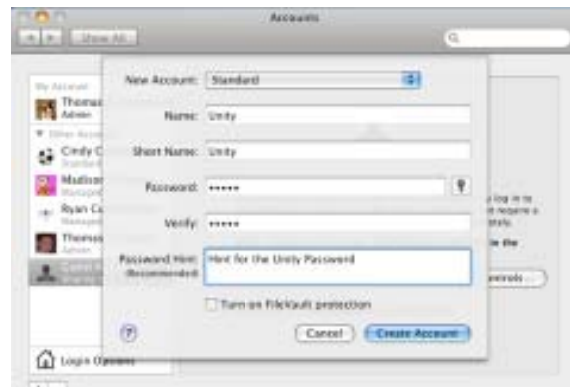

For this example we created a standard user account with the username of *unity* and any simple password you desire

Once satisfied with the settings press Create Account

The screen should now look similar to this (the graphic icon can be anything you select)



Press the back arrow at the top left to get to the main level of the System Preferences.

Select Sharing and then Select the + under Shared Folders to select the folder you would like to share. (In this exercise we are going to share the user tcunningham's Music Folder)



Select the Music Folder

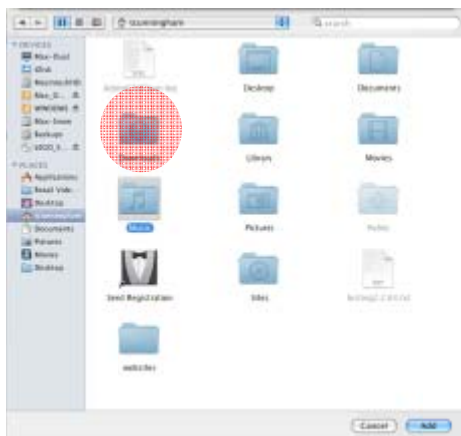

Highlight the folder you just shared (Music in this case) AND press the plus under Users. Add the unity account as one of the accts to see the share. NEXT press the Options button

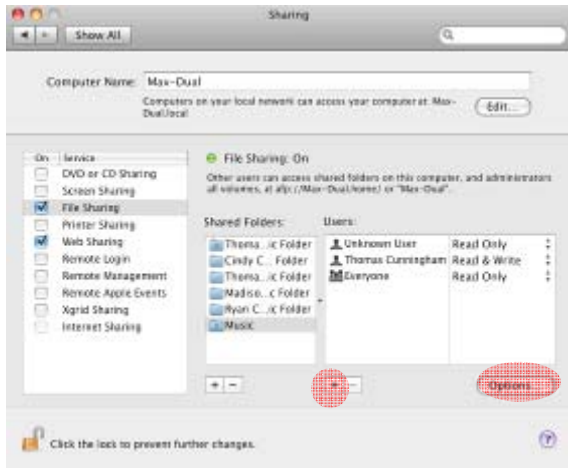

Select the check box Share files and folders using SMB AND select the Unity user account and select Done.

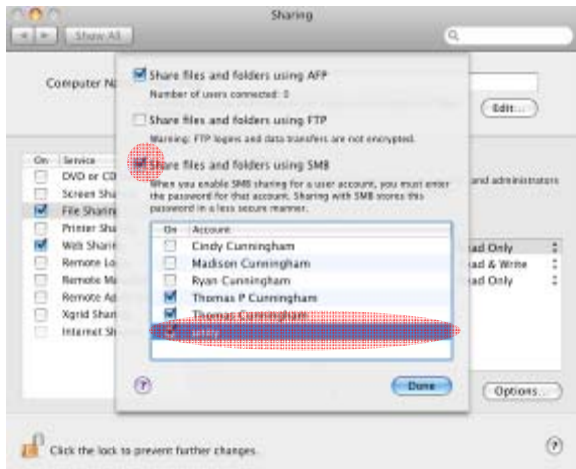

At this point you will have not shared the user tcunningham's iTunes Music folder to the unity user account. This information can now be entered into the Integration Modules Add a Share information so that Unity can see this iTunes library.

This can be done one of two ways...
 In web setup you will enter in the Computer Name of Max-Dual
 The music share of Music
 The Username of unity
 Lastly the password used to create the unity account.



The same could be entered by the Unity GUI.



E. Performing a Unity Catalog action

This section describes, in short, how to perform a Unity Catalog action. For full details on all Unity Player functions, see the Unity Player Documentation.

1. Power on a Unity LCD Console or Unity TVDI and navigate to the home screen.
2. Use the cursor keys to move the icon wheel and press Talk/Select to choose the Setup icon.
3. Use the cursor keys to scroll down, highlight and select the Player sub menu.
4. Press hotkey 2 (the green button on a Unity remote) to initiate a Player Catalog action.

VIII. Web Control

This section describes the Unity control that is available through the internet. The system allows for two types of interfaces:

- x.x.x.x/control – best used from a pc or tablet. The interface is optimized for a larger screen.
- x.x.x.x/mobile – best used from a mobile device (smart phone or iTouch). The interface is optimized for the smaller screen.

A. CONTROL

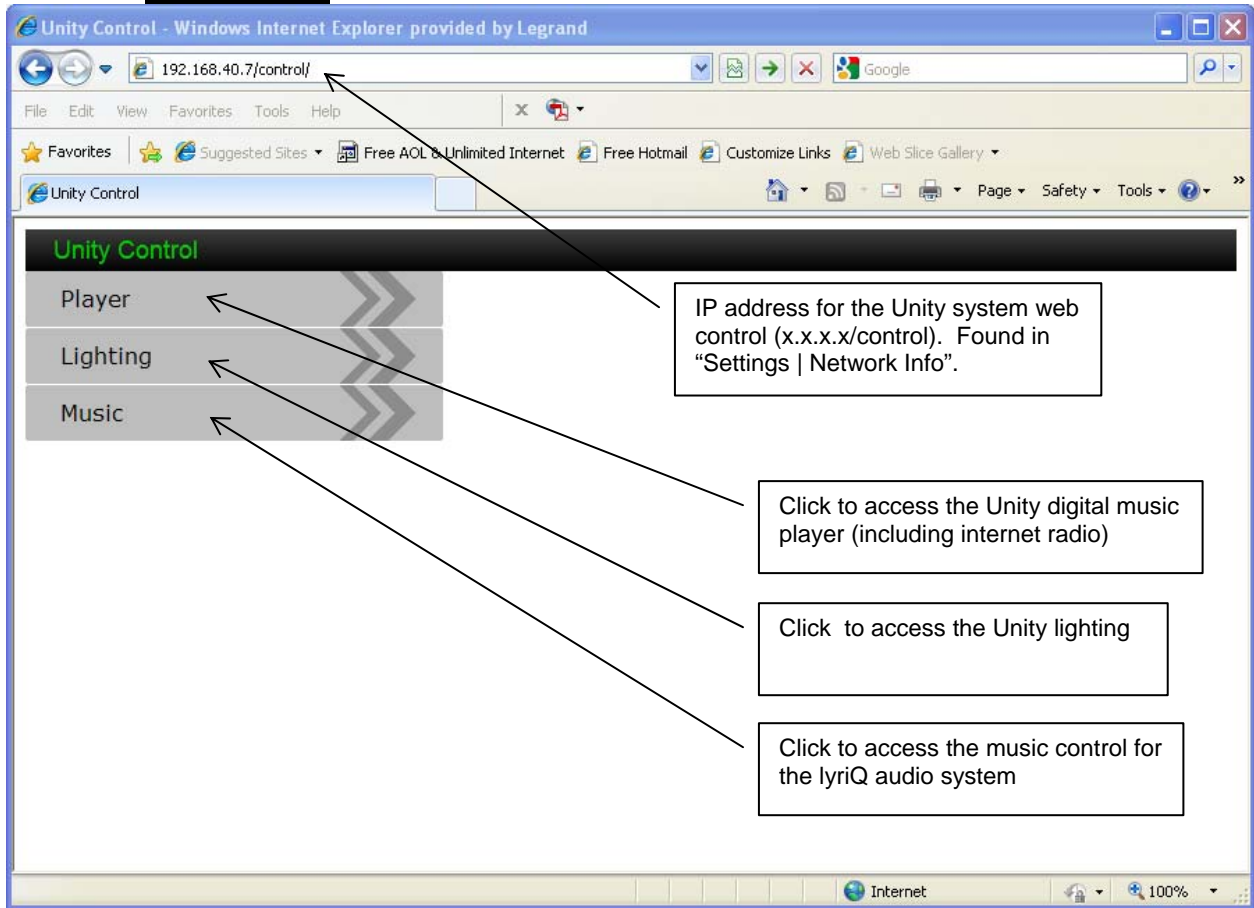

1. Unity Web Control - Player

The screenshot shows a web browser window titled "Player Control - Windows Internet Explorer provided by Legrand". The address bar shows the URL "192.168.40.7/control/player_ctrl.html". The browser's menu bar includes "File", "Edit", "View", "Favorites", "Tools", and "Help". The "Player Control" page has a dark header with the title "Player Control" in green. On the left is a vertical sidebar with menu items: "Playlists", "Songs", "Artists", "Albums", "Genres", and "Internet Radio", each with a right-pointing arrow icon. The main content area is titled "Now Playing" and features four playback control icons (previous, play/pause, repeat, next) at the top. Below these is a square album art image for "RUSH" showing a band in a grand hall. Underneath the image, the text reads: "Song: The Camera Eye", "Artist: Rush", and "Album: Moving Pictures". At the bottom of the page is a "Back To Main" link in green. A status bar at the very bottom shows "Done" on the left and "Internet" and "100%" on the right. Several callout boxes with arrows point to specific elements: one points to the "Player Control" header, another to the playback icons, a third to the "Internet Radio" menu item, a fourth to the album art and song information, and a fifth to the "Now Playing" section header.

Heading shows the submenu

Click for the type of music list

Player icons allow the user to select previous-song, pause/play, player-mode and next-song. The user can select between three player modes.

1. Normal – play continues until the end of the list.
2. Repeat – play continues until the end of the list, then repeats from the beginning of the list.
3. Shuffle – plays randomly through the list.

The now-playing pane shows what's currently selected.

Back To Main

If Playlists are selected, the user is presented a list of all playlist:

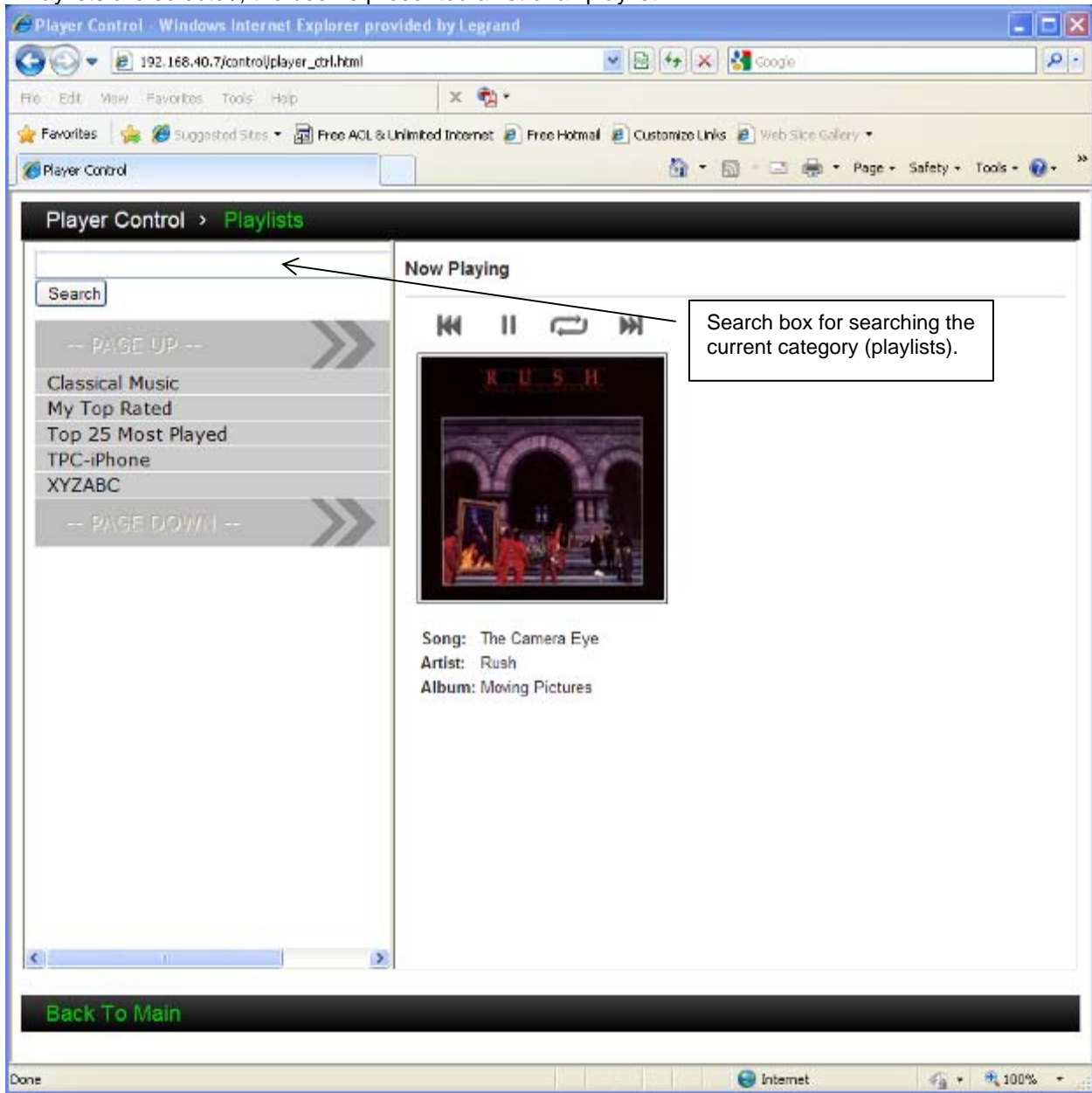

Choosing a playlist brings up a list of the songs in that playlist:

The screenshot shows a web browser window titled "Player Control - Windows Internet Explorer provided by Legrand". The address bar shows the URL "192.168.40.7/control/player_ctrl.html". The browser's menu bar includes "File", "Edit", "View", "Favorites", "Tools", and "Help". The Favorites bar contains "Player Control". The main content area has a breadcrumb trail: "Player Control > Playlists > Songs".

On the left side, there is a search box and a scrollable list of songs. The list includes titles such as "Concerto For Violin And Strings Op. 8", "Vom Himmel Hoch - F. Mendelssohn-f", "Ave Verum - W.a. Mozart / P.I. Tschai", "Der Messias/Messiah - G.F. Handel", "Tantum Ergo - F. Schubert", "Ave Maria - Ch. Gounod / J.S. Bach", "Laudate Pueri - F. Mendelssohn-Bartho", "Bringet Dem Herrn Ehre Seines Namer", "Laudate Dominum - W.a. Mozart", "Ave Maria - F. Schubert", "Virga Jesse - a. Bruckner", "Salve Regina - F. Schubert", "Wachet Auf Ruft Uns Die Stimme - J.S", "Largo - G.F. Handel", "Gloria - F. Mendelssohn-Bartholdy", "Symphone No. 94 In G Major 'Surpris", "Waltz No. 1", "Symphony No. 1 In D Major 'The Titar", "Brandenburg Concerto No. 4 In G Maj", and "With a Song in My Heart". Navigation buttons for "PAGE UP" and "PAGE DOWN" are visible.

On the right side, the "Now Playing" section features playback controls (stop, play/pause, repeat, next) and a thumbnail image of the album cover for "The Camera Eye" by Rush. Below the image, the following information is displayed: "Song: The Camera Eye", "Artist: Rush", and "Album: Moving Pictures". An arrow points from a text box to the song list, indicating that users can select a song to start playing the list.

At the bottom of the page, there is a "Back To Main" link. The browser's status bar shows "Done" and "Internet" with a 100% zoom level.

If Songs are selected, the user is presented a list of all songs:

The screenshot shows a Windows Internet Explorer browser window titled "Player Control - Windows Internet Explorer provided by Legrand". The address bar shows the URL "192.168.40.7/control/player_ctrl.html". The browser's menu bar includes "File", "Edit", "View", "Favorites", "Tools", and "Help". The Favorites bar contains "Player Control". The main content area is titled "Player Control > Songs". On the left, there is a search box and a scrollable list of songs. The list includes tracks like "(Do The) Instant Mash", "(Don't Go Back To) Rockville", and "The Camera Eye". On the right, the "Now Playing" section features playback controls (back, play/pause, repeat, forward) and an album cover for Rush's "Moving Pictures". Below the cover, the text reads: "Song: The Camera Eye", "Artist: Rush", and "Album: Moving Pictures". A callout box with an arrow points to the song list, containing the text: "From here, the user can select a song to start playing the list." At the bottom of the page, there is a "Back To Main" link. The browser's status bar at the bottom shows "Done", "Internet", and "100%".

If Artists are selected, the user is presented a list of all artists:

The screenshot shows a Windows Internet Explorer browser window titled "Player Control - Windows Internet Explorer provided by Legrand". The address bar shows the URL "192.168.40.7/control/player_ctrl.html". The browser's menu bar includes "File", "Edit", "View", "Favorites", "Tools", and "Help". The Favorites bar contains "Player Control" and several other links. The main content area is titled "Player Control > Artists" and features a search box, a list of artists, and a "Now Playing" section. The artist list includes names like "A Flock Of Seagulls", "a-Ha", "Aaliyah", "AC/DC", "Ace Of Base", "Aerosmith", "Amy Grant", "Angela Lansbury", "Anita Baker", "Antonio Vivaldi", "Aretha Franklin", "Avril Lavigne", "B.B. King", "B.B. King & Eric Clapton", "Baby Bash Feat. T-Pain", "Babyface And Tamia With Portrait And", "Bad Company", "Band Of The Grenadier Guards", "Barenaked Ladies", and "Barry Manilow". The "Now Playing" section displays album art for "Crash" by the Dave Matthews Band, with the song title "#41" and the artist name "Dave Matthews Band". The browser's status bar at the bottom shows "Done", "Internet", and "100%".

Choosing an artist brings up a list of all albums from that artist:

Player Control > Artists > Albums

Search

-- PAGE UP --

Get All Songs By This Artist

Big Ones

-- PAGE DOWN --

Now Playing

⏮ ⏪ ⏩ ⏭



crash

Song: #41
Artist: Dave Matthews Band
Album: Crash

From here, the user can select an album to get a song list from that album, or get a song list of all songs by this artist. The user can then select a song from that list to begin playing.

Back To Main

Done Internet 100%

If Albums are selected, the user is presented a list of all albums:

The screenshot shows a Windows Internet Explorer browser window titled "Player Control - Windows Internet Explorer provided by Legrand". The address bar shows the URL "http://192.168.40.7/control/player_ctrl.html". The browser's menu bar includes "File", "Edit", "View", "Favorites", "Tools", and "Help". The Favorites bar contains several links, including "Free AOL & Unlimited Internet", "Free Hotmail", "Customize Links", and "Web Slice Gallery".

The main content area is titled "Player Control > Albums". On the left side, there is a search box and a list of album titles. The list includes "10 from 6", "16 Most Requested Songs Of The 1942-24-03", "2000 Dec 13, Madison Square Garder", "20th Century Masters - The Millennium", "20th Century Masters - The Millennium", "20th Century Masters: The Millennium", "22 Preludes-Processionals-Recessiona", "80's Alive -Red-", "A Big Band Christmas Volume 3", "A Celtic Celebration", "A Charlie Brown Christmas (Remaster", "A Christmas To Remember", "A Time to Love", "A Touch Of David Foster", "AC/DC Live", "All or Nothing (Bonus Track Version)", and "All the Best". Navigation arrows for "PAGE UP" and "PAGE DOWN" are visible above and below the list.

On the right side, the "Now Playing" section features a music player interface with playback controls (back, play/pause, repeat, forward) and an album cover for "Crash" by the Dave Matthews Band. Below the cover, the following information is displayed: "Song: #41", "Artist: Dave Matthews Band", and "Album: Crash".

A callout box with an arrow pointing to the album name "Crash" contains the text: "From here, the user can select an album to get a song list from that album. The user can then select a song from that list to begin playing."

At the bottom of the main content area, there is a "Back To Main" link. The browser's status bar at the bottom shows "Done", "Internet", and "100%".

If Genres are selected, the user is presented a list of all genres:

The screenshot shows a Windows Internet Explorer browser window titled "Player Control - Windows Internet Explorer provided by Legrand". The address bar displays "http://192.168.40.7/control/player_ctrl.html". The browser's menu bar includes "File", "Edit", "View", "Favorites", "Tools", and "Help". The Favorites bar shows "Player Control" and several other links. The main content area is titled "Player Control > Genres" and features a search box, a "Search" button, and a scrollable list of genres. The "Now Playing" section displays a music player interface with playback controls and album art for the Dave Matthews Band. The status bar at the bottom shows "Done" and "Internet" with a 100% zoom level.

Player Control > Genres

Search

-- PAGE UP --

- 148
- A Cappella
- Acapella
- Adult Alternative Pop
- Adult Alternative Rock
- Adult Contemporary
- Alternative
- Alternative & Punk
- Audiobooks
- Bebob
- Big Band/Swing
- Blues
- Books & Spoken
- Children's Music
- Christmas
- Classic Pop Vocals
- Classic Rock
- Classic Soul/R&B
- Classical
- Comedy

-- PAGE DOWN --

Now Playing

DAVE MATTHEWS BAND
SEPTEMBER 11, 2000 - STAND UP FOR A BOLD BEHIND CONCEPT
MADISON SQUARE GARDEN - NEW YORK, NEW YORK

Song: (Anyone Seen The Bridge)
Artist: Dave Matthews Band
Album: 2000 Dec 13, Madison Square Garden [Disc 2]

Back To Main

Done Internet 100%

Choosing a genre brings up a list of all albums from that genre:

The screenshot shows a Windows Internet Explorer browser window titled "Player Control - Windows Internet Explorer provided by Legrand". The address bar shows the URL "http://192.168.40.7/control/player_ctrl.html". The browser's menu bar includes "File", "Edit", "View", "Favorites", "Tools", and "Help". The Favorites bar contains "Player Control" and several other links. The main content area is titled "Player Control > Genres > Albums". On the left, there is a search box and a list of albums under the heading "Get All Songs From This Genre". The list includes "2-24-03", "2000 Dec 13, Madison Square Garder", "Crash", "Live At Luther College [Disc 2]", "Live In Chicago - 12.19.98 [Disc 2]", "Remember Two Things", "The Central Park Concert [Disc 1]", "The Central Park Concert [Disc 2]", and "The Central Park Concert [Disc 3]". On the right, the "Now Playing" section displays the album cover for "R.E.M. eponymous" and the song "(Don't Go Back To) Rockville" by R.E.M. Below the album cover, the text reads "Song: (Don't Go Back To) Rockville", "Artist: R.E.M.", and "Album: Eponymous". A text box with an arrow pointing to the album list contains the following text: "From here, the user can select an album to get a song list from that album, or get a song list of all songs in this genre. The user can then select a song from that list to begin playing." At the bottom of the browser window, the status bar shows "Done" and "Internet" with a 100% zoom level.

If Internet Radio is selected, the user is presented a list on Internet Radio categories:

The screenshot shows a web browser window titled "Player Control - Windows Internet Explorer provided by Legrand". The address bar shows "http://192.168.40.7/control/player_ctrl.html". The browser's menu bar includes "File", "Edit", "View", "Favorites", "Tools", and "Help". The browser's toolbar includes "Favorites", "Suggested Sites", "Free AOL & Unlimited Internet", "Free Hotmail", "Customize Links", and "Web Site Gallery". The browser's status bar shows "Player Control".

The main content area is titled "Player Control > Internet Radio". It features a search bar with a "Search" button and a "Back" button. Below the search bar is a list of categories: "My Presets", "Local Radio", "Music", "Talk", "Sports", "By Location", "By Language", and "Podcasts".

The "Now Playing" section displays the SKY.fm logo, the song "A Thousand Miles (Original Album Version)" by "Summer Channel" from the album "Top Hits Music - S K Y . F M - who cares about the chart order, less rap & more hits!". Below the song information is the text "Powered by: radiotime".

The "Now Playing" section also includes playback controls: a play/pause button, a stop button, a rewind button, and a fast-forward button.

Annotations with arrows point to the search bar, the "Back" button, the "My Presets" category, the playback controls, and the "radiotime" logo.

The "Back To Main" button is located at the bottom of the interface.

The browser's status bar shows "Internet" and "100%".

The Search box may be used to search for an available internet radio station.

The player controls allow you to pause, rewind or fast-forward the internet radio station radio station. Fast forward cannot be used to travel forward in time.

The "My Presets" will only be available if the user has a radiotime account and has provided the account information to the Unity System through the Settings screen.

Choosing a category will expand that into further categories...

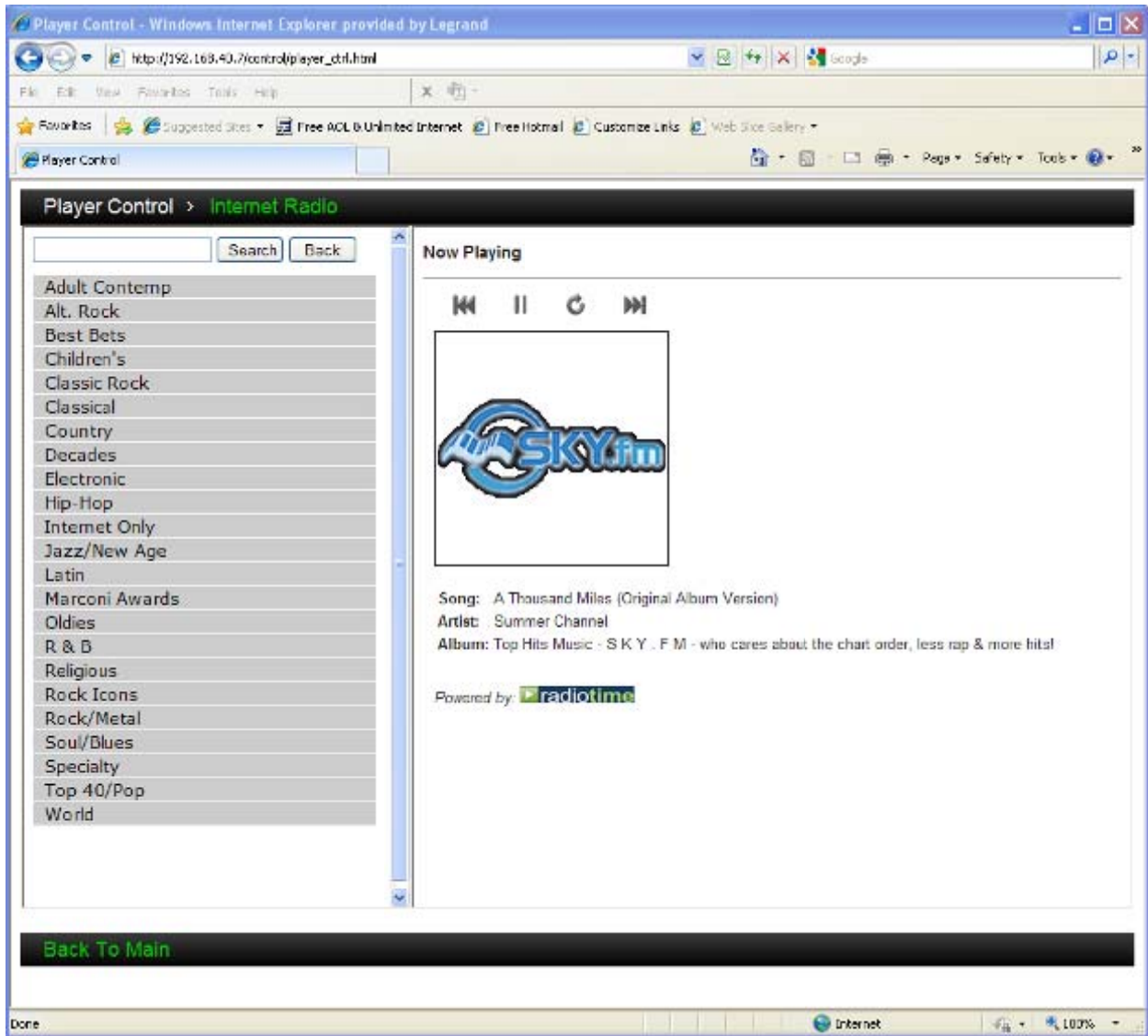

...until eventually resulting in a list of available stations to choose:

Player Control > Internet Radio

Search Back

Stations

- ABC Triple J (Sydney, Australia)
- XFM London (London, UK)
- GotRadio Mash-Ups
- Y-Rock (Philadelphia, PA)
- 181.FM 90's Alternative
- 181.FM The Buzz (Alt. Rock)
- SKY.fm Alternative Rock
- SKY.fm Indie Rock
- KROQ (Pasadena, CA)
- K-Rock (New York, NY)
- Live 105 (San Francisco, CA)
- East Village Radio
- Q101 (Chicago, IL)
- Radio 92.9 (Brookline, MA)
- the EDGE (Brampton, Canada)
- X-96 (Provo, UT)
- 98 ROCK (Baltimore, MD)
- WNRN (Charlottesville, VA)
- 1.FM - High Voltage
- Phantom 105.2 (Dublin, Ireland)
- 1.FM - Flashback Alternatives
- Rock Radio1 (UK)
- 95bFM (Auckland, New Zealand)

Now Playing

⏮ ⏪ ⏩ ⏭



Song: Welcome To The Black Parade [Edit]
Artist: My Chemical Romance
Album: Top Hits Music - S K Y . F M - who cares about the chart order, less rap & more hits!

Powered by: 

Choose a station to begin playing

Back To Main

2. Unity Web Control – Lighting

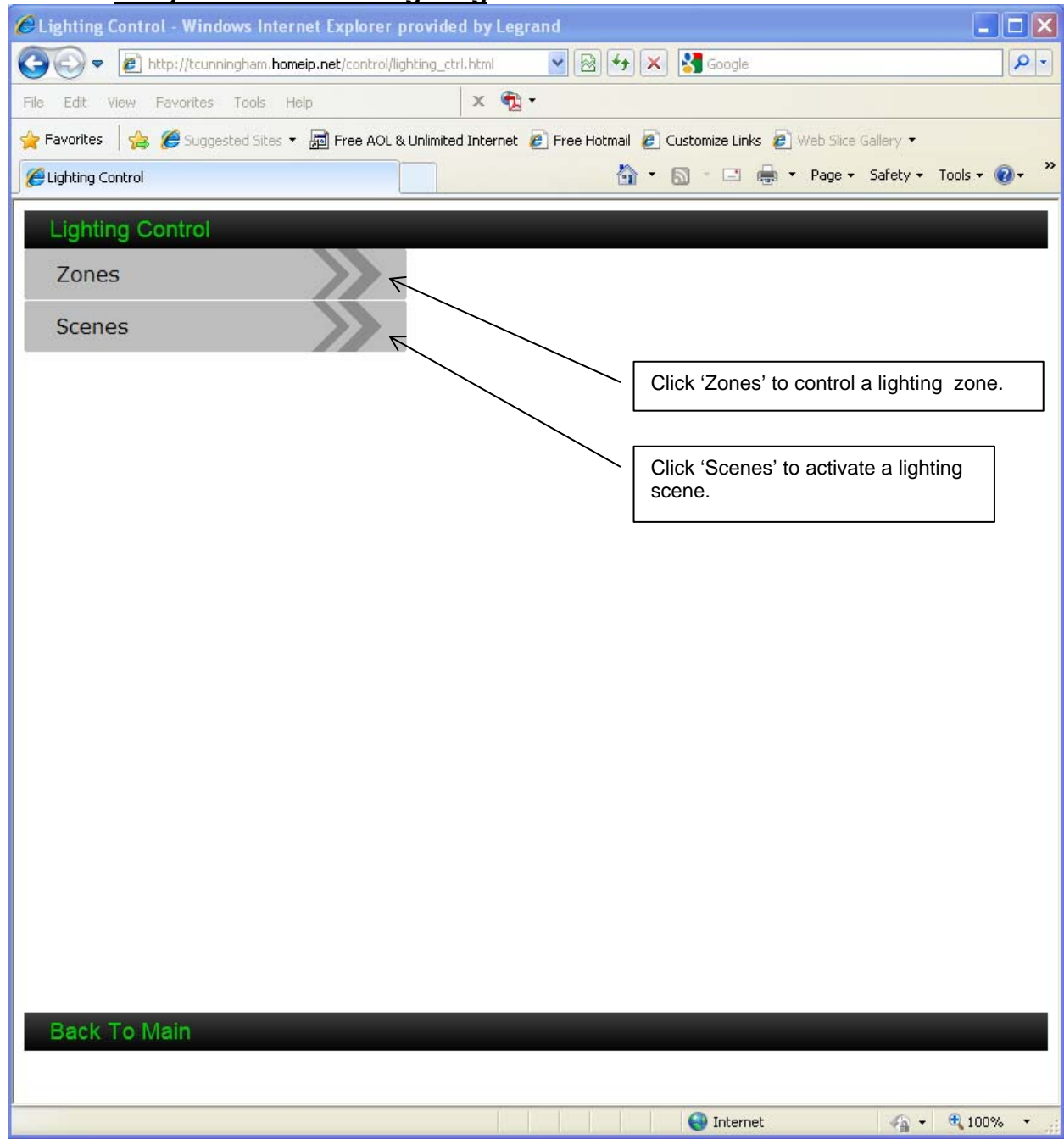

Unity Web Control – Lighting > Zones

Lighting Control > Zones

Choose a Zone

- ALL
- Kitchen
- Downstairs
- Entry Lights
- Upstairs Lights
- Front Porch
- Office Table Lamp
- Kitchen Table
- Entry Chandelier
- Bar Left
- Family Table Lamp
- Front Window
- 1864
- Office floor lamp
- 2056
- Side Door
- Back
- 2468
- Patio
- Family Lamp
- Garage
- Kitchen Ropes
- Garage Front
- Garage Door
- Dining Room

Back To Main

Click on ALL to control all zones simultaneously.

Click on a zone to access that zone's controls.

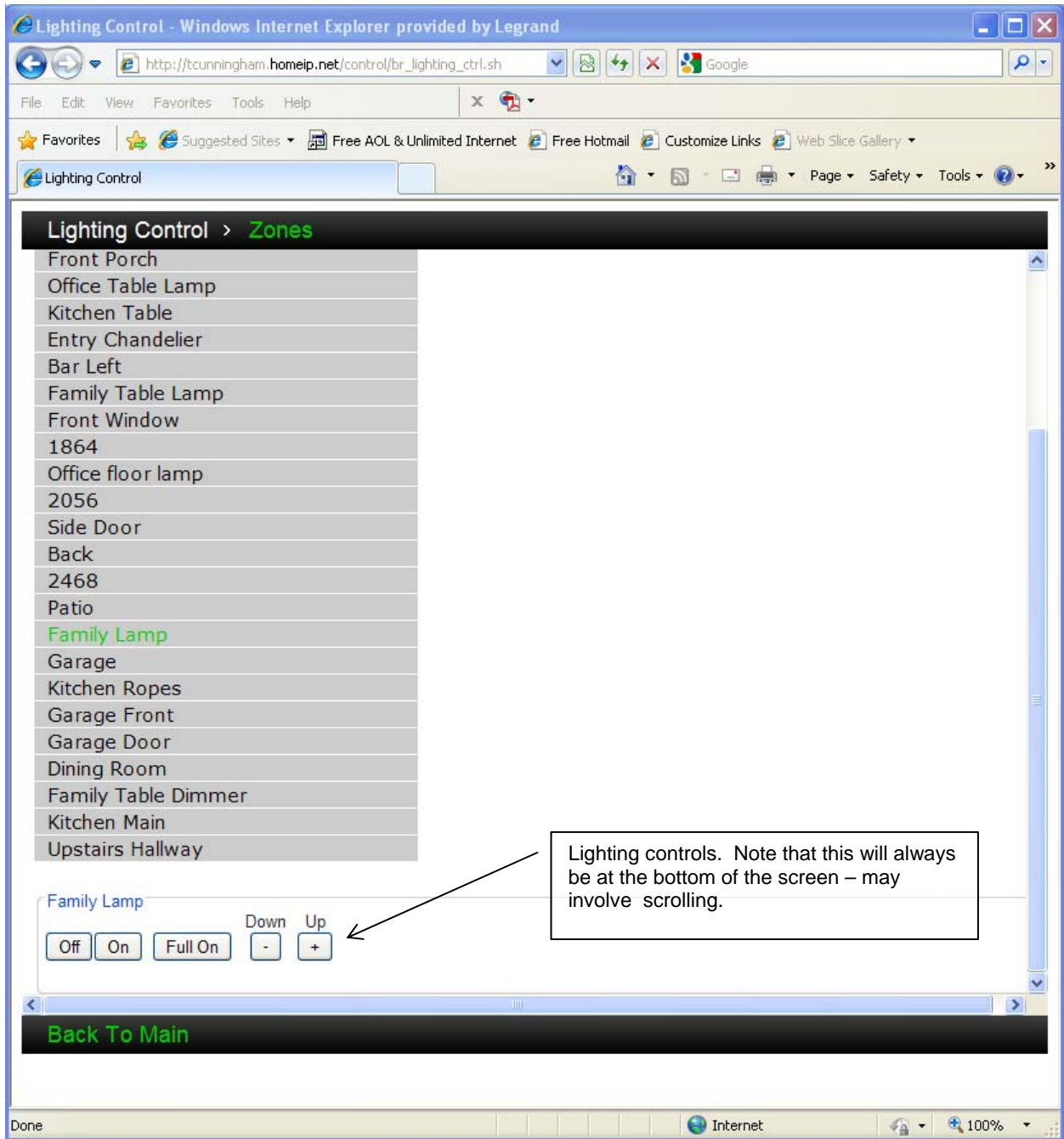

Unity Web Control – Lighting > Scenes

Lighting Control - Windows Internet Explorer provided by Legrand

http://tcunningham.homeip.net/control/sc_lighting_ctrl.sh

Lighting Control > Scenes

Choose a Scene to Execute

- All Lights On
- Daily Evening Work
- Daily Late Night
- Goodnight
- End of Night

Click on a scene to activate that scene.

Back To Main

Done Internet 100%

3. Unity Web Control – Music Control

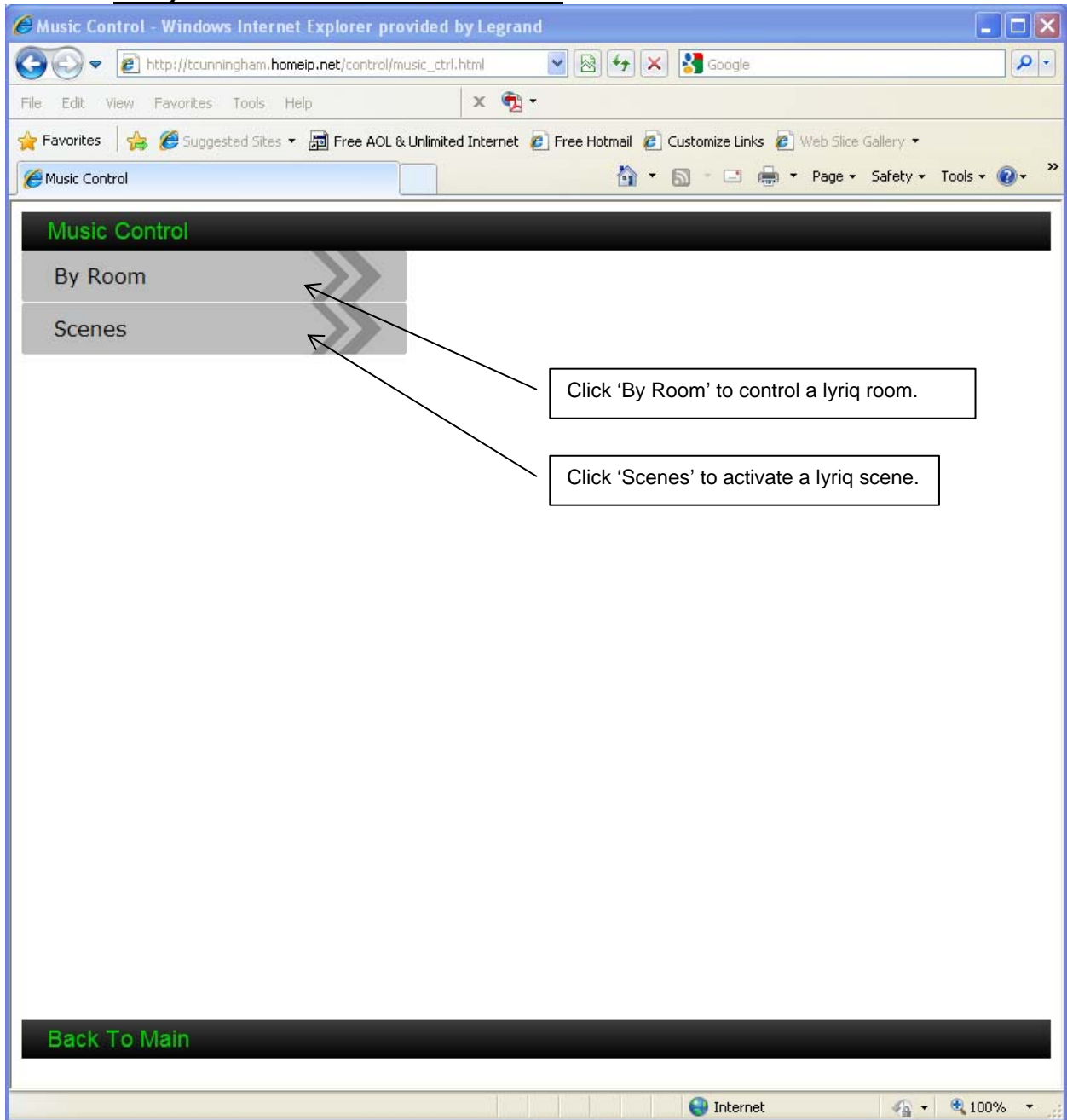

Unity Web Control – Music Control > By Room

Music Control > **By Room**

Choose a Room

- WHOLE HOUSE**
- Kitchen
- Master
- Play Room

Click on **WHOLE HOUSE** to control all rooms simultaneously.

Click on a room to access that room's controls.

[Back To Main](#)

Music Control - Windows Internet Explorer provided by Legrand

http://tcunningham.homeip.net/control/br_music_ctrl.sh

File Edit View Favorites Tools Help

Music Control

Music Control > **By Room**

Choose a Room

WHOLE HOUSE

- Kitchen**
- Master
- Play Room

Kitchen

on mute volume 00 source Sat Radio dnd

lyriq audio controls. Note that this will always be at the bottom of the screen – may involve scrolling.

[Back To Main](#)

Internet 100%

Unity Web Control – Music Control > Scenes

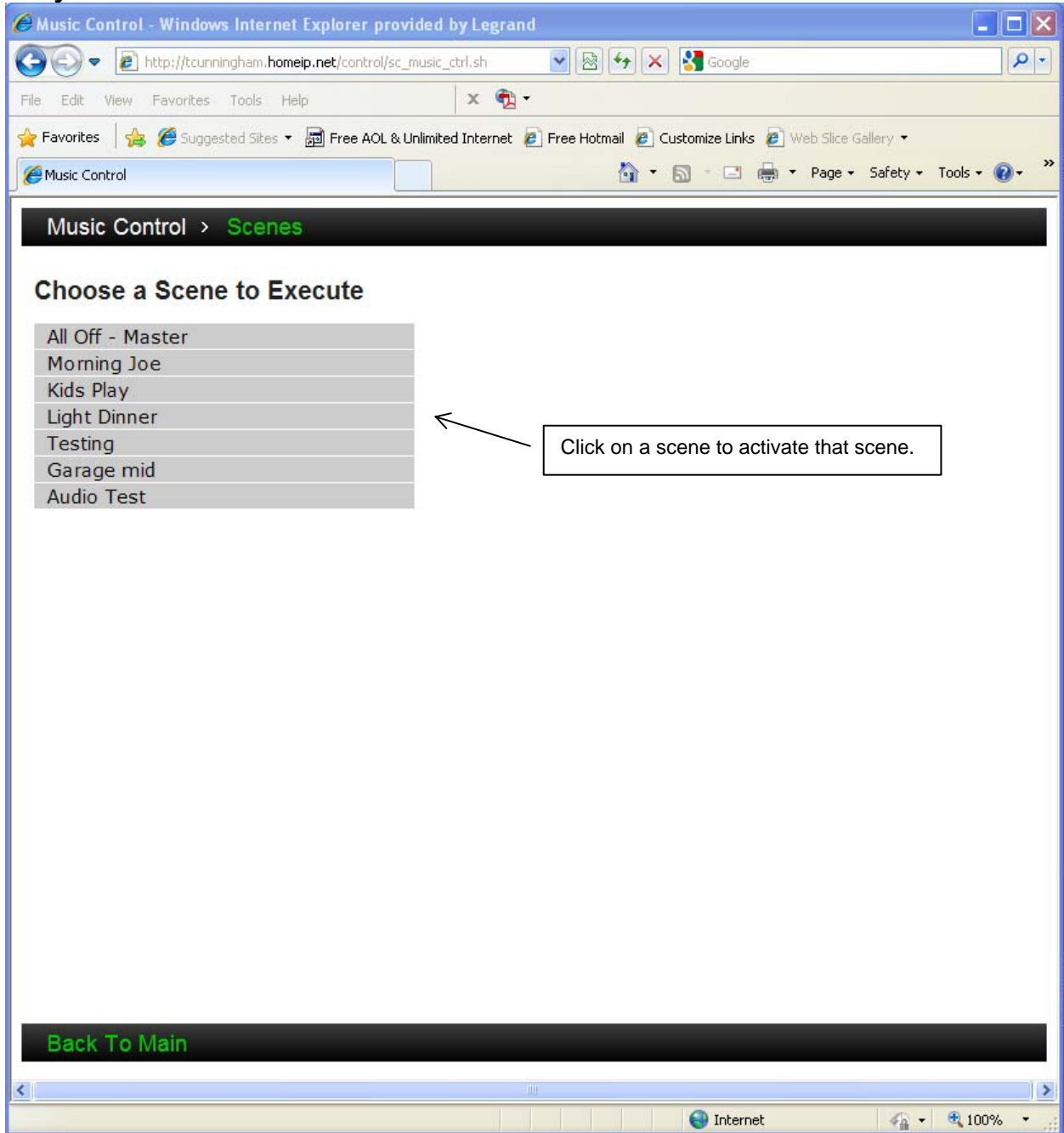

B. MOBILE

Designed to use mobile devices with webkit compatible browsers such as the iPhone, iPod Touch, iPad, Android, Blackberry Storm, WebOS, and other devices.



IP address for the Unity system web mobile (x.x.x.x/mobile). Found in "Settings | Network Info". Note that this is generally hidden, as shown in the following pictures.



Control selections.

1. Unity Web Mobile – Player



Returns to main menu.

Player selections. Refer to control description for functionality.

To conserve screen space, the "Now Playing" screen is now a separate window.

Unity Web Mobile – Player – Now Playing



Returns to Player main menu.

Now playing controls. Refer to control description for functionality.

Unity Web Mobile – Player – Songs



Song list. Choose a song to begin playing. Playlists, Artists, Albums and Genres work similarly. Refer to control description for functionality.

Unity Web Mobile – Player – Internet Radio



Internet Radio list. Choose an item to navigate the station list.



Internet Radio station list (from My Presets). Choose an item to begin playing that station.

2. Unity Web Mobile – Lighting



Lighting selections. Refer to control description for functionality.

Unity Web Mobile – Lighting – Zones



Lighting zones. Select a zone to bring up the control screen.

Unity Web Mobile – Lighting – Zones – Control



← Lighting zone control. Select a box to control the lighting zone.

Unity Web Mobile – Lighting – Scenes



Select to activate this Lighting Scene.

3. Unity Web Mobile – Music



Music selections. Refer to control description for functionality.

Unity Web Mobile – Music – By Room



lyriq audio zones. Select a zone to bring up the control screen.

Unity Web Mobile – Music – By Room - Control



← lyriq audio zone control. Select a checkbox to activate/deactivate Power and Mute. Select the down arrow to access menus for Volume and Input.

Unity Web Mobile – Music – By Room – Control – Volume



Scroll and select to set this zone's volume.

Unity Web Mobile – Music – By Room – Control – Input



Select this zone's source input.

Unity Web Mobile – Music – Scenes



Select to activate this Music Scene.

IX. Specifications

A. Absolute Maximum System Limitations:

1. System
 - a. 64 Total Devices.
 - i. Every element of the Unity system counts towards this limitation (Integration Module, Integration Expansion, LCD Module, Combo/Camera Module, LCD Console, TVDI, SCI Controller, Room Unit, Door Unit, Video Door Unit, Patio Unit, Studio Camera)
2. Intercom
 - a. 32 Studio Intercom Units
 - i. Every device that can act as a Unity Studio intercom station counts towards this limitation (LCD Console, Room Unit, Door Unit, Video Door Unit, Patio Unit)
 - ii. Each Intercom station can have a single video source associated with it.
 - a) When a video source is associated with an intercom station, it will be displayed as an inset window in the Intercom screen when this unit is highlighted.
 - iii. Each Intercom station can be associated with up to 4 lyriQ Audio Zones.
 - a) When an audio zone is associated with an intercom station, this audio zone will be muted during an intercom call involving this station.
 - b. 8 Groups
 - i. Each Group can contain any or all Intercom Units
 - c. 30 Door Chimes
 - i. 20 standard door chimes (pre-programmed by Legrand)
 - ii. 10 user generated door chimes
 - d. 4 Door Release outputs
 - i. Open collector outputs used to trigger a relay to activate the door strike
 - e. 4 Doorbell Alerts outputs
 - i. Open collector outputs used to trigger other systems that the doorbell was activated.
3. User Interfaces
 - a. 8 Distinct User Interfaces (LCD Console-HA5000-xx, HA5009-xx, or HA5010-xx or TVDI HA5201-xx)
 - i. With a fully expanded system (1 Integration Module: HA6001 and 3 Integration Expansion Modules: HA6101), the system can serve 8 independent and unique user interfaces.
 - a) Each user interface can be expanded to 8 duplicate TVDI's. Each TVDI on this expansion will show the same user interface.
 - b. User Interface Display Timeouts
 - i. LCD Console Power-Down Timeout selectable from 5 minutes to 1 hour.
 - ii. TVDI Screen Save Timeout selectable from 5 minutes to forever.
4. Video Inputs (Cameras: CM5002-xx and Video Door Units: IC5003-xx)
 - a. 6 Video Inputs
 - i. Requires LCD Module: CM1010 or Camera/Combo Module: CM1048.

- b. Video sequencing rate adjustable between 1 second and 30 seconds.
- 5. lyriQ (Audio Distribution)
 - a. 16 Distinct lyriQ Audio Stations
 - i. With a lyriQ Expander AU1023, we support 16 unique lyriQ zones.
 - a) Each zone can be expanded to 4 duplicate lyriQ zones through the cascading of a 1x4 module: AU7396. Each lyriQ zone on this expanded 1x4 module: AU7396 will receive the same source.
 - b) Note that for an expanded zone, only one of the keypads in this zone can be selected as master. This is the keypad that will respond with the status for this zone.
 - b. 5 Distributed Sources, 2 Local Sources per zone
 - i. Source 1-4 from 4x8 Module: AU1002
 - a) Analog sources received from 3rd party AV equipment
 - ii. Source i from Integration Module
 - a) Digital audio content from Music Shares or Internet Radio
 - iii. 2 Local Sources: AU5008-XX per Audio Zone
 - c. 8 Scenes
 - i. Each scene can contain any or all of the lyriQ zones
- 6. HVAC
 - a. 3 Thermostats
 - b. Thermostat Schedules
 - i. 7 days
 - ii. 4 periods/day
- 7. Lighting
 - a. 128 Zones of lighting
 - b. 10 collections
 - i. Each collection can contain up to xxx zones
 - c. 10 scenes
 - i. Each scene can contain up to xxx zones
- 8. Events
 - a. 20 Events
 - b. Each Event can contain up to 4 individual actions.
- 9. Messages
 - a. Up to 30 Messages, each up to 4 minutes in length
- 10. Player (Digital Audio Content Manager)
 - a. Maximum tested limits for cataloging:
 - i. 50,000 songs.
 - ii. 10,000 albums.
 - iii. 10,000 artists
 - iv. 1000 genres
 - v. 1000 playlist
 - b. 8 Network-Share Entries

B. Typical System Specifications

1. Single Unity Integration Module HA6001

- a. User Interfaces (LCD Console HA5000/HA5009/HA5010-xx & TVDI HA5201-xx)
 - i. Minimum: 0 interfaces
 - a) Although the Unity system will operate without any user interfaces, this configuration will result in all setup and control being performed via the web-setup and web-control.
 - ii. Maximum: 2 interfaces
 - a) A single Integration Module HA6001 can drive 2 separate user interfaces (LCD Consoles HA5000/HA5009/HA5010-xx and TVDI's HA5201-xx).
 - iii. TVDI Expanders HA5202 – Maximum: 2 Cascaded Expander Pairs for a total of 16 ports (4 + 4 & 4 + 4).
 - a) Using a TVDI expander HA5202, either (or both) of these user interfaces can be expanded to service 4 TVDI's HA5201-xx. A second TVDI Expander HA5202 can be cascaded to allow up to 8 TVDI's HA5201-xx. Note that each of the expanded TVDI's HA5201-xx will be presented the same user interface.
- b. Video Devices (Cameras CM5002-xx and Video Door Units IC5003-xx)
 - i. Minimum: 0
 - ii. Maximum: 4
 - iii. The Integration Module HA6001 specifies 2 ports for cameras CM5002-xx and 2 ports for Qlink Video (Video Doors IC5003-xx). However, any of these ports may be used for either device type.
 - a) NOTE: for an EXPANSION system using HA6101, only the Qlink Video ports are cascaded. The Camera ports must be cascaded through the use of LCD Module CM1010 or Combo/Camera Module CM1048.
- c. Intercom Devices (Room Units IC5000-xx, Door Units IC5002-xx, Patio Units IC5004-xx)
 - i. Minimum: 0
 - ii. Maximum: 12
 - iii. The Integration Module HA6001 specifies 8 ports for intercom connections. However, the Camera Ports and Qlink Video Ports may be used as additional intercom ports, if they are not needed for cameras CM5002-xx or video doors IC5003-xx. This provides the additional connection ports for a total of 12.
 - iv. 1 Door Release Output
 - v. 1 Doorbell Alert Output
- d. lyriQ Devices
 - i. Connection to lyriQ 1x4 Modules AU1014
 - a) Maximum: 4 lyriQ Zones
 - 1) Each lyriQ Zone connection can be expanded through the use of a 1x4 AU1014 to expand to 4 keypads in a single zone. Note that

- for this option, all keypads in the expanded zone will be set to the same source.
 - b) Maximum: 2 Distributed Sources
 - 1) Source 1 from 1x4 AU1014
 - 2) Source i from Integration Module HA6001
 - c) Maximum: 4 lyriQ Local Sources AU5008-xx
 - 1) Each zone can support up to 4 Local Source Inputs AU5008-xx
 - ii. Connection to lyriQ 4x8 Modules AU1002
 - a) Maximum: 8 lyriQ Zones
 - 1) Each lyriQ Zone connection can be expanded through the use of a 1x4 AU1014 to expand to 4 keypads in a single zone. Note that for this option, all keypads in the expanded zone will be set to the same source.
 - b) Maximum: 5 Distributed Sources
 - 1) Source 1-4 from 4x8 AU1002
 - 2) Source i from Integration Module HA6001
 - c) Maximum: 4 lyriQ Local Sources AU5008-xx
 - 1) Each zone can support up to 4 local sources AU5008-xx
 - iii. Connection to lyriQ 4x8 Expansion Module AU1023 (and 2 lyriQ 4x8 Modules AU1002)
 - a) Maximum: 16 lyriQ Zones
 - 1) Each lyriQ Zone connection can be expanded through the use of a 1x4 AU1014 to expand to 4 keypads in a single zone. Note that for this option, all keypads in the expanded zone will be set to the same source.
 - b) Maximum: 5 Distributed Sources
 - 1) Source 1-4 from 4x8 AU1002
 - 2) Source i from Integration Module HA6001
 - c) Maximum: 4 lyriQ Local Sources AU5008-xx
 - 1) Each zone can support up to 4 local sources AU5008-xx

2. LCD Module or Combo/Camera Module CM1048

- a. EXPANDS: Video Devices (Cameras CM5002-xx and Video Door Units IC5003-xx)
 - i. INCREASE OF: 2 cameras CM5002-xx
 - a) System Maximum: 6
 - 1) 4 cameras CM5002-xx may be serviced through the LCD Module CM1010 or Camera/Combo Module CM1048. This Module then connects to the Integration Module HA6001 through the Camera ports (uses both camera ports).
 - 2) 2 video doors IC5003-xx or cameras CM5002-xx can be connected to the Qlink Video ports.
- b. Note that these modules also allow for the connection of legacy cameras (which cannot be directly connected to the Integration Module)

3. SCI Module IC5001

- a. EXPANDS: Intercom Devices (Room Units IC5003-xx, Door Units IC5002-xx and Patio Units IC5004-xx)
 - i. INCREASE OF 8 per SCI Module IC5001
 - a) System Maximum: 32 (3 additional SCI Modules IC5001)
 - b) Note that the total number of intercom units is limited to the absolute maximum of 32.
- b. EXPANDS: Door Release Output
 - i. INCREASE OF: 1 per SCI Module IC5001
 - a) System Maximum: 4 (3 additional SCI Modules IC5001)
- c. EXPANDS: Doorbell Alert Output
 - i. INCREASE OF: 1 per SCI Module IC5001
 - a) System Maximum: 4 (3 additional SCI Modules IC5001)

4. Integration Expansion Module HA6101

- a. EXPANDS: User Interfaces (LCD Console HA5000/HA5009/HA5010-xx & TVDI HA5201-xx)
 - i. INCREASE OF 2 per Integration Expansion Module HA6101
 - a) System Maximum: 8 (3 additional Integration Expansion Module HA6101)
- b. EXPANDS: Intercom Devices (Room Units IC5003-xx, Door Units IC5002-xx and Patio Units IC5004-xx)
 - i. INCREASE OF 8 per Integration Expansion Module HA6101
 - a) System Maximum: 32 (3 additional Integration Expansion Module HA6101)
 - b) Note that the total number of intercom units is limited to the absolute maximum of 32.
 - ii. Note that the Camera Ports and Qlink Video Ports can be used for additional Intercom connections if they are not needed for video input.
- c. Note that the Qlink Video ports from the Integration Module HA6001 must be cascaded to any Integration Module Expansions HA6101 to allow for the video distribution of any devices connected to the Qlink Video Ports on the main Integration Module HA6001.
- d. Note that any cameras CM5002-xx connected to the Camera Ports on the main Integration Module HA6001 must be expanded through the use of an LCD Module CM1010 and/or Camera/Combo Module CM1048.