



Catalog Number: CT484811-SC
Item Description: 11 X 48 X 48 TRANS ENCL
UPC Code: 784572112377

Brand Name: Milbank
Type: Screw Cover
Special Features: Single Cover, Current Transformer Mounting Rack Provision
Application: Current Transformer Enclosure
Standard: UL Listed
Material: G90 Galvanized Steel with Powder Coat Finish
Cable Entry: No Knockouts
Mounting: Wall Mount
NEMA Rating: Type 3R



Utility requirements may vary. Always consult the serving utility for their requirements prior to ordering or installing this equipment. This product must always be installed by a licensed electrician. Installation of this equipment may require local electrical inspector approval.

FEATURE TABLE		
ITEM	QTY	DESCRIPTION
A	4	TRANS. MNTG.EMBOSS

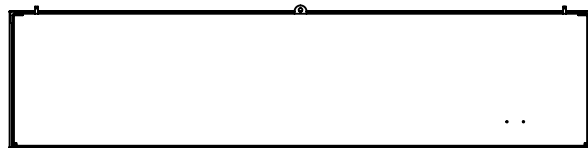
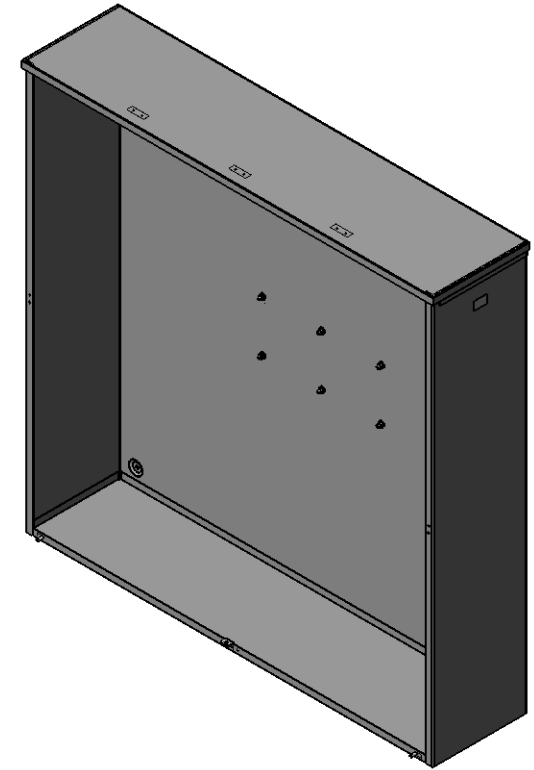
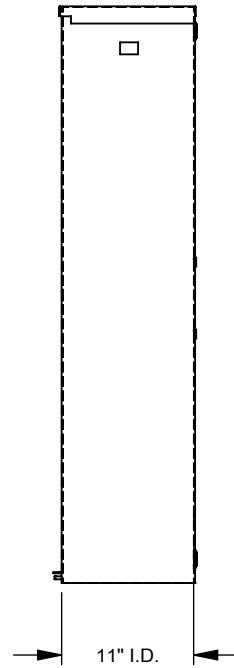
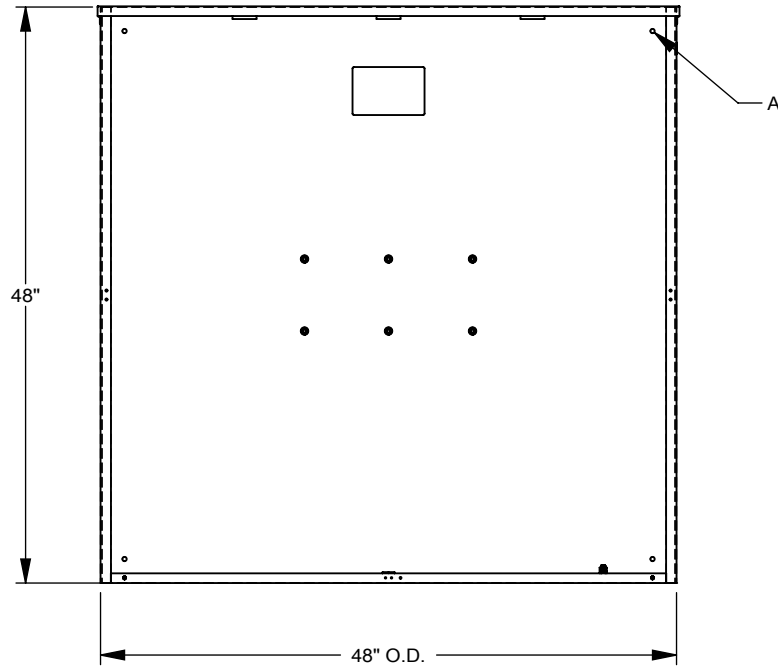

Version:

1

All dimensions are +/- 1/16".
 Drawing views are not to scale.
 Utility requirements for this equipment may vary. Always consult the serving utility for their requirements prior to ordering or installing this equipment. This product must be installed by a licensed electrician. Installation of this equipment may require local electrical inspector approval.