

KLEIN[®] TOOLS

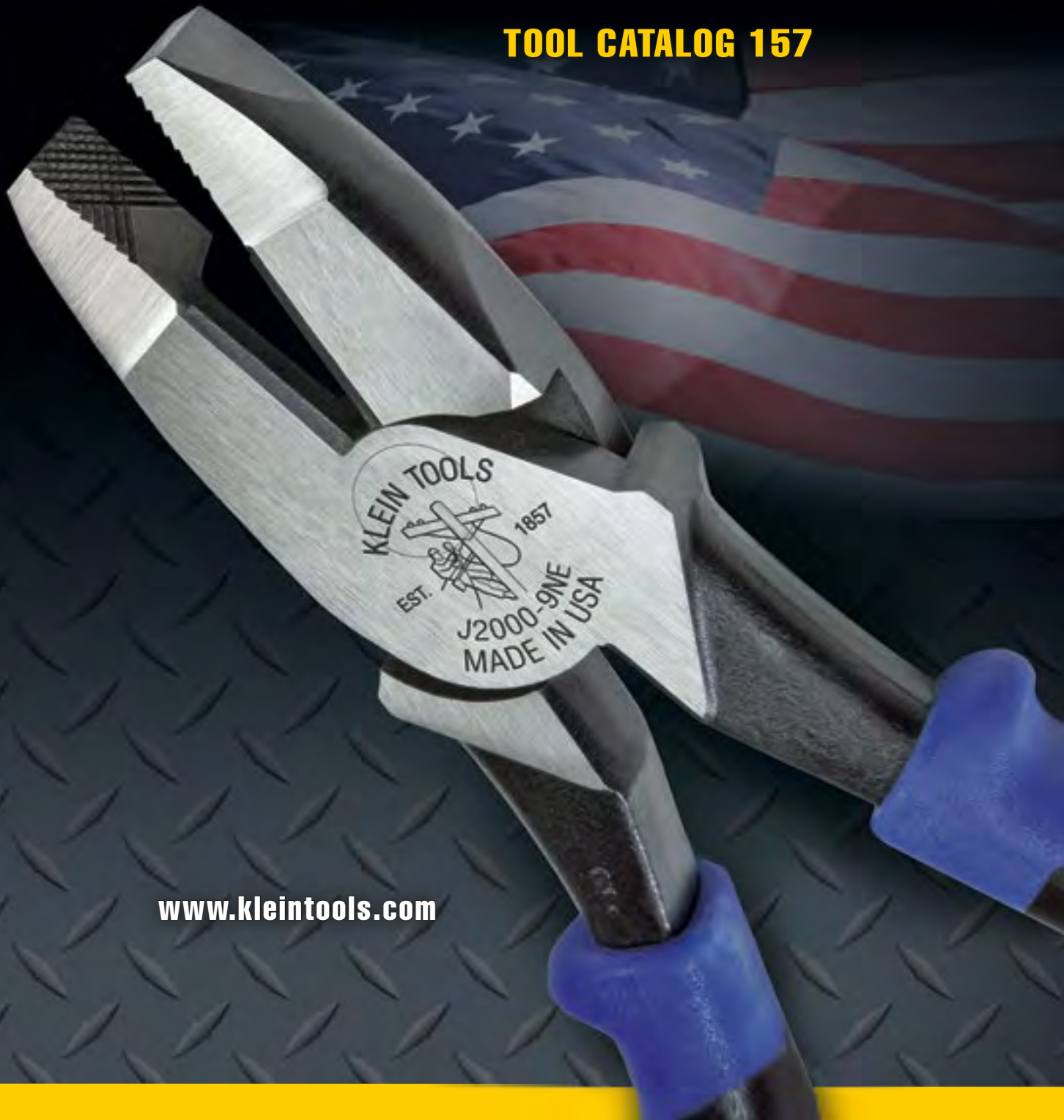

For Professionals... Since 1857[®]

TOOL CATALOG 157



www.kleintools.com

Table of Contents



Klein Pliers Pages 5–23



Journeyman™ Series Pages 24–28



Telecom Tools Pages 29–32



Voice/Data/Video Tools, Test, Kits & Connectors Pages 33–54



Strippers, Cutters & Crimpers Pages 55–61



Cable & Bolt Cutters Pages 62–69

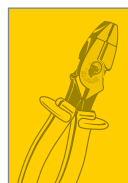

Insulated Tools Pages 70–84

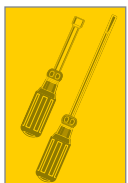

Screwdrivers, Nut Drivers & Accessories Pages 85–116

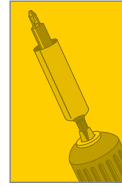

Power Tool Accessories Pages 118–121

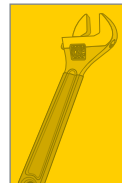

Wrenches Pages 123–138



Hex-Key Wrenches Pages 139–147



Levels & Measuring Tools Pages 148–153



Fish Tapes, Accessories & Conduit Tools Pages 154–165



Personal Protective Equipment & Safety Products Pages 167–178



Tool Pouches, Carriers, Belts & Suspenders Pages 179–198



Tool Bags & Storage Pages 200–213



Table of Contents



**Lineman Buckets
& Accessories** Pages 214–221



**Knives &
Cutting Tools** Pages 295–303

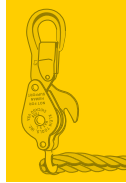

Block & Tackle Pages 222–226



**Hammers, Chisels
& Punches** Pages 304–307



**Wire Pulling
Grips** Pages 227–254



**Electrical
Test &
Measurement** Pages 308–326



**Steel Construction
Tools** Pages 255–258

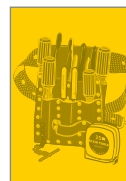

Tool Sets Pages 327–332



**Mining &
Heavy Industry
Tools** Pages 259–268

**Alphabetical
& Numeric
Indexes** Pages 333–352



**HVAC
Sheet Metal
Tools/HVAC** Pages 269–277

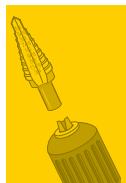

**Holemaking
Products &
Accessories** Pages 278–289

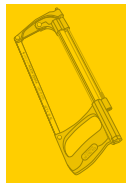

Saws & Blades Pages 291–294



Company History

Klein Tools was founded in 1857 by an industrious German immigrant, Mathias Klein, who began in the hand tool business when a broken side-cutting pliers was brought to his forge shop by a telegraph lineman. Mathias repaired the pliers by forging and finishing a new half for the tool and riveting it to the old half. Soon the lineman returned because the other original half of the pliers had broken and needed replacement. Mathias forged and finished the second half of the pliers and riveted it to the other replacement half – creating the first complete Klein pliers.

To this day, Klein Tools is proudly owned and managed by the Klein family. Over 150 years of hard work and dedication has earned Klein the reputation of supplying only the finest quality products for users of professional hand tools and occupational protective equipment.



Klein's reputation as a leading producer of professional-quality products is global. Klein Tools products are available worldwide through a well-established network of agents and distributors who stock what is needed for their particular markets.



Company History

The Professional Difference

These days, it can be hard to find companies that make products you can count on. But that's exactly what you'll get from Klein Tools.

We don't just make great products, we make great products that stand up to the demands of the professionals who use them everyday. Because our standards are as high as yours, we demand that every one of our hand tools delivers all the performance, durability and precision that you need to get the job done right.

And by using only the highest quality materials, superior workmanship, and keeping our manufacturing as close to home as we can, we're able to uphold those rigorous standards.

Klein isn't just the name of our company, it's also our family name, so we have to be proud of everything we make. And since we're an American company that's been family-owned and family-run, since 1857, you know you can count on us to be here tomorrow.

Just pick up a Klein tool and you'll know what all the professionals know...when you buy a Klein, it'll never let you down.

***That's why we're the #1 choice
of professional electricians in the US.***



Klein Pliers

Klein specializes in the making of the world's finest pliers...pliers that professionals trust completely. Klein pliers feel right and work right. They are job-matched for every kind of work you do; designed and built to exceptional quality standards in a tradition that dates back to 1857.

F O R P R O F E S S I O N A L S . . . S I N C E 1 8 5 7 ®



Pliers



Introduction – Pliers

Klein Quality

All Klein pliers are made of the finest U.S. steel alloy. They are forged, precision machined, hardened, and carefully tempered for maximum strength. Klein pliers provide exceptional performance and durability.

All pliers mating surfaces and dimensions are precision machined for faultless performance. Pliers halves are precision machined and hot riveted for uniformly smooth opening and closing action. Cutting knives are manufactured for long-lasting edges and perfect alignment.

The cutting knives on all Klein pliers are designed to meet according to the way each is used. Side-cutting and long-nose pliers with side cutters have

knives that meet at the hinge first and then meet at least one-half of the knife length. Diagonal-cutting pliers meet at the tip first and then meet at least one-half of the knife length.

These precise knife-closing designs increase knife life and facilitate resharpening.

Klein pliers are individually adjusted to meet performance standards far exceeding application requirements – ensuring that nothing less than outstanding quality ever carries the Klein name.

Using Pliers

A professional knows all the rules about using pliers, but a review of the following points may help you recall any you may have forgotten.

- 1. Never use pliers to do another tool's job.** Pliers should not be used as a hammer or pry tool or a wrench. Using pliers instead of the proper tools risks damaging the work, damaging yourself, and losing time.
- 2. Never push pliers beyond their capacity.** Bending stiff wire with light pliers or the tip of needle-nose pliers can spring them or break them. Use a stronger, blunt-nose pliers. When you need greater leverage, use pliers with greater leverage. Don't extend the length of the pliers handles. Bolts should be cut with a bolt cutter, and large cable with a cable cutter.
- 3. Never expose pliers to excessive heat.** Direct flame on metal can ruin the tool. Cutting pliers are especially vulnerable to high, direct heat.
- 4. Never cut hardened wire with ordinary pliers.** Pliers should not be used for cutting hardened wire unless they are specifically recommended for this use.
- 5. Never rock pliers from side to side when cutting wire...and never bend the wire back and forth against the cutting knives.** Either practice can dull or nick the cutting edges. Cut wire at a right angle only. If it won't cut readily, the knives may need sharpening. Or you may need pliers with greater leverage.

6. Never cut any wire or metal unless your eyes are protected. Goggles or other protective devices are an absolute must. Don't take shortcuts. Operate safely...the professional way.

7. Never cut any wire or metal unless your fellow workers' eyes are also protected. The wire that doesn't get you may get someone else. Think about the "other guy" as well as yourself.

8. Never depend on plastic-dipped handles to insulate you from electricity. Plastic-dipped and Journeyman™ handles are intended for comfort and a firmer grip only. They are not intended for protection against electric shock. Never use any pliers or cutting tools on live electrical circuits. Only use insulated tools that are marked with the official international 1000-volt rating symbol if there is any chance that the tool will make contact with an energized source.

9. Always wear approved eye protection such as protective goggles or a face mask.

Pliers Catalog Number Prefixes/Suffixes

"D" (Prefix) – Indicates the pliers have plastic-dipped handles. Plastic-dipped handles are for comfort, NOT for protection against electrical shock.

"HD" (Prefix) – Indicates the pliers have heavy-duty plastic-dipped handles. Heavy-duty plastic-dipped handles provide an extra level of user comfort and are NOT for protection against electrical shock.

"J" (Prefix) – Indicates the pliers have Journeyman™ handles. State-of-the-art dual material molding that allows for a softer, more comfortable grip on the outer surface and a harder, more durable grip on the inner surface and handle ends.

"C" (Suffix) – Indicates the pliers have a coil spring in the handles for self-opening action.

Pliers Cutting Edges

Knife-edge descriptions refer to the angle of the outside cutting edges of the knives when fully closed.

Standard Cutting Edges

Cuts hard wire. Found on all Klein side cutters, long nose, and on most diagonal-cutting pliers.

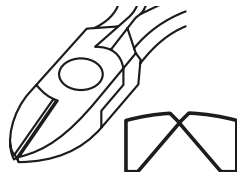

Semi-Flush Cutting Edges

Closely cuts medium wire. Found on select Klein diagonal cutting pliers.

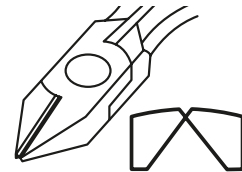

Full-Flush Cutting Edges

Close, flat cutting of soft wire only. Found on select diagonal-cutting pliers.

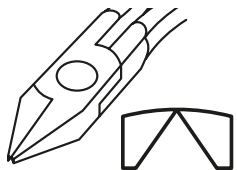

Introduction – Pliers

Pliers Dimensions

All Klein pliers are listed with necessary dimensions in both inches and millimeters. The following drawings of six basic types of pliers are keyed by letter to the dimensions given for each pliers listed. All dimensions are subject to commercial tolerances.

A – Overall Length	D – Jaw Thickness
B – Jaw Length	E – Knife Length
C – Jaw Width	F – Point Thickness

1. Side-Cutting Pliers

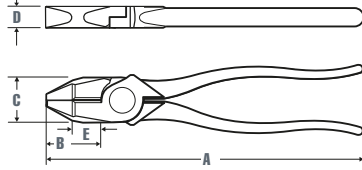

3. End-Cutting Pliers

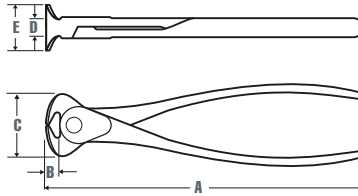

5. Flat-Nose and Duck-Bill Pliers

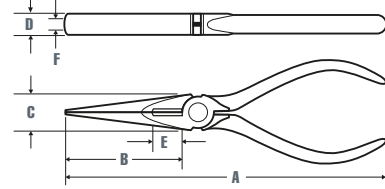

2. Diagonal-Cutting Pliers

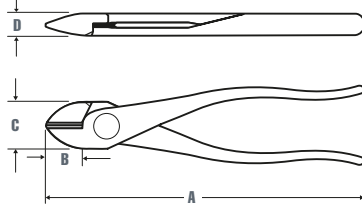

4. Long-Nose Pliers

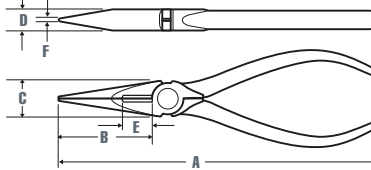

6. Curved-Nose Pliers

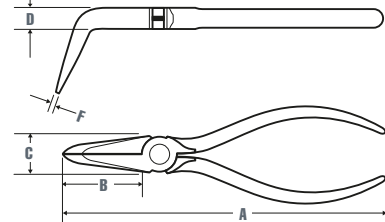

Pliers dimensions shown are accurate within accepted commercial tolerances, which allow slight variations that normally result from forging and grinding operations.

Side-Cutting Pliers

Features:

Custom, US-made tool steel.

“Handform” handles for full gripping and cutting power.

Precision-hardened plier head for on-the-job toughness.

2000 SERIES® pliers available. Cuts ACSR, screws, nails, and most hardened wire.

[†] Journeyman pliers available. State-of-the-art, dual-material handles, which provide a better grip without sacrificing tool strength or durability.

Plastic-dipped handles[†] for comfort and ease of identification.

Unique handle tempering helps absorb the “snap” when cutting wire.

Hot-riveted joint ensures smooth action and no handle wobble.

Induction hardened cutting knives for long life.

Sure-gripping cross-hatched knurled jaws.



All dimensions are in inches and (millimeters).

▲WARNING: Always wear approved eye protection.

▲WARNING: NOT insulated. Plastic-dipped or slip-on plastic handles are NOT intended for protection against electrical shock.



Side-Cutting Pliers

High-Leverage Side-Cutting Pliers – Heavy-Duty Cutting

2000 SERIES®

Additional Features:

- Cuts ACSR, screws, nails and most hardened wire.
- High-leverage design. Rivet is closer to the cutting edge for 46% greater cutting and gripping power than other plier designs.
- Streamlined design with sure-gripping, cross-hatched knurled jaws.
- Features combination polished and black-oxide finish.



D2000-9NE

Cat. No.	Nose Type	Overall Length	Jaw Length	Jaw Width	Jaw Thickness	Knife Length	Handle Finish	Handle Color	Weight (lbs.)
D2000-7	New England	7-7/8" (200 mm)	1-9/32" (33 mm)	1-1/32" (26 mm)	1/2" (13 mm)	3/4" (19 mm)	plastic-dipped	royal blue	.66
D2000-8	New England	8-11/16" (221 mm)	1-7/16" (37 mm)	1-7/64" (28 mm)	5/8" (16 mm)	3/4" (19 mm)	plastic-dipped	royal blue	.85
D2000-9NE	New England	9-3/8" (238 mm)	1-19/32" (41 mm)	1-1/4" (32 mm)	5/8" (16 mm)	25/32" (20 mm)	plastic-dipped	royal blue	1.09
HD2000-9NE	New England	9-1/2" (241 mm)	1-19/32" (41 mm)	1-1/4" (32 mm)	5/8" (16 mm)	25/32" (20 mm)	heavy-duty, oversized, plastic-dipped	light red	1.15

Journeyman™ 2000 Series – Dual-material handles

J2000-8	New England Tapered	8-13/16" (224 mm)	1-7/16" (37 mm)	1-7/64" (28 mm)	5/8" (16 mm)	3/4" (19 mm)	Journeyman	light blue/black	.93
J2000-9NE	New England	9-1/2" (241 mm)	1-19/32" (41 mm)	1-1/4" (32 mm)	5/8" (16 mm)	25/32" (20 mm)	Journeyman	light blue/black	1.13

Refer to the insulated section for insulated pliers.

High-Leverage Side-Cutting Pliers

Additional Features:

- High-leverage design. Rivet is closer to the cutting edge for 46% greater cutting and gripping power than other plier designs.
- Streamlined design with sure-gripping, cross-hatched knurled jaws.



D213-9NE

Cat. No.	Nose Type	Overall Length	Jaw Length	Jaw Width	Jaw Thickness	Knife Length	Handle Finish	Handle Color	Weight (lbs.)
D213-8NE	New England	8-11/16" (221 mm)	1-7/16" (37 mm)	1-3/16" (30 mm)	5/8" (16 mm)	23/32" (18 mm)	plastic-dipped	dark blue	.90
213-9NE	New England	9-1/4" (235 mm)	1-19/32" (41 mm)	1-1/4" (32 mm)	5/8" (16 mm)	25/32" (20 mm)	plain	n/a	1.05
D213-9NE	New England	9-3/8" (238 mm)	1-19/32" (41 mm)	1-1/4" (32 mm)	5/8" (16 mm)	25/32" (20 mm)	plastic-dipped	dark blue	1.14
HD213-9NE	New England	9-1/2" (241 mm)	1-19/32" (41 mm)	1-1/4" (32 mm)	5/8" (16 mm)	25/32" (20 mm)	heavy-duty, oversized, plastic-dipped	light red	1.15

Journeyman™ Series – Dual-material handles

J213-8NE	New England	8-13/16" (224 mm)	1-7/16" (37 mm)	1-3/16" (30 mm)	5/8" (16 mm)	23/32" (18 mm)	Journeyman	dark blue/black	0.97
J213-9NE	New England	9-1/2" (241 mm)	1-19/32" (41 mm)	1-1/4" (32 mm)	5/8" (16 mm)	25/32" (20 mm)	Journeyman	dark blue/black	1.13

Refer to the insulated section for insulated pliers.

High-Leverage Side-Cutting Pliers

Additional Features:

- High-leverage design. Rivet is closer to the cutting edge for 46% greater cutting and gripping power than other plier designs.
- Sure-gripping, cross-hatched knurled jaws.



D213-9

Cat. No.	Nose Type	Overall Length	Jaw Length	Jaw Width	Jaw Thickness	Knife Length	Handle Finish	Handle Color	Weight (lbs.)
D213-9	Square	9-3/8" (238 mm)	1-19/32" (41 mm)	1-1/4" (32 mm)	5/8" (16 mm)	25/32" (20 mm)	plastic-dipped	dark blue	1.07

All dimensions are in inches and (millimeters).

⚠WARNING: Always wear approved eye protection.

⚠WARNING: NOT insulated. Plastic-dipped or slip-on plastic handles are NOT intended for protection against electrical shock.



Side-Cutting Pliers

High-Leverage Side-Cutting Pliers – Fish Tape Pulling

Additional Features:

- Quickly and easily pulls 1/8" or 1/4" flat steel fish tape without damaging the tape.
- High-leverage design. Rivet is closer to the cutting edge for 46% greater cutting and gripping power than other plier designs.
- Streamlined design with sure-gripping, cross-hatched knurled jaws.



D213-9NETP

Cat. No.	Nose Type	Overall Length	Jaw Length	Jaw Width	Jaw Thickness	Knife Length	Handle Finish	Handle Color	Weight (lbs.)
D213-9NETP	New England	9-3/8" (238 mm)	1-19/32" (41 mm)	1-1/4" (32 mm)	5/8" (16 mm)	25/32" (20 mm)	plastic-dipped	dark blue	1.06
Journeyman™ Series – Dual-material handles									
J213-9NETP	New England	9-1/2" (241 mm)	1-19/32" (41 mm)	1-1/4" (32 mm)	5/8" (16 mm)	25/32" (20 mm)	Journeyman	dark blue/black	1.11
2000 Series* – Heavy-duty cutting knives									
D2000-9NETP	New England	9-3/8" (238 mm)	1-19/32" (41 mm)	1-1/4" (32 mm)	5/8" (16 mm)	25/32" (20 mm)	plastic-dipped	royal blue	1.09
Journeyman™ 2000 Series* – Dual-material handles									
J2000-9NETP	New England	9-1/2" (241 mm)	1-19/32" (41 mm)	1-1/4" (32 mm)	5/8" (16 mm)	25/32" (20 mm)	Journeyman	light blue/black	1.14

*Cuts ACSR, screws, nails, and most hardened wire. Features combination polished and black-oxide finish.

High-Leverage Side-Cutting Pliers – Lineman's Bolt-Thread Holding

Additional Features:

- Hinge opening holds and cleans 5/8" pole line and hardware bolts or threaded rods.
- High-leverage design. Rivet is closer to the cutting edge for 46% greater cutting and gripping power than other plier designs.
- Streamlined design with rounded nose and sure-gripping, cross-hatched knurled jaw.



D213-9NETH

Cat. No.	Nose Type	Overall Length	Jaw Length	Jaw Width	Jaw Thickness	Knife Length	Handle Finish	Handle Color	Weight (lbs.)
D213-9NETH	New England	9-3/8" (238 mm)	1-19/32" (41 mm)	1-1/4" (32 mm)	5/8" (16 mm)	25/32" (20 mm)	plastic-dipped	dark blue	1.12
HD213-9NETH	New England	9-1/2" (241 mm)	1-19/32" (41 mm)	1-1/4" (32 mm)	5/8" (16 mm)	25/32" (20 mm)	heavy-duty, oversized, plastic-dipped	light red	1.18
2000 Series* – Heavy-duty cutting knives									
D2000-9NETH	New England	9-3/8" (238 mm)	1-19/32" (41 mm)	1-1/4" (32 mm)	5/8" (16 mm)	25/32" (20 mm)	plastic-dipped	royal blue	1.18

*Cuts ACSR, screws, nails, and most hardened wire. Features combination polished and black-oxide finish.

High-Leverage Side-Cutting Pliers – Connector Crimping

Additional Features:

- Crimping die behind hinge for superior leverage crimping of non-insulated connectors, lugs and terminals.
- High-leverage design. Rivet is closer to the cutting edge for 46% greater cutting and gripping power than other plier designs.
- Streamlined design with rounded nose and sure-gripping, cross-hatched knurled jaws.



D213-9NECR

Cat. No.	Nose Type	Overall Length	Jaw Length	Jaw Width	Jaw Thickness	Knife Length	Handle Finish	Handle Color	Weight (lbs.)
D213-9NECR	New England	9-3/8" (238 mm)	1-19/32" (41 mm)	1-1/4" (32 mm)	5/8" (16 mm)	25/32" (20 mm)	plastic-dipped	yellow	1.08
Journeyman™ Series – Dual-material handles									
J213-9NECR	New England	9-1/2" (241 mm)	1-19/32" (41 mm)	1-1/4" (32 mm)	5/8" (16 mm)	25/32" (20 mm)	Journeyman	yellow/black	1.13
2000 Series* – Heavy-duty cutting knives									
D2000-9NECR	New England	9-3/8" (238 mm)	1-19/32" (41 mm)	1-1/4" (32 mm)	5/8" (16 mm)	25/32" (20 mm)	plastic-dipped	royal blue	1.08
Journeyman™ 2000 Series* – Dual-material handles									
J2000-9NECR	New England	9-1/2" (241 mm)	1-19/32" (41 mm)	1-1/4" (32 mm)	5/8" (16 mm)	25/32" (20 mm)	Journeyman	light blue/black	1.12

*Cuts ACSR, screws, nails, and most hardened wire. Features combination polished and black-oxide finish. Refer to the insulated section for insulated pliers.

All dimensions are in inches and (millimeters).

▲WARNING: Always wear approved eye protection.

▲WARNING: NOT insulated. Plastic-dipped or slip-on plastic handles are NOT intended for protection against electrical shock.

Side-Cutting Pliers

Side-Cutting Pliers

Additional Feature:

- Sure-gripping, cross-hatched knurled jaws.



D201-9NE

Cat. No.	Nose Type	Overall Length	Jaw Length	Jaw Width	Jaw Thickness	Knife Length	Handle Finish	Handle Color	Weight (lbs.)
Streamlined Design									
D201-7NE	New England	7-7/16" (189 mm)	1-9/32" (33 mm)	1-1/16" (27 mm)	1/2" (13 mm)	5/8" (16 mm)	plastic-dipped	dark blue	.55
D201-8NE	New England	8-11/16" (221 mm)	1-7/16" (37 mm)	1-3/16" (30 mm)	5/8" (16 mm)	23/32" (18 mm)	plastic-dipped	dark blue	.92
D201-9NE	New England	9-3/8" (238 mm)	1-19/32" (41 mm)	1-5/16" (33 mm)	5/8" (16 mm)	25/32" (20 mm)	plastic-dipped	dark blue	1.09
Square Nose									
D201-8	Square	8-11/16" (221 mm)	1-7/16" (37 mm)	1-7/32" (31 mm)	5/8" (16 mm)	23/32" (18 mm)	plastic-dipped	dark blue	.93
D201-9	Square	9-3/8" (238 mm)	1-19/32" (41 mm)	1-5/16" (33 mm)	5/8" (16 mm)	25/32" (20 mm)	plastic-dipped	dark blue	1.10

High-Leverage Universal Combination Pliers

Additional Features:

- Crimping die behind hinge for superior leverage crimping non-insulated connectors, lugs and terminals.
- Toothed pipe-grip for greater gripping power.



12098

Cat. No.	Nose Type	Overall Length	Jaw Length	Jaw Width	Jaw Thickness	Knife Length	Handle Finish	Handle Color	Weight (lbs.)
12098	Universal	8-5/8" (219 mm)	1-25/32" (45 mm)	1-1/32" (26 mm)	17/32" (13 mm)	3/4" (19 mm)	plastic-dipped	dark blue	.72
Journeyman™ Series – Dual-material handles									
J12098	Universal	8-3/4" (222 mm)	1-25/32" (45 mm)	1-1/32" (26 mm)	17/32" (13 mm)	3/4" (19 mm)	Journeyman	dark blue/black	.82

Refer to the insulated section for insulated pliers.

Ironworker's Work Pliers – High-Leverage

Additional Features:

- Twists and cuts soft annealed rebar tie wire.
- High-leverage design. Rivet is closer to the cutting edge for 46% greater cutting and gripping power than other plier designs.
- Hook bend handle.
- Spring-loaded action for self-opening.
- Heavy-duty knurled jaws.



D213-9ST

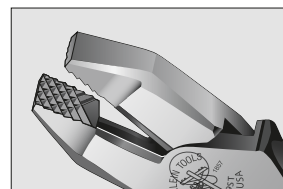

Cat. No.	Nose Type	Overall Length	Jaw Length	Jaw Width	Jaw Thickness	Knife Length	Handle Finish	Handle Color	Weight (lbs.)
213-9ST	Square	9-1/4" (235 mm)	1-19/32" (41 mm)	1-1/4" (32 mm)	5/8" (16 mm)	25/32" (20 mm)	plain	n/a	1.02
D213-9ST	Square	9-3/8" (238 mm)	1-19/32" (41 mm)	1-1/4" (32 mm)	5/8" (16 mm)	25/32" (20 mm)	plastic-dipped	dark blue	1.10
2000 Series* – Heavy-duty cutting knives									
D2000-9ST	Square	9-3/8" (238 mm)	1-19/32" (41 mm)	1-1/4" (32 mm)	5/8" (16 mm)	25/32" (20 mm)	plastic-dipped	royal blue	1.10

*Cuts ACSR, screws, nails, and most hardened wire. Features combination polished and black-oxide finish.

All dimensions are in inches and (millimeters).

WARNING: Always wear approved eye protection.

WARNING: NOT insulated. Plastic-dipped or slip-on plastic handles are NOT intended for protection against electrical shock.



Side-Cutting Pliers

Ironworker's Work Pliers

Additional Features:

- Twists and cuts soft annealed rebar tie wire.
- Hook bend handle.
- Spring-loaded action for self-opening.
- Heavy-duty knurled jaws.



D201-7CST

Cat. No.	Nose Type	Overall Length	Jaw Length	Jaw Width	Jaw Thickness	Knife Length	Handle Finish	Handle Color	Weight (lbs.)
201-7CST	Square	9-1/8" (232 mm)	1-9/32" (33 mm)	1-5/32" (29 mm)	1/2" (13 mm)	5/8" (16 mm)	plain	n/a	.65
D201-7CST	Square	9-1/4" (235 mm)	1-9/32" (33 mm)	1-5/32" (29 mm)	1/2" (13 mm)	5/8" (16 mm)	plastic-dipped	dark blue	.75
2000 Series* – Heavy-duty cutting knives									
D2000-7CST	Square	9-1/4" (235 mm)	1-9/32" (33 mm)	1-5/32" (29 mm)	1/2" (13 mm)	5/8" (16 mm)	plastic-dipped	royal blue	.70

*Cuts ACSR, screws, nails, and most hardened wire. Features combination polished and black-oxide finish.

Diagonal-Cutting Pliers

Features:

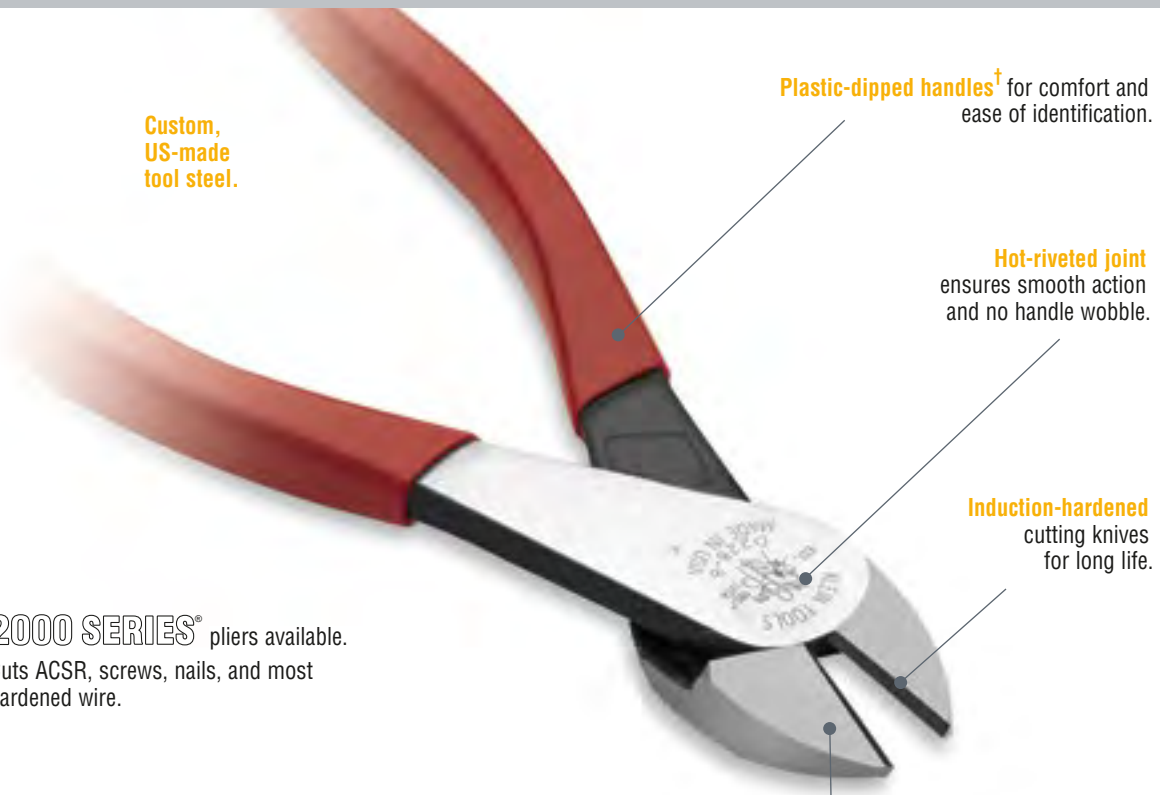

Custom, US-made tool steel.

Plastic-dipped handles[†] for comfort and ease of identification.

Hot-riveted joint ensures smooth action and no handle wobble.

Induction-hardened cutting knives for long life.

Short jaws and beveled cutting edges permit close cutting of wire.

2000 SERIES[®] pliers available. Cuts ACSR, screws, nails, and most hardened wire.



[†]Journeyman pliers available. State-of-the-art, dual-material handles, which provide a better grip without sacrificing tool strength or durability.



Pliers

All dimensions are in inches and (millimeters).

▲WARNING: Always wear approved eye protection.

▲WARNING: NOT insulated. Plastic-dipped or slip-on plastic handles are NOT intended for protection against electrical shock.

Diagonal-Cutting Pliers

High-Leverage Diagonal-Cutting Pliers

Additional Feature:

- High-leverage design. Rivet is closer to the cutting edge for 36% greater cutting power than other plier designs.



D2000-28

Cat. No.	Overall Length	Jaw Length	Jaw Width	Jaw Thickness	Cutting Knives	Handle Finish	Handle Color	Weight (lbs.)
D228-7	7-1/8" (181 mm)	13/16" (21 mm)	1-3/16" (30 mm)	7/16" (11 mm)	standard	plastic-dipped	red	.54
D228-8	8-1/16" (205 mm)	13/16" (21 mm)	1-3/16" (30 mm)	7/16" (11 mm)	standard	plastic-dipped	red	.60
Journeyman™ Series – Dual-material handles								
J228-8	8-1/8" (206 mm)	13/16" (21 mm)	1-3/16" (30 mm)	7/16" (11 mm)	standard	Journeyman	red/black	.67
2000 Series* – Heavy-duty cutting knives								
D2000-28	8-1/16" (205 mm)	13/16" (21 mm)	1-3/16" (30 mm)	7/16" (11 mm)	standard	plastic-dipped	royal blue	.60
Journeyman™ 2000 Series* – Dual-material handles								
J2000-28	8-1/8" (206 mm)	13/16" (21 mm)	1-3/16" (30 mm)	7/16" (11 mm)	standard	Journeyman	light blue/black	.67

*Cuts ACSR, screws, nails, and most hardened wire. Features combination polished and black-oxide finish. Refer to the insulated section for insulated pliers.

High-Leverage Diagonal-Cutting Pliers – Angled Head

Additional Features:

- Angled head design for easy work in confined spaces.
- High-leverage design. Rivet is closer to the cutting edge for 36% greater cutting power than other plier designs.



D2000-48



Cat. No.	Overall Length	Jaw Length	Jaw Width	Jaw Thickness	Cutting Knives	Handle Finish	Handle Color	Weight (lbs.)
D248-8	8-1/16" (205 mm)	13/16" (21 mm)	1-3/16" (30 mm)	7/16" (11 mm)	standard	plastic-dipped	red	.60
D238-8	8-1/16" (205 mm)	13/16" (21 mm)	1-3/16" (30 mm)	7/16" (11 mm)	semi-flush**	plastic-dipped	red	.59
Journeyman Series – Dual-material handles								
J248-8	8-1/8" (206 mm)	13/16" (21 mm)	1-3/16" (30 mm)	7/16" (11 mm)	standard	Journeyman	red/black	.61
2000 Series* – Heavy-duty cutting knives								
D2000-48	8-1/16" (205 mm)	13/16" (21 mm)	1-3/16" (30 mm)	7/16" (11 mm)	standard	plastic-dipped	royal blue	.60
Journeyman 2000 Series* – Dual-material handles								
J2000-48	8-1/8" (206 mm)	13/16" (21 mm)	1-3/16" (30 mm)	7/16" (11 mm)	standard	Journeyman	light blue/black	.61

*Cuts ACSR, screws, nails, and most hardened wire. Features combination polished and black-oxide finish.

**Semi-flush cutting knives cut Cherry Burrel rivets. For use on non-ferrous wire only.

Refer to the insulated section for insulated pliers.

High-Leverage Diagonal-Cutting Pliers – Stripping Holes

Additional Features:

- Cleanly strips 12 and 14 solid AWG wire.
- High-leverage design. Rivet is closer to the cutting edge for 36% greater cutting power than other plier designs.



SOLID
12 – 14 AWG

D243-8

Cat. No.	Overall Length	Jaw Length	Jaw Width	Jaw Thickness	Cutting Knives	Handle Finish	Handle Color	Weight (lbs.)
D243-8	8-1/16" (205 mm)	13/16" (21 mm)	1-3/16" (30 mm)	7/16" (11 mm)	standard	plastic-dipped	red	.60

All dimensions are in inches and (millimeters).

⚠WARNING: Always wear approved eye protection.

⚠WARNING: NOT insulated. Plastic-dipped or slip-on plastic handles are NOT intended for protection against electrical shock.



Diagonal-Cutting Pliers

High-Leverage Diagonal-Cutting Pliers – Ironworker’s

Additional Features:

- Angled head design for easy working in confined spaces.
- Hooked handle for improved grip.
- High-leverage design. Rivet is closer to the cutting edge for 36% greater cutting power than other plier designs.



D248-9ST

Cat. No.	Overall Length	Jaw Length	Jaw Width	Jaw Thickness	Cutting Knives	Handle Finish	Handle Color	Weight (lbs.)
D248-9ST	9-3/16" (233 mm)	13/16" (21 mm)	1-3/16" (30 mm)	7/16" (11 mm)	standard	plastic-dipped	red	.68

Heavy-Duty Diagonal-Cutting Pliers – Tapered Nose

Additional Features:

- Heavy-duty tapered nose design.
- One-inch jaws easily reach into confined spaces.



D220-7

Cat. No.	Overall Length	Jaw Length	Jaw Width	Jaw Thickness	Cutting Knives	Handle Finish	Handle Color	Weight (lbs.)
D220-7	7-11/16" (195 mm)	1" (25 mm)	31/32" (25 mm)	1/2" (13 mm)	standard	plastic-dipped	red	.54

Refer to the insulated section for insulated pliers.

Heavy-Duty Diagonal-Cutting Pliers – All Purpose

Additional Features:

- Heavier design for all-purpose use.
- Tapered nose for easy working in confined areas.



D252-6

Cat. No.	Overall Length	Jaw Length	Jaw Width	Jaw Thickness	Cutting Knives	Handle Finish	Handle Color	Weight (lbs.)
D252-6	6-1/8" (156 mm)	13/16" (21 mm)	3/4" (19 mm)	7/16" (11 mm)	standard	plastic-dipped	red	.38

Bell System Type "W" Notches – Slit insulation cleanly

D252-6SW	6-1/8" (156 mm)	13/16" (21 mm)	3/4" (19 mm)	7/16" (11 mm)	standard	plastic-dipped	red	.33
----------	-----------------	----------------	--------------	---------------	----------	----------------	-----	-----

Standard Diagonal-Cutting Pliers – Tapered Nose

Additional Feature:

- Easy working in confined areas.
- Spring-loaded action for self-opening (Cat. No. D202-6C).



D202-6

Cat. No.	Overall Length	Jaw Length	Jaw Width	Jaw Thickness	Cutting Knives	Handle Finish	Handle Color	Weight (lbs.)
D202-6	6-1/8" (156 mm)	13/16" (21 mm)	11/16" (18 mm)	7/16" (11 mm)	standard	plastic-dipped	red	.29
D202-6C	6-1/8" (156 mm)	13/16" (21 mm)	11/16" (18 mm)	7/16" (11 mm)	standard	plastic-dipped	red	.31

Standard Diagonal-Cutting Pliers – Tapered Nose

Additional Feature:

- Tapered nose for easy working in confined areas and close tip cutting.
- Spring-loaded action for self-opening (Cat. No. D245-5C).



D245-5

Cat. No.	Overall Length	Jaw Length	Jaw Width	Jaw Thickness	Cutting Knives	Handle Finish	Handle Color	Weight (lbs.)
D245-5	5-1/16" (129 mm)	11/16" (18 mm)	9/16" (14 mm)	3/8" (10 mm)	standard	plastic-dipped	red	.20
D245-5C	5-1/16" (129 mm)	11/16" (18 mm)	9/16" (14 mm)	3/8" (10 mm)	standard	plastic-dipped	red	.20

All dimensions are in inches and (millimeters).

▲WARNING: Always wear approved eye protection.

▲WARNING: NOT insulated. Plastic-dipped or slip-on plastic handles are NOT intended for protection against electrical shock.



Diagonal-Cutting Pliers

Standard Diagonal-Cutting Pliers – Semi-Flush Cutting

Additional Features:

- Trims plastic or printed circuit boards.
- Spring-loaded for self-opening action.



D210-6C

Cat. No.	Overall Length	Jaw Length	Jaw Width	Jaw Thickness	Cutting Knives	Handle Finish	Handle Color	Weight (lbs.)
D210-6C	6-1/8" (156 mm)	13/16" (21 mm)	11/16" (18 mm)	7/16" (11 mm)	semi-flush	plastic-dipped	red	.29

Standard Diagonal-Cutting Pliers – Stripping Hole

Additional Features:

- Cleanly strips 16 AWG (1.0 mm) solid wire.
- Tapered nose for easy working in confined areas.

SOLID
16 AWG



D240-6

Cat. No.	Overall Length	Jaw Length	Jaw Width	Jaw Thickness	Cutting Knives	Handle Finish	Handle Color	Weight (lbs.)
D240-6	6-1/8" (156 mm)	13/16" (21 mm)	11/16" (18 mm)	7/16" (11 mm)	standard	plastic-dipped	red	.30

Diagonal-Cutting Electronics Pliers

Diagonal-Cutting Pliers – Pointed Nose, Narrow Jaws

Additional Features:

- Narrow jaw and hinge for delicate work in tight areas.
- Sharp pointed nose for precise tip cutting.
- Spring-loaded action for self-opening.



D244-5C

Cat. No.	Overall Length	Jaw Length	Jaw Width	Jaw Thickness	Cutting Knives	Handle Finish	Handle Color	Weight (lbs.)
D244-5C	5-1/16" (129 mm)	11/16" (18 mm)	1/2" (13 mm)	5/16" (8 mm)	flush	plastic-dipped	royal blue	.18

Midget Standard Diagonal-Cutting Pliers

Additional Feature:

- Tapered nose for easy working in confined areas and close tip cutting.
- Spring-loaded action for self-opening (Cat. No. D257-4C).



D257-4C

Cat. No.	Overall Length	Jaw Length	Jaw Width	Jaw Thickness	Cutting Knives	Handle Finish	Handle Color	Weight (lbs.)
D257-4	4-1/4" (108 mm)	1/2" (13 mm)	7/16" (11 mm)	1/4" (6 mm)	semi-flush	plastic-dipped	royal blue	.12
D257-4C	4-1/4" (108 mm)	1/2" (13 mm)	7/16" (11 mm)	1/4" (6 mm)	semi-flush	plastic-dipped	royal blue	.12

All dimensions are in inches and (millimeters).

▲WARNING: Always wear approved eye protection.

▲WARNING: NOT insulated. Plastic-dipped or slip-on plastic handles are NOT intended for protection against electrical shock.



Diagonal-Cutting Electronics Pliers

Midget Diagonal-Cutting Pliers – Pointed Nose

Additional Features:

- Sharp pointed nose for precise tip cutting and trimming printed circuit boards.
- Spring-loaded for self-opening action.



D209-5C

Cat. No.	Overall Length	Jaw Length	Jaw Width	Jaw Thickness	Cutting Knives	Handle Finish	Handle Color	Weight (lbs.)
D209-4C	4-1/4" (108 mm)	1/2" (13 mm)	7/16" (11 mm)	1/4" (6 mm)	semi-flush	plastic-dipped	royal blue	.13
D209-5C	5-1/16" (129 mm)	11/16" (18 mm)	9/16" (14 mm)	3/8" (10 mm)	semi-flush	plastic-dipped	royal blue	.19

Midget Diagonal-Cutting Pliers – Pointed Nose, Extra Narrow Jaws

Additional Features:

- Narrow jaw and hinge for delicate work in tight areas.
- Sharp pointed nose for precise tip cutting.
- Spring-loaded action for self-opening.



D259-4C

Cat. No.	Overall Length	Jaw Length	Jaw Width	Jaw Thickness	Cutting Knives	Handle Finish	Handle Color	Weight (lbs.)
D259-4C	4-1/4" (108 mm)	1/2" (13 mm)	13/32" (10 mm)	1/4" (6 mm)	flush	plastic-dipped	royal blue	.12

Midget Diagonal-Cutting Pliers – Tapered Nose, Midget Jaws

Additional Features:

- Miniature jaw for close-quarter work with maximum visibility.
- Sharp pointed nose for precise tip cutting.
- Spring-loaded action for self-opening.



D295-4C

Cat. No.	Overall Length	Jaw Length	Jaw Width	Jaw Thickness	Cutting Knives	Handle Finish	Handle Color	Weight (lbs.)
D295-4C	4-1/4" (108 mm)	1/2" (13 mm)	3/8" (10 mm)	1/4" (6 mm)	flush	plastic-dipped	royal blue	.11

Midget Diagonal-Cutting Pliers – Nickel Ribbon Wire Cutters

Additional Features:

- Designed to cut nickel ribbon wire.
- Nose tip is only 1/32" (0.8 mm) for precise work in confined areas.
- Cutting knife tip is 3/16" (5 mm) long for precise cutting.
- Spring-loaded action for self-opening.



D230-4C

Cat. No.	Overall Length	Jaw Length	Jaw Width	Jaw Thickness	Cutting Knives	Handle Finish	Handle Color	Weight (lbs.)
D230-4C	4-1/4" (108 mm)	1/2" (13 mm)	7/16" (11 mm)	1/4" (6 mm)	semi-flush	plastic-dipped	royal blue	.12

Lightweight Flush Cutter

Additional Features:

- Shears wire up to 18 AWG producing a flat, flush cut.
- Shear cutting greatly reduces cutting effort and minimizes fly-off.
- Cushioned grips and steel return spring for increased comfort during repetitive cutting.
- Ultra slim profile increases access in confined areas.
- Heat treated for increased durability.



D275-5

Cat. No.	Overall Length	Cutting Knives	Handle Finish	Handle Color	Weight (lbs.)
D275-5	5" (127 mm)	flush	plastic	red	.11

All dimensions are in inches and (millimeters).

▲WARNING: Always wear approved eye protection.

▲WARNING: NOT insulated. Plastic-dipped or slip-on plastic handles are NOT intended for protection against electrical shock.



Long-Nose Pliers

Features:

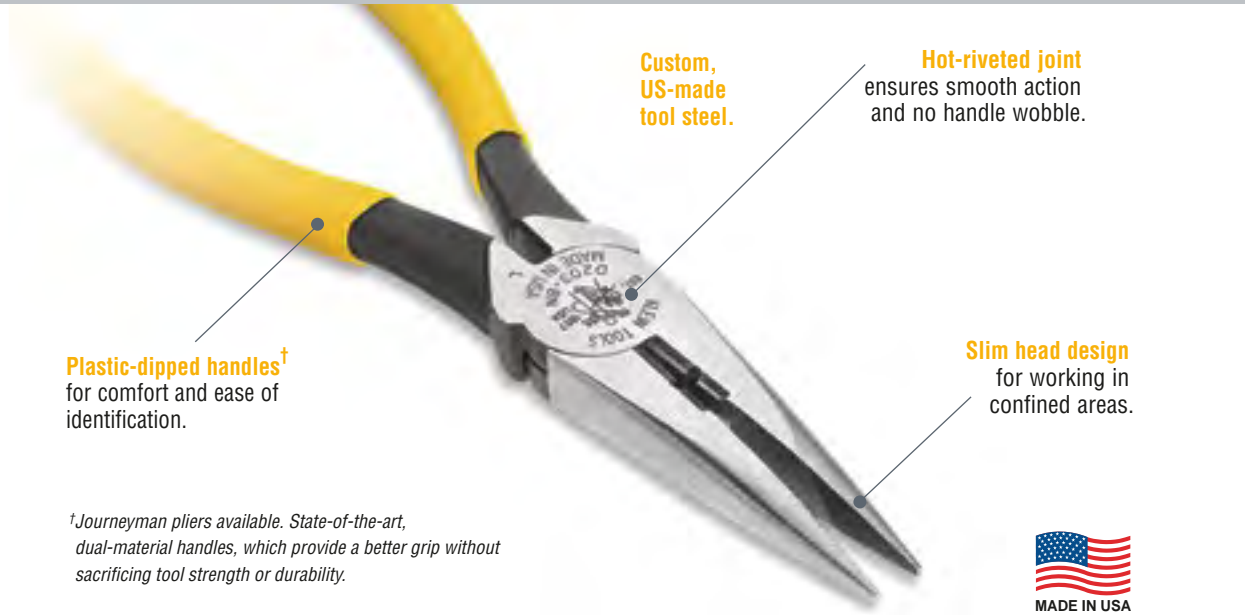

†Journeyman pliers available. State-of-the-art, dual-material handles, which provide a better grip without sacrificing tool strength or durability.



Pliers

All-Purpose Pliers

JOURNEYMAN™

NEW!

Additional Features:

- Strips 8-16 AWG Solid and 10-18 AWG Stranded wire.
- Induction-hardened cutting knives for increased wire cutting performance, including hard wire.
- Long nose for grabbing and looping wire.
- 6-32 and 8-32 screw shearing.
- Dual material Journeyman™ handles provide better grip.



Cat. No.	Overall Length	Jaw Length	Jaw Width	Jaw Thickness	Knife Length	Point Thickness	Handle Finish	Handle Color	Weight (lbs.)
J206-8C	8-5/8" (214 mm)	2-3/16" (59 mm)	1" (25 mm)	1/2" (13 mm)	1/2" (13 mm)	1/8" (3 mm)	Journeyman	yellow/gray	.60

Heavy-Duty Long-Nose Pliers – Side-Cutting

Additional Features:

- Induction-hardened cutting knives for long life.
- Heavier design for greater cutting power.
- Extended handles provide added reach and leverage.



Cat. No.	Overall Length	Jaw Length	Jaw Width	Jaw Thickness	Knife Length	Point Thickness	Handle Finish	Handle Color	Weight (lbs.)
D203-8	8-7/16" (214 mm)	2-5/16" (59 mm)	1" (25 mm)	1/2" (13 mm)	5/8" (16 mm)	1/8" (3 mm)	plastic-dipped	yellow	.60

Journeyman™ Series – Dual-material handles

J203-8	8-9/16" (218 mm)	2-5/16" (59 mm)	1" (25 mm)	1/2" (13 mm)	5/8" (16 mm)	1/8" (3 mm)	Journeyman	yellow/black	.63
--------	------------------	-----------------	------------	--------------	--------------	-------------	------------	--------------	-----

Wire Stripping – Cleanly strips 12 AWG wire

D203-8N	8-7/16" (214 mm)	2-5/16" (59 mm)	1" (25 mm)	1/2" (13 mm)	5/8" (16 mm)	1/8" (3 mm)	plastic-dipped	yellow	.59
---------	------------------	-----------------	------------	--------------	--------------	-------------	----------------	--------	-----

Journeyman™ Series – Dual-material handles

J203-8N	8-9/16" (218 mm)	2-5/16" (59 mm)	1" (25 mm)	1/2" (13 mm)	5/8" (16 mm)	1/8" (3 mm)	Journeyman	yellow/black	.64
---------	------------------	-----------------	------------	--------------	--------------	-------------	------------	--------------	-----

Wire Stripping & Crimping – Cleanly strips 12 AWG wire; crimps connectors, lugs & terminals

D203-8NCR	8-7/16" (214 mm)	2-5/16" (59 mm)	1" (25 mm)	1/2" (13 mm)	5/8" (16 mm)	1/8" (3 mm)	plastic-dipped	yellow	.61
-----------	------------------	-----------------	------------	--------------	--------------	-------------	----------------	--------	-----

Refer to the insulated section for insulated pliers.

All dimensions are in inches and (millimeters).

⚠WARNING: Always wear approved eye protection.

⚠WARNING: NOT insulated. Plastic-dipped or slip-on plastic handles are NOT intended for protection against electrical shock.



Long-Nose Pliers

Standard Long-Nose Pliers – Side-Cutting

Additional Features:

- Induction-hardened, long-lasting cutting knives.
- Knurled jaws for sure wrapping and looping.
- Curved handles provide greater tool control.
- Spring-loaded action for self-opening (Cat. Nos. D203-6C, D203-7C).



D203-6C

Cat. No.	Overall Length	Jaw Length	Jaw Width	Jaw Thickness	Knife Length	Point Thickness	Handle Finish	Handle Color	Weight (lbs.)
D203-6	6-5/8" (168 mm)	1-7/8" (48 mm)	11/16" (18 mm)	3/8" (10 mm)	1/2" (13 mm)	3/32" (2 mm)	plastic-dipped	yellow	.27
D203-6C	6-5/8" (168 mm)	1-7/8" (48 mm)	11/16" (18 mm)	3/8" (10 mm)	1/2" (13 mm)	3/32" (2 mm)	plastic-dipped	yellow	.27
D203-7	7-3/16" (183 mm)	2-7/16" (62 mm)	11/16" (18 mm)	3/8" (10 mm)	1/2" (13 mm)	3/32" (2 mm)	plastic-dipped	yellow	.29
D203-7C	7-3/16" (183 mm)	2-7/16" (62 mm)	11/16" (18 mm)	3/8" (10 mm)	1/2" (13 mm)	3/32" (2 mm)	plastic-dipped	yellow	.29
Journeyman™ Series – Dual-material handles									
J203-6	6-3/4" (171 mm)	1-7/8" (48 mm)	11/16" (18 mm)	3/8" (10 mm)	1/2" (13 mm)	3/32" (2 mm)	Journeyman	yellow/black	.30
J203-7	7-5/16" (186 mm)	2-7/16" (62 mm)	11/16" (18 mm)	3/8" (10 mm)	1/2" (13 mm)	3/32" (2 mm)	Journeyman	yellow/black	.33
Switchboard Work – Cleanly strips 19 & 22 AWG wire									
D203-6H2	6-5/8" (168 mm)	1-7/8" (48 mm)	11/16" (18 mm)	3/8" (10 mm)	1/2" (13 mm)	3/32" (2 mm)	plastic-dipped	yellow	.26

Refer to the insulated section for insulated pliers.

Standard Long-Nose Pliers

Additional Features:

- Knurled jaws for sure wrapping and looping.
- Curved handles provide greater tool control.
- Spring-loaded action for self-opening (Cat. No. D301-6C).



D301-6

Cat. No.	Overall Length	Jaw Length	Jaw Width	Jaw Thickness	Point Thickness	Handle Finish	Handle Color	Weight (lbs.)
D301-6	6-5/8" (168 mm)	1-7/8" (48 mm)	11/16" (18 mm)	3/8" (10 mm)	3/32" (2 mm)	plastic-dipped	yellow	.29
D301-6C	6-5/8" (168 mm)	1-7/8" (48 mm)	11/16" (18 mm)	3/8" (10 mm)	3/32" (2 mm)	plastic-dipped	yellow	.28

Long-Reach Long-Nose Pliers

Additional Features:

- Long handles and nose allow greater access to confined, hard-to-reach areas.
- Long-reach design provides greater holding power at the tip with minimal effort.
- Mating surfaces and dimensions are precision machined for faultless tool performance.
- Pliers are hot riveted for uniformly smooth opening and closing action.
- Knurled jaws for precise gripping and sure wrapping and looping of wire.
- Custom US tool steel is forged, precision machined, hardened and tempered for maximum strength, exceptional performance, and long life.
- Plastic-dipped yellow handles are comfortable and easy to identify.
- Pliers are individually adjusted to meet performance standards far exceeding application requirements.
- 45° bent style reaches around obstructions (Cat. No. D362-11).



D360-11



D362-11

Cat. No.	Nose Angle	Overall Length	Jaw Length	Jaw Width	Jaw Thickness	Point Thickness	Handle Finish	Handle Color	Weight (lbs.)
D360-11	straight	11-1/16" (281 mm)	2-7/16" (62 mm)	23/32" (18 mm)	13/32" (10 mm)	1/8" (3 mm)	plastic-dipped	yellow	.62
D362-11	45°	10-11/16" (271 mm)	2-3/32" (53 mm)	23/32" (18 mm)	13/32" (10 mm)	1/8" (3 mm)	plastic-dipped	yellow	.62

All dimensions are in inches and (millimeters).

▲WARNING: Always wear approved eye protection.

▲WARNING: NOT insulated. Plastic-dipped or slip-on plastic handles are NOT intended for protection against electrical shock.



Electronics Long-Nose Pliers

Slim Long-Nose Pliers

Additional Features:

- Longer nose and handles for deeper reach into work.
- Spring-loaded for self-opening action.
- Curved handles provide greater tool control.



D307-5 1/2C

Cat. No.	Overall Length	Jaw Length	Jaw Width	Jaw Thickness	Point Thickness	Handle Finish	Handle Color	Weight (lbs.)
Knurled Jaws – Sure-wrapping and looping								
D307-5 1/2C	5-5/8" (143 mm)	1-11/16" (43 mm)	1/2" (13 mm)	5/16" (8 mm)	1/32" (.8 mm)	plastic-dipped	yellow	.15
Smooth Inside Jaws – Radiused jaw edges help prevent nicking wire								
D327-5 1/2C	5-5/8" (143 mm)	1-11/16" (43 mm)	1/2" (13 mm)	5/16" (8 mm)	1/16" (1.6 mm)	plastic-dipped	dark blue	.16

Midget Long-Nose Pliers – Slim-Nose

Additional Features:

- Lightweight, slim-nose pliers for precision subminiature assembly work.
- Knurled jaws for sure wrapping and looping.
- Curved handles provide greater tool control.
- Spring-loaded action for self-opening.



D322-4 1/2C

Cat. No.	Overall Length	Jaw Length	Jaw Width	Jaw Thickness	Point Thickness	Handle Finish	Handle Color	Weight (lbs.)
D321-4 1/2C	4-13/16" (122 mm)	1-1/16" (27 mm)	7/16" (11 mm)	1/4" (6 mm)	1/32 x 1/16" (.8 x 1.6 mm)	plastic-dipped	royal blue	.14
Smooth Inside Jaws – Radiused jaw edges help prevent nicking wire								
D322-4 1/2C	4-13/16" (122 mm)	1-1/16" (27 mm)	7/16" (11 mm)	1/4" (6 mm)	1/32 x 1/16" (.8 x 1.6 mm)	plastic-dipped	royal blue	.14

Midget Flat Long-Nose Pliers

Additional Features:

- Jaw width tapers to narrow flat tip for sure gripping in confined areas.
- Polished inside jaws help prevent nicking wire.
- Spring-loaded for self-opening action.
- Curved handles provide greater tool control.



D323-4 1/2C

Cat. No.	Overall Length	Jaw Length	Jaw Width	Jaw Thickness	Point Thickness	Handle Finish	Handle Color	Weight (lbs.)
D323-4 1/2C	4-13/16" (122 mm)	1-1/16" (27 mm)	7/16" (11 mm)	1/4" (6 mm)	1/8 x 1/16" (3 x 1.6 mm)	plastic-dipped	royal blue	.14

Tapered Long-Nose Pliers

Additional Features:

- Larger and sturdier yet tapered design allows access into tight areas.
- Knurled jaws for sure wrapping and looping.
- Spring-loaded for self-opening action.
- Curved handles provide greater tool control.



D310-6C

Cat. No.	Overall Length	Jaw Length	Jaw Width	Jaw Thickness	Point Thickness	Handle Finish	Handle Color	Weight (lbs.)
D310-6C	6-5/8" (168 mm)	1-7/8" (48 mm)	11/16" (18 mm)	3/8" (10 mm)	1/16" (1.6 mm)	plastic-dipped	yellow	.27

All dimensions are in inches and (millimeters).

▲WARNING: Always wear approved eye protection.

▲WARNING: NOT insulated. Plastic-dipped or slip-on plastic handles are NOT intended for protection against electrical shock.

Electronics Long-Nose Pliers

Long-Nose Pliers – Chain Nose

Additional Features:

- Knurled jaws for sure gripping, bending and forming of medium-gauge wire.
- Spring-loaded for self-opening action.
- Curved handles provide greater tool control.



D317-5C

Cat No.	Overall Length	Jaw Length	Jaw Width	Jaw Thickness	Point Thickness	Handle Finish	Handle Color	Weight (lbs.)
D317-5C	5-1/16" (129 mm)	1-1/8" (29 mm)	1/2" (13 mm)	5/16" (8 mm)	1/16" (1.6 mm)	plastic-dipped	yellow	.14

Needle-Nose Pliers – Side-Cutting

Additional Features:

- Extra length for added reach in confined areas.
- Knurled jaws for sure wrapping and looping.
- Spring-loaded for self-opening action.
- Curved handles provide greater tool control.

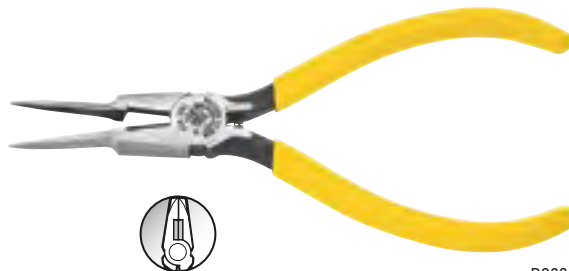

D203-6SCPC

Cat. No.	Overall Length	Jaw Length	Jaw Width	Jaw Thickness	Knife Length	Point Thickness	Handle Finish	Handle Color	Weight (lbs.)
D203-6SCPC	6-5/8" (168 mm)	1-7/8" (48 mm)	11/16" (18 mm)	3/8" (10 mm)	1/2" (13 mm)	1/16" (1.6 mm)	plastic-dipped	yellow	.26

Long Needle-Nose Pliers

Additional Features:

- Designed for accurate work in hard-to-reach areas.
- Knurled jaws for sure wrapping and looping.
- Spring-loaded for self-opening action.
- Curved handles provide greater tool control.



D318-5 1/2C

Cat. No.	Overall Length	Jaw Length	Jaw Width	Jaw Thickness	Point Thickness	Handle Finish	Handle Color	Weight (lbs.)
D318-5 1/2C	5-5/8" (143 mm)	1-11/16" (43 mm)	1/2" (13 mm)	5/16" (8 mm)	1/16" (1.6 mm)	plastic-dipped	yellow	.13

Smooth Inside Jaws – Radiused jaw edges help prevent nicking wire edges

D328-5 1/2C	5-5/8" (143 mm)	1-11/16" (43 mm)	1/2" (13 mm)	5/16" (8 mm)	1/16" (1.6 mm)	plastic-dipped	dark blue	.14
-------------	-----------------	------------------	--------------	--------------	----------------	----------------	-----------	-----

Long Needle-Nose Pliers – Extra-Slim

Additional Features:

- Long, narrow nose and slim hinge for extremely close quarter work.
- Finely knurled jaws grip thin wire without damaging it.
- Spring-loaded for self-opening action.
- Curved handles provide greater tool control.



D335-5 1/2C

Cat. No.	Overall Length	Jaw Length	Jaw Width	Jaw Thickness	Point Thickness	Handle Finish	Handle Color	Weight (lbs.)
D335-5 1/2C	5-5/8" (143 mm)	1-11/16" (43 mm)	15/32" (12 mm)	1/4" (6 mm)	1/16" (1.6 mm)	plastic-dipped	royal blue	.13

All dimensions are in inches and (millimeters).

▲WARNING: Always wear approved eye protection.

▲WARNING: NOT insulated. Plastic-dipped or slip-on plastic handles are NOT intended for protection against electrical shock.



Electronics Long-Nose Pliers

Curved Long-Nose Pliers

Additional Features:

- 70° bent nose for maximum work visibility in confined areas.
- Knurled jaws for sure wrapping and looping.
- Curved handles provide greater tool control.



D302-6

Cat. No.	Overall Length	Jaw Length	Jaw Width	Jaw Thickness	Point Thickness	Handle Finish	Handle Color	Weight (lbs.)
D302-6	6-3/8" (162 mm)	1-1/2" (38 mm)	11/16" (18 mm)	3/8" (10 mm)	3/32" (2 mm)	plastic-dipped	yellow	.30

Midget Curved Chain-Nose Pliers

Additional Features:

- 60° bent nose for maximum work visibility in confined areas.
- Easily bends and forms fine wire.
- Polished inside jaws and radiused jaw edges prevent nicking wire.
- Spring-loaded for self-opening action.
- Curved handles provide greater tool control.



D320-4 1/2C

Cat. No.	Overall Length	Jaw Length	Jaw Width	Jaw Thickness	Point Thickness	Handle Finish	Handle Color	Weight (lbs.)
D320-4 1/2C	4-3/4" (121 mm)	1" (25 mm)	13/32" (10 mm)	1/4" (6 mm)	1/16" (1.6 mm)	plastic-dipped	royal blue	.13

Special Use Long-Nose Pliers

Conduit Locknut and Reaming Pliers

Additional Features:

- Tightens 1/2" and 3/4" EMT or 1/2" rigid locknuts.
- Fits liquid tight fittings and caps.
- Reams and smooths both inside and outside of conduit.
- Knurled jaws at nose tip pull wire or fish tape.
- Machined nose fits snugly into locknut wings.

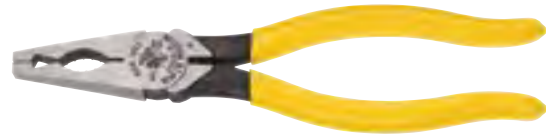

D333-8

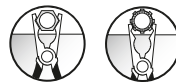

Cat. No.	Overall Length	Jaw Length	Jaw Width	Jaw Thickness	Point Thickness	Handle Finish	Handle Color	Weight (lbs.)
D333-8	7-3/4" (197 mm)	1-5/8" (41 mm)	15/16" (24 mm)	1/2" (13 mm)	3/16" (4.8 mm)	plastic-dipped	yellow	.55

All dimensions are in inches and (millimeters).

▲WARNING: Always wear approved eye protection.

▲WARNING: NOT insulated. Plastic-dipped or slip-on plastic handles are NOT intended for protection against electrical shock.

Special Use Pliers

End-Cutting Pliers

- Wide throat clearance for clean, even cutting of wire or nails at close range.
- High-leverage design provides greater cutting power at the knives than other plier designs.
- Extended handles for longer reach and increased leverage.



D232-8

Cat. No.	Overall Length	Jaw Length	Jaw Width	Jaw Thickness	Knife Length	Handle Finish	Handle Color	Weight (lbs.)
D232-8	8-1/2" (216 mm)	3/8" (10 mm)	1-3/16" (30 mm)	19/32" (15 mm)	1-3/16" (30 mm)	plastic-dipped	red	.71

Plastic Cutting Pliers

- Precisely cuts injection mold sprues, gates and other plastic.
- Adjustable 1/16" hollow-head screw keeps knife-edges from damaging each other (not designed for use on metal).
- Spring-loaded for self-opening action.

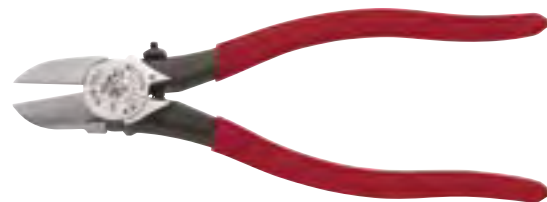

D227-7C

Cat. No.	Overall Length	Jaw Length	Jaw Width	Jaw Thickness	Cutting Knives	Handle Finish	Handle Color	Weight (lbs.)
D227-7C	7-11/16" (195 mm)	1" (25 mm)	31/32" (25 mm)	1/2" (13 mm)	flush	plastic-dipped	red	.55

Slip-Joint Pliers

Slip-Joint Pliers

- Shear-type cutter for precision wire cutting.
- Two versatile jaw positions.
- Serrated jaws provide sure-gripping power.
- Nickel-chrome plated for long life.



D511-6

Cat. No.	Overall Length	Jaw Length	Jaw Width	Jaw Thickness	Handle Finish	Handle Color	Weight (lbs.)
D511-6	6-9/16" (167 mm)	1-3/16" (30 mm)	1-3/16" (30 mm)	3/8" (10 mm)	plastic-dipped	blue	.39
D511-8	8-1/16" (205 mm)	1-3/8" (35 mm)	1-1/4" (32 mm)	7/16" (11 mm)	plastic-dipped	blue	.62
511-10	9-3/4" (248 mm)	1-3/4" (44 mm)	1-3/8" (35 mm)	15/32" (12 mm)	plain	n/a	.81
D511-10	9-7/8" (251 mm)	1-3/4" (44 mm)	1-3/8" (35 mm)	15/32" (12 mm)	plastic-dipped	blue	.83

Slip-Joint Pliers – Hose Clamp

- Quickly installs and removes spring-tension hose clamps.
- Grips with either end or side of jaws for work in confined areas.
- Nickel-chrome plated for long life.



D514-8

Cat. No.	Overall Length	Jaw Length	Jaw Width	Jaw Thickness	Handle Finish	Handle Color	Weight (lbs.)
D514-8	8-1/16" (205 mm)	1-3/8" (35 mm)	1-1/4" (32 mm)	7/16" (11 mm)	plastic-dipped	blue	.61

All dimensions are in inches and (millimeters).

▲WARNING: Always wear approved eye protection.

▲WARNING: NOT insulated. Plastic-dipped or slip-on plastic handles are NOT intended for protection against electrical shock.



Pump Pliers

Klaw™ Pump Pliers

- Push button and quick ratchet feature allows for fast and easy adjustment to any position. (Cat. Nos. D504-10B, D504-12B).
- Compact, narrow design for easy work in small or hard to reach spaces.
- Gripping surfaces with specially hardened teeth for reduced wear and positive gripping.
- Extended grips for added comfort.



D504-10



Quick-Adjust Pump Pliers:

Push button and quick ratchet feature allows for fast and easy adjustment to any position. (Cat. Nos. D504-10B, D504-12B).

Cat. No.	Overall Length	Max. Jaw Capacity	Handle Finish	Handle Color	Weight
Quick-Adjust Klaw™ Pump Pliers					
D504-10B	10-1/8" (257 mm)	2-1/8" (54 mm)	plastic-dipped	yellow	0.79 lbs. (0.36 kg)
D504-12B	12-1/2" (318 mm)	2-3/4" (70 mm)	plastic-dipped	yellow	1.2 lbs. (0.54 kg)
Classic Klaw™ Pump Pliers					
D504-7	7-3/8" (187 mm)	1-3/8" (35 mm)	plastic-dipped	yellow	0.34 lbs. (0.15 kg)
D504-10	9-7/8" (250 mm)	2-1/8" (54 mm)	plastic-dipped	yellow	0.81 lbs. (0.37 kg)
D504-12	12" (305 mm)	2-3/4" (70 mm)	plastic-dipped	yellow	1.4 lbs. (0.64 kg)

Pump Pliers

- Secure tongue and groove design for non-slip grip – even with heavy pressure.
- Wide range of versatile jaw positions.



D502-6

Cat. No.	Overall Length	Max. Jaw Capacity	Handle Finish	Handle Color	Weight (lbs.)
D502-6	6-1/2" (165 mm)	7/8" (22 mm)	plastic-dipped	yellow	.41
D502-10	10" (254 mm)	1-3/4" (45 mm)	plastic-dipped	yellow	.97
D502-12	12-1/4" (311 mm)	2-3/8" (60 mm)	plastic-dipped	yellow	1.37
D502-16	16-3/4" (425 mm)	4-1/4" (108 mm)	plastic-dipped	yellow	3.22
Journeyman™ Series – Dual-material handles					
J502-10	10-1/4" (260 mm)	1-3/4" (45 mm)	Journeyman	yellow/black	1.02

Refer to the insulated section for insulated pliers.

Pipe-Wrench Pliers – Angled Head

- 90° angled jaws provide 20% more leverage than 32° angled jaws.
- Secure tongue and groove design for non-slip grip – even with heavy pressure.
- Seven versatile jaw positions.
- Handle stop design prevents pinched fingers.



D503-10

Cat. No.	Overall Length	Max. Jaw Capacity	Handle Finish	Handle Color	Weight (lbs.)
D503-10	10-1/4" (260 mm)	2-1/8" (54 mm)	plastic-dipped	yellow	1.14
D503-12	13-1/4" (336 mm)	2-5/8" (67 mm)	plastic-dipped	yellow	2.14

All dimensions are in inches and (millimeters).

⚠WARNING: Always wear approved eye protection.

⚠WARNING: NOT insulated. Plastic-dipped or slip-on plastic handles are NOT intended for protection against electrical shock.



Pliers Handles

Replacement Klein-Koat® Pliers Handles

- Plastic material for slip-resistant grip and comfort.

Cat. No.	Size to Fit Pliers	Color	Weight (lbs.)
60	6" (152 mm) long	maroon	.05
70	7" (178 mm) long	maroon	.10
89	8" – 9" (203 mm – 229 mm) long	maroon	.10



70

Replacement Comfort-Grip Pliers Handles

- Klein exclusive slip-reducing pliers handle.
- Aerated plastic construction provides firm and resilient cushion.

Cat. No.	Size to Fit Pliers	Color	Weight (lbs.)
55	5" – 6-1/2" (127 mm – 165 mm) long	red	.05



55



All dimensions are in inches and (millimeters).

▲WARNING: Always wear approved eye protection.

▲WARNING: NOT insulated. Plastic-dipped or slip-on plastic handles are NOT intended for protection against electrical shock.

Journeyman™ Series

The Journeyman™ line of hand tools represents the best of Klein quality and workmanship combined with the latest innovations in handle design.

For Professionals... Since 1857®



Journeyman™ Series

Side-Cutting Pliers

Features:

JOURNEYMAN

State-of-the-art dual material molding process



Color-coded yellow, dark blue, red, or light blue handles allow quick identification of tool.

Soft material on outer surface for comfort and a firm grip.

Contoured thumb area for additional comfort and positive feel.

Hard, black material for toughness and durability.

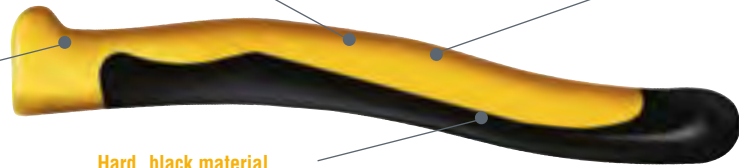

High-Leverage Side-Cutting Pliers

Additional Features:

- High-leverage design. Rivet is closer to the cutting edge for 46% greater cutting and gripping power than other plier designs.
- Streamlined design with sure-gripping, cross-hatched knurled jaws.
- Induction-hardened cutting knives for long life.
- Hot-riveted joint ensures smooth action and no handle wobble.



J2000-9NE

Cat. No.	Nose Type	Overall Length	Jaw Length	Jaw Width	Jaw Thickness	Knife Length	Handle Finish	Handle Color	Weight (lbs.)
J213-8NE	New England	8-13/16" (224 mm)	1-7/16" (37 mm)	1-3/16" (30 mm)	5/8" (16 mm)	23/32" (18 mm)	Journeyman	dark blue/black	.97
J213-9NE	New England	9-1/2" (241 mm)	1-19/32" (41 mm)	1-1/4" (32 mm)	5/8" (16 mm)	25/32" (20 mm)	Journeyman	dark blue/black	1.13

2000 Series* – Heavy-duty cutting knives

J2000-9NE	New England	9-1/2" (241 mm)	1-19/32" (41 mm)	1-1/4" (32 mm)	5/8" (16 mm)	25/32" (20 mm)	Journeyman	light blue/black	1.13
-----------	-------------	-----------------	------------------	----------------	--------------	----------------	------------	------------------	------

*Cuts ACSR, screws, nails, and most hardened wire. Features combination polished and black-oxide finish.

High-Leverage Side-Cutting Pliers – Fish-Tape Pulling

Additional Features:

- Easily pulls 1/8" or 1/4" flat steel fish tape without damaging the tape.
- High-leverage design. Rivet is closer to the cutting edge for 46% greater cutting and gripping power than other plier designs.
- Streamlined design with sure-gripping, cross-hatched knurled jaws.
- Induction-hardened cutting knives for long life.
- Hot-riveted joint ensures smooth action and no handle wobble.



J2000-9NETP

Cat. No.	Nose Type	Overall Length	Jaw Length	Jaw Width	Jaw Thickness	Knife Length	Handle Finish	Handle Color	Weight (lbs.)
J213-9NETP	New England	9-1/2" (241 mm)	1-19/32" (41 mm)	1-1/4" (32 mm)	5/8" (16 mm)	25/32" (20 mm)	Journeyman	dark blue/black	1.11

2000 Series* – Heavy-duty cutting knives

J2000-9NETP	New England	9-1/2" (241 mm)	1-19/32" (41 mm)	1-1/4" (32 mm)	5/8" (16 mm)	25/32" (20 mm)	Journeyman	light blue/black	1.14
-------------	-------------	-----------------	------------------	----------------	--------------	----------------	------------	------------------	------

*Cuts ACSR, screws, nails, and most hardened wire. Features combination polished and black-oxide finish.

High-Leverage Side-Cutting Pliers – Connector Crimping

Additional Features:

- Crimping die behind hinge for superior leverage crimping non-insulated connectors, lugs and terminals.
- High-leverage design. Rivet is closer to the cutting edge for 46% greater cutting and gripping power than other plier designs.
- Streamlined design with sure-gripping, cross-hatched knurled jaws
- Induction-hardened cutting knives for long life.
- Hot-riveted joint ensures smooth action and no handle wobble.



J213-9NECR

Cat. No.	Nose Type	Overall Length	Jaw Length	Jaw Width	Jaw Thickness	Knife Length	Handle Finish	Handle Color	Weight (lbs.)
J213-9NECR	New England	9-1/2" (241 mm)	1-19/32" (41 mm)	1-1/4" (32 mm)	5/8" (16 mm)	25/32" (20 mm)	Journeyman	yellow/black	1.13

2000 Series* – Heavy-duty cutting knives

J2000-9NECR*	New England	9-1/2" (241 mm)	1-19/32" (41 mm)	1-1/4" (32 mm)	5/8" (16 mm)	25/32" (20 mm)	Journeyman	light blue/black	1.12
--------------	-------------	-----------------	------------------	----------------	--------------	----------------	------------	------------------	------

*Cuts ACSR, screws, nails, and most hardened wire. Features combination polished and black-oxide finish.

All dimensions are in inches and (millimeters).

WARNING: Always wear approved eye protection.

WARNING: NOT insulated. Plastic-dipped or slip-on plastic handles are NOT intended for protection against electrical shock.



Side-Cutting Pliers

JOURNEYMAN

High-Leverage Side-Cutting Pliers – Connector Crimping & Fish Tape Pulling

Additional Features:

- Built-in crimper works on non-insulated connectors, lugs, and terminals.
- Built-in channel pulls steel fish tape without damaging the tape.
- 2000 series heavy-duty cutting knives cut ACSR, screws, nails, and most hardened wire.



J2000-9NECRTP

Cat. No.	Nose Type	Overall Length	Jaw Length	Jaw Width	Jaw Thickness	Knife Length	Handle Finish	Handle Color	Weight (lbs.)
J2000-9NECRTP	New England	9-1/2" (241 mm)	1-19/32" (41 mm)	1-1/4" (32 mm)	5/8" (16 mm)	25/32" (20 mm)	Journeyman	light blue/black	1.13

*Cuts ACSR, screws, nails, and most hardened wire. Features combination polished and black-oxide finish.

High-Leverage Universal Combination Pliers

Additional Features:

- Universal tapered head-design allows greater access in confined spaces.
- Precision machined pipe-grip for greater gripping power.
- Crimping die behind hinge for superior leverage crimping of non-insulated connectors, lugs and terminals.



J12098

Cat. No.	Nose Type	Overall Length	Jaw Length	Jaw Width	Jaw Thickness	Knife Length	Handle Finish	Handle Color	Weight (lbs.)
J12098	Universal	8-3/4" (222 mm)	1-25/32" (45 mm)	1-1/32" (26 mm)	17/32" (13 mm)	3/4" (19 mm)	Journeyman	dark blue/black	.82

8" High-Leverage Side-Cutting Pliers

Additional Features:

- High-leverage design. Rivet is closer to the cutting edge for 46% greater cutting and gripping power.
- 2000 series cut screws, nails, and most hardened wire.
- Combination polished and black-oxide finishes.



J2000-8

Cat. No.	Nose Type	Overall Length	Jaw Length	Jaw Width	Jaw Thickness	Knife Length	Handle Finish	Handle Color	Weight (lbs.)
J2000-8	New England Tapered	8-13/16" (224 mm)	1-7/16" (37 mm)	1-7/64" (28 mm)	5/8" (16 mm)	3/4" (19 mm)	Journeyman	light blue/black	.93

7" Side-Cutting Pliers

Additional Features:

- 2000 series cut screws, nails, and most hardened wire.
- Combination polished and black-oxide finishes.



J2001-7NE

Cat. No.	Nose Type	Overall Length	Jaw Length	Jaw Width	Jaw Thickness	Knife Length	Handle Finish	Handle Color	Weight (lbs.)
J2001-7NE	New England	7-9/16" (192 mm)	1-9/32" (33 mm)	1-1/16" (27 mm)	1/2" (13 mm)	5/8" (16 mm)	Journeyman	light blue/black	.61

All dimensions are in inches and (millimeters).

▲WARNING: Always wear approved eye protection.

▲WARNING: NOT insulated. Plastic-dipped or slip-on plastic handles are NOT intended for protection against electrical shock.



Diagonal-Cutting Pliers

JOURNEYMAN

High-Leverage Diagonal-Cutting Pliers

Additional Features:

- High-leverage design. Rivet is closer to the cutting edge for 36% greater cutting and gripping power than other plier designs.
- Short jaws and beveled cutting edges permit close cutting of wire.
- Induction-hardened cutting knives for long life.
- Hot-riveted joint ensures smooth action and no handle wobble.



J2000-28

Cat. No.	Overall Length	Jaw Length	Jaw Width	Jaw Thickness	Cutting Knives	Handle Finish	Handle Color	Weight (lbs.)
J228-8	8-1/8" (206 mm)	13/16" (21 mm)	1-3/16" (30 mm)	7/16" (11 mm)	standard	Journeyman	red/black	.67

2000 Series* – Heavy-duty cutting knives

J2000-28	8-1/8" (206 mm)	13/16" (21 mm)	1-3/16" (30 mm)	7/16" (11 mm)	standard	Journeyman	light blue/black	.67
----------	-----------------	----------------	-----------------	---------------	----------	------------	------------------	-----

*Cuts ACSR, screws, nails, and most hardened wire. Features combination polished and black-oxide finish.

High-Leverage Diagonal-Cutting Pliers – Angled Head

Additional Features:

- Angled head design for easy work in confined spaces.
- High-leverage design. Rivet is closer to the cutting edge for 36% greater cutting and gripping power than other plier designs.
- Short jaws and beveled cutting edges permit close cutting of wire.
- Induction-hardened cutting knives for long life.
- Hot-riveted joint ensures smooth action and no handle wobble.



J2000-48

Cat. No.	Overall Length	Jaw Length	Jaw Width	Jaw Thickness	Cutting Knives	Handle Finish	Handle Color	Weight (lbs.)
J248-8	8-1/8" (206 mm)	13/16" (21 mm)	1-3/16" (30 mm)	7/16" (11 mm)	standard	Journeyman	red/black	.61

2000 Series* – Heavy-duty cutting knives

J2000-48	8-1/8" (206 mm)	13/16" (21 mm)	1-3/16" (30 mm)	7/16" (11 mm)	standard	Journeyman	light blue/black	.61
----------	-----------------	----------------	-----------------	---------------	----------	------------	------------------	-----

*Cuts ACSR, screws, nails, and most hardened wire. Features combination polished and black-oxide finish.

Long-Nose Pliers

All-Purpose Pliers

Additional Features:

- Strips 8-16 AWG Solid and 10-18 AWG Stranded wire.
- Induction-hardened cutting knives for increased wire cutting performance, including hard wire.
- Long nose for grabbing and looping wire.
- 6-32 and 8-32 screw shearing
- Dual material Journeyman™ handles provide better grip.

NEW!

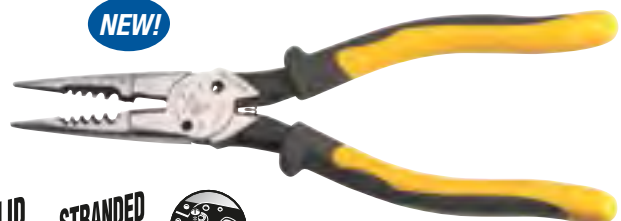

J206-8C



Cat. No.	Overall Length	Jaw Length	Jaw Width	Jaw Thickness	Knife Length	Point Thickness	Handle Finish	Handle Color	Weight (lbs.)
D206-8C	8-5/8" (214 mm)	2-3/16" (59 mm)	1" (25 mm)	1/2" (13 mm)	1/2" (13 mm)	1/8" (3 mm)	Journeyman	yellow/gray	.60

Heavy-Duty Long-Nose Pliers – Side-Cutting

Additional Features:

- Induction-hardened, long-lasting cutting knives.
- Heavier design for greater cutting power.
- Slim head design for working in confined areas.
- Hot-riveted joint ensures smooth action and no handle wobble.



J203-8

Cat. No.	Overall Length	Jaw Length	Jaw Width	Jaw Thickness	Knife Length	Point Thickness	Handle Finish	Handle Color	Weight (lbs.)
J203-8	8-9/16" (218 mm)	2-5/16" (59 mm)	1" (25 mm)	1/2" (13 mm)	5/8" (16 mm)	1/8" (3 mm)	Journeyman	yellow/black	.63

Wire Stripping – Cleanly strips 12 AWG wire

J203-8N	8-9/16" (218 mm)	2-5/16" (59 mm)	1" (25 mm)	1/2" (13 mm)	5/8" (16 mm)	1/8" (3 mm)	Journeyman	yellow/black	.64
---------	------------------	-----------------	------------	--------------	--------------	-------------	------------	--------------	-----

All dimensions are in inches and (millimeters).

⚠WARNING: Always wear approved eye protection.

⚠WARNING: NOT insulated. Plastic-dipped or slip-on plastic handles are NOT intended for protection against electrical shock.

Journeyman™ Series



Long-Nose Pliers

JOURNEYMAN

Standard Long-Nose Pliers

Additional Features:

- Slim head design for working in confined areas.
- Induction-hardened, long-lasting cutting knives.
- Knurled jaws for sure wrapping and looping.
- Hot-riveted joint ensures smooth action and no handle wobble.

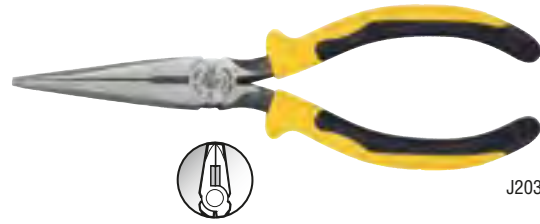

J203-7

Cat. No.	Overall Length	Jaw Length	Jaw Width	Jaw Thickness	Knife Length	Point Thickness	Handle Finish	Handle Color	Weight (lbs.)
J203-6	6-3/4" (171 mm)	1-7/8" (48 mm)	11/16" (18 mm)	3/8" (10 mm)	1/2" (13 mm)	3/32" (2 mm)	Journeyman	yellow/black	.30
J203-7	7-5/16" (186 mm)	2-7/16" (62 mm)	11/16" (18 mm)	3/8" (10 mm)	1/2" (13 mm)	3/32" (2 mm)	Journeyman	yellow/black	.33

Pump Pliers

Pump Pliers

Additional Features:

- Secure tongue and groove design for non-slip grip – even with heavy pressure.
- Wide range of versatile jaw positions.
- Tension-loaded joint to reduce handle wobble for sure gripping.
- Induction-hardened jaws for long life.



J502-10

Cat. No.	Overall Length	Max. Jaw Capacity	Handle Finish	Handle Color	Weight (lbs.)
J502-10	10-1/4" (260 mm)	1-3/4" (45 mm)	Journeyman	yellow/black	1.02

Crimping Tool

Crimping/Cutting Tool – Non-Insulated/Insulated Connectors

Additional Features:

- Designed to crimp insulated and non-insulated 10 to 22 AWG solderless terminals and connectors.
- Tapered nose design for working in confined spaces.
- Contoured thumb area for additional comfort and positive feel.
- Specially hardened cutter.
- Hot-riveted joint ensures smooth action and no handle wobble.



J1005

Cat. No.	Overall Length	Handle Finish	Handle Color	Weight (lbs.)
J1005	9-3/4" (248 mm)	Journeyman	red/black	.84

Cable Cutter

High-Leverage Cable Cutter

Additional Features:

- Cuts up to 4/0 aluminum AWG (no ACSR), 2/0 AWG soft copper and 100-pair 24 AWG communications cable.
- High-leverage for greater cutting power.
- Precision, one-hand shearing action.



J63050

⚠WARNING: Do NOT use to cut steel or ACSR.

Cat. No.	Overall Length	Handle Finish	Handle Color	Weight (lbs.)
J63050	9-9/16" (243 mm)	Journeyman	red/black	.98

All dimensions are in inches and (millimeters).

⚠WARNING: Always wear approved eye protection.

⚠WARNING: NOT insulated. Plastic-dipped or slip-on plastic handles are NOT intended for protection against electrical shock.



Telecom Tools

Telecom workers prefer Klein tools for their exceptional quality, performance, and long working life. That's why Klein is the brand the industry depends on.

F O R P r o f e s s i o n a l s . . . S i n c e 1 8 5 7 ®



Telecom Tools



Telecom Tools

Bell-System Pliers Selection Chart

Bell-System Designation	Cat. No.
Type B Long-Nose	D301-6
List 1 Long-Nose	71980
Type B Short-Nose	D2291
Diagonal B-5	D245-5

Bell-System Designation	Cat. No.
Diagonal B V-Notch	D528V
Diagonal D-6	72192
8" B Sidecut	D213-8NE
9" B Sidecut	D213-9NE

Bell-System Designation	Cat. No.
C Pressing	D234-6
C Pressing	VDV026-049

Diagonal Bell-System Pliers – “W” & “V” Notches

- “W” notches to cleanly slit insulation.
- “V” notch at the hinge for quick insulation crushing.
- Tapered nose for easy working in confined areas and close tip cutting.



D528V

Cat. No.	Overall Length	Jaw Length	Jaw Width	Jaw Thickness	Cutting Knives	Handle Finish	Handle Color	Weight (lbs.)
D528V	5-3/16" (132 mm)	13/16" (21 mm)	9/16" (14 mm)	3/8" (10 mm)	standard	plastic-dipped	red	.20

Diagonal Telephone Work Pliers – Type D-6

- Tapered nose for easy working in confined areas and close tip cutting.
- Convenient .030" and .045" stripping holes.
- “V” stripping notch in jaw for quick insulation slitting.
- Serrated behind the hinge to crush insulation.



72192

Cat. No.	Overall Length	Jaw Length	Jaw Width	Jaw Thickness	Cutting Knives	Handle Finish	Handle Color	Weight (lbs.)
72192	6-1/8" (156 mm)	13/16" (21 mm)	3/4" (19 mm)	7/16" (11 mm)	standard	plastic-dipped	red	.33

Scotchlok® Connector Crimping Pliers

- Crimps and seats UR, UY, and UG connectors.
- Curved handles for greater control.
- Induction-hardened side-cutting knives for long life.



D234-6

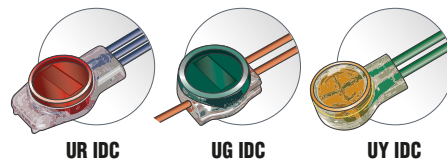

UR IDC

UG IDC

UY IDC

Cat. No.	Overall Length	Jaw Length	Jaw Width	Jaw Thickness	Knife Length	Handle Finish	Handle Color	Weight (lbs.)
D234-6	5-13/16" (148 mm)	1-3/32" (28 mm)	11/16" (18 mm)	3/8" (10 mm)	1/2" (13 mm)	plastic-dipped	yellow	.25
D234-6C*	5-13/16" (148 mm)	1-3/32" (28 mm)	11/16" (18 mm)	3/8" (10 mm)	1/2" (13 mm)	plastic-dipped	yellow	.25

*Spring-loaded action for self-opening. Scotchlok® is a registered trademark of 3M.

All dimensions are in inches and (millimeters).

WARNING: Always wear approved eye protection.

WARNING: NOT insulated. Plastic-dipped or slip-on plastic handles are NOT intended for protection against electrical shock.



Telecom Tools

Connector Crimping Long-Nose Pliers

- Crimps UR/UY/UG insulation displacement connectors (IDC) – Scotchlok® type connectors.
- Grooved jaws for wire wrapping, looping and twisting.
- Cleanly strips 23 AWG and 24 AWG wire.
- Hot-riveted joint ensures smooth action and no handle wobble.
- Induction-hardened cutting knives for long life.
- Yellow plastic grips enhance comfort, visibility and allow quick identification.



VDV026-049

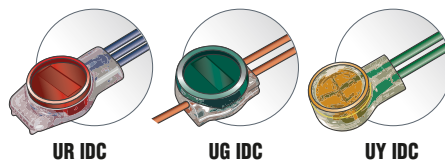

UR IDC

UG IDC

UY IDC

Cat. No	Overall Length	Jaw Length	Jaw Width	Jaw Thickness	Knife Length	Point Thickness	Handle Finish	Handle Color	Weight (lbs.)
VDV026-049	6.8" (173 mm)	2" (51 mm)	0.70" (18 mm)	0.38" (10 mm)	0.44" (11mm)	0.095 x 0.125 (2.0 mm x 3.0 mm)	plastic-dipped	yellow	.28

Scotchlok® is a registered trademark of 3M Corporation.

Long-Nose Telephone Work Pliers – Stripping

- Cleanly strips 22 (.34 mm²) to 24 (.25 mm²) AWG wire.
- Convenient insulation crushing slot.
- Curved handles provide greater tool control.



D2291

Cat. No.	Overall Length	Jaw Length	Jaw Width	Jaw Thickness	Point Thickness	Handle Finish	Handle Color	Weight (lbs.)
D2291	6" (152 mm)	1-1/4" (32 mm)	11/16" (18 mm)	3/8" (10 mm)	1/16" x 3/32" (1.6 mm x 2 mm)	plastic-dipped	yellow	.25

Long-Nose Telephone Work Pliers – Type L1

- Knurled jaw tips for greater gripping power.
- Induction-hardened side-cutting knives for long life.
- Convenient .030" stripping hole.
- Curved handles provide greater tool control.



71980

Cat. No.	Type	Overall Length	Jaw Length	Jaw Width	Jaw Thickness	Knife Length	Point Thickness	Handle Finish	Handle Color	Weight (lbs.)
71980	L1	6-5/8" (168 mm)	1-7/8" (48 mm)	11/16" (18 mm)	3/8" (10 mm)	1/2" (13 mm)	1/16" x 3/32" (1.6 mm x 2 mm)	plastic-dipped	yellow	.25

Standard Long-Nose Pliers – Switchboard Work

- Cleanly strips 19 & 22 AWG wire.
- Induction-hardened, long-lasting cutting knives.
- Knurled jaws for sure wrapping and looping.
- Curved handles provide greater tool control.



D203-6H2

Cat. No.	Overall Length	Jaw Length	Jaw Width	Jaw Thickness	Knife Length	Point Thickness	Handle Finish	Handle Color	Weight (lbs.)
D203-6H2	6-5/8" (168 mm)	1-7/8" (48 mm)	11/16" (18 mm)	3/8" (10 mm)	1/2" (13 mm)	3/32" (2 mm)	plastic-dipped	yellow	.26

All dimensions are in inches and (millimeters).

WARNING: Always wear approved eye protection.

WARNING: NOT insulated. Plastic-dipped or slip-on plastic handles are NOT intended for protection against electrical shock.



Telecom Tools

Can Wrench



68005

- Two tools in one; saves space in your pouch.
- One end opens telephone box fasteners, the other end tightens nuts on binding-post terminals.
- The 7/16" socket has a black finish and the 3/8" socket has a silver finish.
- Sockets are 1-1/4" (32 mm) deep to fit over long binding posts and are thin-walled for easy access into tight areas.
- Socket ends are color-coded for quick identification of socket sizes.
- Hex-socket design enables using a wrench to obtain extra torque.
- High-impact, break-resistant handle for long and dependable service.
- Sockets are heat-treated, alloy steel.

Cat. No.	Description	Length	Handle Diameter	Weight
68005	3/8" and 7/16" hex nut	7" (178 mm)	1" (25 mm)	.35 lbs. (0.16 kg)

⚠WARNING: NOT insulated. Will NOT protect against electrical shock.

Bell System Type Wrench



3146B

- Similar to standard lineman's wrench, but with end openings sized to NEMA hardware specifications.
- Silver painted finish.

Cat. No.	Description	Length	Weight
3146B	Large end has 1-1/16" and 1-3/16" openings. Small end has 11/16" and 7/8" openings.	13" (330 mm)	1.76 lbs. (0.80 kg)

Steel Strand Wire Pulling Grips

Bell System B, L, and H Chicago® Grips – 1628, 1659, 1684 & 1692 Series

- All are equipped with chain, toggle and shackle - keeps the grip from falling off of cable.
- 1659 - 5AT is similar to Bell-System type "B" Strand Puller. Designed to pull 1/4" (6.35 mm) figure-8 telephone cable. Also has serpentine jaw.
- 1684 - 5AT is identical to Bell-System type "L" Strand Puller.
- 1628 - 16AT is identical to Bell-System type "H" Strand Puller.



1659-5AT

Cat. No.	Min. to Max. Cable Diameter inches (mm)	Jaw Length	Approx. Weight Each
5,000 lbs. (2,268 kg) Maximum Safe Load			
1659-5AT ("B" Strand Puller)	.20" - .37" (5.08 mm - 9.40 mm)	5" (127 mm)	6.7 lbs. (3.03 kg)
8,000 lbs. (3,629 kg) Maximum Safe Load			
1684-5AT ("L" Strand Puller)	.218" - .550" (5.54 mm - 13.97 mm)	5" (127 mm)	6.9 lbs (3.13 kg)
1692-5AT ("L" Strand Puller)	.218" - .550" (5.54 mm - 13.97 mm)	5" (127 mm)	6.6 lbs (3.00 kg)
15,000 lbs. (6,803 kg) Maximum Safe Load			
1628-16AT ("H" Strand Puller)	.31" - .62" (7.87 mm - 15.75 mm)	7 1/4" (184 mm)	15.8 lbs (7.16 kg)

*1692-5AT (larger clamping force than 1684-5AT)

⚠WARNING: Grips are to be used for temporary installation, not for permanent anchorage.

⚠WARNING: When used on/or near energized lines, ground, insulate, or isolate grip before pulling.

⚠WARNING: Do not exceed rated capacity.

⚠WARNING: Always match proper size and type of grip to application.

⚠WARNING: Before each use, clean jaw area and inspect grip for proper operation to avoid slippage.



Serpentine Jaw

All dimensions are in inches and (millimeters).

⚠WARNING: Always wear approved eye protection.

⚠WARNING: NOT insulated. Plastic-dipped or slip-on plastic handles are NOT intended for protection against electrical shock.



Voice/Data/Video Tools, Testers & Connectors

Our comprehensive line of verification VDV products were created to **PREP**, **CONNECT** and **TEST** network, phone, CATV, home theater, satellite, and security cables for residential or commercial systems.

F O R P R O F E S S I O N A L S . . . S I N C E 1 8 5 7 ®

Voice/Data/Video Tools
Testers & Connectors



Strippers

Radial Stripper UTP/STP

- One-step outer jacket stripping, 1-level, of category 3, 5, 5e, and 6 cables.
- Durable high-carbon steel cutting blades are ground and honed for long life.
- Removes the outer jacket of twisted pair cable without damaging the conductors.
- Strip and slit lengths may be varied to accommodate different connector requirements.
- Recessed cutting surface slits long runs of twisted-pair cable.
- Multiple nest cavities allow the removal of a wide variety of jacket materials on twisted-pair cable.
- Tension loop can be disengaged for thin-jacket cable.
- One-piece construction ensures alignment for precise stripping.
- Large finger loop promotes rotation during use.
- Adjustable set-screw prevents twisted-pair conductor insulation scoring.



VDV120-006

Cat. No.	Color	Strips or Slits	Level(s)	Strip/Slit Dimensions	Prepared Cable	Overall Length	Weight
VDV120-006	yellow	unshielded twisted pair shielded twisted pair	1	strip length varies by application		4.4" (112 mm)	1.3 oz. (36.9 g)

Coax Combination Radial Stripper – 2-Level

- Two stripping cavities: one for standard size cable and one for utility size cables.
- Cuts five different series of RG cable including: RG6, RG6-QS, RG59, RG11 and RG7.
- 2-level stripping in one step – 5/16" and 1/4" (7.9 mm and 6.4 mm).
- Klein's exclusive sliding depth gauge pre-measures cable for fast, accurate and repeatable strips.
- Durable high-carbon steel cutting blades automatically adjust to different cable diameters.
- Finger loop facilitates easy, controlled rotation.
- Easy debris clean-out.
- Perfect for the data installer who works with utility cable as well standard cable.



VDV110-095

Cat. No.	Color	Levels	Strip Dimensions	Prepared Cable	Overall Length	Weight (oz)
VDV110-095	yellow/gray	2	5/16" and 1/4" (7.9 mm and 6.4 mm)		5.25" (133 mm)	1.5 oz. (42.5 g)

Coax Cable Radial Stripper – 2-Level

- 2-level stripping in one step – 5/16" and 1/4" (7.9 mm and 6.4 mm).
- Klein's exclusive sliding depth gauge pre-measures cable for fast, accurate and repeatable strips.
- Durable high-carbon steel cutting blades automatically adjust to different cable diameters.
- Finger loop facilitates easy, controlled rotation.



VDV110-061

Cat. No.	Color	Levels	Strip Dimensions	Prepared Cable	Overall Length	Weight (oz)
VDV110-061	yellow/black	2	5/16" and 1/4" (7.9 mm and 6.4 mm)		4.6" (116 mm)	1.2 oz. (34.0 g)

All dimensions are in inches and (millimeters).

⚠WARNING: Read carefully and understand instructions before using this tool.

⚠WARNING: Always wear approved eye protection.

⚠WARNING: NOT insulated. Will NOT protect against electrical shock.

⚠WARNING: Never use on or near live electrical circuits.



Radial Strippers and Cartridges

Radial Cartridge Strippers

- Designed for high-volume, multiple-type cable preparation environments.
- Includes storage cartridge-bay.
- One-piece construction ensures precise stripping and never requires adjustment.
- Large finger loop promotes rotation during use.
- Cartridges snap in from both sides for left or right-handed operation.
- F-Connector "nest" assists with cable insertion.
- Durable high-carbon steel cartridge cutting blades are ground and honed for long life.
- Replacement cartridges available.

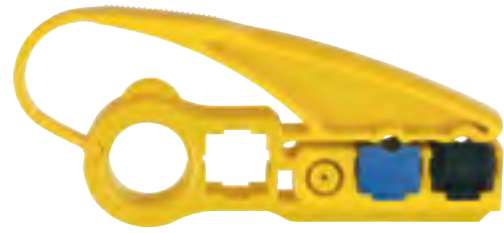

VDV100-801



VDV110-802

Cat. No.	Set Contains	Overall Length	Weight																								
VDV100-801		5.6" (143 mm)	2.4 oz. (68.0 g)																								
	<table border="1"> <thead> <tr> <th>Cat. No.</th> <th>Description</th> <th>Color</th> <th>Level(s)</th> <th>Strip Dimensions</th> <th>Prepared Cable</th> </tr> </thead> <tbody> <tr> <td>VDV100-001</td> <td>dual cartridge radial stripper frame</td> <td>yellow</td> <td>-</td> <td>-</td> <td>-</td> </tr> <tr> <td>VDV110-003</td> <td>RG59/RG6/RG6-QS coaxial cable</td> <td>black</td> <td>2</td> <td>5/16" and 1/4" (7.9 mm and 6.4 mm)</td> <td></td> </tr> <tr> <td>VDV120-005</td> <td>UTP cable</td> <td>blue</td> <td>1</td> <td>variable</td> <td></td> </tr> </tbody> </table>	Cat. No.	Description	Color	Level(s)	Strip Dimensions	Prepared Cable	VDV100-001	dual cartridge radial stripper frame	yellow	-	-	-	VDV110-003	RG59/RG6/RG6-QS coaxial cable	black	2	5/16" and 1/4" (7.9 mm and 6.4 mm)		VDV120-005	UTP cable	blue	1	variable			
Cat. No.	Description	Color	Level(s)	Strip Dimensions	Prepared Cable																						
VDV100-001	dual cartridge radial stripper frame	yellow	-	-	-																						
VDV110-003	RG59/RG6/RG6-QS coaxial cable	black	2	5/16" and 1/4" (7.9 mm and 6.4 mm)																							
VDV120-005	UTP cable	blue	1	variable																							
VDV110-802		5.2" (133 mm)	2.1 oz. (59.5 g)																								
	<table border="1"> <tbody> <tr> <td>VDV100-002</td> <td>radial cartridge stripper frame</td> <td>yellow</td> <td>-</td> <td>-</td> <td>-</td> </tr> <tr> <td>VDV110-003</td> <td>RG59/RG6/RG6-QS coaxial cable</td> <td>black</td> <td>2</td> <td>5/16" and 1/4" (7.9 mm and 6.4 mm)</td> <td></td> </tr> </tbody> </table>	VDV100-002	radial cartridge stripper frame	yellow	-	-	-	VDV110-003	RG59/RG6/RG6-QS coaxial cable	black	2	5/16" and 1/4" (7.9 mm and 6.4 mm)															
VDV100-002	radial cartridge stripper frame	yellow	-	-	-																						
VDV110-003	RG59/RG6/RG6-QS coaxial cable	black	2	5/16" and 1/4" (7.9 mm and 6.4 mm)																							

Radial Stripper Cartridges

Designed for use with:

- Dual Cartridge Radial Stripper (Cat. No. VDV100-801)
- Dual Cartridge Radial Stripper Frame (Cat. No. VDV100-001)
- Radial Cartridge Stripper (Cat. Nos. VDV110-802 & VDV113-804)
- Radial Cartridge Stripper Frame (Cat. No. VDV100-002)

- Pre-set cutting blades for precise, accurate and efficient cable stripping.
- Durable high-carbon steel cutting blades are ground and honed for long life.
- Patented "V" notch eliminates scoring of the center conductor.*
- Color coded for easy identification.
- Meets industry standards established by the SCTE (Society of Cable Telecommunication Engineers).
- Cartridges made from glass filled polycarbonate for superior strength and extended durability.

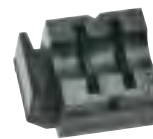

VDV110-003



VDV110-004



VDV110-020



VDV113-022



VDV113-021

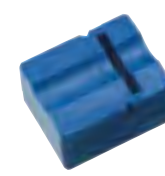

VDV120-005

*All cartridges except for VDV120-005.

Cat No.	Cable	Color	Level	Cartridge Strip Dimensions	Cable Illustration	Weight
VDV110-003	RG59/RG6/RG6 QS coaxial cable	black	2	5/16" x 1/4" (7.9 mm x 6.4 mm)		0.1 oz. (2.8 g)
VDV110-004	RG7/RG11 coaxial cable	gray	2	5/16" x 1/4" (7.9 mm x 6.4 mm)		0.1 oz. (2.8 g)
VDV120-005	UTP cable (category 3, 5, 5e and 6)	blue	1	variable		0.1 oz. (2.8 g)
VDV110-020	mini-coaxial cable	green	2	1/4" x 1/4" (6.4 mm x 6.4 mm)		0.1 oz. (2.8 g)
VDV113-021	RG58/RG59/RG62 coaxial cable	green	3	0.235" x 0.235" x variable (6 mm x 6 mm x variable)		0.1 oz. (2.8 g)
VDV113-022	RG58/RG59/RG62 coaxial cable	brown	3	0.109" x 0.312" x variable (2.8 mm x 7.9 mm x variable)		0.1 oz. (2.8 g)

All dimensions are in inches and (millimeters).

⚠ WARNING: Read carefully and understand instructions before using this tool.

⚠ WARNING: Always wear approved eye protection.

⚠ WARNING: NOT insulated. Will NOT protect against electrical shock.

⚠ WARNING: Never use on or near live electrical circuits.

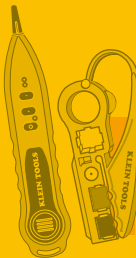

Coax Cable Tools

Coaxial Cable Cutter – CCS

- Multi-functional blade for cutting copper-clad steel (CCS) coaxial cables and cutting and trimming data cables and other general cable/wire.
- Notched blade section optimized to cut common CCS coaxial cables such as RG-59, RG-6/6Q and RG-11.
- Shears blade section designed to cut and snip solid and stranded copper, aluminum, UTP/STP twisted pair wires and cables.
- Blade geometry ensures CCS coaxial cable retains shape when cut to facilitate easy insertion into connectors and excellent terminations.
- High-leverage design for genuine one-handed operation.
- Forged from custom, US-made steel and through-hardened to withstand steel cable cutting.



VDV600-096

Cat. No.	Overall Length	Cutting Knives	Cuts	Handle	Handle Color	Weight
VDV600-096	7-5/8" (194 mm)	Custom notch for CCS coaxial cable Standard shears for general purpose	RG59 RG6 RG6Q RG11	plastic-dipped	yellow	.60 lbs. (272 g)

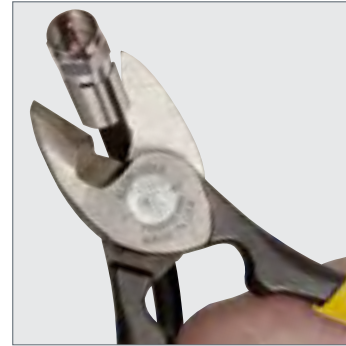

Cushion-Grip F-Connector Insertion/Extraction Tool

- 5" long shaft with 7/16" socket extends reach for connecting/removing F-connectors.
- 3/8"-32 threaded end holds standard F-Connectors for cable insertion.
- Cushion-Grip handle for greater torque and enhanced comfort.
- Precision machined high-carbon steel is hardened for long life.
- Durable chrome finish resists corrosion and extends tool life.



VDV312-012

Cat. No.	Color	Shank Tip	Handle Tip	Shank Length	Finish	Overall Length	Weight
VDV312-012	yellow/black	7/16" open socket	3/8"-32 threaded male F-connector	5" (127 mm)	chrome-plated	8.8" (222 mm)	7.5 oz. (212.6 g)

All dimensions are in inches and (millimeters).

▲WARNING: Read carefully and understand instructions before using this tool.

▲WARNING: NOT insulated. Will NOT protect against electrical shock.

▲WARNING: Always wear approved eye protection.

▲WARNING: Never use on or near live electrical circuits.

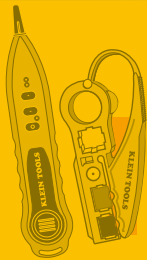

Coax Connector Crimp Tools

Compression Crimper – Lateral, Multi Connector

- One tool crimps most connectors to most coaxial cables – Minicoax, RG58, RG59, RG62, RG6, RG6QS, RG7, and RG11.
- Unique cable selection wheel eliminates the need to change plunger tips, saving time and not losing parts.
- Heavy-duty zinc die-cast chassis for durable, long lasting performance.
- Open design with 180° capture mechanism provides easy insertion, complete compression and simple removal.
- F/BNC/RCA connector markings for quick adjustments.
- Integrated handle lock for easy storage.
- Spring loaded return increases user comfort and ease of use.
- Yellow and black contoured grips enhance comfort, visibility and allow quick identification.



VDV211-063



Connector markings for quick adjustments.

Cat. No	Color	Type	Cable	Connectors	Overall Length	Weight
VDV211-063	yellow/black	compression crimper	coaxial	BNC F RCA	6.25" (158 mm)	18.5 oz. (524.5 g)

Compression Crimper – Compact, Multi-Connector

- Fast, reliable multiple-type compression connector installations.
- Crimps compression BNC, F and RCA connectors to coaxial cable.
- Adjustable universal plunger ensures accurate crimps on multiple types of connectors.
- Open design with 180° capture mechanism provides easy insertion, complete compression and simple removal of cable and connector.
- F/BNC/RCA connector markings for quick adjustments.
- Compact tool with integrated handle lock for easy storage.
- Spring loaded return increases user comfort and ease of use.
- Yellow contoured grips enhance comfort, visibility and allow quick identification.
- Steel body with chrome finish resists corrosion and extends tool life.



VDV211-048



Connector markings for quick adjustments.

Cat. No	Color	Type	Cable	Connectors	Overall Length	Weight
VDV211-048	yellow/chrome	compression crimper	coaxial	BNC, F, RCA	5.6" (142 mm)	8.0 oz. (226.8 g)

Compact, F-Connector

- Fast, reliable F-Connector installation tool.
- Steel body with black-oxide finish for corrosion resistance and durability.
- Fixed plunger allows quick, easy insertion and removal of cable and connector.
- Fixed plunger accepts many common F-connector compression fittings.
- Compact tool with integrated handle lock.
- Yellow and black grips enhance comfort, visibility and allow quick identification.
- Spring loaded return increases user comfort and ease of use.



VDV212-008

Cat. No.	Color	Type	Cable	Connectors	Overall Length	Weight
VDV212-008	yellow/black	compression crimper	coaxial	common F connectors	5.6" (142 mm)	9.8 oz. (277.8 g)

All dimensions are in inches and (millimeters).

⚠WARNING: Read carefully and understand instructions before using this tool.

⚠WARNING: Always wear approved eye protection.

⚠WARNING: NOT insulated. Will NOT protect against electrical shock.

⚠WARNING: Never use on or near live electrical circuits.



Twisted Pair Crimp/Strip Tools

Compact Ratcheting Modular Crimper

- All-inclusive tool cuts, strips and crimps voice and data cables.
- Cuts and strips CAT6, CAT5e, CAT3 and flat-satin voice cables.
- Crimps 6 and 8 position modular connectors.
- Heavy-duty ratchet ensures complete termination.
- Direct lateral crimp action provides more even, precise contact termination across all pins than ordinary indirect crimp tools.
- Compact, ergonomic design for easy usage and storage.
- 40% smaller than many other crimpers.
- Quick reference connector wiring diagrams provided on the tool and downloadable to your mobile device.



VDV226-107

Cat. No.	Color	Cuts & Strips	Crimps Connectors	Position/Pair/ Conductors	Overall Length	Weight
VDV226-107	yellow/black	round STP/UTP data cable flat-satin phone cable 28-22 AWG (0.08 – 0.34 mm ²)	RJ11, RJ12 and RJ45	6-position, 2-pair/4-conductor 6-position, 3-pair/6-conductor 8-position, 4-pair/8-conductor	5.25" (133 mm)	11.2 oz. (318 g)

Ratcheting Modular Crimper/Stripper

- Fast, reliable modular-crimp connector installation for voice and data applications.
- All-In-One Tool, cuts, strips and crimps paired-conductor cables (round STP/UTP and flat-satin phone cable).
- Crimps 4, 6, and 8 position modular connectors (RJ22, RJ11/RJ12 and RJ45).
- Crimping dies are precision ground from high-carbon steel.
- Designed for Western Electric (WE)/Stewart Stamping (SS)-type modular connectors.
- Ratchet safety-release and a blade-guard on cutting and stripping knives reduce risk of injury.
- Full-cycle ratchet mechanism prevents the release of the connector prior to full compression.
- Yellow and black grips enhance comfort, visibility, and allow quick identification.
- Not for use with AMP® connectors.
- Replacement blade set available (Cat. No. VDV999-064).



VDV226-011

AMP® is a registered trademark of TYCO, Inc.

Cat. No.	Color	Cuts & Strips	Crimps Connectors	Position/Pair/ Conductors	Overall Length	Weight
VDV226-011	yellow/black	round STP/UTP, flat satin phone cable 22-28 AWG (0.08 - 0.34 mm ²)	RJ11, RJ12 RJ22 and RJ45	4-position, 1-pair/2-conductor 4-position, 2-pair/4-conductor 6-position, 2-pair/4-conductor 6-position, 3-pair/6-conductor 8-position, 4-pair/8-conductor	7.5" (191 mm)	11.3 oz. (320.3 g)

Connector Crimping Long-Nose Pliers

- Crimps UR/UY/UG insulation displacement connectors (IDC) – Scotchlok® type connectors.
- Grooved jaws for wire wrapping, looping and twisting.
- Cleanly strips 23 AWG and 24 AWG wire.
- Hot-riveted joint ensures smooth action and no handle wobble.
- Induction hardened cutting knives for long life.
- Yellow plastic grips enhance comfort, visibility and allow quick identification.



VDV026-049

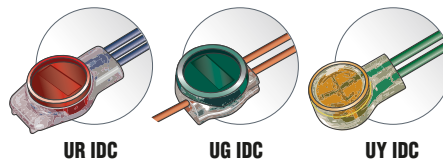

Scotchlok® is a registered trademark of 3M Corporation.

Cat. No	Overall Length	Jaw Length	Jaw Width	Jaw Thickness	Knife Length	Point Thickness	Handle Finish	Handle Color	Weight
VDV026-049	6.80" (173 mm)	2" (51 mm)	0.70" (18 mm)	0.38" (10 mm)	0.44" (11 mm)	0.095 x 0.125 (2.0 mm x 3.0 mm)	plastic-dipped	yellow	4.5 oz. (127.6 g)

All dimensions are in inches and (millimeters).

⚠ WARNING: Read carefully and understand instructions before using this tool.

⚠ WARNING: NOT insulated. Will NOT protect against electrical shock.

⚠ WARNING: Always wear approved eye protection.

⚠ WARNING: Never use on or near live electrical circuits.



Punchdown Tools & Accessories

Punchdown Screwdriver Multi-Tool

- Terminate and cut wire in one step with included 110/66 combination cut-type punchdown blade with precision ground cutting edge.
- Non-impact wire termination.
- Machine-tooled steel bits for superior strength.
- Heavy-duty blade barrel provides storage for bits.
- Bayonet-style (twist & lock) socket accepts most manufacturers' punchdown blades.
- Cushion-Grip handle for greater torque and enhanced comfort.
- Tip-Ident® for quick identification of tool.
- Two Phillips screwdriver tips: #1 and #2.
- Two slotted screwdriver tips: 3/16" and 1/4".
- Two nut drivers: 1/4" and 3/8".
- One hex key: 3/8".
- 6 pc. counter display available (Cat. No. VDV001-0816).



VDV001-081



Cat. No.	Color	Included Bits	Finish	Overall Length	Weight
VDV001-081	yellow/black	#1 & #2 Phillips, 3/16" & 1/4" Slotted, 66/110 Terminate & Cut 1/4" & 3/8" Nut Driver, 3/8" Hex-Key	chrome	8" (203 mm)	9.4 oz. (266.5 g)

Cushion-Grip Impact Punchdown Tools – 110/66

NEW!

- Extra-long punch collar to reach into crowded blocks.
- Cushion-Grip handle for superior comfort.
- Hi / Lo impact settings for use on both 110 and 66 blocks as well as jacks.
- Dura-Blade™ 110/66 Cut Combination Punchdown Blade is designed for durability and performance.
- Professional pick/probe/spudger for precise maintenance of wires on blocks or jacks.
- Multi-pocket pouch with belt clip and reinforced bottom to prevent punctures.



VDV427-822



VDV327-103

VDV427-821

Cat. No.	Description	Overall Length	Weight
VDV427-822	cushion-grip impact punchdown tool kit – 110/66	9.125" (232 mm)	14.9 oz. (422 g)
Kit Contains		End 1 Configuration	End 2 Configuration
VDV427-821*	cushion-grip impact punchdown tool with Dura-Blade™	110 terminate & cut	66 terminate & cut
VDV327-103*	wire pick	hook	spudger
kit exclusive	multi-pocket pouch with reinforced puncture-resistant bottom	-	-

*Items also sold separately

Replacement Blade

Cat. No.	Description	End 1 Configuration	End 2 Configuration	Overall Length	Weight
VDV427-104	Dura-Blade™ 110/66 cut combination punchdown blade	110 terminate & cut	66 terminate & cut	2.25" (57 mm)	.05 oz. (14 g)

All dimensions are in inches and (millimeters).

⚠WARNING: Read carefully and understand instructions before using this tool.

⚠WARNING: Always wear approved eye protection.

⚠WARNING: Do NOT use to pry or chisel.

⚠WARNING: NOT insulated. Will NOT protect against electrical shock.

⚠WARNING: Never use on or near live electrical circuits.

Voice/Data/Video Tools
Testers & Connectors



Punchdown Tools & Accessories

Punchdown Multi-Tool with 1110/66 Blade

- Patent pending locking impact mechanism allows non-impact operation and sure driving with a variety of optional WorkEnds™ driver bits.
- Terminate and cut wire in one step with included precision ground combination 66 & 110 blade.
- Integrated Hook and Spudger for fast, easy manipulation of wire and small components.
- Selectable (Hi/Low) impact-force settings meet industry standards.
- Spring loaded for fast, low effort seating and terminating.
- Dual material contoured chassis provides greater control and enhances comfort.
- Blade storage compartment with spring loaded locking mechanism.
- Color coded yellow on the cut side of the tool.
- Hook and Spudger neatly and compactly store in the chassis, out of the way when not in use.
- Induction hardened high-carbon steel for durability and long life.
- Cat. No. VDV427-807 Includes WorkEnds™ Kit with WorkEnds™ adapter, reach extension, and 4 driver bits (#1 and #2 Phillips and 3/16" and 1/4" Slotted) in a convenient carrier.
- Replacement blades/accessories available.



VDV427-806



Cat. No.	Set Contains	Overall Length	Weight	
VDV427-806	punchdown multi-tool with 110/66 blade	7.0" (176 mm)	5.6 oz. (159 g)	
Cat. No.	Color	Description	Blade Configuration End 1	Blade Configuration End 2
VDV427-047	yellow/red/black	punchdown multi-tool chassis	-	-
VDV427-017	black	punchdown tool blade - combination 66/110 cut type	110 terminate & cut	66 terminate & cut
VDV427-807	punchdown multi-tool with 110/66 blade & WorkEnds™	7.88" (200 mm)	7.5 oz. (213 g)	
Cat. No.	Color	Description	Blade Configuration End 1	Blade Configuration End 2
VDV427-047	yellow/red/black	punchdown multi-tool chassis	-	-
VDV427-017	black	punchdown tool blade - combination 66/110 cut type	110 terminate & cut	66 terminate & cut
VDV770-050	-	WorkEnds™ kit	-	-

Impact Punchdown Tools

- Terminate cable in variety of cross-connect panels, blocks and keystone jacks.
- Spring loaded for fast, low effort seating and terminating.
- Selectable (Hi/Low) impact-force settings meet industry standards.
- Rubber finger grips and boot provide greater control and enhanced comfort.
- Blade storage compartment with spring loaded locking mechanism.
- Bayonet style (twist & lock) socket accepts most manufacturers' tools and blades.
- Induction-hardened high-carbon steel for durability and long life.
- Replacement blades available.



VDV427-800



Cat. No.	Set Contains:	Overall Length	Weight	
VDV427-800	Impact Punchdown Tool - Combination 66/110 Cut Type	7.0" (177 mm)	5.7 oz. (162 g)	
Cat. No.	Color	Description	Blade Configuration End 1	Blade Configuration End 2
VDV427-013	yellow/black	impact punchdown tool	-	-
VDV427-017	black	punchdown tool blade - combination 66/110 cut type	66 terminate & cut	110 terminate & cut
VDV427-805	Impact Punchdown Tool - 110 Type	7.1" (180 mm)	5.6 oz. (159 g)	
Cat. No.	Color	Description	Blade Configuration End 1	Blade Configuration End 2
VDV427-013	yellow/black	impact punchdown tool	-	-
VDV427-015	black	punchdown tool blade - 110 type	110 terminate	110 terminate & cut

All dimensions are in inches and (millimeters).

⚠WARNING: Read carefully and understand instructions before using this tool.

⚠WARNING: NOT insulated. Will NOT protect against electrical shock.

⚠WARNING: Always wear approved eye protection.

⚠WARNING: Never use on or near live electrical circuits.



Punchdown Tools & Accessories

Dura-Blade™ 110/66 Cut Combination Punchdown Blade

- Dura-Blade™ manufactured using Metal Injection Molding (MIM) technology for increased quality, durability and performance.
- Precise cutting-edge for clean, accurate wire insertion and trimming.
- Dual 110 and 66 cutting ends for versatility.
- Compatible with Klein® punchdown tools and other bayonet style (twist & lock) socket punchdown tools.



VDV427-104

Cat. No.	Color	Description	End 1 Configuration	End 2 Configuration	Overall Length	Weight
VDV427-104	chrome	Dura-Blade™ 110/66 Cut Combination Punchdown Blade	66 terminate & cut	110 terminate & cut	2.25" (57 mm)	.5 oz. (14 g)

Punchdown Tool Blades & Accessories

- Compatible with Klein® punchdown tools and other bayonet style (twist & lock) socket punchdown tools.
- Precision ground cutting-edge for clean, precise wire termination (depending on blade type).
- Terminate, and adjust cable in variety of cross-connect panels, blocks and keystone jacks.
- Induction-hardened high-carbon steel blades for durability and long life.
- Reversible blades with termination/cutting ends and termination only ends (depending on blade type).
- WorkEnds™ Kit converts the Punchdown Multi-Tool chassis (VDV427-047) into a multi-bit driver.
- Professional pick/probe/spudger for precise maintenance of wires on blocks or jacks.



VDV427-015



VDV427-016



VDV427-017



VDV770-050†



VDV327-103

Cat. No.	Color	Description	End 1 Configuration	End 2 Configuration	Overall Length	Weight
VDV327-103	yellow	wire pick	hook	spudger	7.25" (184 mm)	.1 oz. (3 g)
VDV427-015	black	high-carbon steel punchdown tool blade - 110 type	110 terminate	110 terminate & cut	2.1" (52 mm)	0.5 oz. (14 g)
VDV427-016	black	high-carbon steel punchdown tool blade - 66 type	66 terminate	66 terminate & cut	2.3" (58 mm)	0.6 oz. (17 g)
VDV427-017	black	punchdown tool blade - combination 66/110 cut type	66 terminate & cut	110 terminate & cut	2.2" (56 mm)	0.6 oz. (17 g)
VDV770-050	-	WorkEnds™ adapter, reach extension, and 4 driver bits (#1 and #2 Phillips and 3/16" and 1/4" Slotted) in a convenient carrier†	proprietary magnetic hex	1/4" female hex	3.2" (81 mm)	1.4 oz. (40 g)

†WorkEnds™ is not compatible with VDV427-013, VDV427-800, VDV427-805.

All dimensions are in inches and (millimeters).

⚠WARNING: Read carefully and understand instructions before using this tool.

⚠WARNING: Always wear approved eye protection.

⚠WARNING: NOT insulated. Will NOT protect against electrical shock.

⚠WARNING: Never use on or near live electrical circuits.



Crimp Tool and Die Sets

Ratcheting Crimper Frame



VDV200-010

- Professional CATV, Electrical, Home Theater, Satellite and Security System ratcheting crimper frame with optional dies is perfect for fast, reliable connector installations.
- Full-cycle ratchet action assures a complete, precise crimp every cycle.
- Preset tension for optimum performance.
- Ratchet mechanism is designed to prevent the release of the connector prior to full compression.
- Safety crimp release helps eliminate rejected terminations due to incorrect positioning.
- Steel body with black-oxide finish for corrosion resistance and durability.
- Yellow and black grips enhance comfort, visibility, and allow quick identification.
- Thumb-screws secure die-sets for quick, easy changes.
- Optional, quick interchangeable die sets thumb and Phillips screw set available (see table).

Cat. No.	Overall Length	Weight
VDV200-010	8.75" (222 mm)	19.0 oz. (539 g)

Coaxial Hex-Crimp Die Sets

Cat. No	Die Set:	Nest Dimensions:	
VDV999-033	Replacement Screw Set (Thumb and Phillips)	N/A	
VDV212-034	CATV F Connectors RG59/6	0.255"/0.320"/0.350" 6.48/8.13/8.89 mm	
VDV205-035	Insulated Terminals, AWG 10-22	AWG 22-18/16-14/12-10 DIN 0.5-1.0/1.5-2.5/4-6 mm ²	
VDV205-036	Non-Insulated Terminal or Open Barrel Terminal, AWG 10-20	AWG 20-18/16-14/12-10 DIN 0.5-1/1.5-2.5/4-6 mm ²	
VDV211-037	RG6/58/59/62	0.256"/0.319"/0.068"/0.213" 6.50/8.10/1.73/5.41 mm	
VDV211-038	RG58/59/62	0.256"/0.068"/0.213" 6.50/1.73/5.41 mm	
VDV205-039	Pin Terminal Insulated or Non-Insulated Ferrules, AWG 12-22	AWG 22/20/18/16/14/12 DIN 0.5/0.75/1.0/ 1.5/2.5/4 mm ²	
VDV201-040	RG58/59/62/174 Fiber Optic	0.043"/0.068"/0.100"/ 0.137"/0.213"/0.255" 1.09/1.73/2.54/3.48/ 5.41/6.48 mm	
VDV211-041	RG58/59/62/6	0.255"/0.213"/0.098"/ 0.068"/0.321" 6.48/5.41/2.49/ 1.73/8.15 mm	
VDV201-042	RG174/179/Belden 8218 and Fiber Optic	0.042"/0.068"/0.078"/ 0.128"/0.151"/0.178" 1.07/7.73/1.98/3.25/ 3.84/4.52 mm	
VDV211-043	RG8/11/174/179/213	0.100"/0.128"/0.429" 2.54/3.25/10.90 mm	
VDV205-044	Non-Insulated Terminal, AWG 8-18	AWG 18-16/14/12-10/8 DIN 0.75-1.5/2.5/4- 6/10 mm ²	

All dimensions are in inches and (millimeters).

▲WARNING: Read carefully and understand instructions before using this tool.

▲WARNING: Always wear approved eye protection.

▲WARNING: NOT insulated. Will NOT protect against electrical shock.

▲WARNING: Never use on or near live electrical circuits.

▲WARNING: Use caution when tightening thumb-screws to prevent thread damage/stripping and hand tighten only; do not over-tighten the thumb screws. Over-tightening thumb-screws can damage the tool and/or die set.



Coax Cable Connectors

Klein Tools' Universal Compression Connector

Installs up to 5X faster!

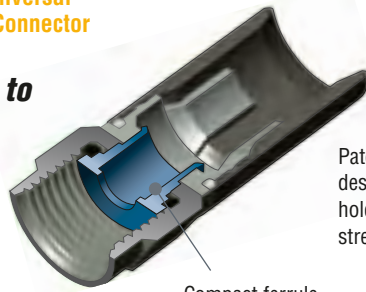

Compact ferrule

Patented universal sleeve design provides excellent holding power and signal strength.

Standard Compression Connector

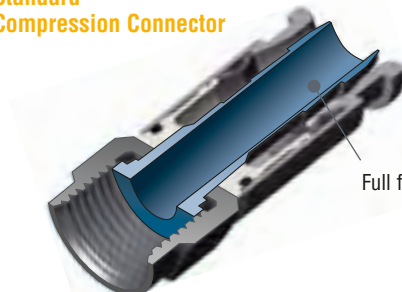

Full ferrule

Connector Type	Universal						Standard
	F-Connector	BNC-Connector	RCA-Connector				F-Connector
Crimping Type	Compression	Compression	Compression				Compression
Cable Type:							
RG59	•	•	•	•	•	•	
RG6		•	•	•	•	•	•
RG6 QUAD SHIELD		•	•	•	•	•	
Universal Sleeve	•	•	•	•	•	•	
Outdoor Use							•
Cat. Nos:							
Pack Size: 10	VDV812-615	VDV812-606	VDV813-616	VDV813-607	VDV813-617	VDV813-608	VDV812-623
Pack Size: 35			VDV813-619	VDV813-613	VDV813-620	VDV813-614	
Pack Size: 50	VDV812-618	VDV812-612					VDV812-624
Klein Crimping Tools	VDV211-063, VDV211-048, VDV211-007						VDV211-063, VDV211-048, VDV211-007, VDV212-008

Universal Compression Connectors

- Fit all manufacturers' diameter variations within a cable series.
- Fit difficult to work with multi-shield and plenum cables.
- For indoor use only.

Cat. No.	Connector Type	Cable Type	Pack Qty.
VDV812-615	F-Connector	RG59	10
VDV812-618	F-Connector	RG59	50
VDV812-606	F-Connector	RG6 - RG6Q	10
VDV812-612	F-Connector	RG6 - RG6Q	50
VDV813-616	BNC Connector	RG59	10
VDV813-619	BNC Connector	RG59	35
VDV813-607	BNC Connector	RG6 - RG6Q	10
VDV813-613	BNC Connector	RG6 - RG6Q	35
VDV813-617	RCA Connector	RG59	10
VDV813-620	RCA Connector	RG59	35
VDV813-608	RCA Connector	RG6 - RG6Q	10
VDV813-614	RCA Connector	RG6 - RG6Q	35

F • RG6-RG6Q



VDV812-606

BNC • RG6-RG6Q



VDV813-607

RCA • RG6-RG6Q



VDV813-608

F • RG59



VDV812-615

BNC • RG59



VDV813-616

RCA • RG59



VDV813-617

Standard Compression Connectors

- Full ferrule design.
- Solid brass construction with nickel-plated finish.
- Best choice for outdoors.
- Great for satellite dishes.



VDV812-623

Push-On Connectors

- Patented, tool-less, easy grip design.
- Fits most major brands.
- For indoor use only.



VDV812-626

Cat. No.	Connector Type	Crimping Type	Cable Type	Pack Qty.
VDV812-623	F-Connector	Compression	RG6	10
VDV812-624	F-Connector	Compression	RG6	50

Cat. No.	Connector Type	Crimping Type	Cable Type	Pack Qty.
VDV812-625	F-Connector	Push-On	RG59	4
VDV812-626	F-Connector	Push-On	RG6 - RG6Q	4
VDV812-627	F-Connector	Push-On	RG6 - RG6Q	10

Voice/Data/Video Tools
Testers & Connectors



Adapters/Terminator

F to BNC Adapter

- Converts F-connectors to BNC connectors.



VDV814-629

F to RCA Adapter

- Converts F-connectors to RCA connectors.



VDV814-630

F-Splice Adapter 3 GHz

- Patented gripping mechanism for optimal signal strength.



VDV814-609

90° F-Adapter 3 GHz

- Perfect for tight spaces in a cabinet or against a wall.



VDV814-631

Cat. No.	Description	Pack Qty.
VDV814-629	F to BNC Adapter	2
VDV814-630	F to RCA Adapter	2
VDV814-609	F-Splice Adapter – 3 GHz	10
VDV814-631	90° F-Adapter – 3 GHz	2
VDV814-610	F-Terminator	10

F-Terminator

- Prevents extraneous signals from decreasing system performance.



VDV814-610

Splitters/Diplexer

- Over 130 dB of RFI shielding for optimal signal performance.
- Enhanced return path for improved cable modem performance.
- High return loss to minimize ghosting or pixelated images.
- F-terminators recommended for unused ports to optimize performance.

Digital Cable Splitters (5 MHz to 1 GHz)



VDV814-633



VDV814-634



VDV814-635

Cat. No.	Description	Pack Qty.
VDV814-633	2-Way Digital Cable Splitter – 5 MHz - 1 GHz	1
VDV814-634	4-Way Digital Cable Splitter – 5 MHz - 1 GHz	1
VDV814-635	8-Way Digital Cable Splitter – 5 MHz - 1 GHz	1

Satellite / Digital Cable Splitters (5 MHz to 2.3 GHz)

- High port to port isolation to reduce interference.



VDV814-636



VDV814-637

Cat. No.	Description	Pack Qty.
VDV814-636	2-Way Satellite/Digital Cable Splitter – 5 MHz - 2.3 GHz	1
VDV814-637	4-Way Satellite/Digital Cable Splitter – 5 MHz - 2.3 GHz	1

Diplexer

- Combines or separates CATV and off-air signals with/from satellite signals.



VDV814-638

Cat. No.	Description	Pack Qty.
VDV814-638	Satellite/TV Diplexer – 5 MHz - 2.3 GHz	1

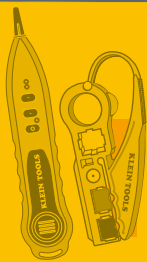

Twisted Pair Connectors



Klein's data and telephone plugs are professional-grade and deliver consistent, reliable performance.

They feature thick 50 micro-inch gold plating on the contact plates, three-pronged solid and stranded wire contacts, and durable connector housings. Expect a sure connection each and every time.



Connector Type	UY	UR	RJ11	RJ11	RJ45	
Position & Contacts	2P2C	3P3C	6P4C	6P6C	8P8C	
Connector Design	1-Piece	1-Piece	1-Piece	1-Piece	1-Piece	3-Piece
Gold Plating Thickness (microinch)			50µ"	50µ"	50µ"	50µ"
Cable Type:						
CAT 3	●	●	●	●		
CAT 5					●	
CAT 5e					●	
CAT 6						●
Solid Conductor Wire	●	●	●	●	●	●
Stranded Conductor Wire					●	●
Connector Color	Yellow	Red	Clear	Clear	Clear	Clear
Cat. No.						
Pack Size: 10					VDV826-628	
Pack Size: 25	VDV826-604	VDV826-605	VDV826-601	VDV826-600		VDV826-603
Pack Size: 50					VDV826-602	
Pack Size: 100					VDV826-611	
Crimping Type	IDC			Modular Plug Connector		
Klein Crimping Tools	D234-6, D234-6C, VDV026-049			VDV226-011, VDV226-107		

RJ45 Modular Data Plugs

- 8 position 8 contact.
- For solid or stranded conductors.



VDV826-628
(CAT 5 / CAT 5e)



VDV826-603
(CAT 6)

Cat. No.	Connector Type	Cable Type	Connector Color	Pack Qty.
VDV826-628	RJ45	CAT 5 / CAT 5e	clear	10
VDV826-602	RJ45	CAT 5 / CAT 5e	clear	50
VDV826-611	RJ45	CAT 5 / CAT 5e	clear	100
VDV826-603	RJ45	CAT 6	clear	25

RJ45 Strain Relief Boot

- Protects connector tabs from breaking, extending connector life.
- Minimizes cable bending that can reduce data speed and result in connector failure.
- For use with RJ45 modular data plugs.



VDV824-632

Cat. No.	Connector Type	Connector Color	Pack Qty.
VDV824-632	RJ45	black	10

RJ11 Telephone Plugs

- 6 position 4 contact for 1 or 2 line telephones.
- 6 position 6 contact for 1, 2 or 3 line telephones.



6P4C



6P6C



VDV826-600

Cat. No.	Connector Type	Position & Contacts	Connector Color	Pack Qty.
VDV826-601	RJ11	6P4C	clear	25
VDV826-600	RJ11	6P6C	clear	25

Insulation Displacement Connectors

- Insulation displacement connector to add or terminate a telephone line.
- Gel-filled for moisture resistance.



VDV826-604
(26-22 AWG)



VDV826-605
(26-19 AWG)

Cat. No.	Connector Type	Position & Contacts	Connector Color	Pack Qty.
VDV826-604	UY	2P2C	yellow	25
VDV826-605	UR	3P3C	red	25



Voice/Data/Video Tool Kits

Coax Installer Starter Kit – F-Connectors

- Includes the tools needed to prepare and connect F-Connectors.
- Durable nylon tool pouch designed specifically for F-connector installation tools.
- Additional pocket holds a screwdriver or common AA battery flashlights.
- Pouch includes a closeable pocket that will hold up to 25 compression F-connectors.
- Tunnel-loop accommodates up to 2" belt.

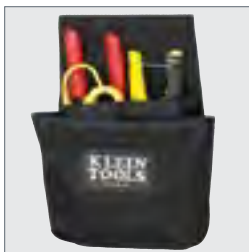

VDV012-811

Cat. No.	Set Contains	Weight
VDV012-811		1.44 lbs. (0.65 kg)
Cat. No.	Description	
63020	multi-cable cutter	
VDV110-802	radial cartridge stripper - coaxial cable, 2-level	
VDV212-008	compression crimper - compact, f-connector	
kit exclusive	5-pocket nylon tool pouch plus closeable consumables pocket	

LAN Installer Starter Kit – Modular

- Includes the tools needed to prepare, connect and test modular cables.
- Durable nylon tool pouch designed specifically for modular plug installation tools.
- Two additional pockets hold a screwdriver and common AA battery flashlights.
- Pouch includes a closeable pocket that will hold up to 25 RJ45 plugs.
- Tunnel-loop accommodates up to 2" belt.



VDV026-812

Cat. No.	Set Contains	Weight
VDV026-812		1.5 lbs. (0.68 kg)
Cat. No.	Description	
2100-8	stainless steel electrician's scissors - free-fall	
VDV226-011	ratcheting modular cutter/crimper/stripper	
VDV526-052	LAN Scout™ Jr. tester	
98554	fine point permanent marker	
kit exclusive	5-pocket nylon tool pouch plus closeable consumables pocket	

LAN Installer Starter Kit – Punchdown

- Includes the tools needed to prepare and connect 66 type and 110 type punchdown terminal blocks.
- Durable nylon tool pouch designed specifically for punchdown installation tools.
- Two additional pockets hold a screwdriver and common AA battery flashlights.
- Tunnel-loop accommodates up to 2" belt.

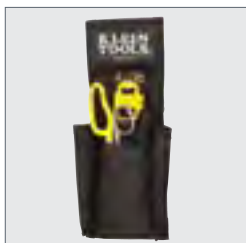

VDV027-813

Cat. No.	Set Contains	Weight
VDV027-813		.88 lbs. (0.40 kg)
Cat. No.	Description	
2100-8	stainless steel electrician's scissors - free-fall	
VDV427-047	punchdown multi-tool chassis	
VDV427-015	punchdown tool blade - 110 type	
VDV427-017	punchdown tool blade - combination 66/110 cut type	
98554	fine point permanent marker	
kit exclusive	4-pocket nylon tool pouch	

All dimensions are in inches and (millimeters).

⚠WARNING: Read carefully and understand instructions before using this tool.

⚠WARNING: NOT insulated. Will NOT protect against electrical shock.

⚠WARNING: Always wear approved eye protection.

⚠WARNING: Never use on or near live electrical circuits.



Voice/Data/Video Tool Kits

Coax Installation & Test Kit

- Includes tools needed to prepare, connect and test coax cables.
- Coax Cable Stripper 2-Level, Radial: Designed for easy single operation cable preparations.
- Compression Crimper Compact F-Connector: Crimps compression F-connectors to coaxial cable quickly and reliably.
- Coax Explorer™ Tester: Compact tool tests and verifies coaxial cable connections (good/open/short).
- Universal F-Compression Connectors - RG6 / RG6-QS: Patented universal sleeve connectors install up to 5X faster.



VDV002-818

Cat. No.	Set Contains	Weight
VDV002-818		1.1 lbs. (0.50 kg)
Cat. No.	Description	
VDV212-008	compression crimper - compact, F-connector	
VDV110-061	coax cable stripper 2-level, radial	
VDV512-057	Coax Explorer™ tester	
VDV812-606	universal F-compression connectors - RG6/RG6-QS (10 pack)	

Coax Push-On Connector Installation & Test Kit

- Includes tools needed to prepare, connect and test push-on coax cables.
- Coax Cable Stripper 2-Level, Radial: Designed for easy single operation cable preparations.
- Coax Explorer™ Tester: Compact tool tests and verifies coaxial cable connections (good/open/short).
- Push-On F-Connectors - RG6 / RG6-QS: Tool-less, patented cable grip design for easy installation and strong hold.



VDV002-820

Cat. No.	Set Contains	Weight
VDV002-820		0.28 lbs. (0.13 kg)
Cat. No.	Description	
VDV110-061	coax cable stripper 2-level, radial	
VDV512-057	Coax Explorer™ tester	
VDV812-627	push-on F-Connectors - RG6/RG6-QS (10 pack)	

Modular Installation Kit

- Includes tools needed to prepare and connect modular cables.
- Ratcheting Modular Crimper/Stripper: All-in-one tool cuts, strips and crimps paired-conductor cables (RJ11 / RJ12, RJ22, RJ45).
- Modular Data Plug - RJ45 - CAT5e: Thick 50 micro-inch gold plating and 3-pronged contacts with durable housing - 8 position, 8 contact for data cables.
- Telephone Plug - RJ11 - 6P6C: Thick 50 micro-inch gold plating and 3-pronged contacts with durable housing - for 1, 2 or 3 line telephones.



VDV226-817

Cat. No.	Set Contains	Weight
VDV226-817		0.76 lbs. (0.34 kg)
Cat. No.	Description	
VDV226-011	ratcheting modular crimper/stripper	
VDV826-628	modular data plug - RJ45 - CAT5e (10 pack)	
kit exclusive	telephone plug - RJ11 - 6P6C (10 pack)	

All dimensions are in inches and (millimeters).

⚠WARNING: Read carefully and understand instructions before using this tool.

⚠WARNING: Always wear approved eye protection.

⚠WARNING: NOT insulated. Will NOT protect against electrical shock.

⚠WARNING: Never use on or near live electrical circuits.



Voice/Data/Video Test & Measurement

NEW!

VDV Commander™

- Test coaxial, data (RJ45) and telephone (RJ11) cables – wire map, for faults, verify shielding, continuity.
- Measure cable length and distance to a fault with Time Domain Reflectometry (TDR) technology.
- Test Power over Ethernet (PoE) systems. Detect class per IEEE 802.3af/at, test loads and identify modes.
- Locate, trace and identify cables with intergrated tone generator, Link Light, Location ID remotes and Test-n-Map™ ID Remotes.
- Perform active network (Ethernet) testing. Detect and report current link speed and link capabilities for active Ethernet drops up to 1 Gbps.
- Save up to 256 tests reports and export/print as needed.



VDV501-828



VDV501-829

CE



Features	Includes
RJ-45 8-Wire Cables	●
F-connector Coaxial Cables	●
Telephone Cables	With adapter
Wiremap	●
Open Fault	●
Short Fault	●
Miswire Fault	●
Split-Pair Fault	●
Pass TIA-568A/B & Crossover/Uplink	●
Active Ethernet Detects link speed and capabilities to 1 Gbps	●
Single-End Cable Testing	●
Test-n-Map™ ID Remote (Two End Testing) Test and Identify location in one step with remote	●
PoE Power Over Ethernet Testing	●
Measures Cable Length	1500 ft. / 457 m
TDR Time Domain Reflectometry Length Measurement Method	●
$\pm(5\% + 1\text{ft.})$ $\pm(5\% + 0.3\text{m})$ Accuracy/ Measurement Resolution	●

Features	Includes
Link Light	●
ID Cable Identification	up to 20
Shield Detection	●
Voltage Warning	●
Low Battery Indicator	●
Store Test Results	256
Print Custom Reports	●
Multiple-style Tone Generator* Down to Single Conductor/Pair/Cable	4
Color LCD Display	2.7"
Multiple Languages	ENG · ESP · FRA
Ft./m Imperial or Metric Results	●
Apo Auto Power Off	●
Customizable Setup	●
USB interface (for PC connection)	MICRO
Upgradeable Firmware (via internet download & pc connection)	●

Cat. No.	Batteries	Battery Life	Height	Width	Depth	Weight (with batteries)	Included Accessories
VDV501-828	6 AA alkaline batteries included	20 hours active 10 years standby	6.8" (173 mm)	3.6" (91 mm)	1.85" (47 mm)	12 oz. (340 grams)	5 location RJ45 remotes, 5 location F-Connector remotes, 1 test cable – micro USB to USB A, 1 test cable – universal RJ12 jumper (9'), 1 test cable – RJ45 jumper (9'), 1 coax adapter – Barrel F-F Female, batteries, carrying case
VDV501-829	6 AA alkaline batteries included Probe 1 9V alkaline battery	20 hours active 10 years standby Probe 25 hrs. active 4 yrs. standby	6.8" (173 mm)	3.6" (91 mm)	1.85" (47 mm)	12 oz. (340 grams)	1 PROBEplus Tone Tracing Probe, 20 location RJ45 remotes, 20 location F-Connector remotes, 1 test cable – micro USB to USB A, 1 test cable – universal RJ12 jumper (9') 1 test cable – RJ45 jumper (9'), 1 coax adapter – Barrel F-F Female, batteries, carrying case

*Functionality requires an analog tone tracing probe - VDV500-060 (Included with Cat. No. VDV501-829).

⚠WARNING: Connecting the instrument to voltages above the Safety Extra Low Voltage range of less than 60V peak AC or DC may pose a safety hazard to the user.

⚠WARNING: The Commander™ internal components are protected up to 400V peak AC or DC. Connecting the instrument to voltages above this range may pose a safety hazard to the user and the instrument.

All dimensions are in inches and (millimeters).

⚠WARNING: Read, understand, and follow all instructions, cautions and warnings attached to and/or packed with all test and measurement devices before each use.

⚠WARNING: Always wear approved eye protection.

⚠WARNING: Do NOT use on energized circuits or cabling systems.

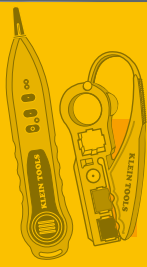

Voice/Data/Video Test & Measurement

VDV Ranger™ TDR Kit

- Test and measure cable with the latest technology.
- Time Domain Reflectometry Spread Spectrum (TDR-SS) Technology provides accuracy up to +/- (1% + 3Ft.) by eliminating interference when measuring cable.
- TDR-SS technology broadens TDR environments by operating in Safety Extra Low Voltage (SELV) rated environments as defined by IEC. (SELV is 60 volts DC or Peak AC – 45 volts RMS).
- Measure paired-conductor cable length up to 3,000 ft. (914 m) including voice, data, video, doorbell, siamese, lamp-wire and NM cables.
- Ensure compliance and identify cable runs outside specification.
- Measure cable remaining in box or on a reel.
- Simplify cable estimating and bill jobs more accurately.
- The Tone Generator traces and identifies cables. Four tone cadences available. (Requires analog tone probe: VDV526-054 or VDV500-060 – both sold separately.)
- Includes custom designed polyester carrying case.
- Adapter cord set includes BNC to F-Connector adapter, F-Connector adapter, insulated push-on F-Connector to alligator clips, insulated BNC Connector to alligator clips and insulated push-on F-Connector to RJ45 modular plug.



Features	VDV501-815
Measures Cable Length	●
(TDR-SS) Length Measurement Method	●
±(1% + 3Ft.) ±(1% + 1m) Accuracy & Length Measurement	●
Maximum Cable Length	3,000 ft / 914M
Maximum Cable Length Ranges† <i>†Must be paired conductors</i>	●
RJ45 8-Cables	0 - 1,500 Ft (457 m)
RJ11/12 6-wire Cables	0 - 2,000 Ft (609 m)
Coaxial Cable	0 - 2,000 Ft (609 m)
Electrical Cable	0 - 1,000 Ft (305 m)
Ft./m Imperial & Metric Results	●
MEM On-Board Calibration-Memory	2 Storage Locations
Open Fault	●
Short Fault	●
LCD Display	2.25 Backlit
Multiple Style Tone Generator	●
Apo Auto Power Off	●
Low Battery	●
Voltage Warning	●
Interface	Multi-Adapter Set
Carrying Case	●



VDV501-815

Cat. No.	Batteries	Battery Life	Height	Width	Depth	Weight (with batteries)
VDV501-815	four AA alkaline batteries included	15 hours active 4 years standby	6.8" (173 mm)	3.15" (80 mm)	1.30" (33 mm)	12 oz. (340 grams)

⚠WARNING: The Ranger TDR internal components are protected up to 400V peak AC or DC. Connecting the instrument to voltages above this range may pose a safety hazard to the user and the instrument.

⚠WARNING: Connecting the instrument to voltages above the Safety Extra Low Voltage range of less than 60V peak AC or DC may pose a safety hazard to the user.

All dimensions are in inches and (millimeters).

⚠WARNING: Always wear approved eye protection.

⚠WARNING: Read, understand, and follow all instructions, cautions and warnings attached to and/or packed with all test and measurement devices before each use.

⚠WARNING: Do NOT use on energized circuits or cabling systems.



Voice/Data/Video Test & Measurement

VDV Scout® Pro Tester Kits

- Test continuity on data (RJ45), voice (RJ11/RJ12) and video (F-Connector coax) connections.
- Cat. No. VDV501-814 measures cable length.
- Simultaneous testing of video and data cables saves time and improves efficiency.
- Includes RJ45 & F-Connector location ID remotes for identifying cable runs to wall outlets.
- Integrated tone generator supports multiple tones and control of pins carrying tone.
- Heavy-duty ports are designed for long life and repeated connections.
- Recessed F-Connector port for improved reliability.
- Contoured dual material chassis fits comfortably in your hand.

Features	VDV501-809 Scout Pro	VDV501-814 Scout Pro LT
RJ45 8-wire Cables	●	●
RJ11/12 6-wire Cables	●	●
F-connector Coax Cables	●	●
Continuity Testing	●	●
Measures Cable Length	—	●
Pass TIA-568A/B & Crossover/Uplink	●	●
LCD LCD Display	●	●
Wiremap	●	●
Open Fault	●	●
Short Fault	●	●
Miswire Fault	●	●
Split Pair Fault	●	●
ID Cable Identification – Locations Included	5	19
Multiple Style Tone Generator, 4 cadence	●	●
Apo Auto Power Off	●	●
Low Battery	●	●
Voltage Warning	●	●
Shield Detection	●	●
Self-Storing Remote	●	●
Carrying Case	—	●



CE



VDV501-809



VDV501-814



Self Storing Remote



RJ45, F-Connector and RJ11/12 Port

Cat. No.	Batteries	Height	Width	Depth	Included Accessories	Weight
VDV501-814	9V alkaline included	11.5" (292 mm)	8.75" (222 mm)	2.25" (64 mm)	19 location RJ45 remotes and remote holder, 19 location F-Connector remotes and remote holder, 1 F to F Barrel Connector, battery and 1 carrying case	30 (850 g)
VDV501-809	9V alkaline included	6.3" (160 mm)	2.8" (71.2 mm)	1.70" (43.2 mm)	5 location RJ45 remotes, 5 location F-Connector remotes, 1 F to F Barrel Connector, battery and 1 remote holder	10 (283 g)

All dimensions are in inches and (millimeters).

▲WARNING: Always wear approved eye protection.

▲WARNING: Read, understand, and follow all instructions, cautions and warnings attached to and/or packed with all test and measurement devices before each use.

▲WARNING: Do NOT use on energized circuits or cabling systems.



Voice/Data/Video Test & Measurement

LanMap™ Kit for VDV Scout® Pro Series Tester

- Identify and map twisted-pair infrastructure (RJ45), up to 19 locations.
- For use with VDV Scout® Pro Tester (Cat. No. VDV501-053, VDV501-809, VDV501-068, VDV501-814, VDV501-816).
- Heavy-duty design for long life and repeated connections.
- Remotes numbered 1 through 19 for fast and accurate identification.

Cat. No.	Height	Width	Depth	Weight
VDV526-055	3.0" (76 mm)	3.3" (84 mm)	1.4" (36 mm)	1.9 (56 g)

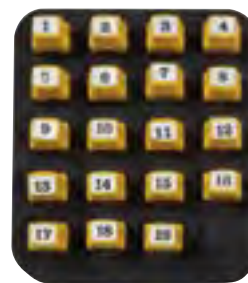

VDV526-055

CoaxMap™ Kit for VDV Scout® Pro Series Tester

- Identify and map coaxial cable infrastructure (F-Connector), up to 19 locations.
- For use with VDV Scout® Pro Tester (Cat. No. VDV501-053, VDV501-809, VDV501-068, VDV501-814, VDV501-816).
- Heavy-duty design for long life and repeated connections.
- Remotes numbered 1 through 19 for fast and accurate identification.

Cat. No.	Height	Width	Depth	Weight
VDV512-056	3.0" (76 mm)	3.3" (84 mm)	1.0" (26 mm)	5.2 (148 g)



VDV512-056

Nylon Carrying Case for VDV Scout® Pro

- Designed for use with:
 - VDV Scout® Pro Tester (VDV501-053, VDV501-809)
 - VDV Scout® Pro LT Tester (VDV501-068, VDV501-814, VDV501-816)
 - Coax Map™ Kit (VDV512-056)
 - LAN Map™ Kit (VDV526-055)
- Custom designed compartments hold and protect tester and accessories securely.
- Extra cavities for additional accessories.
- Tools and accessories not included.



Shown with (Cat. No. VDV501-809)



VDV770-080

Cat. No.	Height	Width	Depth	Weight
VDV770-080	11.5" (292 mm)	8.75" (222 mm)	2.25" (57 mm)	15 (425 g)

Coax Explorer® Testers

- Tests and verifies coaxial cable continuity.
- Compact size fits easily into pocket or pouch.
- Bright LED indicates cable status (good/open/short).
- Simple push-button operation.
- Cat. No. VDV512-057 includes color coded remotes and a convenient remote holder to test up to 4 locations.
- Batteries included.

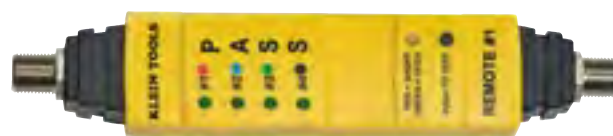

VDV512-058

Cat. No.	Location ID	Batteries	Height	Width	Depth	Weight
VDV512-057	1	lithium non-replaceable	2.7" (69 mm)	1.1" (28 mm)	0.7" (18 mm)	1.3 (37 g)
VDV512-058	4	lithium non-replaceable	5.6" (142 mm)	1.1" (28 mm)	0.6" (16 mm)	3.3 (94 g)



VDV512-057

All dimensions are in inches and (millimeters).

▲WARNING: Always wear approved eye protection.

▲WARNING: Read, understand, and follow all instructions, cautions and warnings attached to and/or packed with all test and measurement devices before each use.

▲WARNING: Do NOT use on energized circuits or cabling systems.



Voice/Data/Video Test & Measurement

LAN Scout® Jr. Tester

- Tests continuity on twisted pair data wiring (RJ45) connections.
- Integrated tone generator supports multiple tones and control of pins carrying tone.
- Heavy-duty ports are designed for long life and repeated connections.
- Compact, contoured dual-material chassis fits comfortably in your hand.

Features	VDV526-052
RJ45 8-wire Cables	●
Continuity Testing	●
Pass TIA-568A/B & Crossover/Uplink	●
LCd LCD Display	●
Wiremap	●
Open Fault	●
Short Fault	●
Miswire Fault	●
Split Pair Fault	●
Multiple Style Tone Generator, 4 cadence	●
Apo Auto Power Off	●
Low Battery	●
Voltage Warning	●
Shield Detection	●
Self-Storing Remote	●



RJ45 Port



Self Storing Remote



VDV526-052

Cat. No. w	Batteries	Height	Width	Depth	Weight
VDV526-052	6V - 4 x LR44 alkaline included	4.6" (117 mm)	2.3" (58 mm)	1.1" (28 mm)	4.0 (115 g)

VDV Distance Meter™

Features	VDV501-089
Measures Cable Length	●
Capacitance Length Measurement Method	●
±(5% + 1Ft.) Accuracy	●
1,500 ft (457 m) Maximum Cable Length Measurement	●
Ft./m Imperial & Metric Results	●
RG59, RG6, RG11 Cat3, Cat5e, Cat6 Preprogrammed Cable Values	1
MEM Programmable Cable Value	1
Display	2.25" LCD
Multiple Interface	F-Connector / Alligator Clips / RJ11/RJ45 Modular Plug
Short Fault	●
Open Fault	●
Voltage Warning	●
Apo Auto Power Off	●
Low Battery	●



VDV501-089

- Cable Length Measurement.
- Determines cable length up to 1,500 ft. on most paired conductor cables with accuracy +/- (5% + 1Ft.).
- Cable Manager measures cable remaining in box or on reel.
- Simplifies cable estimating and helps you bill jobs more accurately.

Cat. No.	Battery	Battery Life	Height	Width	Depth	Weight (with battery)
VDV501-089	One 9V alkaline battery included	425 hours active 4 years standby	4.9" (123 mm)	2.7" (69 mm)	1.4" (35 mm)	7.5 oz. (213 grams)

All dimensions are in inches and (millimeters).

▲WARNING: Always wear approved eye protection.

▲WARNING: Read, understand, and follow all instructions, cautions and warnings attached to and/or packed with all test and measurement devices before each use.

▲WARNING: Do NOT use on energized circuits or cabling systems.

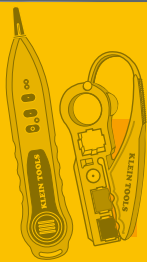

Voice/Data/Video Test & Measurement

PROBEplus – Tone Tracing Probe

- Trace wire paths and identify cables in common wiring systems.
- Amplifier overload LED improves accuracy, warning against misreads.
- Dual mode power button with Power-On LED indicator – tap or hold.
- Recessed buttons prevent accidental operation.
- Designed for use with Klein Tools VDV test tools (Cat. No. VDV500-051, VDV526-054, VDV526-052, VDV501-053, VDV501-809, VDV501-068, VDV501-814, VDV501-815, VDV501-816, VDV501-828 and VDV501-829)
- Works with many other manufacturers' analog tone generators.
- Replacement tips available (Cat. No. VDV999-065).



CE

VDV500-060

Cat. No.	Battery	Battery Life	Height	Width	Depth	Weight
VDV500-060	9V	25 hours active 4 years standby	9.9" (252 mm)	2.0" (51 mm)	1.14" (29 mm)	4.4 oz. (112 g) without battery 6.0 oz. (170 g) with battery

Features	VDV500-060
O.L. Amplifier Overload Indication	●
Adjustable Digital Volume Control	●
Tap-Mode Operation	●
Hold-Mode Operation	●
Power-On LED Indicator	●
Visual Notification	●
Apo Auto Power-Off	●
Low Battery Indicator	●
Replaceable Tip	●
Lanyard Attachment Loop	●

TONEcube – Tone Generator

- Trace wire paths and identify cables in common wiring systems.
- Five discrete tracing tones.
- Constant output level over useful battery life.

CE

Features	VDV500-051
Tones	5
Heavy-Duty Leads	●
Rugged Universal RJ11/RJ12/ RJ45 Modular Plug	●
Continuity Testing	●
O.L. Voltage Overload Protection	●
+/- Line Status & Polarity	●
Power-On Flashing LED Indicator	●
Apo Auto Power-Off	●
Low Battery Indicator	●
Lanyard Attachment Loop	●

Cat. No.	Battery	Battery Life	Height	Width	Depth	Weight
VDV500-051	9V	120 hours active 4 years standby	2.7" (70 mm)	2.5" (63 mm)	1.42" (36 mm)	3.4 oz. (96 g) without battery 5.0 oz. (142 g) with battery



VDV500-051

- Heavy-duty leads with rugged dual-mode modular plug for direct connection to RJ11 RJ12 and RJ45 jacks.
- Momentary slide switches prevent accidental operation.
- Designed for use with Klein Tools VDV test tools (Cat. No. VDV526-054, VDV501-060).
- Works with many other manufacturers' analog tone probes.

All dimensions are in inches and (millimeters).

▲WARNING: Always wear approved eye protection.

▲WARNING: Read, understand, and follow all instructions, cautions and warnings attached to and/or packed with all test and measurement devices before each use.

▲WARNING: Do NOT use on energized circuits or cabling systems.



Voice/Data/Video Test & Measurement

TONEcube & PROBEplus Kit

- Trace wire paths and identify cables in common wiring systems.

Kit includes:

- TONEcube Tone Generator and PROBEplus Tone Tracing Probe.
- Custom designed padded zipper bag.



Cat. No.	Set Contains:	Weight
VDV500-808		16.0 oz. (454 g) with batteries

Cat. No.	Description
VDV500-051	TONEcube tone generator
VDV500-060	PROBEplus tone tracing probe
kit exclusive	nylon pouch



VDV500-808

TraceAll™ Tone & Probe

- Trace wire paths and identify cables in common wiring systems.
- Heavy-duty RJ11 jack on tone generator for long life and repeated connections.
- Includes RJ11 adapter to convert tone generator to an alligator-clip configuration.
- Dual material chassis fits comfortably in your hand.
- Replacement tips available (Cat. No. VDV999-059).



VDV526-054

Features VDV526-054

	Adjustable Volume	●
	Tone Generator, 2 Cadence	●
	Self-Storing Remote	●
	Replaceable Tip	●
	Auto Power-Off	●



Self Storing Remote



Adapter



Cat. No.	Batteries	Height	Width	Depth	Weight	Included Accessories
VDV526-054	6V – 4 x LR44 alkaline included	8.9" (226 mm)	1.7" (43 mm)	1.2" (31 mm)	5.0 (140 g)	RJ11 to alligator clip adapter, batteries

All dimensions are in inches and (millimeters).

▲WARNING: Read, understand, and follow all instructions, cautions and warnings attached to and/or packed with all test and measurement devices before each use.

▲WARNING: Always wear approved eye protection.

▲WARNING: Do NOT use on energized circuits or cabling systems.



Strippers, Cutters & Crimpers

Manufactured with the needs of the professional tool user in mind, Klein strippers, cutters, and crimpers are designed to get jobs done with precision and quality.

F O R P R O F E S S I O N A L S . . . S I N C E 1 8 5 7 ®

Strippers, Cutters & Crimpers



Wire Strippers/Cutters

Features:

KLEIN-KURVE®

Klein-Kurve®
comfort grip handles

Screw shearing holes.

Wire looping and bending holes.

Strong gripping serrated nose for easy bending, shaping, and pulling of wire.

Coil spring provides fast self-opening action.

Double dipped comfort grips.



Precision ground stripping holes.

Handy closure lock for convenient storage.

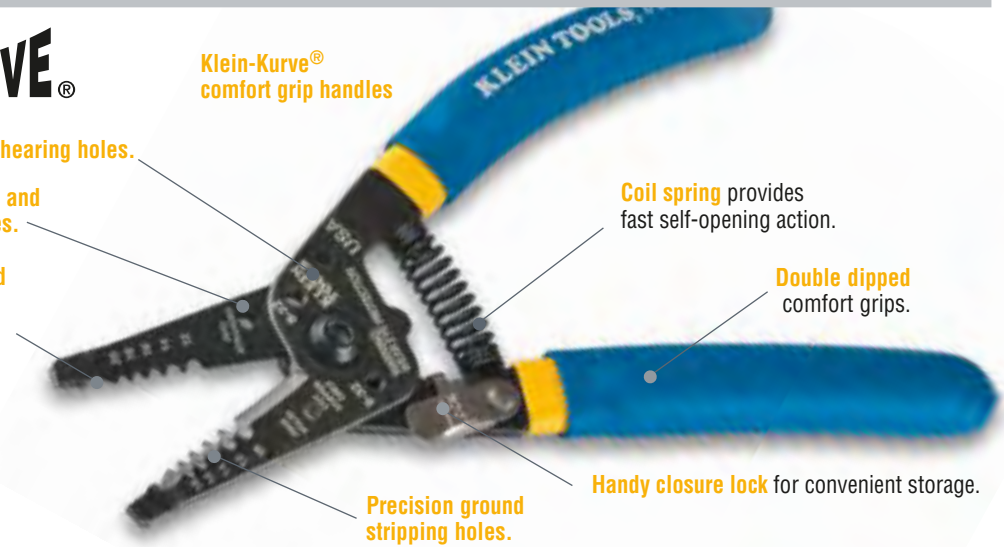

Wire Strippers/Cutters KLEIN-KURVE®

Additional Features:

- Easy-to-read markings.
- Precision shear-type blades.
- Cleanly shears 6-32 and 8-32 screws.



11054

Cat. No.	Handle Color	Overall Length	Strips and Cuts	Screw Shearing	Weight (lbs.)
11053	blue/red	7-1/8" (181 mm)	6 – 12 AWG stranded (10 mm ² – 2.5 mm ²)	6-32 & 8-32	.34
11054	blue/white	7-1/8" (181 mm)	8 – 16 AWG solid (8.4 mm ² – 1.3 mm ²) & 10 – 18 AWG stranded (5.3 mm ² – .82 mm ²)	6-32 & 8-32	.34
11055	blue/yellow	7-1/8" (181 mm)	10 – 18 AWG solid (4.0 mm ² – .75 mm ²) & 12 – 20 AWG stranded (2.5 mm ² – .50 mm ²)	6-32 & 8-32	.34
11057	blue/red	7-1/8" (181 mm)	20 – 30 AWG solid (.50 mm ² – .14 mm ²) & 22 – 32 AWG stranded (.34 mm ² – .05 mm ²)	6-32 & 8-32	.32

Dual NM Cable Strippers/Cutters KLEIN-KURVE®

Additional Features:

- 12/2, and 14/2 stripping slots quickly remove outer jacket of Type NM-B nonmetallic-sheathed cable.
- Stripping holes easily remove insulation on 12 and 14 AWG solid wire.
- Precision shear-type blades for square, clean cuts on solid copper wire.
- Narrow nose fits into tight places.



K1412

Cat. No.	Handle Color	Overall Length	Strips and Cuts	Type NM-B Cable	Screw Shearing	Weight (lbs.)
K1412	yellow/white	7-3/4" (197 mm)	12 & 14 AWG solid (2.5 mm ² & 1.5 mm ²)	12/2 & 14/2	6-32 & 8-32	.41

Dual NMD-90 Cable Strippers/Cutters KLEIN-KURVE®

Additional Features:

- Quickly removes outer jacket of **Canadian** NMD-90 Romex® Cable.
- Strips, cuts, and loops 12 & 14 AWG solid wires.
- Strips, cuts, and loops 14 & 16 AWG stranded wires.
- Cleanly shears 6-32 and 8-32 screws.

Romex® is a registered trademark of Southwire Company.



K1412CAN

Cat. No.	Handle Color	Overall Length	Strips and Cuts	Type NMD-90 Cable	Screw Shearing	Weight (lbs.)
K1412CAN	yellow/white	7-3/4" (197 mm)	12 & 14 AWG solid (2.5 mm ² & 1.5 mm ²) 14 & 16 AWG stranded (1.5 mm ² & 1.0 mm ²)	12/2 & 14/2	6-32 & 8-32	.41

All dimensions are in inches and (millimeters).

⚠WARNING: NOT insulated. Plastic-dipped or slip-on plastic handles are NOT intended for protection against electrical shock.

⚠WARNING: Never use on or near live electrical circuits.

⚠WARNING: Always wear approved eye protection.



Wire Strippers/Cutters

Features:



Strippers, Cutters & Crimpers

Wire Strippers/Cutters

Additional Features:

- Compact, lightweight wire-stripping and cutting tools.
- Narrow nose fits into tight places.
- Hardened steel with precision ground stripping holes.
- Do not use for cutting steel wire or bolts.



11045

Cat. No.	Handle Color	Overall Length	Strips and Cuts	Weight (lbs.)
11045	yellow	6-1/4" (159 mm)	10 – 18 AWG solid (4.0 mm ² – .75 mm ²)	.27
11046	red	6-1/4" (159 mm)	16 – 26 AWG stranded (1.0 mm ² – .14 mm ²)	.27
11047	yellow	6-1/4" (159 mm)	22 – 30 AWG solid (.34 mm ² – .05 mm ²)	.27
11049	red	6-1/4" (159 mm)	8 – 16 AWG stranded (6 mm ² – 1.0 mm ²)	.27

Dual-Wire Stripper/Cutter

Additional Features:

- Strips two wires in a single motion.
- Paired stripping holes for 14 and 12 AWG solid wire.
- One stripping hole for 10 AWG solid wire.
- Shear-type cutting blades for square, clean cuts.
- Narrow nose fits into tight places.
- Hardened steel with precision ground stripping holes.



11048

Cat. No.	Handle Color	Overall Length	Strips and Cuts	Weight (lbs.)
11048	yellow	6-1/4" (159 mm)	10, 12, 14 AWG solid (4.0 mm ² , 2.5 mm ² , 1.5 mm ²)	.27



SOLID
10, 12, 14 AWG

All dimensions are in inches and (millimeters).

⚠WARNING: NOT insulated. Plastic-dipped or slip-on plastic handles are NOT intended for protection against electrical shock.

⚠WARNING: Never use on or near live electrical circuits.

⚠WARNING: Always wear approved eye protection.

Wire Strippers/Cutters

Wire Stripper/Cutter

- Strips six standard wire sizes without nicking wire.
- Scissors action of 1/2" (13 mm) wide cutter makes clean cuts with little effort.
- Serrated nose jaws to bend, shape or pull wire; holes for looping wire ends.
- Spring-loaded for self-opening action.
- Comfortable, plastic-covered handles.



1011

Cat. No.	Overall Length	Strips and Cuts	Handle Color	Weight (lbs.)
1011	6-1/8" (156 mm)	10 – 20 AWG solid & stranded (4.0 mm ² – .50 mm ²)	blue	.23
1011M	6-1/8" (156 mm)	0.15 - 4.0 mm ² stranded wire	blue	.23

Adjustable Wire Strippers/Cutters — Solid and Stranded Wire

- A handy, light, compact tool for stripping insulation.
- Convenient hole for looping or bending wire.
- Black-oxide finish with plastic-dipped handles.
- Cuts, strips, and loops 12-26 solid and stranded wire.
- Adjustable slide stop with set screw for repeat stripping work.



1004

Cat. No.	Hold-Open Spring	Overall Length	Strips and Cuts	Handle Color	Weight (lbs.)
1004	yes	5" (127 mm)	12 – 26 AWG solid & stranded (2.5 mm ² – 0.14 mm ²)	yellow	.18
1003	no	5" (127 mm)	12 – 26 AWG solid & stranded (2.5 mm ² – 0.14 mm ²)	yellow	.14

SOLID
12 – 26 AWG

STRANDED
12 – 26 AWG

Adjustable Wire Stripper — Solid and Stranded Wire

- Simply dial desired wire size for fast, easy stripping.
- Adjustable tool makes short work of cutting and stripping operations.
- Finely honed nose cutter easily gets into tight areas.
- Wire gauge dial sets stripping dies to proper size, helps prevent nicked wire.
- Black-oxide finish with plastic-dipped handles.
- Spring-loaded design – tool opens automatically after each action.



74007

Cat. No.	Overall Length	Strips and Cuts	Handle Color	Weight (lbs.)
74007	5-1/8" (130 mm)	12 – 24 AWG solid & stranded (2.5 mm ² – .25 mm ²)	yellow	.15

SOLID
12 – 24 AWG

STRANDED
12 – 24 AWG

Katapult® Wire Stripper/Cutter

KATAPULT

- Quick and easy 8-22 AWG wire stripping and cutting.
- Compound action wire stripping: grip and strip via single action squeezing motion.
- Precision machined stripping holes easily remove jacket insulation without damaging the wire.
- Remove up to 1" (24 mm) in length of the insulation layer (jacket layer) in a single step.
- Tension loaded wire-grip gently holds the cable in place while retaining the cable geometry.
- Recoil spring design returns tool to ready position upon cycle completion.
- Cast alloy chassis with heavy-duty Ecoat finish for corrosion resistance and durability.
- Additional precision machined steel cutting blades available.



11063W

Cat. No.	Color	Strips	Overall Length	Weight
11063W	blue/black	8-22 AWG (6 mm ² – .34 mm ²)	6.6" (168 mm)	12.1 oz. (0.34 g)

Cat. No.	Weight	
Replacement Blades Sets		
VDV110-046	RG6 coaxial cable replacement blades	.01
11082	10 AWG max wire cutting blades	.01
11073	16 – 26 AWG (1.0 mm ² – .14 mm ²)	.01
Wire Stop/Gauge		
11081	adjustable wire stop	.01

All dimensions are in inches and (millimeters).

⚠WARNING: NOT insulated. Will NOT protect against electrical shock.

⚠WARNING: Never use on or near live electrical circuits.

⚠WARNING: Always wear approved eye protection.



Wire Strippers/Cutters

Self-Adjusting Wire Stripper/Cutter

- Strips 10-20 AWG solid, 12-22 AWG stranded, and 12/2 & 14/2 Romex® wire.
- Adjustable stopper to control the length of the core strip.
- Convenient wire cutter in handle.
- Grooved grips are designed for added comfort.



Cat. No.	Strips / Cuts	Length	Width	Depth	Weight (lbs.)
11061	10-20 AWG solid 12-22 AWG stranded 12/2 & 14/2 Romex®	8.25" (210 mm)	3.75" (95 mm)	1.25" (32 mm)	0.79

11061

Romex® is a registered trademark of Southwire Company.

Combination Wire-Stripping and Cutting Tools

Multi-Purpose 6-in-1 Tool

- Cleanly shears bolts.
- Easily cuts and strips wire.
- Measures stud sizes.
- Gauges wire sizes.
- Crimps insulated terminals.
- Plastic-covered cushioned handles for comfort.



1000

Cat. No.	Overall Length	Strips and Cuts	Bolt Sizes	Handle Color	Weight (lbs.)
1000	7-3/4" (197 mm)	8 – 22 AWG solid (6.0 mm ² – .34 mm ²), 10-16 AWG stranded (4.0 mm ² – 1.0 mm ²)	4-40, 6-32, 8-32, 10-24, 10-32	red	.44

Multi-Purpose Electrician's Tool — 8-22 AWG

- Two wire cutters—one at tip, the other halfway back near stripping holes—double the utility of this tool.
- Color-coded crimping dies for 10-22 AWG insulated and non-insulated terminals.
- Cleanly shears bolts.
- Pivot nut adjusts tension.
- Wire-looping holes near tip.
- Full-sized, plastic-covered cushioned handles for comfort.



1001

Cat. No.	Overall Length	Strips and Cuts	Bolt Sizes	Handle Color	Weight (lbs.)
1001	8-1/2" (216 mm)	8 – 26 AWG solid (6.0 mm ² – .14 mm ²) 10 – 26 AWG stranded (4.0 mm ² – .14 mm ²)	4-40, 6-32, 8-32, 10-24, 10-32	red	.47

Long-Nose Multi-Purpose Tool

- Easily cuts and strips wire.
- Narrow, serrated pliers nose to pull, loop, and bend wire.
- Long, curved cutting blade.
- Cutters and strippers are in front of the pivot for maximum ease-of-use in reaching into tight places.
- Crimps insulated and non-insulated terminals and 7 to 8 mm ignition terminals.
- Cleanly shears bolts.
- Plastic-covered cushioned handles for comfort.



1010

Cat. No.	Overall Length	Bolt Sizes	Strips and Cuts	Connectors	Handle Color	Weight (lbs.)
1010	8-1/4" (210 mm)	4-40, 5-40, 6-32, 8-32, 10-32, 10-24	10 – 22 AWG (4.0 mm ² – .34 mm ²)	10 – 22 gauge	blue	.43

All dimensions are in inches and (millimeters).

⚠WARNING: NOT insulated. Plastic-dipped or slip-on plastic handles are NOT intended for protection against electrical shock.

⚠WARNING: Never use on or near live electrical circuits.

⚠WARNING: Always wear approved eye protection.



Combination Tools

Trip-Saver® – Stainless Steel

- Unique multi-tool addresses the special needs of electricians and maintenance professionals while providing many other features handy on any job.
- Specially designed locking “L” handle snaps securely into the “L” channel, locking the fully opened blade or implement in place during use.
- Features the following:
 Needle-Nose Pliers, Beveled Wire Cutter, Toothed Pipe Grippers, Files (coarse and fine), 5-Slot Wire Stripper (10-18 AWG), Wire-Looping Hole, Scraper, Awl/Reamer, Serrated Sheepsfoot Knife, Clip-Point Knife, Standard/Metric Ruler, Drywall Saw, Locking “L” Handle, #1 and #2 Phillips Hex Bits, Small-Slotted Hex Bit, Large-Slotted Hex Bit, 1/4" Socket Adapter, Lanyard Hole, Nylon Pouch.



1016

Cat. No.	Overall Length	Weight (lbs.)
1016	5-3/4" (143 mm)	.95

▲WARNING: Close handles to lock blade in place before use.

NM Cable Ripper

- Easy-to-use cable ripper.
- Slit the outer jacket of Romex® cable (all sizes) and other nonmetallic (type NM) sheathed cable.
- Measure conductor wire gauge.



74017

Cat. No.	Overall Length	Slits	Measures Wire Gauge	Weight (lbs.)
74017	4" (102 mm)	all sizes of Romex® and NM	8 – 14 AWG (6 mm ² – 1 mm ²)	.08

Romex® is a registered trademark of Southwire Company.

Crimping Tools

Crimping/Cutting Tools — Non-Insulated/Insulated Terminals

- Crimping die marked for insulated and non-insulated solderless terminals and connectors.
- Tapered nose design for working in confined spaces.
- Specially hardened wire cutter in nose.
- Hot-riveted joint for smooth action and no handle wobble.



1005

Cat. No.	Handle Color	Crimps	Overall Length	Weight (lbs.)
1005	red	10 – 22 AWG	9-3/4" (248 mm)	.80
Journeyman™ Series – Dual-material handles				
J1005	red/black	10 – 22 AWG	9-3/4" (248 mm)	.84

Crimping/Cutting Tool — Non-Insulated Terminals

- Designed for crimping non-insulated solderless terminals and connectors.
- Specially hardened wire cutter in nose.
- Tapered nose for working in confined spaces.
- Plastic-dipped cushioned handles for comfort.



1006

Cat. No.	Handle Color	Crimps	Overall Length	Weight (lbs.)
1006	black	10 – 22 AWG	9-3/4" (248 mm)	.85

All dimensions are in inches and (millimeters).

▲WARNING: NOT insulated. Plastic-dipped or slip-on plastic handles are NOT intended for protection against electrical shock.

▲WARNING: Never use on or near live electrical circuits.

▲WARNING: Always wear approved eye protection.



Crimping Tools

Large Crimp Tool — Compound-Action



- Crimps #6-4/0 AWG battery lugs and terminals.
- Ultra-comfortable hand grips for easy use.
- All-in-one, integral crimp nest. No removable parts or rotating dies.
- High-leverage handles and compound-action mechanism for superior mechanical advantage.
- Adjustment screw allows user to control crimp depth.

Cat. No.	Crimps	Handle Color	Overall Length	Weight (lbs.)
2006	#6 – 4/0 AWG battery lugs and terminals	red	19-1/2" (495 mm)	3.80

2006

Ratcheting Crimpers

Full-Cycle Ratcheting Crimper — Insulated Terminals

- Crimps insulated terminals in wire sizes 22-16 (front cavity), 16-14 (middle cavity), and 12-10 (rear cavity).
- Color-coded wire size markings.
- Compound lever-action of narrow-span handles puts more crimping power into each squeeze.
- Comfort-grip plastic handles.



T1715

Cat. No.	Crimps	Handle Color	Overall Length	Weight (lbs.)
T1715	10 – 22 AWG	black	9" (229 mm)	1.05

Compound-Action Ratcheting Crimper — Insulated Terminals

- Compound-action tool crimps 10-22 AWG insulated terminals to meet or exceed MIL-SPEC pull-out tests.
- Built-in ratchet with safety release assures uniform crimps every time.
- Compound lever-action of narrow-span handles puts more crimping power into each squeeze.
- Special locator quickly positions terminal for double crimp.
- Comfort-grip plastic handles.



T1710

Cat. No.	Crimps	Handle Color	Overall Length	Weight (lbs.)
T1710	10 – 22 AWG	black	9" (229 mm)	1.05

All dimensions are in inches and (millimeters).

⚠WARNING: NOT insulated. Plastic-dipped or slip-on plastic handles are NOT intended for protection against electrical shock.

⚠WARNING: Never use on or near live electrical circuits.

⚠WARNING: Always wear approved eye protection.



Cable & Bolt Cutters

Klein exceeds the highest of standards to create superior cable and bolt cutters, offering greater cutting power, clean and precise cuts, as well as long life. Klein cable and bolt cutters are a cut above the rest.

For Professionals... Since 1857®



Cable Cutters

Features:

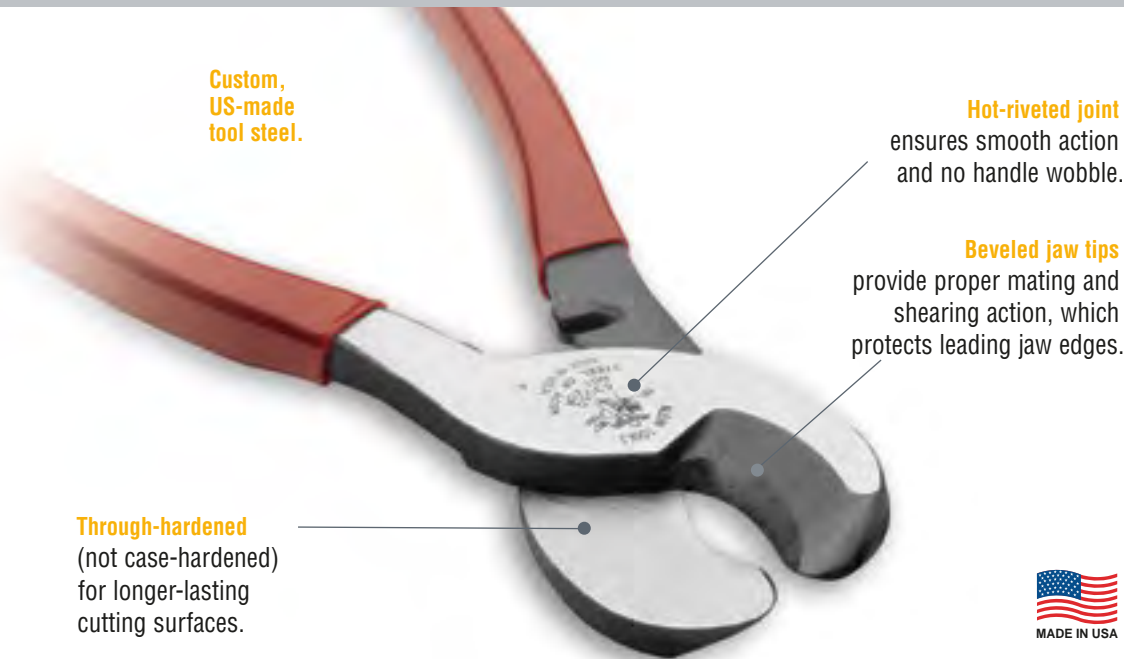

High-Leverage Cable Cutters

Additional Features:

- High-leverage design for exceptional cutting capability.
- Precision, one-hand shearing action.
- Cable-gripping shear-type jaws.
- Perfect for working in confined spaces.
- Can be carried in most tool pouches.



63050

⚠WARNING: Do NOT use to cut steel or ACSR.

Cat. No.	Overall Length	Handle Color	Maximum Cable Cutting Capacity	Weight
63050	9-1/2" (241 mm)	red	4/0 aluminum, 2/0 soft copper, 100-pair 24 AWG communications cable	.90 lbs.
Journeyman Series – Dual-material handles				
J63050	9-9/16" (243 mm)	red and black	4/0 aluminum, 2/0 soft copper, 100-pair 24 AWG communications cable	.98 lbs.

Multi-Cable Cutter **KLEIN-KURVE®**

- Hardened steel precision-ground cutting blades for long life.
- Copper curved cutter cleanly cuts round copper cable without compression or frayed ends.
- Anvil cutter for solid and stranded copper wire up to 12 AWG and stainless steel up to .032" (.81 mm) diameter.
- Mild steel cutter for conductors up to .080" (2 mm) diameter.
- Curved cutter for solid and stranded copper wire up to 8 AWG, multi-conductor cable up to 1/2" (13 mm) diameter and coaxial cable RG-6 Quad, RG-59, and RG-62.
- Double-dipped grips for comfort.
- Coil spring provides fast self-opening action.
- Holes for looping and bending wire.
- Handy closure lock for convenient storage.



63020



Cat. No.	Overall Length	Screw Shearing	Handle Color	Weight
63020	7" (177 mm)	6-32 & 8-32	red	.44 lbs.

All dimensions are in inches and (millimeters).

⚠WARNING: Always wear approved eye protection.

⚠WARNING: NOT insulated. Plastic-dipped or slip-on plastic handles are NOT intended for protection against electrical shock.



Cable Cutters

Cable Cutters — Coaxial

- Cable-gripping jaws quickly score jacket and insulation, and easily cut through copper inner conductor.
- Blades cleanly cut aluminum and copper coaxial cable without compression and frayed ends.
- Forged body with heat-treated and precision-ground steel blade withstands frequent cutting.
- Hot-riveted design requires no adjustment while maintaining a smooth, precise operation.
- Compact, lightweight design fits perfectly in any professional's tool pouch.
- Handles are plastic-coated for maximum comfort and gripping power.
- When cutting drop wire with an inner steel conductor, we recommend Cat. No. D2000-28 diagonal-cutting pliers.



63028



63030

▲WARNING: Do NOT use to cut steel or ACSR.

Cat. No.	Overall Length	Soft Cable-Cutting Maximum Capacity	Handle Color	Weight
63028	8-1/4" (216 mm)	.75" (19 mm) diameter	yellow	.80 lbs.
63030	8-1/4" (216 mm)	1" (25 mm) diameter	blue	.83 lbs.

Compact Cable Cutter

- Precise, one-hand shearing action cuts 24 AWG copper, aluminum multi-strand cable and wire, and 100-pair telephone cable.
- Special shear angle cuts cleanly without compression to cable geometry for telecom cable work.
- Heat-treated, high-carbon steel shearing edges for long life.
- Forged body with 3/8" (10 mm) case-hardened rivet.
- Plastic-dipped handles for comfort.
- Not designed for cutting steel or ACSR.



63055

▲WARNING: Do NOT use to cut steel or ACSR.

Cat. No.	Overall Length	Maximum Cable Cutting Capacity	Handle Color	Weight
63055	8" (203 mm)	24 AWG copper, aluminum multi-strand cable and wire, and 100-pair telephone cable	red	.65 lbs.

All-Purpose Shears and BX Cutter

- High-leverage, shear-type design for one-hand operation.
- Lightweight and compact.
- Stripping notch for added convenience.
- Cuts a variety of materials including cable, sheet metal, steel strapping, and bundling wire.
- Handle cavity is designed to restore BX cable to original shape after cutting.
- Plastic-dipped handles for comfort.



1104

Cat. No.	Overall Length	Length of Cut	Handle Color	Weight
1104	7-5/8" (194 mm)	7/8" (22 mm)	red	.60 lbs.

Heavy-Duty Cable Shears

- Heavy-duty, tempered steel blades.
- Blades grip cable and cut easily at center of jaws.
- Lock keeps handles closed for easy storage.
- Comfortable, plastic-coated handles for steady grip.
- Hardened steel, precision cutting blades for long service life.
- Unique triangular jaws cleanly cut cable without compression or frayed ends.
- Lightweight tool perfect for overhead cutting.



63016

Cat. No.	Overall Length	Maximum Cable Cutting Capacity	Handle Color	Weight
63016	7-1/2" (191 mm)	up to 1/4" copper and mild steel strands, up to 3/16" aircraft cable, wire rope, aluminum and copper rods, up to 5/32" for steel & iron rods	blue	.65 lbs.

All dimensions are in inches and (millimeters).

▲WARNING: Always wear approved eye protection.

▲WARNING: NOT insulated. Plastic-dipped or slip-on plastic handles are NOT intended for protection against electrical shock.



Cable Cutters

Utility Cable Cutter

- Forged steel with black-oxide finish for long life.
- Shear-type hook jaws grab and hold cable while shear-cutting action makes clean cuts.
- Beveled tips for positive mating.
- Hinge bolt with pin-set nut for proper blade tension.
- Non-slip vinyl grips.



63035

Cat. No.	Overall Length	MCM Cable-Cutting Maximum Capacity*	Handle Color	Weight
63035	16-3/4" (425 mm)	350 copper, 350 aluminum	red	1.70 lbs.

* Not designed for cutting steel or ACSR.

Wire Rope Cutter

- Shear type blades for square, clean cuts.
- All forged construction; USA Steel.
- Non-slip vinyl grips.
- Hinge bolt with pin-set nut for proper blade tension.
- Cuts wire up to 9/32" (7 mm) and Stoffel® container seals.



63035SC

Cat. No.	Overall Length	Cuts	Maximum Cutting Capacity	Handle Color	Weight
63035SC	18" (457 mm)	Stoffel Seals®	9/32" (7 mm) wire rope and cables	red	2.00 lbs.

Stoffel® is a registered trademark of Stoffel Seals Corporation.

Standard Cable Cutters

- Lightweight, yet efficient shear-type cable cutters.
- Replaceable hook-jaw blades grab and hold cable while shear-cutting action makes clean cuts.
- Exceptionally strong fiberglass handles with heavy vinyl grips for comfort and slip resistance.
- Heavy-duty pins in head serve as blade-stops.
- Jaws are forged tool steel with black-oxide finish for long life.
- Beveled tips assure positive mating, and hinge on a rugged bolt with a pin-set nut to maintain proper blade tension.
- Makes a clean, even cut for ease in fitting lugs and terminals.
- Not designed for cutting steel or ACSR.
- Includes rubber sleeves (Cat. No. 63041TH).



63041TH

Cat. No.	Overall Length	Soft Cable-Cutting Maximum Capacity	MCM Cable-Cutting Maximum Capacity	Weight
63041	25-1/2" (648 mm)	1-3/8" (35 mm) diameter	500 copper, 750 aluminum	5.25 lbs.
63041TH	25-1/2" (648 mm)	1-3/8" (35 mm) diameter	500 copper, 750 aluminum	5.25 lbs.
63045	32" (813 mm)	1-3/4" (44 mm) diameter	1000 copper, 1200 aluminum	8.00 lbs.

Replacement Cable Cutter Heads (complete)

Fits Klein Cat. No.

63081	63041	2.05 lbs.
63090	63045	3.30 lbs.

All dimensions are in inches and (millimeters).

▲WARNING: Do NOT use to cut steel or ACSR.

▲WARNING: Always wear approved eye protection.

▲WARNING: NOT insulated. Plastic-dipped or slip-on plastic handles are NOT intended for protection against electrical shock.



Cable Cutters

Communications Cable Cutter

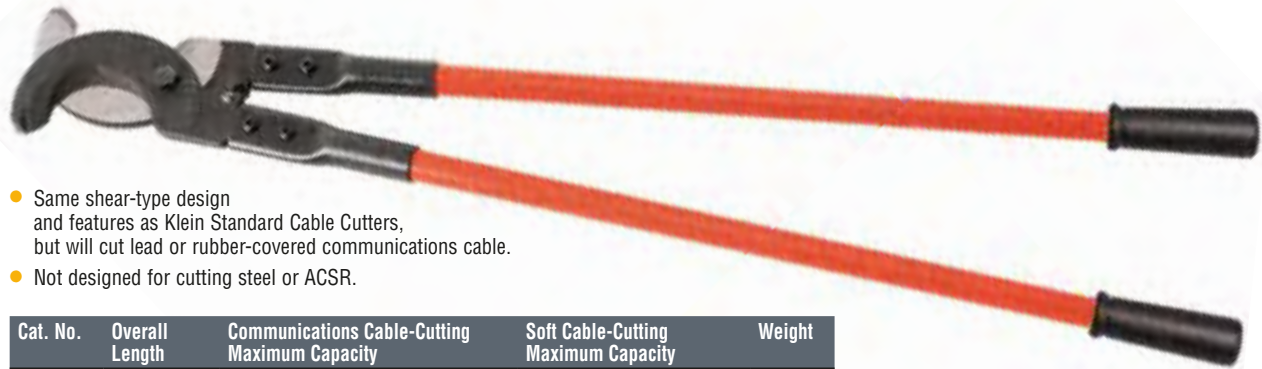

- Same shear-type design and features as Klein Standard Cable Cutters, but will cut lead or rubber-covered communications cable.
- Not designed for cutting steel or ACSR.

Cat. No.	Overall Length	Communications Cable-Cutting Maximum Capacity	Soft Cable-Cutting Maximum Capacity	Weight
63047	37" (940 mm)	900-pair soft copper and aluminum	up to 2-1/4" (57 mm) diameter	8.55 lbs.
Replacement Cable Cutter Heads (complete)			Fits Klein Cat. No.	
63110			63047	3.50 lbs.

63047

Ratcheting Cable Cutters

- High-leverage ratchet mechanism for single-handed cutting of copper and aluminum cables, leaving no burrs or sharp edges.
- Patented two-step ratchet mechanism requires fewer strokes per cut.
- Quick release lever opens blades easily in every cutting position. (Allows removal of the cable before completion of cut).
- Precision ratcheting mechanism holds cable tight and allows rapid, straight cuts with minimum effort.
- Hardened steel cutting blades for lasting strength and sharpness.
- Plastic covered handles with hand guards for comfort and firm grip.
- Locking lever keeps handles closed for easy transport; fits in a toolbox or bag.
- One-year warranty.



63060

NEW!



63711

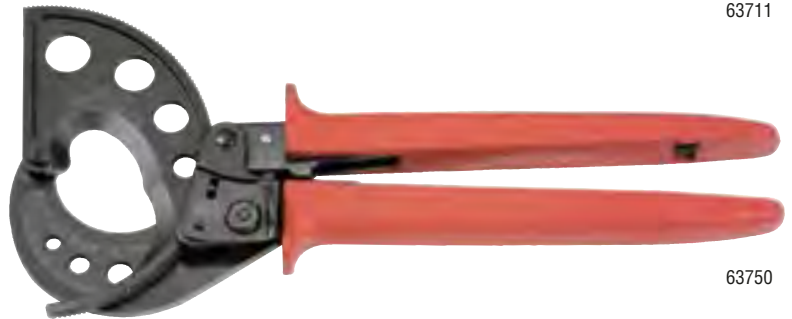

63750

⚠ WARNING: Do NOT use to cut steel or ACSR.

MCM Maximum Cable Capacity

Cat. No.	Copper	Aluminum	ACSR	Communication Cable	Overall Length	Handle Color	Weight
63060	400 MCM (185 mm ²)	600 MCM (300 mm ²)	—	1-1/8" (28 mm)	10-1/4" (260 mm)	red	1.32 lbs.
63711	600 MCM (300 mm ²)	750 MCM (400 mm ²)	—	1-1/8" (28 mm)	11-1/2" (292 mm)	red	2.00 lbs.
63750	1000 MCM (500 mm ²) Frequent Use: 750 MCM (400 mm ²)	1000 MCM (500 mm ²) Frequent Use: 750 MCM (400 mm ²)	—	2-1/16" (52 mm)	12-1/8" (308 mm)	red	1.76 lbs.

All dimensions are in inches and (millimeters).

⚠ WARNING: Always wear approved eye protection.

⚠ WARNING: NOT insulated. Plastic-dipped or slip-on plastic handles are NOT intended for protection against electrical shock.



Cable Cutters

ACSR Ratcheting Cable Cutter

- Cutting inserts are easily replaced by simply removing 3 screws per blade.
- Capacity: 477 MCM ACSR
1-1/4" (32 mm) Ø CU-AL Stranded
1" (25 mm) Ø CU Solid
1/2" (13 mm) Ø Guy Strand (NOT FOR EHS)
- Tool can be locked when not in use.
- High-leverage ratcheting mechanism for easier cutting.
- Plastic covered handles with hand guards for comfort and firm grip.
- At a length of just under 14" tool can be carried in a tool pouch.
- Cleanly cuts 336 MCM Linnet ACSR and 2/0 triplex steel messenger cable (Cat. No. 63607).



63607



63800ACSR

MCM Maximum Cable Capacity

Cat. No.	ACSR	Stranded Aluminum & Copper	Solid Copper	Guy Strand	Length	Handle Color	Weight
63607	336 MCM (170 mm ²)	600 MCM (300 mm ²)	400 MCM (185 mm ²)	—	10-1/4" (260 mm)	yellow	1.50 lbs.
63800ACSR	477 MCM (273 mm ²)	1-1/4" (32 mm)	1" (25 mm)	1/2" (13 mm)	13-3/4" (349 mm)	red	3.20 lbs.
Replacement Cutting Inserts (with set of 6 screws)		Fits Klein Cat. No.					
63858							63800ACSR



All dimensions are in inches and (millimeters).

▲WARNING: Always wear approved eye protection.

▲WARNING: NOT insulated. Plastic-dipped or slip-on plastic handles are NOT intended for protection against electrical shock.

Cable Cutters

Ratcheting Cutter — Heavy-Duty



- Blade-advance knob for fast rotation of the blade to engage the cable or other material being cut, plus a quick-release mechanism allows for removal of the cable or rod before completion of the cut, if desired.
- Not designed for cutting EHS guy strand or reinforcement rod.

- Ratchet-action design provides maximum leverage with minimum effort for heavy-duty use.
- Cuts steel and ACSR.
- Forged, heat-treated, shear-type blades, plus plus 17" (432mm) long fiberglass handles with heavy duty grips for comfort and slip resistance.

63700

Cat. No.	Overall Length	Soft Cable-Cutting Maximum Capacity	Communications Cable-Cutting Maximum Capacity	Weight
63700	28" (711 mm)	2-1/4" (57 mm) diameter	1-1/4" (32 mm) dia. ACSR, ACAR 7/16" (11 mm) dia. common guy strand 5/8" (16 mm) dia. steel wire rope 1/2" (13 mm) dia. steel rod (C.R.S. SOFT) 750 MCM (1-3/8" dia.) (35 mm) copper or aluminum	14.00 lbs.

Bolt Cutters

Bolt Cutters



- All-purpose, center-cut jaws for soft, medium, and hard metals.
- Forged, alloy tool steel jaws are precision ground for sure, efficient cutting and long life.
- Lockplate reinforcement prevents jaw bolts from loosening or turning, keeps jaws in correct alignment.
- One adjustment realigns cutting edges.
- 3-point toggle joint multiplies 50 lbs. of hand pressure on handles to 4,000 pounds at cutting jaws.

63124

Cat. No.	Handle Type	Overall Length	Soft & Medium Cutting Max. Capacities*	Hard Material Cutting Max. Capacities**	Handle Color	Weight
Steel Handle						
63314	steel	14" (356 mm)	5/16" (8 mm)	3/16" (5 mm)	red	3.15 lbs.
63318	steel	18" (457 mm)	3/8" (10 mm)	1/4" (6 mm)	red	3.55 lbs.
63324	steel	24" (610 mm)	7/16" (11 mm)	5/16" (8 mm)	red	6.30 lbs.
63330	steel	30" (762 mm)	1/2" (13 mm)	3/8" (10 mm)	red	10.20 lbs.
63336	steel	36" (914 mm)	9/16" (14 mm)	7/16" (11 mm)	red	14.25 lbs.
63342	steel	42" (1067 mm)	11/16" (18 mm)	1/2" (13 mm)	red	19.20 lbs.
Fiberglass Handle						
63118	fiberglass	18-1/4" (464 mm)	3/8" (10 mm)	1/4" (6 mm)	red	3.65 lbs.
63124	fiberglass	24-1/2" (622 mm)	7/16" (11 mm)	5/16" (8 mm)	red	6.13 lbs.
63130	fiberglass	30-1/2" (775 mm)	1/2" (13 mm)	3/8" (10 mm)	red	9.50 lbs.
63136	fiberglass	36-1/2" (927 mm)	9/16" (14 mm)	7/16" (11 mm)	red	12.95 lbs.

Replacement Bolt Cutter Heads (complete)

Cat. No.	Fits Cat. No.	Weight
63214	63314	1.00 lbs.
63218	63118, 63318	1.25 lbs.
63224	63124, 63324	2.10 lbs.
63230	63130, 63330	3.40 lbs.
63242	63342	5.95 lbs.

Replacement Fiberglass Handle Sets

Cat. No.	Fits Cat. No.	Weight
63119	63118	2.15 lbs.
63125	63124	3.76 lbs.
63131	63130	5.56 lbs.
63137	63136	7.55 lbs.

▲WARNING: NOT for cutting cable.

* Up to Brinell 300, Rockwell C31.
** Up to Brinell 400, Rockwell C42.

All dimensions are in inches and (millimeters).

▲WARNING: Always wear approved eye protection.

▲WARNING: NOT insulated. Will NOT protect against electrical shock.



Bolt Cutters

Bolt Cutters — Heavy-Duty

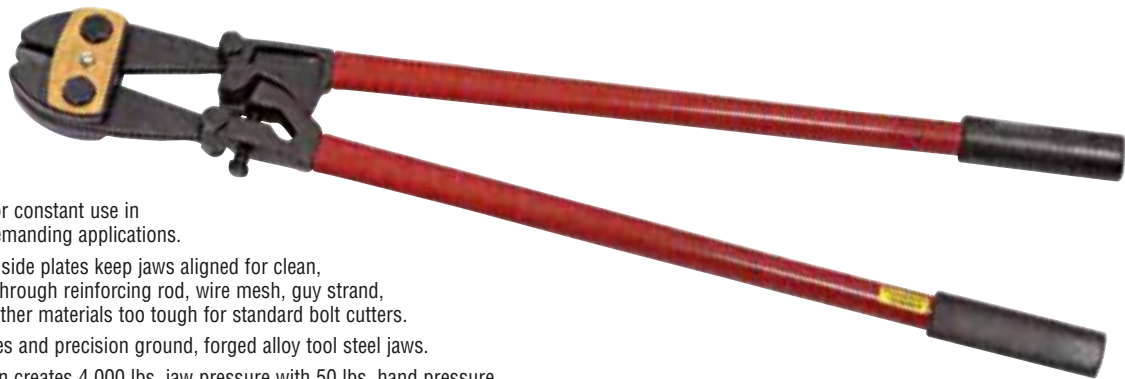

63536

- Designed for constant use in the most demanding applications.
- Heavy-duty side plates keep jaws aligned for clean, quick cuts through reinforcing rod, wire mesh, guy strand, and many other materials too tough for standard bolt cutters.
- Steel handles and precision ground, forged alloy tool steel jaws.
- Lever design creates 4,000 lbs. jaw pressure with 50 lbs. hand pressure.
- Handles have heavy vinyl grips with flat grip ends for 90° cuts.

Cat. No.	Overall Length	Soft & Medium Cutting Maximum Capacities*	Hard Material Cutting Maximum Capacities**	Weight
Steel Handle				
63524	24" (610 mm)	7/16" (11 mm)	5/16" (8 mm)	7.10 lbs.
63530	30" (762 mm)	1/2" (13 mm)	3/8" (10 mm)	11.65 lbs.
63536	36" (914 mm)	9/16" (14 mm)	7/16" (11 mm)	16.35 lbs.
63542	42" (1067 mm)	11/16" (18 mm)	1/2" (13 mm)	21.00 lbs.

* Up to Brinell 300, Rockwell C31.

** Up to Brinell 400, Rockwell C42.

Replacement Bolt Cutter Heads (complete)

Cat. No.	Fits Cat. No.	Weight
63636	63536	6.50 lbs.
63642	63542	8.70 lbs.

Cable Benders

- Forged, one-piece steel construction for exceptional durability and high strength to meet the most demanding job requirements.
- Head is angled 22° for ease in bending cable in tight, hard-to-access places.
- Corrosion-resistant, black-oxide finish with heavy-duty double-dipped plastic handle.
- Handle is contoured for a firm, comfortable grip.
- It is recommended that two benders be used for easier bends.



50400

Cat. No.	Overall Length	Tool Opening	Maximum Cable Capacity	Weight
50400	12" (305 mm)	7/8" (22 mm)	350 MCM	.90 lbs.
50402	14-1/2" (367 mm)	1-1/64" (26 mm)	500 MCM	1.55 lbs.

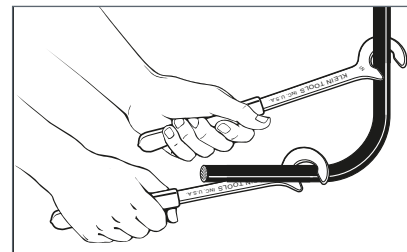

All dimensions are in inches and (millimeters).

▲WARNING: Always wear approved eye protection.

▲WARNING: NOT insulated. Will NOT protect against electrical shock.



Insulated Tools



Insulated Tools

Klein insulated tools combine excellent functionality along with reduction of risk of injury where a tool might make contact with an energized source with voltage up to 1000 volts.

For Professionals... Since 1857®

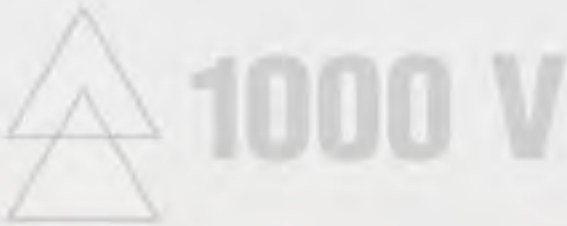

Introduction – Insulated Tools – Classic

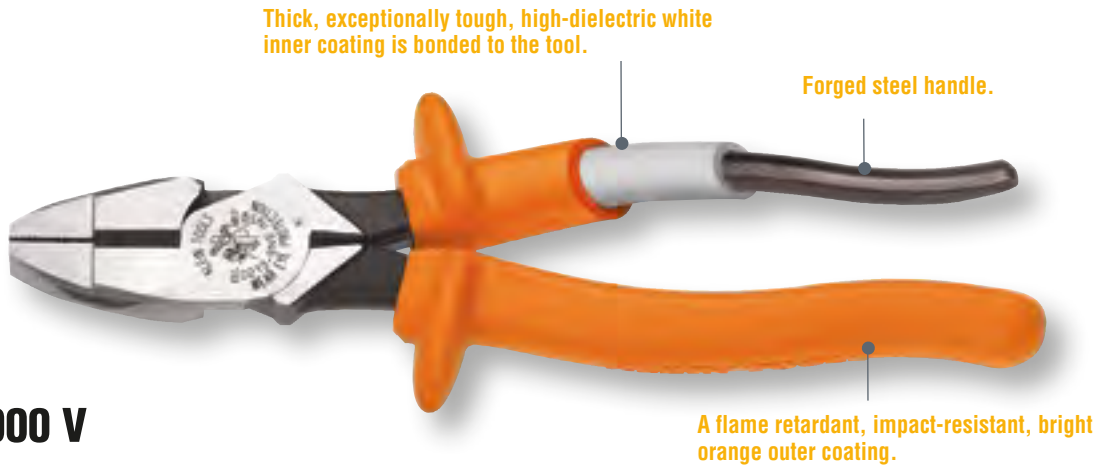

 **1000 V**

All Classic Klein insulated tools comply with ASTM F-1505 and IEC 60900-2004 standards for insulated tools and are clearly marked with the official international 1000-volt rating symbol. Not all tools with plastic coatings or plastic handles provide protection against electrical shock. The large, bright orange handles make the tool comfortable to use all day and easy to identify in the field. **Only use those tools that are marked with the official international 1000-volt rating symbol, as shown, if there is any chance that the tool will make contact with an energized source.**

Insulated Pliers – Classic

Features:



 **1000 V**

Individually tested to exceed the IEC 60900 and ASTM F1505 standards, for insulated tools, and clearly marked with the official 1000-volt rating symbol.



All dimensions are in inches and (millimeters).

⚠WARNING: Only use tools that are marked with the official international 1000-volt rating symbol shown below, if there is any chance that the tools will make contact with an energized source.

 **1000 V**

⚠WARNING: Wear approved eye protection. Always inspect your tools before use. Do not use if orange coating cracks, breaks or becomes damaged. Destroy tool if white layer shows through orange layer.

⚠WARNING: Do NOT use screwdrivers to pry or chisel.

⚠WARNING: Do NOT touch uninsulated portion of the tool or any conductive object when either might contact an energized source.

⚠WARNING: Whenever possible, always de-energize lines and equipment prior to working on or around them. Klein insulated tools are designed only to reduce the chance of injury where the tool may make contact with an energized source.

⚠WARNING: Because moisture, films, or other surface contaminants are conductive, Klein insulated tools must be kept clean, dry, and free of any surface contaminants.



Insulated Pliers – Classic



Insulated High-Leverage Side-Cutting Pliers

Additional Features:

- High-leverage design provides 46% greater cutting and gripping power than other plier designs.
- Streamlined design with sure-gripping, cross-hatched knurled jaws.



D213-9NE-INS

Cat. No.	Nose Type	Overall Length	Jaw Length	Jaw Width	Jaw Thickness	Knife Length
D213-9NE-INS	New England	9-5/8" (245 mm)	1-19/32" (41 mm)	1-5/16" (33 mm)	5/8" (16 mm)	25/32" (20 mm)
2000 Series* – Heavy-duty cutting knives						
D2000-9NE-INS	New England	9-5/8" (245 mm)	1-19/32" (41 mm)	1-5/16" (33 mm)	5/8" (16 mm)	25/32" (20 mm)

*Cuts ACSR, screws, nails, and most hardened wire. Features combination polished and black-oxide finish.

Insulated High-Leverage Side-Cutting Pliers – Connector Crimping

Additional Features:

- Crimping die behind hinge for superior leverage.



D213-9NECR-INS

Cat. No.	Nose Type	Overall Length	Jaw Length	Jaw Width	Jaw Thickness	Knife Length
D213-9NECR-INS	New England	9-5/8" (245 mm)	1-19/32" (41 mm)	1-5/16" (33 mm)	5/8" (16 mm)	25/32" (20 mm)

Insulated High-Leverage Universal Side-Cutting Pliers – Connector Crimping

Additional Features:

- Crimping die behind hinge for superior leverage crimping non-insulated connectors, lugs and terminals.
- Toothed pipe-grip for greater power.



12098-INS

Cat. No.	Nose Type	Overall Length	Jaw Length	Jaw Width	Jaw Thickness	Knife Length
12098-INS	Universal	8-7/8" (225 mm)	1-25/32" (45 mm)	1-1/32" (26 mm)	1/2" (13 mm)	3/4" (19 mm)

Insulated High-Leverage Diagonal-Cutting Pliers

Additional Features:

- High-leverage design. Rivet is closer to the cutting edge for 36% greater cutting power than other plier designs.



D228-8-INS

Cat. No.	Overall Length	Jaw Length	Jaw Width	Jaw Thickness	Cutting Knives
D228-8-INS	8-1/4" (210 mm)	13/16" (21 mm)	1-3/16" (30 mm)	7/16" (11 mm)	standard
2000 Series* – Heavy-duty cutting knives					
D2000-28-INS	8-1/4" (210 mm)	13/16" (21 mm)	1-3/16" (30 mm)	7/16" (11 mm)	standard

*Cuts ACSR, screws, nails, and most hardened wire. Features combination polished and black-oxide finish.

All dimensions are in inches and (millimeters).

⚠WARNING: Only use tools that are marked with the official international 1000-volt rating symbol shown below, if there is any chance that the tools will make contact with an energized source.



⚠WARNING: Wear approved eye protection. Always inspect your tools before use. Do not use if orange coating cracks, breaks or becomes damaged. Destroy tool if white layer shows through orange layer.

⚠WARNING: Do NOT use screwdrivers to pry or chisel.

⚠WARNING: Do NOT touch uninsulated portion of the tool or any conductive object when either might contact an energized source.

⚠WARNING: Whenever possible, always de-energize lines and equipment prior to working on or around them. Klein insulated tools are designed only to reduce the chance of injury where the tool may make contact with an energized source.

⚠WARNING: Because moisture, films, or other surface contaminants are conductive, Klein insulated tools must be kept clean, dry, and free of any surface contaminants.



Insulated Pliers – Classic

 1000 V

Insulated High-Leverage Diagonal-Cutting Pliers – Angled Head

Additional Features:

- Angled head for easier work in confined spaces.
- High-leverage design. Rivet is closer to the cutting edge for 36% greater cutting power than other plier designs.



D248-8-INS



Cat. No.	Overall Length	Jaw Length	Jaw Width	Jaw Thickness	Cutting Knives
D248-8-INS	8-1/4" (210 mm)	13/16" (21 mm)	1-3/16" (30 mm)	7/16" (11 mm)	standard
2000 Series* – Heavy-duty cutting knives					
D2000-48-INS	8-1/4" (210 mm)	13/16" (21 mm)	1-3/16" (30 mm)	7/16" (11 mm)	standard

*Cuts ACSR, screws, nails, and most hardened wire. Features combination polished and black-oxide finish.

Insulated Heavy-Duty Diagonal-Cutting Pliers – Tapered Nose

Additional Features:

- Heavy-duty tapered nose design.
- One-inch deep jaws easily reach into confined spaces.



D220-7-INS

Cat. No.	Overall Length	Jaw Length	Jaw Width	Jaw Thickness	Cutting Knives
D220-7-INS	7-7/8" (200 mm)	1" (25 mm)	31/32" (25 mm)	1/2" (13 mm)	standard

Insulated Heavy-Duty Long-Nose Pliers – Side-Cutting

Additional Features:

- Induction hardened cutting knives for long life.
- Heavier design for easier, more comfortable cutting.
- Extended handles provide added reach and leverage.
- Cat. No. D203-8N-INS has skinning hole for No. 12 AWG wire.



D203-8N-INS



Cat. No.	Overall Length	Jaw Length	Jaw Width	Jaw Thickness	Knife Length	Point Thickness
D203-8-INS	8-7/8" (225 mm)	2-5/16" (59 mm)	1" (25 mm)	1/2" (13 mm)	5/8" (16 mm)	1/8" (3 mm)
D203-8N-INS	8-7/8" (225 mm)	2-5/16" (59 mm)	1" (25 mm)	1/2" (13 mm)	5/8" (16 mm)	1/8" (3 mm)

All dimensions are in inches and (millimeters).

⚠WARNING: Only use tools that are marked with the official international 1000-volt rating symbol shown below, if there is any chance that the tools will make contact with an energized source.



⚠WARNING: Wear approved eye protection. Always inspect your tools before use. Do not use if orange coating cracks, breaks or becomes damaged. Destroy tool if white layer shows through orange layer.

⚠WARNING: Do NOT use screwdrivers to pry or chisel.

⚠WARNING: Do NOT touch uninsulated portion of the tool or any conductive object when either might contact an energized source.

⚠WARNING: Whenever possible, always de-energize lines and equipment prior to working on or around them. Klein insulated tools are designed only to reduce the chance of injury where the tool may make contact with an energized source.

⚠WARNING: Because moisture, films, or other surface contaminants are conductive, Klein insulated tools must be kept clean, dry, and free of any surface contaminants.



Insulated Pliers – Classic

 1000 V

Insulated Standard Long-Nose Pliers – Side-Cutting

Additional Features:

- Induction hardened cutting knives for long life.
- Knurled jaws for sure wrapping and looping.
- Curved handles provide greater tool control.

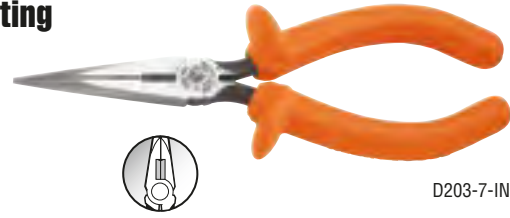

D203-7-INS

Cat. No.	Overall Length	Jaw Length	Jaw Width	Jaw Thickness	Knife Length	Point Thickness
D203-6-INS	6-7/8" (175 mm)	1-15/16" (49 mm)	11/16" (17 mm)	3/8" (10 mm)	1/2" (13 mm)	3/32" (2 mm)
D203-7-INS	7-3/8" (187 mm)	2-7/16" (62 mm)	11/16" (17 mm)	3/8" (10 mm)	1/2" (13 mm)	3/32" (2 mm)

Insulated Pump Pliers

Additional Features:

- Secure tongue and groove design for non-slip grip – even with heavy pressure.



D502-10-INS

Cat. No.	Overall Length	Max. Jaw Capacity
D502-10-INS	10-1/4" (260 mm)	1-3/4" (44 mm)

Insulated Crimping/Cutting Tool – Classic

Insulated Crimping/Cutting Tool

Additional Features:

- Tapered nose designed for working in confined spaces.
- Crimping dies marked for insulated and non-insulated solderless terminals and connectors.
- Accommodates wire from No. 10 to 22 AWG.
- Wire cutter in nose.



1005-INS

Cat. No.	Overall Length	Crimps
1005-INS	9-3/4" (248 mm)	10 to 22 AWG

Insulated Cable Cutter – Classic

Insulated High-Leverage Cable Cutter

Additional Features:

- Special, high-leverage design for exceptional cutting capability.
- Cable-gripping shear-type jaws.
- Precision, one-hand shearing action.
- Perfect for working in confined spaces.



63050-INS

Cat. No.	Overall Length	Cuts Up to
63050-INS	9-5/8" (245 mm)	4/0 aluminum, 2/0 soft copper, 100-pair 24 AWG communications cable

⚠ WARNING: Do NOT use to cut steel or ACSR.

All dimensions are in inches and (millimeters).

⚠ WARNING: Only use tools that are marked with the official international 1000-volt rating symbol shown below, if there is any chance that the tools will make contact with an energized source.



⚠ WARNING: Wear approved eye protection. Always inspect your tools before use. Do not use if orange coating cracks, breaks or becomes damaged. Destroy tool if white layer shows through orange layer.

⚠ WARNING: Do NOT use screwdrivers to pry or chisel.

⚠ WARNING: Do NOT touch uninsulated portion of the tool or any conductive object when either might contact an energized source.

⚠ WARNING: Whenever possible, always de-energize lines and equipment prior to working on or around them. Klein insulated tools are designed only to reduce the chance of injury where the tool may make contact with an energized source.

⚠ WARNING: Because moisture, films, or other surface contaminants are conductive, Klein insulated tools must be kept clean, dry, and free of any surface contaminants.



Insulated Stripper/Cutters – Classic

 1000 V

Insulated Wire Stripper/Cutter

Additional Features:

- Cuts, strips, loops and gauges wire.
- Spring-loaded for self-opening.
- Compact, lightweight wire-stripping, cutting tool.
- Narrow nose fits into tight places.
- Do not use for cutting steel wire or bolts.
- Hardened spring steel with precision-ground stripping holes for easy removal of insulation.



11049-INS

Cat. No.	Overall Length	Strips and Cuts	Handle Color
11045-INS	7" (178 mm)	10, 12, 14, 16, 18 solid AWG (4.0 mm ² , 2.5 mm ² , 1.5 mm ² , 1.0 mm ² , 0.75 mm ²)	orange
11049-INS	7" (178 mm)	8, 10, 12, 14, 16 stranded AWG (6.0 mm ² , 4.0 mm ² , 2.5 mm ² , 1.5 mm ² , 1.0 mm ²)	orange

Insulated Wire Stripper/Cutter **KLEIN-KURVE**

Additional Features:

- Cuts, strips, loops and gauges both solid and stranded wire.
- Spring-loaded for self-opening.
- Serrated nose for easy bending, shaping and pulling of wire.
- Cleanly shears 6-32 and 8-32 screws.
- Do not use for cutting steel wire.



SOLID **STRANDED**

11055-INS

Cat. No.	Overall Length	Strips and Cuts	Handle Color
11055-INS	8" (203 mm)	10, 12, 14, 16, 18 AWG solid 12, 14, 16, 18, 20 AWG stranded	orange

All dimensions are in inches and (millimeters).

⚠WARNING: Only use tools that are marked with the official international 1000-volt rating symbol shown below, if there is any chance that the tools will make contact with an energized source.



⚠WARNING: Wear approved eye protection. Always inspect your tools before use. Do not use if orange coating cracks, breaks or becomes damaged. Destroy tool if white layer shows through orange layer.

⚠WARNING: Do NOT use screwdrivers to pry or chisel.

⚠WARNING: Do NOT touch uninsulated portion of the tool or any conductive object when either might contact an energized source.

⚠WARNING: Whenever possible, always de-energize lines and equipment prior to working on or around them. Klein insulated tools are designed only to reduce the chance of injury where the tool may make contact with an energized source.

⚠WARNING: Because moisture, films, or other surface contaminants are conductive, Klein insulated tools must be kept clean, dry, and free of any surface contaminants.



Introduction – Electrician’s Insulated Pliers

NEW!

1000 V

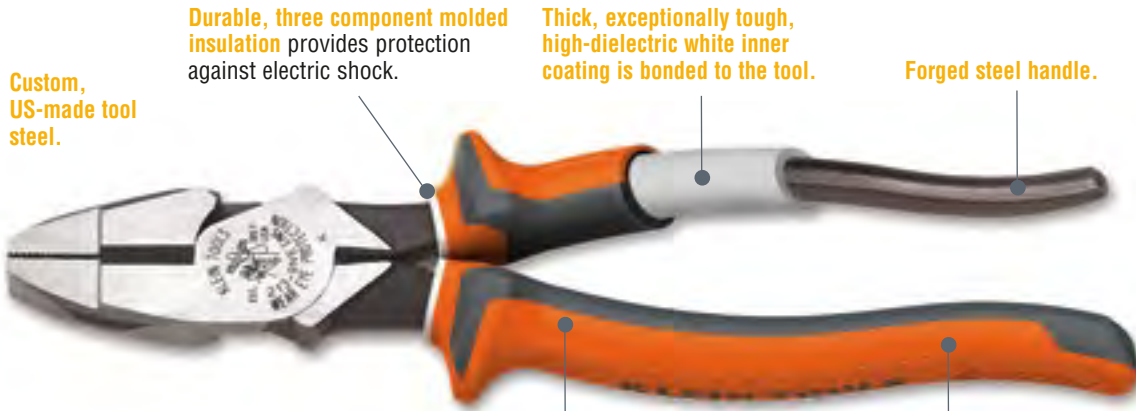

Custom, US-made tool steel.

Durable, three component molded insulation provides protection against electric shock.

Thick, exceptionally tough, high-dielectric white inner coating is bonded to the tool.

Forged steel handle.

Klein electrician's insulated tools meet or exceed IEC 60900: 2012, ASTM F1505, and VDE standards. They are clearly marked with the official 1000-volt rating symbol.

Multi-color, sleek design with small thumb guards for ease of handling and storage.

A flame retardant, impact-resistant, multi-color outer coating.



The Electrician's line of insulated tools provides a multi-color, sleeker design than the Classic Lineman's insulated tools. 1000V rated and individually tested to conform to ASTM F1505, IEC 60900. EINS tools have passed VDE third party testing certification to the IEC 60900 standard. This line of tools provides the everyday protection the electrician needs in a compact, lightweight design.

Catalog numbers for Klein electrician's insulated tools have the suffix "EINS" and are marked with the official international 1000-volt rating symbol. Not all tools with plastic coatings or plastic handles provide protection against electrical shock. **Only use those tools that are marked with the official international 1000-volt rating symbol, as shown, if there is any chance that the tool will make contact with an energized source.**



Electrician's Insulated Pliers

Electrician's Insulated High-Leverage Side-Cutting Pliers



213-9NE-EINS

Additional Features:

- High-leverage design provides 46% greater cutting and gripping power than other plier designs.
- Streamlined design with sure-gripping, cross-hatched knurled jaws.
- 2000 Series cuts ACSR, screws, nails and most hardened wires.

Cat. No.	Nose Type	Overall Length	Jaw Length	Jaw Width	Jaw Thickness	Knife Length
213-8NE-EINS	New England	8-13/16" (224 mm)	1-7/16" (37 mm)	1-7/64" (28 mm)	5/8" (16 mm)	3/4" (19 mm)
213-9NE-EINS	New England	9-5/8" (245 mm)	1-19/32" (41 mm)	1-5/16" (33 mm)	5/8" (16 mm)	25/32" (20 mm)
2000 Series* – Heavy-duty cutting knives						
2000-9NE-EINS	New England	9-5/8" (245 mm)	1-19/32" (41 mm)	1-5/16" (33 mm)	5/8" (16 mm)	25/32" (20 mm)

*Cuts ACSR, screws, nails, and most hardened wire. Features combination polished and black-oxide finish.

All dimensions are in inches and (millimeters).

▲WARNING: Only use tools that are marked with the official international 1000-volt rating symbol shown below, if there is any chance that the tools will make contact with an energized source.



▲WARNING: Wear approved eye protection. Always inspect your tools before use. Do not use if orange coating cracks, breaks or becomes damaged. Destroy tool if white layer shows through orange layer.

▲WARNING: Do NOT use screwdrivers to pry or chisel.

▲WARNING: Do NOT touch uninsulated portion of the tool or any conductive object when either might contact an energized source.

▲WARNING: Whenever possible, always de-energize lines and equipment prior to working on or around them. Klein insulated tools are designed only to reduce the chance of injury where the tool may make contact with an energized source.

▲WARNING: Because moisture, films, or other surface contaminants are conductive, Klein insulated tools must be kept clean, dry, and free of any surface contaminants.



Electrician's Insulated Pliers

NEW!

1000 V

Electrician's Insulated Combination Pliers

Additional Features:

- Crimping die behind hinge for superior leverage crimping non-insulated connectors, lugs and terminals.
- Toothed pipe-grip for greater power.



12098-EINS

Cat. No.	Nose Type	Overall Length	Jaw Length	Jaw Width	Jaw Thickness	Knife Length
12098-EINS	Universal	8-7/8" (225 mm)	1-25/32" (45 mm)	1-1/32" (26 mm)	1/2" (13 mm)	3/4" (19 mm)

Electrician's Insulated High-Leverage Diagonal Cutting Pliers

Additional Features:

- High-leverage design. Rivet is closer to the cutting edge for 36% greater cutting power than other plier designs.
- Cuts ACSR, screws, nails, and most hardened wire. Features combination polished and black-oxide finish.



2000-28-EINS

Cat. No.	Nose Type	Overall Length	Jaw Length	Jaw Width	Jaw Thickness	Knife Length
2000-28-EINS	tapered	8-1/4" (210 mm)	13/16" (21 mm)	1-3/16" (30 mm)	7/16" (11 mm)	standard

Electrician's Insulated High-Leverage Diagonal Cutting Pliers – Angled Head

Additional Features:

- Angled head for easier work in confined spaces.
- High-leverage design. Rivet is closer to the cutting edge for 36% greater cutting power than other plier designs.
- Cuts ACSR, screws, nails, and most hardened wire. Features combination polished and black-oxide finish.



2000-48-EINS

Cat. No.	Overall Length	Jaw Length	Jaw Width	Jaw Thickness	Cutting Knives
2000-48-EINS	8-1/4" (210 mm)	13/16" (21 mm)	1-3/16" (30 mm)	7/16" (11 mm)	standard

Electrician's Insulated Cable Cutter

Electrician's Insulated High-Leverage Cable Cutter

- High-leverage design for exceptional cutting capability.
- Cable-gripping shear-type jaws.
- Precision, one-hand shearing action.
- Perfect for working in confined spaces.

⚠WARNING: Do NOT use to cut steel or ACSR.



63050-EINS

Cat.No.	Overall Length	Cuts Up to
63050-EINS	9-5/8" (245 mm)	4/0 aluminum, 2/0 soft copper, 100-pair 24 AWG communications cable

All dimensions are in inches and (millimeters).

⚠WARNING: Only use tools that are marked with the official international 1000-volt rating symbol shown below, if there is any chance that the tools will make contact with an energized source.



⚠WARNING: Wear approved eye protection. Always inspect your tools before use. Do not use if orange coating cracks, breaks or becomes damaged. Destroy tool if white layer shows through orange layer.

⚠WARNING: Do NOT use screwdrivers to pry or chisel.

⚠WARNING: Do NOT touch uninsulated portion of the tool or any conductive object when either might contact an energized source.

⚠WARNING: Whenever possible, always de-energize lines and equipment prior to working on or around them. Klein insulated tools are designed only to reduce the chance of injury where the tool may make contact with an energized source.

⚠WARNING: Because moisture, films, or other surface contaminants are conductive, Klein insulated tools must be kept clean, dry, and free of any surface contaminants.

Insulated Tools



Electrician's Insulated Pliers

NEW!  1000 V

Electrician's Insulated Long-Nose Pliers – Side-Cutting

Additional Features:

- Induction hardened cutting knives for long life.
- Knurled jaws for sure wrapping and looping.
- Curved handles provide greater tool control.
- Extended handles provide added reach and leverage.



203-7-EINS



203-8N-EINS

Cat. No.	Overall Length	Jaw Length	Jaw Width	Jaw Thickness	Knife Length	Point Thickness
203-6-EINS	6-7/8" (175 mm)	1-15/16" (49 mm)	11/16" (17 mm)	3/8" (10 mm)	1/2" (13 mm)	3/32" (2 mm)
203-7-EINS	7-3/8" (187 mm)	2-7/16" (62 mm)	11/16" (17 mm)	3/8" (10 mm)	1/2" (13 mm)	3/32" (2 mm)
203-8-EINS	8-7/8" (225 mm)	2-5/16" (59 mm)	1" (25 mm)	1/2" (13 mm)	5/8" (16 mm)	1/8" (3 mm)

Electrician's Insulated Tongue & Groove Pliers

- Secure tongue and groove design for non-slip grip – even with heavy pressure.



502-10-EINS

Cat. No.	Overall Length	Max. Jaw Capacity
502-10-EINS	10-1/4" (260 mm)	1-3/4" (44 mm)

Electrician's Insulated Stripper/Cutters

Electrician's Insulated Solid & Stranded Stripper

Additional Features:

- Cuts, strips, loops and gauges both solid and stranded wire.
- Spring loaded for self-opening.
- Serrated nose for easy bending, shaping and pulling of wire.
- Cleanly shears 6-32 and 8-32 screws.
- Do not use for cutting steel wire.



SOLID
8-16 AWG

STRANDED
10-16 AWG

11054-EINS

Cat. No.	Overall Length	Strips and Cuts
11054-EINS	8" (203 mm)	8 – 16 AWG solid (8.4 mm ² – 1.3 mm ²) & 10 – 18 AWG stranded (5.3 mm ² – .82 mm ²)

All dimensions are in inches and (millimeters).

⚠WARNING: Only use tools that are marked with the official international 1000-volt rating symbol shown below, if there is any chance that the tools will make contact with an energized source.



⚠WARNING: Wear approved eye protection. Always inspect your tools before use. Do not use if orange coating cracks, breaks or becomes damaged. Destroy tool if white layer shows through orange layer.

⚠WARNING: Do NOT use screwdrivers to pry or chisel.

⚠WARNING: Do NOT touch uninsulated portion of the tool or any conductive object when either might contact an energized source.

⚠WARNING: Whenever possible, always de-energize lines and equipment prior to working on or around them. Klein insulated tools are designed only to reduce the chance of injury where the tool may make contact with an energized source.

⚠WARNING: Because moisture, films, or other surface contaminants are conductive, Klein insulated tools must be kept clean, dry, and free of any surface contaminants.



Insulated Screwdrivers and Nut Drivers

Features:



1000 V Klein insulated tools meet or exceed the IEC 60900 and ASTM F1505 standards, for insulated tools, and are clearly marked with the official 1000-volt rating symbol.



Hollow shafts make it possible to work on stacked circuit boards or other long bolt applications.

Cushion-Grip handles for greater torque and comfort.

Custom, US-made tool steel.

Durable, two layer, molded insulation.

Patented Tip-Ident® quickly identifies nut driver size.

Thick, exceptionally tough, high-dielectric white inner coating is bonded to the tool.

Bright orange outer coating is flame and impact resistant.



Insulated Screwdrivers

Insulated Phillips-Tip – Round-Shank Screwdrivers

Additional Features:

- Klein's profilated Phillips-tip provides a more consistent geometric symmetry than conventional Phillips-tip screwdrivers.
- Square-Recess tips are perfect for electrical, telephone and work in recessed holes and other tight spaces.



603-7-INS



661-7-INS

Cat. No.	Point Size	Shank Length	Overall Length
⊕ Insulated Phillips Tip			
633-4-INS	#1	4" (102 mm)	7-3/4" (197 mm)
603-4-INS	#2	4" (102 mm)	8-5/16" (212 mm)
603-7-INS	#2	7" (178 mm)	11-5/16" (288 mm)
633-7-INS	#3	7" (178 mm)	12-3/8" (315 mm)
● Insulated Cabinet Tip			
607-3-INS	3/32" (2.4 mm)	3" (76 mm)	6-3/4" (171 mm)
612-4-INS	1/8" (6 mm)	4" (102 mm)	7-3/4" (197 mm)
601-4-INS	3/16" (5 mm)	4" (102 mm)	7-3/4" (197 mm)
601-7-INS	3/16" (5 mm)	7" (178 mm)	10-3/4" (273 mm)
602-4-INS	1/4" (6 mm)	4" (102 mm)	8-5/16" (212 mm)
605-7-INS	1/4" (6 mm)	7" (178 mm)	11-5/16" (288 mm)
602-7-INS	5/16" (8 mm)	7" (178 mm)	12-3/8" (315 mm)
602-8-INS	3/8" (9.5 mm)	8" (204 mm)	13-3/8" (340 mm)

Cat. No.	Point Size	Shank Length	Overall Length
⊖ Insulated Square-Recess Tip			
661-4-INS	#1	4" (102 mm)	8-5/16" (212 mm)
661-7-INS	#1	7" (178 mm)	11-5/16" (288 mm) NEW!
662-4-INS	#2	4" (102 mm)	8-5/16" (212 mm)
662-7-INS	#2	7" (178 mm)	11-5/16" (288 mm) NEW!

All dimensions are in inches and (millimeters).

⚠WARNING: Only use tools that are marked with the official international 1000-volt rating symbol shown below, if there is any chance that the tools will make contact with an energized source.



⚠WARNING: Wear approved eye protection. Always inspect your tools before use. Do not use if orange coating cracks, breaks or becomes damaged. Destroy tool if white layer shows through orange layer.

⚠WARNING: Do NOT use screwdrivers to pry or chisel.

⚠WARNING: Do NOT touch uninsulated portion of the tool or any conductive object when either might contact an energized source.

⚠WARNING: Whenever possible, always de-energize lines and equipment prior to working on or around them. Klein insulated tools are designed only to reduce the chance of injury where the tool may make contact with an energized source.

⚠WARNING: Because moisture, films, or other surface contaminants are conductive, Klein insulated tools must be kept clean, dry, and free of any surface contaminants.



Insulated Screwdriver Sets



2-Piece Insulated 4" Screwdriver Set

Additional Features:

- Includes one 1/4" cabinet tip and one #2 Phillips tip.



33532-INS

Cat. No.	Set Contains
33532-INS	

Cat. No.	Description	Shank Tip Width	Shank Length	Overall Length
602-4-INS	round-shank, cabinet-tip	1/4" (6 mm)	4" (102 mm)	8-5/16" (211 mm)
603-4-INS	round-shank, profilated Phillips-tip	#2	4" (102 mm)	8-5/16" (211 mm)

Insulated Nut Drivers

6" Insulated Hollow-Shaft Nut Drivers

Additional Features:

- Slimmer molded insulation with increased durability.
- Hollow shafts make it possible to work on stacked circuit boards or other long bolt applications.



646-5/8-INS

Cat. No.	Color Code	Hex Size	Overall Length
646-3/16-INS	black	3/16"	9-3/4" (248 mm)
646-1/4-INS	red	1/4"	9-3/4" (248 mm)
646-5/16-INS	yellow	5/16"	9-3/4" (248 mm)
646-11/32-INS	green	11/32"	9-3/4" (248 mm)
646-3/8-INS	blue	3/8"	10-5/16" (262 mm)

Cat. No.	Color Code	Hex Size	Overall Length
646-7/16-INS	brown	7/16"	10-5/16" (262 mm)
646-1/2-INS	red	1/2"	11-3/8" (289 mm)
646-9/16-INS	orange	9/16"	11-3/8" (289 mm)
646-5/8-INS	yellow	5/8"	11-3/8" (289 mm)

Insulated Skinning Knife

Insulated Lineman's Skinning Knife

Additional Features:

- Molded measuring marks on back of handle to help measure stripping length of wire.
- Large molded handle for an easier, more comfortable grip.
- Tough, tempered steel blade provides maximum sharpness and durability to withstand frequent cable scoring.



1571-INS

Cat. No.	Blade Length	Handle Color	Overall Length
1571-INS	2 3/8" (60 mm)	orange	8-3/4" (223 mm)

All dimensions are in inches and (millimeters).

⚠WARNING: Only use tools that are marked with the official international 1000-volt rating symbol shown below, if there is any chance that the tools will make contact with an energized source.



⚠WARNING: Wear approved eye protection. Always inspect your tools before use. Do not use if orange coating cracks, breaks or becomes damaged. Destroy tool if white layer shows through orange layer.

⚠WARNING: Do NOT use screwdrivers to pry or chisel.

⚠WARNING: Do NOT touch uninsulated portion of the tool or any conductive object when either might contact an energized source.

⚠WARNING: Whenever possible, always de-energize lines and equipment prior to working on or around them. Klein insulated tools are designed only to reduce the chance of injury where the tool may make contact with an energized source.

⚠WARNING: Because moisture, films, or other surface contaminants are conductive, Klein insulated tools must be kept clean, dry, and free of any surface contaminants.



General-Purpose Insulated 22-Piece Tool Kit

- Case includes three pallets with custom-fitted pockets for each tool, piano-hinged cover has both a combination lock and two key-locked latches for security, storage space behind the pallets to keep important papers and accessory items.
- Inside dimensions:
7-3/4" W x 14-1/4" D x 8" H
(451 mm x 362 mm x 203 mm).
- Overall dimensions:
18-7/8" W x 15-3/8" D x 8-1/4" H
(479 mm x 391 mm x 210 mm).
- Replacement case (Cat. No. 33537) available.



33527

Cat. No.	Kit Contains	Weight
33527		24.30 lbs. (11 kg)

Cat. No.	Description
D2000-9NE-INS	insulated side-cutting pliers
12098-INS	insulated universal side-cutting pliers
D2000-28-INS	insulated diagonal-cutting pliers
D2000-48-INS	insulated diagonal-cutting pliers – angled head
D203-8N-INS	insulated heavy-duty long-nose pliers – side-cutting
D220-7-INS	insulated diagonal-cutting pliers – tapered nose
D203-6-INS	insulated long-nose pliers – side-cutting
D203-7-INS	insulated long-nose pliers – side-cutting
601-4-INS	insulated cabinet-tip – round-shank screwdriver (3/16" x 4")
601-7-INS	insulated cabinet-tip – round-shank screwdriver (3/16" x 7")
612-4-INS	insulated cabinet-tip – round-shank screwdriver (1/8" x 4")
602-4-INS	insulated cabinet-tip – round-shank screwdriver (1/4" x 4")
602-7-INS	insulated cabinet-tip – round-shank screwdriver (5/16" x 7")
602-8-INS	insulated cabinet-tip – round-shank screwdriver (3/8" x 8")
633-4-INS	insulated Phillips-tip – round-shank screwdriver (#1 x 4")
603-4-INS	insulated Phillips-tip – round-shank screwdriver (#2 x 4")
633-7-INS	insulated Phillips-tip – round-shank screwdriver (#3 x 7")
D502-10-INS	insulated pump pliers
11045-INS	insulated wire stripper/cutter
63050-INS	insulated high-leverage cable cutter
1571-INS	insulated lineman's skinning knife
1005-INS	insulated crimping/cutting tool
33537	extra-sturdy, bright-yellow case

All dimensions are in inches and (millimeters).

▲WARNING: Only use tools that are marked with the official international 1000-volt rating symbol shown below, if there is any chance that the tools will make contact with an energized source.



▲WARNING: Wear approved eye protection. Always inspect your tools before use. Do not use if orange coating cracks, breaks or becomes damaged. Destroy tool if white layer shows through orange layer.

▲WARNING: Do NOT use screwdrivers to pry or chisel.

▲WARNING: Do NOT touch uninsulated portion of the tool or any conductive object when either might contact an energized source.

▲WARNING: Whenever possible, always de-energize lines and equipment prior to working on or around them. Klein insulated tools are designed only to reduce the chance of injury where the tool may make contact with an energized source.

▲WARNING: Because moisture, films, or other surface contaminants are conductive, Klein insulated tools must be kept clean, dry, and free of any surface contaminants.



Utility Insulated 13-Piece Tool Kit

- The custom case includes two pallets with custom-fitted pockets for each tool, piano-hinged case cover has both a combination lock and two key-locked latches for security, storage space behind the pallets to keep important papers and accessory items.
- Inside dimensions: 17-3/4" W x 14-1/4" D x 8" H (451 mm x 362 mm x 203 mm).
- Overall dimensions: 18-7/8" W x 15-3/8" D x 8-1/4" H (479 mm x 391 mm x 210 mm).
- Replacement case (Cat. No. 33535) available.



33525

Cat. No.	Kit Contains	Weight
33525		20.05 lbs. (9 kg)

Cat. No.	Description
D2000-9NE-INS	insulated side-cutting pliers
D2000-28-INS	insulated diagonal-cutting pliers
D2000-48-INS	insulated diagonal-cutting pliers – angled head
D203-8-INS	insulated heavy-duty long-nose pliers – side-cutting
602-4-INS	insulated cabinet-tip – round-shank screwdriver (1/4" x 4")
602-7-INS	insulated cabinet-tip – round-shank screwdriver (5/16" x 7")
602-8-INS	insulated cabinet-tip – round-shank screwdriver (3/8" x 8")
633-4-INS	insulated Phillips-tip – round-shank screwdriver (#1 x 4")

Cat. No.	Description
603-4-INS	insulated Phillips-tip – round-shank screwdriver (#2 x 4")
633-7-INS	insulated Phillips-tip – round-shank screwdriver (#3 x 7")
63050-INS	insulated high-leverage cable cutter
D502-10-INS	insulated pump pliers
1571-INS	insulated lineman's skinning knife
33535	extra-sturdy, bright-yellow case

Utility Insulated 13-Piece Tool Kit

- The light, compact, soft roll-up carry case provides protective storage with custom-fitted pockets for each tool.
- Kit includes a padded, adjustable shoulder strap.
- Case dimensions:
Opened 24-1/2" x 24-1/2" (622 mm x 622 mm).
Closed 24-1/2" x 5-1/2" (622 mm x 140 mm).
- Replacement roll-up case (Cat. No. 33535SC) available.



33525SC

Cat. No.	Kit Contains	Weight
33525SC		9.75 lbs. (4.4 kg)

Cat. No.	Description
D2000-9NE-INS	insulated side-cutting pliers
D2000-28-INS	insulated diagonal-cutting pliers
D2000-48-INS	insulated diagonal-cutting pliers – angled head
D203-8-INS	insulated heavy-duty long-nose pliers – side-cutting
602-4-INS	insulated cabinet-tip – round-shank screwdriver (1/4" x 4")
602-7-INS	insulated cabinet-tip – round-shank screwdriver (5/16" x 7")
602-8-INS	insulated cabinet-tip – round-shank screwdriver (3/8" x 8")
633-4-INS	insulated Phillips-tip – round-shank screwdriver (#1 x 4")

Cat. No.	Description
603-4-INS	insulated Phillips-tip – round-shank screwdriver (#2 x 4")
633-7-INS	insulated Phillips-tip – round-shank screwdriver (#3 x 7")
63050-INS	insulated high-leverage cable cutter
D502-10-INS	insulated pump pliers
1571-INS	insulated lineman's skinning knife
33535SC	roll-up soft case with shoulder strap

All dimensions are in inches and (millimeters).

⚠WARNING: Only use tools that are marked with the official international 1000-volt rating symbol shown below, if there is any chance that the tools will make contact with an energized source.



⚠WARNING: Wear approved eye protection. Always inspect your tools before use. Do not use if orange coating cracks, breaks or becomes damaged. Destroy tool if white layer shows through orange layer.

⚠WARNING: Do NOT use screwdrivers to pry or chisel.

⚠WARNING: Do NOT touch uninsulated portion of the tool or any conductive object when either might contact an energized source.

⚠WARNING: Whenever possible, always de-energize lines and equipment prior to working on or around them. Klein insulated tools are designed only to reduce the chance of injury where the tool may make contact with an energized source.

⚠WARNING: Because moisture, films, or other surface contaminants are conductive, Klein insulated tools must be kept clean, dry, and free of any surface contaminants.



Insulated 8-Piece Tool Kits

- Highly durable, black nylon case features: coil-zipper closure, polypropylene handles, custom-fitted tool pockets.
- Overall case dimensions are:
15-1/2" W x 11" D x 2-1/2" H
(394 mm x 279 mm x 64 mm).
- Replacement case (Cat. No. 33536) available.



33529

See individual tool listings for more details.

Premium Insulated 8-Piece Tool Kit

Cat. No.	Kit Contains	Weight
33529		6.90 lbs. (3 kg)
Cat. No.	Description	
D2000-9NE-INS	insulated side-cutting pliers	
D2000-48-INS	insulated diagonal-cutting pliers	
D203-8N-INS	insulated heavy-duty long-nose pliers – side-cutting	
601-4-INS	insulated cabinet-tip – round-shank screwdriver (3/16" x 4")	
602-4-INS	insulated cabinet-tip – round-shank screwdriver (1/4" x 4")	
603-4-INS	insulated Phillips-tip – round-shank screwdriver (#2 x 4")	
63050-INS	insulated high-leverage cable cutter	
11055-INS	insulated wire stripper/cutter	
33536	heavy-duty polyester case	

Basic Insulated 8-Piece Tool Kit

Cat. No.	Kit Contains	Weight
33526		6.90 lbs. (3 kg)
Cat. No.	Description	
D213-9NE-INS	insulated side-cutting pliers	
D228-8-INS	insulated diagonal-cutting pliers	
D203-8N-INS	insulated heavy-duty long-nose pliers – side-cutting	
601-4-INS	insulated cabinet-tip – round-shank screwdriver (3/16" x 4")	
602-4-INS	insulated cabinet-tip – round-shank screwdriver (1/4" x 4")	
603-4-INS	insulated Phillips-tip – round-shank screwdriver (#2 x 4")	
63050-INS	insulated high-leverage cable cutter	
11045-INS	insulated wire stripper/cutter	
33536	heavy-duty polyester case	

All dimensions are in inches and (millimeters).

▲WARNING: Only use tools that are marked with the official international 1000-volt rating symbol shown below, if there is any chance that the tools will make contact with an energized source.



▲WARNING: Wear approved eye protection. Always inspect your tools before use. Do not use if orange coating cracks, breaks or becomes damaged. Destroy tool if white layer shows through orange layer.

▲WARNING: Do NOT use screwdrivers to pry or chisel.

▲WARNING: Do NOT touch uninsulated portion of the tool or any conductive object when either might contact an energized source.

▲WARNING: Whenever possible, always de-energize lines and equipment prior to working on or around them. Klein insulated tools are designed only to reduce the chance of injury where the tool may make contact with an energized source.

▲WARNING: Because moisture, films, or other surface contaminants are conductive, Klein insulated tools must be kept clean, dry, and free of any surface contaminants.



9-Piece Insulated Screwdriver Kit

- Nine-piece insulated screwdriver assortment with three sizes of each tip style: cabinet, keystone, and Phillips.
- Highly durable, black nylon case features: coil-zipper closure, polypropylene handles, custom-fitted tool pockets, extra pocket is provided for storage of papers or other items.
- Overall dimensions: 5-1/2" W x 11" D x 2-1/2" H (394 mm x 279 mm x 64 mm)
- Replacement case (Cat. No. 33538) available.

See individual tool listings for more details.

Cat. No.	Kit Contains	Weight
33528		5.40 lbs. (2.4 kg)

Cat. No.	Description
601-4-INS	insulated cabinet-tip – round-shank screwdriver (3/16" x 4")
601-7-INS	insulated cabinet-tip – round-shank screwdriver (3/16" x 7")
612-4-INS	insulated cabinet-tip – round-shank screwdriver (1/8" x 4")
602-4-INS	insulated cabinet-tip – round-shank screwdriver (1/4" x 4")
602-7-INS	insulated cabinet-tip – round-shank screwdriver (5/16" x 7")
602-8-INS	insulated cabinet-tip – round-shank screwdriver (3/8" x 8")
633-4-INS	insulated Phillips-tip – round-shank screwdriver (#1 x 4")
603-4-INS	insulated Phillips-tip – round-shank screwdriver (#2 x 4")
633-7-INS	insulated Phillips-tip – round-shank screwdriver (#3 x 7")
33538	heavy-duty polyester case



33528

Cushion-Grip Insulated 9-Piece Nut Driver Kits

- Nine-piece insulated nut driver assortment of popular sizes.
- Individually tested to exceed standards.
- Two layers of insulation provide protection against electric shock.
- Highly durable, black nylon case features: oil-zipper closure, polypropylene handles, custom-fitted tool pockets, extra pocket is provided for storage of papers or other items.
- Overall case dimensions are: 15" W x 12-3/4" L x 3-1/2" D (381 mm x 324 mm x 89 mm).
- Replacement case available Cat. No. 33534.

See individual tool listings for more details.

Cat. No.	Kit Contains	Weight
33524		6.00 lbs. (2.7 kg)

Cat. No.	Description
646-3/16-INS	insulated 3/16" hollow shaft nut driver, 6" shaft
646-1/4-INS	insulated 1/4" hollow shaft nut driver, 6" shaft
646-5/16-INS	insulated 5/16" hollow shaft nut driver, 6" shaft
646-11/32-INS	insulated 11/32" hollow shaft nut driver, 6" shaft
646-3/8-INS	insulated 3/8" hollow shaft nut driver, 6" shaft
646-7/16-INS	insulated 7/16" hollow shaft nut driver, 6" shaft
646-1/2-INS	insulated 1/2" hollow shaft nut driver, 6" shaft
646-9/16-INS	insulated 9/16" hollow shaft nut driver, 6" shaft
646-5/8-INS	insulated 5/8" hollow shaft nut driver, 6" shaft
33534	Custom heavy-duty Cordura® case



33524

Cordura® is a registered trademark of INVISTA for durable fabrics.

All dimensions are in inches and (millimeters).

⚠WARNING: Only use tools that are marked with the official international 1000-volt rating symbol shown below, if there is any chance that the tools will make contact with an energized source.



⚠WARNING: Wear approved eye protection. Always inspect your tools before use. Do not use if orange coating cracks, breaks or becomes damaged. Destroy tool if white layer shows through orange layer.

⚠WARNING: Do NOT use screwdrivers to pry or chisel.

⚠WARNING: Do NOT touch uninsulated portion of the tool or any conductive object when either might contact an energized source.

⚠WARNING: Whenever possible, always de-energize lines and equipment prior to working on or around them. Klein insulated tools are designed only to reduce the chance of injury where the tool may make contact with an energized source.

⚠WARNING: Because moisture, films, or other surface contaminants are conductive, Klein insulated tools must be kept clean, dry, and free of any surface contaminants.

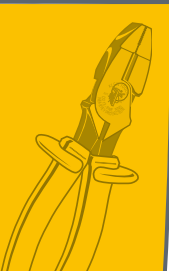

Screwdrivers, Nut Drivers & Accessories

Offering a variety of tip types, hex sizes, shaft lengths, and handle designs, Klein has the screwdrivers and nut drivers professionals demand to get the job done with comfort and ease of use.

FOR Professionals... Since 1857®



Screwdrivers, Nut Drivers & Accessories

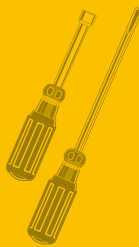

Introduction – Screwdrivers, Nut Drivers & Accessories

Klein screwdrivers give professionals extra-quality features that have made the Klein name famous for hand tools – features that assure greater convenience, comfort and efficiency in use, plus exceptional strength and durability.

All Klein drivers are made of the highest quality tempered steel, carefully heat-treated for maximum strength. Shafts have integral flanges that provide an extra-strong, torque-proof anchor in the handle. Strong, durable black tips are forged and precision ground with square edges to fit screw openings securely. They resist slippage and provide positive turning action.

Cushion-Grip screwdrivers feature super-comfortable, sure-grip handles on top-quality blades for the professional. All Klein screwdrivers meet or exceed applicable ANSI and MIL specifications.

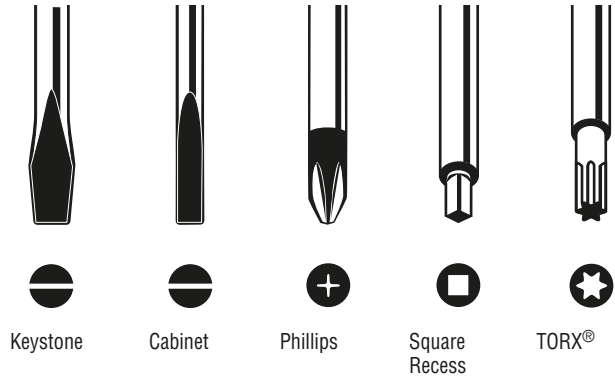

Using screwdrivers

The size of the screw and the type of opening it has determines which driver to use. Here are a few tips on how to use a driver that can be of benefit, because screwdrivers are the most often misused and abused hand tools of all.

- 1. Never use a driver to do another tool's job.** Using a driver as a pry bar, scraper, or a chisel can ruin the tool, spoil the work and cause injury.
- 2. Never push a driver beyond its capacity.** Make a pilot hole for the screw for easier driving. Use square-shank drivers for heavy work.
- 3. Never expose a driver to excessive heat.** Direct flame can draw the temper from the metal, weakening and possibly warping it, making it unsafe and inefficient to use.

4. Never use a driver at an angle to the screw. Always keep the shank perpendicular to the screw head. Driving at an angle or using a point that is too small can spoil the screw or slip and damage the work.

5. Never depend on a driver's handle or covered blade to insulate you from electricity. Plastic and Cushion-Grip handles are intended only to provide a firm, comfortable grip. Insulated blades are intended only as a protective measure against shorting out components. Only use insulated tools that are marked with the official international 1000-volt rating symbol if there is any chance that the tool will make contact with an energized source.

6. Discard damaged or worn drivers.

TORX® is a registered trademark of Acument Intellectual Properties, LLC.

Cushion-Grip Screwdriver Sets

Features:

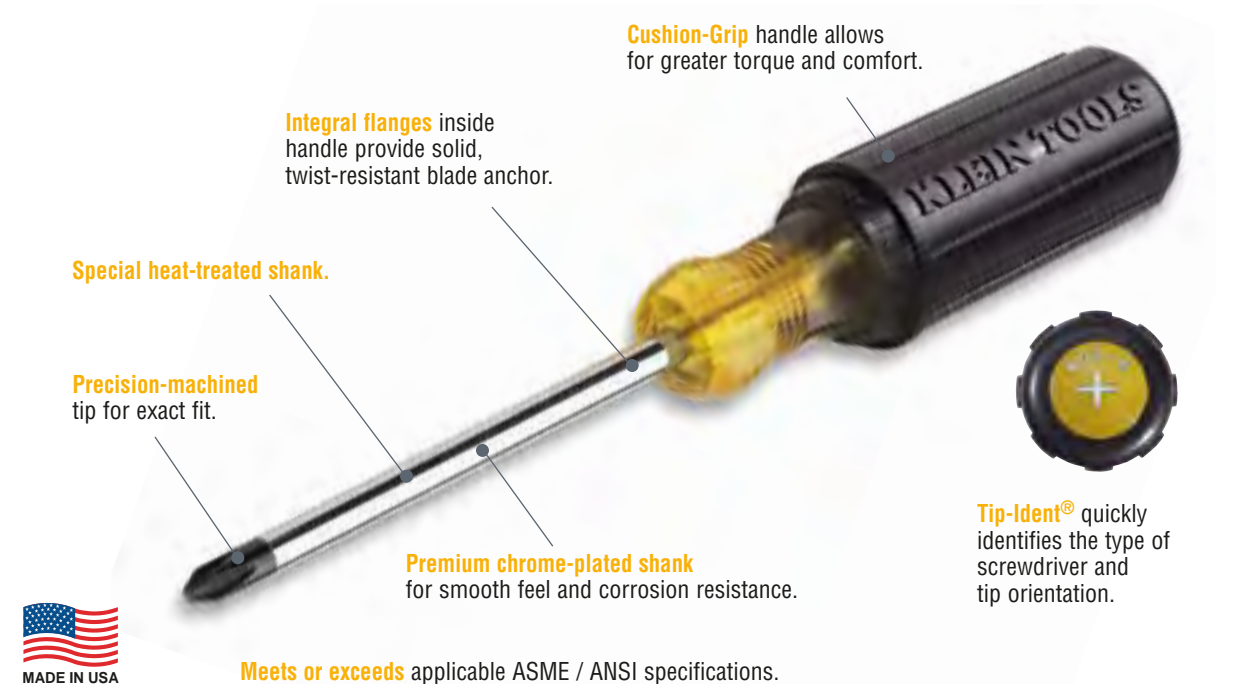

All dimensions are in inches and (millimeters).

⚠ WARNING: NOT insulated. Will NOT protect against electrical shock.

⚠ WARNING: Always wear approved eye protection.

⚠ WARNING: Do NOT use to pry or chisel.



Cushion-Grip Screwdriver Sets

8-Piece Cushion-Grip Screwdriver Set

Additional Features:

- General purpose selection of the most frequently used screwdrivers.
- Includes one cabinet-tip, three keystone-tip, four Phillips-tip styles.

Cat. No.	Set Contains	Weight (lbs.)	
85078		1.65	
Cat. No.	Description	Shank Length	Overall Length
600-1	round-shank, keystone-tip	1-1/2" (38 mm)	3-7/16" (87 mm)
601-3	round-shank, #2 Phillips-tip	1-1/2" (38 mm)	3-7/16" (87 mm)
600-4	square-shank, keystone-tip*	4" (102 mm)	8-11/32" (212 mm)
602-6	round-shank, keystone-tip*	6" (152 mm)	10-15/16" (278 mm)
603-1	round-shank, #2 Phillips-tip	1-1/2" (38 mm)	3-7/16" (87 mm)
603-3	round-shank, #1 Phillips-tip	3" (76 mm)	6-3/4" (171 mm)
603-4	round-shank, #2 Phillips-tip	4" (102 mm)	8-5/16" (211 mm)
603-6	round-shank, #3 Phillips-tip	6" (152 mm)	11" (279 mm)

* Heavy-duty models



85078

7-Piece Cushion-Grip Screwdriver Set

Additional Features:

- General-purpose selection of the most frequently used screwdrivers.
- Includes three cabinet-tip, two Phillips-tip and two keystone-tip styles.

Cat. No.	Set Contains	Weight (lbs.)	
85076		1.50	
Cat. No.	Description	Blade Length	Overall Length
600-4	square-shank, keystone-tip*	4" (102 mm)	8-11/32" (212 mm)
602-6	round-shank, keystone-tip*	6" (152 mm)	10-15/16" (278 mm)
601-3	round-shank, cabinet-tip	3" (76 mm)	6-3/4" (171 mm)
601-6	round-shank, cabinet-tip	6" (152 mm)	9-3/4" (248 mm)
605-4	round-shank, cabinet-tip*	4" (102 mm)	8-11/32" (212 mm)
603-3	round-shank, #1 Phillips-tip	3" (76 mm)	6-3/4" (171 mm)
603-4	round-shank, #2 Phillips-tip	4" (102 mm)	8-5/16" (211 mm)

* Heavy-duty models



85076

7-Piece Multiple-Application Screwdriver Set

Additional Features:

- Specialty set for a wide variety of applications.
- Includes two cabinet-tip, one Phillips-tip, two keystone-tip, one rotary and one screw-holding screwdriver.

Cat. No.	Set Contains	Weight (lbs.)	
85077		1.65	
Cat. No.	Description	Blade Length	Overall Length
600-4	square-shank, keystone-tip*	4" (102 mm)	8-11/32" (212 mm)
601-6	round-shank, cabinet-tip	6" (152 mm)	9-3/4" (248 mm)
602-6	round-shank, keystone-tip*	6" (152 mm)	10-15/16" (278 mm)
603-4	round-shank, #2 Phillips-tip	4" (102 mm)	8-5/16" (211 mm)
605-6	round-shank, cabinet-tip*	6" (152 mm)	10-11/32" (263 mm)
670-6	cabinet-tip rotary screwdriver	6" (152 mm)	9-3/4" (248 mm)
K36	slotted screw-holding screwdriver	6" (152 mm)	9-3/4" (248 mm)

* Heavy-duty model



85077

All dimensions are in inches and (millimeters).

WARNING: Always wear approved eye protection.

WARNING: NOT insulated. Will NOT protect against electrical shock.

WARNING: Do NOT use to pry or chisel.

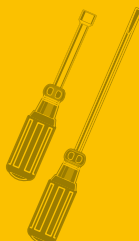

Cushion-Grip Screwdriver Sets

6-Piece Cushion-Grip Screwdriver Set

Additional Features:

- General-purpose selection of the most frequently used screwdrivers.
- Includes one cabinet-tip, two keystone-tip and three Phillips-tip styles.

Cat. No.	Set Contains	Weight (lbs.)
85074		1.50

Cat. No.	Description	Blade Length	Overall Length
601-3	round-shank, cabinet-tip	3" (76 mm)	6-3/4" (171 mm)
600-4	square-shank, keystone-tip*	4" (102 mm)	8-11/32" (212 mm)
600-6	square-shank, keystone-tip*	6" (152 mm)	10-15/16" (278 mm)
603-3	round-shank, #1 Phillips-tip	3" (76 mm)	6-3/4" (171 mm)
603-4	round-shank, #2 Phillips-tip	4" (102 mm)	8-5/16" (211 mm)
603-6	round-shank, #3 Phillips-tip	6" (152 mm)	11" (279 mm)

* Heavy-duty models



85074

5-Piece Cushion-Grip Screwdriver Set

Additional Features:

- General-purpose selection of the most frequently used screwdrivers.
- Includes two cabinet-tip, one Phillips-tip and two keystone-tip screwdrivers.

Cat. No.	Set Contains	Weight (lbs.)
85075		1.30

Cat. No.	Description	Blade Length	Overall Length
600-4	square-shank, keystone-tip*	4" (102 mm)	8-11/32" (212 mm)
601-6	round-shank, cabinet-tip	6" (152 mm)	9-3/4" (248 mm)
602-6	round-shank, keystone-tip*	6" (152 mm)	10-15/16" (278 mm)
603-4	round-shank, #2 Phillips-tip	4" (102 mm)	8-5/16" (211 mm)
605-6	round-shank, cabinet-tip*	6" (152 mm)	10-11/32" (263 mm)

* Heavy-duty models



85075

4-Piece Cushion-Grip Screwdriver Set

Additional Features:

- The screwdrivers Professionals carry most often.
- Includes one Phillips-tip, two keystone-tip, one cabinet-tip screwdrivers.

Cat. No.	Set Contains	Weight (lbs.)
85105		1.50

Cat. No.	Description	Blade Length	Overall Length
603-4	round-shank, #2 Phillips-tip	4" (102 mm)	8-5/16" (211 mm)
600-4	square-shank, keystone-tip*	4" (102 mm)	8-11/32" (212 mm)
601-6	round-shank, cabinet-tip	6" (152 mm)	9-3/4" (248 mm)
600-6	square-shank, keystone-tip*	6" (152 mm)	10-15/16" (278 mm)

* Heavy-duty models



85105

All dimensions are in inches and (millimeters).

⚠ WARNING: NOT insulated. Will NOT protect against electrical shock.

⚠ WARNING: Always wear approved eye protection.

⚠ WARNING: Do NOT use to pry or chisel.

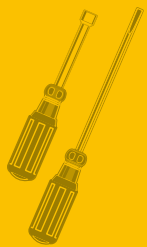

Cushion-Grip Screwdriver Sets

Electronics Screwdrivers

- Rotating cap for optimum and precise control.
- Klein Cushion-Grip handle for maximum comfort when working on small equipment.
- Professional custom carrying case included in set.
- Screwdrivers sold individually and in set (Cat. No. 85614).

Cat. No.	Set Contains	Weight	
85614		.80 lbs. (0.36 kg.)	
Cat. No.	Description	Blade Length	Overall Length
614-2	1/16" Slotted	2" (51 mm)	5-1/2" (140 mm)
613-3	#0 Phillips	3" (76 mm)	6-1/2" (165 mm)
614-3	3/32" Slotted	3" (76 mm)	6-1/2" (165 mm)
614-4	1/8" Slotted	4" (102 mm)	7-1/2" (191 mm)
614-6	1/8" Slotted	6" (152 mm)	9-1/2" (241 mm)



85614

4-Piece Miniature Cushion-Grip Screwdriver Set

Additional Feature:

- Precision tips for exact fit and rigorous applications.

Cat. No.	Set Contains	Weight (lbs.)		
85484		.14		
Cat. No.	Tip Type	Tip Size	Shank Length	Overall Length
604-3	Phillips-tip	#0	3" (76 mm)	5-3/4" (146 mm)
606-2	keystone-tip	1/16" (1.6 mm)	2" (51 mm)	4-3/4" (121 mm)
607-3	cabinet-tip	3/32" (2.4 mm)	3" (76 mm)	5-3/4" (146 mm)
608-3	cabinet-tip	1/8" (3.2 mm)	3" (76 mm)	5-3/4" (146 mm)



85484

5-Piece TORX® Cushion-Grip Screwdriver Set

Additional Features:

- TORX® drive systems transmit more torque to the work and reduce slippage, saving fasteners.
- Chrome-plated shafts resist corrosion.

Cat. No.	Set Contains	Weight (lbs.)		
19555		1.20		
Cat. No.	TORX® Size	Color Code	Shank Length	Overall Length
19542	T15	yellow	4" (102 mm)	7-3/4" (197 mm)
19543	T20	green	4" (102 mm)	7-3/4" (197 mm)
19544	T25	blue	4" (102 mm)	7-3/4" (197 mm)
19545	T27	brown	4" (102 mm)	8-5/16" (211 mm)
19546	T30	red	4" (102 mm)	8-5/16" (211 mm)



19555

TORX® is a registered trademark of Acument Intellectual Properties, LLC.

All dimensions are in inches and (millimeters).

▲WARNING: Always wear approved eye protection.

▲WARNING: NOT insulated. Will NOT protect against electrical shock.

▲WARNING: Do NOT use to pry or chisel.

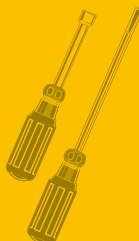

Cushion-Grip Screwdriver Sets

2-Piece 10" Long Blade Screwdriver Set

Additional Features:

- Phillips-tip is precision-machined to provide a more consistent geometric symmetry than conventional Phillips-tip screwdrivers.
- Precision-ground narrow cabinet-tip permits blade access where space is limited.
- Ideal for hard-to-reach places where added length is necessary.
- Includes one Phillips-tip and one cabinet-tip.

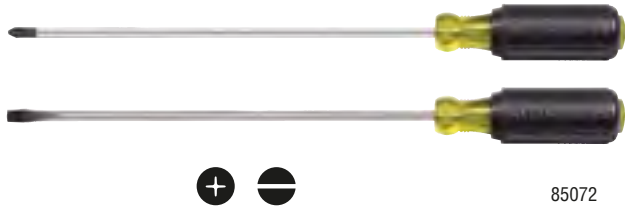

85072

Cat. No.	Set Contains	Weight (lbs.)
85072		.70

Cat. No.	Description	Shank Tip Size	Shank Length	Overall Length
603-10	round-shank, profilated Phillips-tip	#2	10" (254 mm)	14-5/16" (363 mm)
605-10	round-shank, cabinet-tip	1/4" (6 mm)	10" (254 mm)	14-5/16" (363 mm)

4-Piece Square Recess Cushion-Grip Screwdriver Set

Additional Features:

- Round shank with square-recess tip.
- Chrome-plated shank for corrosion resistance.
- Works on most combination head receptacle, switch and panel screws.



85664

Cat. No.	Set Contains	Weight (lbs.)
85664		1.50

Cat. No.	Point Size	Color Code	Shank Length	Overall Length
660	#0	yellow	4" (102 mm)	7-3/4" (197 mm)
661	#1	green	4" (102 mm)	7-3/4" (197 mm)
662	#2	red	4" (102 mm)	8-5/16" (211 mm)
663	#3	black	4" (102 mm)	8-5/16" (211 mm)

2-Piece Stubby Cushion-Grip Screwdriver Set

Additional Feature:

- Double wings inside handle provide solid, twist-resistant blade anchor.

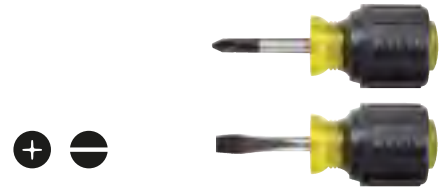

85071

Cat. No.	Set Contains	Weight (lbs.)
85071		.30

Cat. No.	Description	Shank Length	Overall Length
600-1	round-shank, keystone-tip	1-1/2" (38 mm)	3-7/16" (87 mm)
603-1	round-shank, #2 Phillips-tip	1-1/2" (38 mm)	3-7/16" (87 mm)

Stubby Square-Recess Tip Cushion-Grip Screwdrivers

Additional Features:

- Double wings inside handle provide solid, twist-resistant blade anchor.
- Works on most combination head receptacle and switch screws.
- Color-coded handle ends for quick and easy identification.

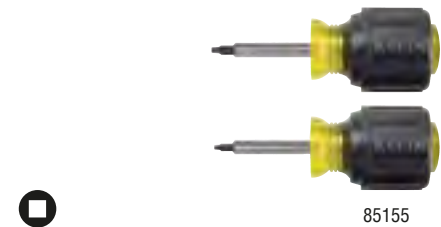

85155

Cat. No.	Set Contains	Weight (lbs.)
85155		.30

Cat. No.	Description	Shank Length	Overall Length
668	round-shank, #1 square-recess tip	1-1/2" (38 mm)	3-7/16" (87 mm)
669	round-shank, #2 square-recess tip	1-1/2" (38 mm)	3-7/16" (87 mm)

All dimensions are in inches and (millimeters).

⚠WARNING: NOT insulated. Will NOT protect against electrical shock.

⚠WARNING: Always wear approved eye protection.

⚠WARNING: Do NOT use to pry or chisel.

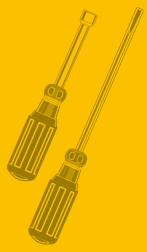

Cushion-Grip Screwdrivers

Keystone-Tip Screwdrivers – Heavy-Duty Square-Shanks

Additional Features:

- Heavy-duty square shank for wrench-assisted turning.
- Bolster reinforces shank for hard use.
- Designed for the most demanding uses.



Cat. No.	Tip Size	Shank Length	Overall Length	Weight (lbs.)
600-4	1/4" (6 mm)	4" (102 mm)	8-11/32" (212 mm)	.25
600-6	5/16" (8 mm)	6" (152 mm)	10-15/16" (278 mm)	.40

Cat. No.	Tip Size	Shank Length	Overall Length	Weight (lbs.)
600-8	3/8" (10 mm)	8" (203 mm)	13-7/16" (341 mm)	.65
600-12	1/2" (13 mm)	12" (305 mm)	17-7/16" (443 mm)	.80

Keystone-Tip Screwdrivers – Heavy-Duty Round-Shanks

Additional Features:

- Built to handle the tough jobs with ease.
- Hex bolster reinforces shank for hard use and allows wrench assisted turning.



Cat. No.	Tip Size	Shank Length	Overall Length	Weight (lbs.)
600-1*	1/4" (6 mm)	1-1/2" (38 mm)	3-7/16" (87 mm)	.10
602-3	7/32" (6 mm)	3" (76 mm)	6-3/4" (171 mm)	.15
602-4	1/4" (6 mm)	4" (102 mm)	8-11/32" (212 mm)	.25
602-6	5/16" (8 mm)	6" (152 mm)	10-15/16" (278 mm)	.35

Cat. No.	Tip Size	Shank Length	Overall Length	Weight (lbs.)
602-8	3/8" (10 mm)	8" (203 mm)	13-7/16" (341 mm)	.55
602-10	3/8" (10 mm)	10" (254 mm)	15-7/16" (392 mm)	.60
602-12	3/8" (10 mm)	12" (305 mm)	17-7/16" (443 mm)	.65

* Bolster not available on Cat. No. 600-1
Refer to the Insulated Tools section for insulated screwdrivers.

Cabinet-Tip Screwdrivers – Round-Shanks

Additional Feature:

- Narrow cabinet-tip permits blade access where space is limited.



Cat. No.	Tip Size	Shank Length	Overall Length	Weight (lbs.)
601-3	3/16" (5 mm)	3" (76 mm)	6-3/4" (171 mm)	.10
601-4	3/16" (5 mm)	4" (102 mm)	7-3/4" (197 mm)	.15
601-6	3/16" (5 mm)	6" (152 mm)	9-3/4" (248 mm)	.15
601-8	3/16" (5 mm)	8" (203 mm)	11-3/4" (298 mm)	.20
601-10	3/16" (5 mm)	10" (254 mm)	13-3/4" (349 mm)	.20

Cat. No.	Tip Size	Shank Length	Overall Length	Weight (lbs.)
Heavy-Duty Shanks				
605-4	1/4" (6 mm)	4" (102 mm)	8-11/32" (212 mm)	.25
605-6	1/4" (6 mm)	6" (152 mm)	10-11/32" (263 mm)	.30
605-8	1/4" (6 mm)	8" (203 mm)	12-11/32" (314 mm)	.30
605-10	1/4" (6 mm)	10" (254 mm)	14-11/32" (365 mm)	.35

Refer to the insulated section for insulated screwdrivers.

Profiled Phillips-Tip Screwdrivers – Round-Shanks

Additional Features:

- Tips are precision-machined to provide a more consistent geometric symmetry than conventional Phillips-tip screwdrivers.
- Provides accurate fit and torque without slippage.



Cat. No.	Tip Size	Shank Length	Overall Length	Weight (lbs.)
603-1	#2	1-1/2" (38 mm)	3-7/16" (87 mm)	.10
603-3	#1	3" (76 mm)	6-3/4" (171 mm)	.15
603-4	#2	4" (102 mm)	8-5/16" (211 mm)	.25
603-6	#3	6" (152 mm)	11" (279 mm)	.35

Cat. No.	Tip Size	Shank Length	Overall Length	Weight (lbs.)
603-7	#2	7" (178 mm)	11-5/16" (287 mm)	.30
603-10	#2	10" (254 mm)	14-5/16" (364 mm)	.35

Refer to the insulated section for insulated screwdrivers.

All dimensions are in inches and (millimeters).

▲WARNING: Always wear approved eye protection.

▲WARNING: NOT insulated. Will NOT protect against electrical shock.

▲WARNING: Do NOT use to pry or chisel.

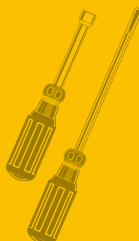

Cushion-Grip Screwdrivers

Electronics Screwdrivers

Additional Feature:

- Rotating cap for optimum and precise control.



614-6

Cat No.	Tip Type	Tip Size	Shank Length	Overall Length
614-2	Slotted	1/16"	2" (51 mm)	5-1/2" (140 mm)
613-3	Phillips	#0	3" (76 mm)	6-1/2" (165 mm)
614-3	Slotted	3/32"	3" (76 mm)	6-1/2" (165 mm)
614-4	Slotted	1/8"	4" (102 mm)	7-1/2" (191 mm)
614-6	Slotted	1/8"	6" (152 mm)	9-1/2" (241 mm)

Miniature Screwdrivers

Additional Feature:

- Precision tip for exact fit and rigorous applications.



608-6

Cat No.	Tip Type	Tip Size	Shank Length	Overall Length	Weight (lbs.)
604-3	Phillips-tip	#0	3" (76 mm)	5-3/4" (146 mm)	.04
606-2	keystone-tip	1/16" (1.6 mm)	2" (51 mm)	4-3/4" (121 mm)	.03
607-2	cabinet-tip	3/32" (2.4 mm)	2" (51 mm)	4-3/4" (121 mm)	.03
607-3	cabinet-tip	3/32" (2.4 mm)	3" (76 mm)	5-3/4" (146 mm)	.04
607-4	cabinet-tip	3/32" (2.4 mm)	4" (102 mm)	6-3/4" (171 mm)	.04
608-2	cabinet-tip	1/8" (3.2 mm)	2" (51 mm)	4-3/4" (121 mm)	.03

Cat No.	Tip Type	Tip Size	Shank Length	Overall Length	Weight (lbs.)
608-3	cabinet-tip	1/8" (3.2 mm)	3" (76 mm)	5-3/4" (146 mm)	.04
608-4	cabinet-tip	1/8" (3.2 mm)	4" (102 mm)	6-3/4" (171 mm)	.05
608-6	cabinet-tip	1/8" (3.2 mm)	6" (152 mm)	8-3/4" (222 mm)	.05
608-8	cabinet-tip	1/8" (3.2 mm)	8" (203 mm)	10-3/4" (273 mm)	.05
608-10	cabinet-tip	1/8" (3.2 mm)	10" (254 mm)	12-3/4" (324 mm)	.05

Coated Cabinet-Tip Screwdrivers – Round-Shanks

Additional Features:

- Plastic coated for circuit protection only. NOT INSULATED.
- Special plastic coating resists cutting, cracking and chipping.
- Thin coating permits use in confined areas.



620-4

Cat. No.	Tip Size	Shank Length	Overall Length	Weight (lbs.)
620-3	3/16" (5 mm)	3" (76 mm)	6-3/4" (171 mm)	.15
621-6	3/16" (5 mm)	6" (152 mm)	9-3/4" (248 mm)	.20
621-8	3/16" (5 mm)	8" (203 mm)	11-3/4" (298 mm)	.20
621-10	3/16" (5 mm)	10" (254 mm)	13-3/4" (349 mm)	.25

Cat. No.	Tip Size	Shank Length	Overall Length	Weight (lbs.)
Heavy-Duty Shanks				
620-4	1/4" (6 mm)	4" (102 mm)	8-11/32" (212 mm)	.20
620-6	5/16" (8 mm)	6" (152 mm)	10-15/16" (278 mm)	.40
620-8	3/8" (10 mm)	8" (203 mm)	13-7/16" (341 mm)	.60

Square-Recess Tip Screwdrivers – Round-Shanks

Additional Features:

- Color-coded handle ends for quick and easy identification.
- Round shank with Square-Recess tip.
- Chrome plated shank for corrosion resistance.

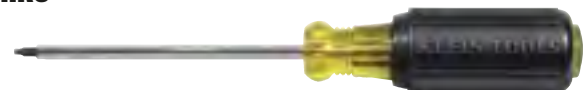

660

Cat. No.	Tip Size	Color Code	Shank Length	Overall Length	Weight (lbs.)
660	#0	yellow	4" (102 mm)	7-3/4" (197 mm)	.20
661	#1	green	4" (102 mm)	7-3/4" (197 mm)	.20
662	#2	red	4" (102 mm)	8-1/4" (210 mm)	.30
663	#3	black	4" (102 mm)	8-1/4" (210 mm)	.30
665	#1	green	8" (203 mm)	11-3/4" (298 mm)	.30

Cat. No.	Tip Size	Color Code	Shank Length	Overall Length	Weight (lbs.)
666	#2	red	8" (203 mm)	12-1/4" (311 mm)	.40
667	#3	black	8" (203 mm)	12-1/4" (311 mm)	.40

Refer to the insulated section for insulated screwdrivers.

All dimensions are in inches and (millimeters).

WARNING: Always wear approved eye protection.

WARNING: NOT insulated. Will NOT protect against electrical shock.

WARNING: Do NOT use to pry or chisel.

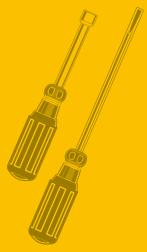

Cushion-Grip Screwdrivers

TORX® Screwdrivers – Round-Shanks

Additional Features:

- Color-coded handle ends for quick and easy identification.
- TORX® tip drive cuts slippage, saves fasteners and transmits more torque to the work.
- Chrome-plated shank for corrosion resistance.

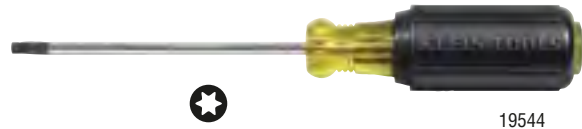

Cat. No.	TORX® Size	Color Code	Shank Length	Overall Length	Weight (lbs.)
19542	T15	yellow	4" (102 mm)	8-5/16" (211 mm)	.20
19543	T20	green	4" (102 mm)	8-5/16" (211 mm)	.25
19544	T25	blue	4" (102 mm)	8-5/16" (211 mm)	.25

Cat. No.	TORX® Size	Color Code	Shank Length	Overall Length	Weight (lbs.)
19545	T27	brown	4" (102 mm)	8-5/16" (211 mm)	.25
19546	T30	red	4" (102 mm)	8-5/16" (211 mm)	.25

TORX® is a registered trademark of Acument Intellectual Properties, LLC.

Rapi-Driv® Screwdrivers

Rapi-Driv® Screwdrivers

Additional Features:

- Crank-action handle spins screws fast with one hand.
- Saves time and effort, especially on long-threaded screws in switch plates, light fixtures, etc.



Cat. No.	Tip Type	Tip Size	Shank Length	Overall Length	Weight (lbs.)
670-3		cabinet-tip 3/16" (5 mm)	4" (102 mm)	7-3/4" (197 mm)	.15
670-6		cabinet-tip 3/16" (5 mm)	6" (152 mm)	9-3/4" (248 mm)	.20
671-6		cabinet-tip 1/4" (6 mm)	6" (152 mm)	9-3/4" (248 mm)	.20
681-6		Phillips-tip #1	6" (152 mm)	9-3/4" (248 mm)	.20
682-6		Phillips-tip #2	6" (152 mm)	9-3/4" (248 mm)	.25
691-6		square-recess #1	6" (152 mm)	9-3/4" (248 mm)	.35
692-6		square-recess #2	6" (152 mm)	9-3/4" (248 mm)	.35

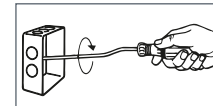

Interchangeable Rapi-Driv®

Additional Features:

- Interchangeable bit holder allows quick switching between tip styles and works with other standard size bits.
- Crank-action handle allows you to spin screws fast with one hand.
- Blast finish bit provides firm grip on fasteners to reduce cam out.

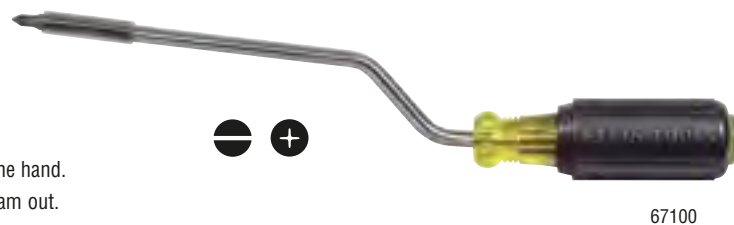

Cat. No.	Contains	Shaft Length	Overall Length	Weight (lbs.)
67100	3/16" slotted, #2 Phillips	6" (152 mm)	9-3/4" (248 mm)	.26

2-in-1 Replacement Bit

Cat. No.	Fits	Description	Quantity	Weight (lbs.)
67101	2-in-1 Rapi-Driv®, 10-in-1, 11-in-1 and 10-Fold™	3/16" slotted, #2 Phillips replacement bit	contains 2 bits	.012

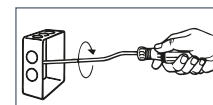

All dimensions are in inches and (millimeters).

WARNING: Always wear approved eye protection.

WARNING: NOT insulated. Will NOT protect against electrical shock.

WARNING: Do NOT use to pry or chisel.

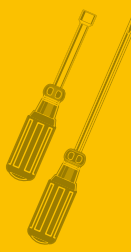

Specialty Screwdrivers

Demolition Screwdrivers — Keystone-Tip

- Engineered, manufactured and tested for prying and chiseling.
- Plated metal strike cap to protect handle from hammer blows.
- Heat treated metal shaft runs complete length of handle to metal strike cap to transfer metal strike force.

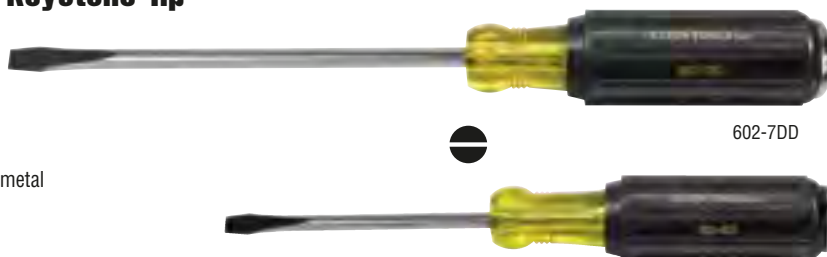

Cat. No.	Tip Size	Tip Type	Blade Length	Overall Length	Weight (lbs.)
602-4DD	1/4"	keystone	4" (102 mm)	9" (229 mm)	.37 (0.17 kg.)
602-7DD	5/16"	keystone	7" (178 mm)	12-3/8" (314 mm)	.56 (0.25 kg.)

Power Conduit Reamer

- Ream 1/2", 3/4" and 1" conduit and install fittings in a fraction of the time.
- Reduce time on projects with large quantities of conduit runs.
- Designed to fit into power drill chucks and quick release adapters; impact ready.
- Includes precision engineered replaceable reaming blade.
- Replacement blades are available and the only approved blade for use in our tool.
- Replacement bits are available but any standard 1/4" hex bit will work.



85091



Cat. No.	Conduit Capacity	Weight
85091	conduit reamer drill head for 1/2", 3/4" and 1" conduit	.33 lbs. (0.15 kg.)
19353	conduit reamer replacement blade	.01 lbs. (0.004 kg.)
SQ2115	#2 square recess replacement bit, 15-pack	.01 lbs. (0.004 kg.)

Conduit-Fitting and Reaming Screwdriver

Additional Features:

- Hooded-blade design keeps tip from slipping out of screws, especially when tightening hard-to-reach conduit fittings. Thicker hood is designed for rugged use.
- Reams and smooths 1/2" (13 mm), 3/4" (19 mm), and 1" (25 mm) thin-wall conduit ends to protect wire and permit correct installation of fittings.
- Reams both the inside and outside of the conduit at the same time.
- Replaceable reaming blade is now held in place with a 1/16" set screw.



85191

Cat. No.	Tip Size	Shank Length	Overall Length	Weight (lbs.)
85191	5/16" (8 mm)	2-1/2" (64 mm)	7-1/2" (191 mm)	.50
19353	conduit reamer replacement blade kit			.01

Conduit Reamer

- Locks onto screwdrivers; reams and smooths thin-wall conduit.
- Reams ID and OD at the same time.
- Two set-screws for round- and square-shank screwdrivers.
- Fits up to 3/8" (10 mm) keystone-tip screwdrivers.
- NOT for use on power tools.



19352

Cat. No.	Conduit Capacity	Weight (lbs.)
19352	1/2", 3/4", 1"	.20
19353	conduit reamer replacement blade kit for 19352	.01
19351	conduit reamer replacement blade for 19350	.01

All dimensions are in inches and (millimeters).

⚠ WARNING: NOT insulated. Will NOT protect against electrical shock.

⚠ WARNING: Always wear approved eye protection.

⚠ WARNING: Do NOT use to pry or chisel.

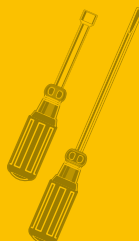

Specialty Screwdrivers

Screw-Holding Screwdrivers

Additional Features:

- Starts and drives screws with one hand when working in hard-to-reach spaces.
- Cushion-Grip handle provides superior torque and comfort with non-slip grip.



32215

Cat. No.	Screwdriver Type	Shank Length	Overall Length	Weight (lbs.)
32215	1/4" cabinet	7" (178 mm)	11-1/4" (276 mm)	0.32
32216	#2 Phillips	7" (178 mm)	11-1/4" (276 mm)	0.32

Terminal Block Screwdriver

Additional Features:

- Precision-machined tip provides exact fit for terminal block screws.
- Tip is up to 19% stronger than competitors.
- Tip provides 76% higher torque value than the required ASME B107 Standard.
- Cushion-Grip handle offers greater torque comfort.

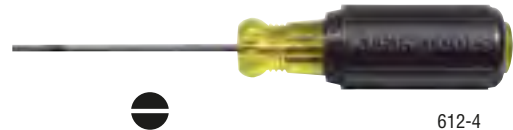

612-4

Cat. No.	Shank Top Width	Shank Length	Overall Length	Weight (lbs.)
612-4	1/8" (3.2 mm)	4" (100 mm)	7-3/4" (200 mm)	0.15

Wire Bending Cabinet-Tip Screwdrivers – Round-Shanks

Additional Feature:

- Metal stud offers a convenient and easy way to bend, loop and connect solid wire when installing outlets and switches.



605-6B

Cat. No.	Tip Size	Shank Length	Overall Length	Bends AWG Gauges	Finish	Weight (lbs.)
605-4B	1/4" (6 mm)	4" (102 mm)	8-11/32" (212 mm)	Nos. 10, 12, 14	chrome-plated	0.25
605-6B	1/4" (6 mm)	6" (152 mm)	10-11/32" (263 mm)	Nos. 10, 12, 14	chrome-plated	0.30

Wire Bending Phillips-Tip Screwdrivers – Round-Shanks

Additional Feature:

- Metal stud offers a convenient and easy way to bend, loop and connect solid wire when installing outlets and switches.



603-4B

Cat. No.	Tip Size	Shank Length	Overall Length	Bends AWG Gauges	Finish	Weight (lbs.)
603-3B	#1	3" (76 mm)	6-3/4" (171 mm)	Nos. 12 and 14	chrome-plated	0.15
603-4B	#2	4" (102 mm)	8-5/16" (211 mm)	Nos. 10, 12, 14	chrome-plated	0.25

Wire Bending Square-Recess Tip Screwdrivers – Round Shanks

Additional Feature:

- Metal stud offers a convenient and easy way to bend, loop and connect solid wire when installing outlets and switches.

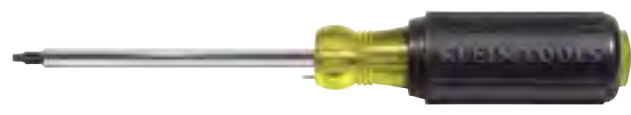

661B

Cat. No.	Tip Size	Shank Length	Overall Length	Bends AWG Gauges	Finish	Weight (lbs.)
661B	#1	4" (102 mm)	8-1/4" (210 mm)	Nos. 10, 12, 14	chrome-plated	0.20
662B	#2	4" (102 mm)	8-1/4" (210 mm)	Nos. 10, 12, 14	chrome-plated	0.30

All dimensions are in inches and (millimeters).

WARNING: Always wear approved eye protection.

WARNING: NOT insulated. Will NOT protect against electrical shock.

WARNING: Do NOT use to pry or chisel.



Multi-Bit Screwdrivers/Nut Drivers

Heavy-Duty Multi-Bit Screwdriver/Nut Driver

- Superior torque for tough applications.
- Interchangeable shaft holds 6 universal tips; converts to 3 nut driver sizes and 1 hex driver
- Strong, heat-treated nut drivers for improved torque.



32557

Cat. No.	Shaft Length	Overall Length	Weight
32557	2.95" (75 mm)	7.9" (201 mm)	0.48



Ratcheting Multi-Bit Screwdriver/Nut Driver

- High-torque ratcheting mechanism for tough applications.
- Shaft holds 6 universal tips; converts to 3 nut driver sizes and 1 hex driver.
- Strong, heat-treated nut drivers for improved torque.
- 3-way ratcheting mechanism for forward, reverse and locked positions.



32558

Cat. No.	Shaft Length	Overall Length	Weight
32558	2.95" (75 mm)	8.0" (203 mm)	0.71



Extended-Reach Multi-Bit Screwdrivers/Nut Drivers

- Interchangeable shaft holds 4 universal tips and converts to 2 nut driver sizes.
- Extended shafts and blades provide 39% longer reach.
- Shaft holds 4 universal tips and converts to 2 nut driver sizes.
- Small diameter shaft for comfortable grip and quick, easy turning.



32559

Cat. No.	Shaft Length	Overall Length	Weight
32559	4.11" (104 mm)	9.1" (231 mm)	0.41
32560	4.11" (104 mm)	9.1" (231 mm)	0.41

Cat. No. 32560



Cat. No. 32559



Stubby Multi-Bit Screwdriver/Nut Driver

- Compact design features standard 1-1/4" shaft allowing easy access to tight work spaces.
- Shaft holds 4 universal tips and converts to 2 nut driver sizes.



32561

Cat. No.	Shaft Length	Overall Length	Weight
32561	1.27" (32 mm)	3.2" (81 mm)	0.16 lbs. (0.07 kg.)
32562	1.27" (32 mm)	3.2" (81 mm)	0.16 lbs. (0.07 kg.)

Cat. No. 32561



Cat. No. 32562



All dimensions are in inches and (millimeters).

⚠ WARNING: NOT insulated. Will NOT protect against electrical shock.

⚠ WARNING: Always wear approved eye protection.

⚠ WARNING: Do NOT use to pry or chisel.

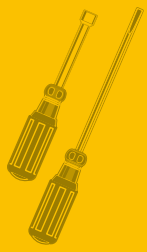

Multi-Bit Screwdrivers/Nut Drivers

5-in-1 Screwdriver/Nut Driver

- End of handle is marked to quickly identify tool.



32476

Cat. No.	Contains	Weight (lbs.)
32476	5/16" nut driver, #1 and #2 Phillips, 9/32" slotted and 3/16" slotted	.35

10-in-1 Screwdriver/Nut Driver

- End of handle is marked to quickly identify tool.



TORX® is a registered trademark of Acument Intellectual Properties, LLC.



32477

Cat. No.	Contains	Weight (lbs.)
32477	5/16" and 1/4" nut drivers, #1 and #2 Phillips, 1/4" and 3/16" slotted, T10 and T15 TORX®, #1 and #2 square-recess	.35

11-in-1 Screwdriver/Nut Driver

- Integrated screwdriver/nut driver shaft holds 8 popular tips and converts to 3 nut driver sizes.
- End of handle is marked to quickly identify tool.



TORX® is a registered trademark of Acument Intellectual Properties, LLC.



32500

Cat. No.	Contains	Weight (lbs.)
32500	3/8", 5/16" and 1/4" nut drivers, #1 and #2 Phillips, 1/4" and 3/16" slotted, T10 and T15 TORX®, #1 and #2 square-recess	.44

11-in-1 Screwdriver/Nut Driver with Schrader® Valve Removal/ Installation Bit

- Includes unique style bit for installation/removal of common TR-4 Schrader® valves and aggressive thread extractor tip for backing out broken cores.
- Great for HVAC and other industrial applications.



Schrader® is a registered trademark of Schrader International, Inc.



32527

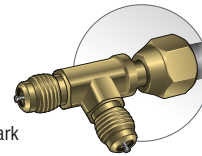

Cat. No.	Contains	Weight (lbs.)
32527	3/8", 5/16" and 1/4" nut drivers, #1 and #2 Phillips, #1 square and #2 square, 1/4" and 3/16" slotted, Schrader® valve core removal/installation – extractor	.44

10-in-1 Folding Screwdriver/Nut Driver

- Conveniently folds up for easy storage or to fit into your pocket.
- Each driver arm contains four interchangeable bit styles and two nut drivers.
- Unfold each driver arm up to a full 180° for straight on driving power, or at 90° for extra leverage on stubborn fasteners.
- The quick release button easily unlocks a fully extended driver arm.

10-FOLD®



32535



32536



32537



32538



32539

TORX® is a registered trademark of Acument Intellectual Properties, LLC.

Cat. No.	Handle Color	Description	Weight (lbs.)
32534	blue	5/16" & 1/4" nut drivers, #1 and #2 Phillips, 1/4" & 3/16" slotted, #1 and #2 square-recess, and Schrader® valve core removal/installation – extractor	0.37
32535	black	5/16" & 1/4" nut drivers, #1 and #2 Phillips, 1/4" & 3/16" slotted, T10 & T15 TORX®, and #1 and #2 square-recess	0.37
32536	green	5/16" & 1/4" nut drivers, T6, T7, T8, T10, T15, T20, T25, T27 TORX®	0.37
32537	green	5/16" & 1/4" nut drivers, T7, T8, T9, T10, T15, T20, T25, T27 TORX®	0.37
32538	red	5/16" & 1/4" nut drivers, 1/16", 5/64", 3/32", 7/64", 1/8", 9/64", 5/32", 3/16" standard hex	0.37
32539	blue	5/16" & 1/4" nut drivers, .9 mm, 1.3 mm, 1.5 mm, 2 mm, 2.5 mm, 3 mm, 4 mm, 5 mm metric hex	0.37

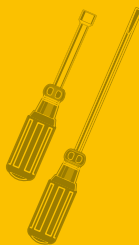

Replacement Parts Multi-Bit Screwdriver/Nut Drivers

Replacement Bits for Screwdriver/Nut Drivers

- Precision-machined tips for exact fit into fastener.



32484



32482



32483

Replacement Bits for Multi-Bit Interchangeable Screwdriver/Nut Drivers (32557, 32558, 32559, 32560, 32561)

Cat. No.	Fits	Description	Quantity
32392	32557 and 32558	Heavy Duty Main Blade Barrel	contains 1 unit
32394	32557 and 32558	Heavy Duty Secondary Blade Barrel	contains 2 units
32395	32559 and 32560	Extended Blade Barrel	contains 1 unit
32396	32561	Stubby Blade Barrel	contains 1 unit
32397	32557 and 32558	Screwdriver Bit & #2 PH x #1 Square	contains 2 bits
32398	32557, 32558 and 32561	Screwdriver Bit & #1 PH x 1/4 Slotted	contains 2 bits
32399	32557 and 32558	Screwdriver Bit & #2 Square x 3/16 Slotted	contains 2 bits
32400	32559	Extended Screwdriver Bit & #2 PH x #1 PH	contains 2 bits
32401	32559	Extended Screwdriver Bit & 3/16 Slotted x 1/4 Slotted	contains 2 bits
32410	32560	Extended Screwdriver Bit & #2 Square x #2 PH	contains 2 bits
32411	32560	Extended Screwdriver Bit & #1 Square x 1/4 Slotted	contains 2 bits
32412	32561	Screwdriver Bit & #2 PH x 3/16 Slotted	contains 2 bits

Replacement Bits for 5-in-1 Interchangeable Screwdriver/Nut Drivers

Cat. No.	Fits	Description	Quantity
32478	5-in-1 (Cat. No. 32476)	#1 Phillips – 3/16" slotted	contains 1 bit
32479	5-in-1 (Cat. No. 32476)	#2 Phillips – 9/32" slotted	contains 1 bit

Replacement Bits for 10-in-1, 11-in-1 and 10-Fold® Interchangeable Screwdriver/Nut Drivers

Cat. No.	Fits	Description	Quantity
32482	10-in-1, 11-in-1 and 10-Fold™	#1 Phillips & 3/16" Slotted	contains 2 bits
32483	10-in-1, 11-in-1 and 10-Fold™	#2 Phillips & 1/4" Slotted	contains 2 bits
32484	10-in-1, 11-in-1 and 10-Fold™	#1 Square & #2 Square	contains 2 bits
67101	10-in-1, 11-in-1 and 10-Fold™	#2 Phillips & 3/16" Slotted	contains 2 bits
32540	10-in-1, 11-in-1 and 10-Fold™	TT7 & TT8 Tamperproof TORX®	contains 2 bits
32541	10-in-1, 11-in-1 and 10-Fold™	TT9 & TT10 Tamperproof TORX®	contains 2 bits
32542	10-in-1, 11-in-1 and 10-Fold™	TT15 & TT20 Tamperproof TORX®	contains 2 bits
32543	10-in-1, 11-in-1 and 10-Fold™	TT25 & TT27 Tamperproof TORX®	contains 2 bits
32544	10-in-1, 11-in-1 and 10-Fold™	#6 TORX® & #7 TORX®	contains 2 bits
32485	10-in-1, 11-in-1 and 10-Fold™	#10 TORX® & #15 TORX®	contains 2 bits
32545	10-in-1, 11-in-1 and 10-Fold™	#T8 TORX® & #10 TORX®	contains 2 bits
32546	10-in-1, 11-in-1 and 10-Fold™	#T25 TORX® & #T27 TORX®	contains 2 bits
32547	10-in-1, 11-in-1 and 10-Fold™	3/32" Hex & 7/64" Hex	contains 2 bits
32548	10-in-1, 11-in-1 and 10-Fold™	5/32" Hex & 3/16" Hex	contains 2 bits
32549	10-in-1, 11-in-1 and 10-Fold™	1/16" Hex & 5/64" Hex	contains 2 bits
32550	10-in-1, 11-in-1 and 10-Fold™	1/8" Hex & 9/64" Hex	contains 2 bits
32551	10-in-1, 11-in-1 and 10-Fold™	.9 mm Hex & 1.3 mm Hex	contains 2 bits
32552	10-in-1, 11-in-1 and 10-Fold™	1.5 mm Hex & 2 mm Hex	contains 2 bits
32553	10-in-1, 11-in-1 and 10-Fold™	2.5 mm Hex & 3 mm Hex	contains 2 bits
32554	10-in-1, 11-in-1 and 10-Fold™	4 mm Hex & 5 mm Hex	contains 2 bits

TORX® is a registered trademark of Acument Intellectual Properties, LLC.

All dimensions are in inches and (millimeters).

⚠ WARNING: NOT insulated. Will NOT protect against electrical shock.

⚠ WARNING: Always wear approved eye protection.

⚠ WARNING: Do NOT use to pry or chisel.

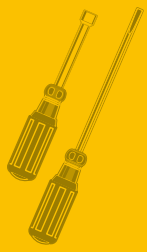

Multi-Bit Screwdrivers/Nut Drivers

Non-Ratcheting Magnetic Screwdriver with 32-Piece Tamperproof Bit Set

- Cushion-Grip handle for superior torque and comfort.
- Sturdy bit and screw holding magnet allows for screws to fit securely in place for easy use.
- Includes complete tamperproof bit set in block.



32510

Cat. No.	Set Contains	Weight (lbs.)
32510		.71

Bits Included

TORX® – T7, T8, T10, T15, T20, T25, T27, T30 and T40
Fraction Hex – 3/32", 7/64", 1/8", 9/64", 5/32", and 3/16"
Metric Hex – 2 mm, 2.5 mm, 3 mm, 4 mm, and 5 mm
Spanner – 4, 6, 8, and 10
Tri-Wing® – 1, 2, 3 and 4
TORQ-SET® – 6, 8 and 10
1/4" square to 1/4" hex adapter to drive sockets

TORX® is a registered trademark of Acument Intellectual Properties, LLC.
TORQ-SET® and Tri-Wing® are registered trademarks of Phillips Screw Co.

Magnetic Screwdriver Bit Sets

- Durable PVC black block allows for easy storage of standard bits.
- Block slides over most screwdriver shafts for easy bit access and storage.
- Industrial strength, heat-treated steel bits for long lasting use.

32-Piece Standard Tip Bit Set



32526

Cat. No.	Set Contains	Weight (lbs.)
32526		.425

Bits Included

Hex – 5/64", 3/32", 7/64", 1/8", 9/64", 5/32" and 3/16"
Phillips – #0, #1, #2 (Qty. 3), and #3
Square Recess – #1, #2, and #3
TORX® – T6, T7, T8, T10, T15, T20 and T25
Slotted – 3-4, 5-6, 6-8, 8-10, 10-12, 12-14 screw sizes
Clutch – 5/32" and 3/16"
1/4" square to 1/4" hex adapter to drive sockets

TORX® is a registered trademark of Acument Intellectual Properties, LLC.
TORQ-SET® and Tri-Wing® are registered trademarks of Phillips Screw Co.

32-Piece Tamperproof Tip Bit Set



32525

Cat. No.	Set Contains	Weight (lbs.)
32525		.425

Bits Included

TORX® – T7, T8, T10, T15, T20, T25, T27, T30 and T40
Fraction Hex – 3/32", 7/64", 1/8", 9/64", 5/32", and 3/16"
Metric Hex – 2 mm, 2.5 mm, 3 mm, 4 mm, and 5 mm
Spanner – 4, 6, 8, and 10
Tri-Wing® – 1, 2, 3 and 4
TORQ-SET® – 6, 8 and 10
1/4" square to 1/4" hex adapter to drive sockets

All dimensions are in inches and (millimeters).

▲WARNING: Always wear approved eye protection.

▲WARNING: NOT insulated. Will NOT protect against electrical shock.

▲WARNING: Do NOT use to pry or chisel.

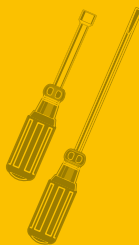

Journeyman™ Screwdrivers

JOURNEYMAN

Features:

Hex-shaped welded bolster offers additional strength between the blade and handle.

Sleek tri-lobe handle features an ultra comfortable soft-grip material molded over a solid inner core to create exceptional control, grip, and balance.

Precision-machined tip for exact fit into the fastener.

Exceptionally hard steel shaft efficiently transfers every bit of torque generated into the tip.

Tip-Ident® quickly identifies the type of screwdriver and tip orientation.



Meets or exceeds applicable ASME / ANSI specifications.

5-Piece Journeyman™ Screwdriver Set

Additional Features:

- General purpose selection of the most frequently used screwdrivers.

Cat. No.	Set Contains	Weight (lbs.)	
JSDS01		1.15	
Cat. No.	Description	Shaft Length	Overall Length
JSD6C06	3/16" cabinet-tip	6" (152 mm)	10-1/4" (260 mm)
JSD4K08	1/4" keystone-tip	4" (102 mm)	9" (228 mm)
JSD6K09	5/16" keystone-tip	6" (152 mm)	11" (279 mm)
JSD4PH1	#1 Phillips-tip	4" (102 mm)	8-1/4" (210 mm)
JSD4PH2	#2 Phillips-tip	4" (102 mm)	9" (228 mm)



JSDS01

All dimensions are in inches and (millimeters).

⚠ WARNING: NOT insulated. Will NOT protect against electrical shock.

⚠ WARNING: Always wear approved eye protection.

⚠ WARNING: Do NOT use to pry or chisel.

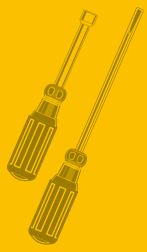

Journeyman™ Screwdriver Sets

JOURNEYMAN

7-Piece Journeyman™ Screwdriver Set

Additional Features:

- Accommodates a broad range of standard fastener sizes.



Cat. No.	Set Contains	Weight (lbs.)
JSDS02		1.65

Cat. No.	Description	Shaft Length	Overall Length
JSD4C06	3/16" cabinet-tip	4" (102 mm)	8-1/4" (210 mm)
JSD6C06	3/16" cabinet-tip	6" (152 mm)	10-1/4" (260 mm)
JSD4K08	1/4" keystone-tip	4" (102 mm)	9" (228 mm)
JSD6K09	5/16" keystone-tip	6" (152 mm)	11" (279 mm)
JSD4PH1	#1 Phillips-tip	4" (102 mm)	8-1/4" (210 mm)
JSD4PH2	#2 Phillips-tip	4" (102 mm)	9" (228 mm)
JSD6PH3	#3 Phillips-tip	6" (152 mm)	11" (279 mm)

JSDS02

Journeyman™ Screwdrivers

Journeyman™ Cabinet-Tip Screwdrivers – Round Shaft

Additional Features:

- Narrow cabinet-tip permits blade access where space is limited.
- Exceptionally hard steel shaft efficiently transfers torque into the tip.



JSD6C06

Cat. No.	Shaft Tip Width	Shaft Length	Overall Length	Weight (lbs.)
JSD4C06	3/16" (5 mm)	4" (102 mm)	8-1/4" (210 mm)	0.15
JSD6C06	3/16" (5 mm)	6" (152 mm)	10-1/4" (260 mm)	0.15



Journeyman™ Phillips-Tip Screwdrivers – Round Shaft

Additional Features:

- Tips are precision machined to provide a consistent symmetry.
- Provides accurate fit and torque without slippage.



JSD4PH2

Cat. No.	Tip Size	Shaft Length	Overall Length	Weight (lbs.)
JSD4PH1	#1	4" (102 mm)	8-1/4" (210 mm)	0.15
JSD4PH2	#2	4" (102 mm)	9" (228 mm)	0.25
JSD6PH3	#3	6" (152 mm)	11" (279 mm)	0.35



Journeyman™ Keystone-Tip Screwdrivers – Round Shaft

Additional Features:

- The most popular flat tip style used in high torque applications.
- Hex bolster reinforces blade for hard use and shows for wrench assisted turning.



JSD6K09

Cat. No.	Shaft Tip Width	Shaft Length	Overall Length	Weight (lbs.)
JSD4K08	1/4" (6 mm)	4" (102 mm)	9" (228 mm)	0.25
JSD6K09	5/16" (8 mm)	6" (152 mm)	11" (279 mm)	0.35



All dimensions are in inches and (millimeters).

⚠ WARNING: NOT insulated. Will NOT protect against electrical shock.

⚠ WARNING: Always wear approved eye protection.

⚠ WARNING: Do NOT use to pry or chisel.

Screwdrivers, Nut Drivers & Accessories

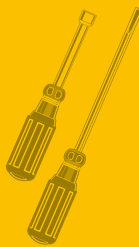

Plastic-Handle Screwdriver Set

Features:

Meets or exceeds applicable ASME / ANSI specifications.

Smooth Comfordome® handles fit the palm of the hand comfortably.

Nickel-chrome, precision-forged and polished blades with black tips.

Tough amber plastic handle.

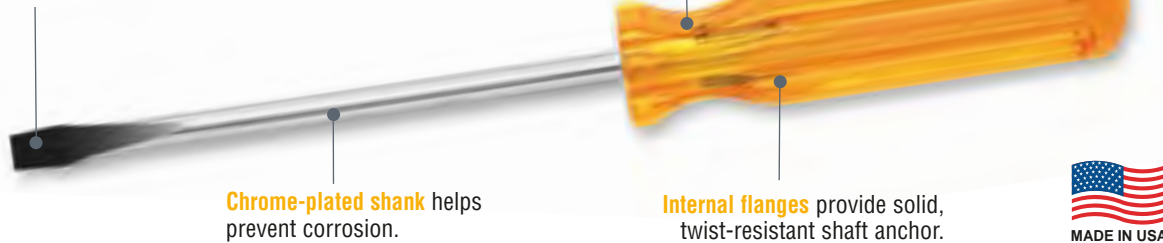

Chrome-plated shank helps prevent corrosion.

Internal flanges provide solid, twist-resistant shaft anchor.



7-Piece Combination Screwdriver Set

Additional Features:

- Set contains two Phillips-tip screwdrivers, two slotted keystone-tip screwdrivers and three popular cabinet-tip screwdrivers.

Cat. No.	Set Contains	Weight (lbs.)
85276		1.10
Cat. No.	Description	Shank Length
BD111	#1 Phillips-tip	3" (76 mm)
BD122	#2 Phillips-tip	4" (102 mm)
BD284	1/4" square-shank, keystone-tip	4" (102 mm)
BD306	5/16" square-shank, keystone-tip	6" (152 mm)
A216-3	1/8" round-shank, cabinet-tip	3" (76 mm)
A216-4	1/8" round-shank, cabinet-tip	4" (102 mm)
A216-6	1/8" round-shank, cabinet-tip	6" (152 mm)



85276

Pocket-Clip Screwdrivers

Additional Features:

- Round-shank screwdrivers ranging from 3-1/4" (82 mm) to 6-7/16" (164 mm) long.
- Convenient pocket clip.
- Cat. No. A010 has keystone-tip, Cat. No. P12 has Phillips-tip, and all others have cabinet-tip.

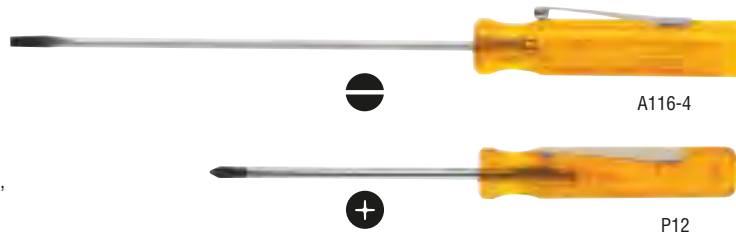

A116-4

P12

Cat. No.	Tip Size	Shank Length	Overall Length	Weight (lbs.)
Keystone-Tip and Cabinet-Tip, Pocket-Clip Screwdrivers				
A010	3/32" (2.4 mm)	1-3/8" (35 mm)	3-1/4" (82 mm)	.03
A130-2	1/8" (3.2 mm)	2" (51 mm)	3-7/8" (98 mm)	.05
A130-3	1/8" (3.2 mm)	3" (76 mm)	4-7/8" (124 mm)	.04
A116-2	3/32" (2.4 mm)	2" (51 mm)	4-7/16" (113 mm)	.05
A116-3	3/32" (2.4 mm)	3" (76 mm)	5-7/16" (138 mm)	.03
A116-4	3/32" (2.4 mm)	4" (102 mm)	6-7/16" (164 mm)	.03
A131-2	1/8" (3.2 mm)	2" (51 mm)	4-7/16" (113 mm)	.05

Cat. No.	Tip Size	Shank Length	Overall Length	Weight (lbs.)
Phillips-Tip, Pocket-Clip Round-Shank Screwdriver				
P12	#0	2 1/2" (63 mm)	5" (124 mm)	.05

All dimensions are in inches and (millimeters).

WARNING: Always wear approved eye protection.

WARNING: NOT insulated. Will NOT protect against electrical shock.

WARNING: Do NOT use to pry or chisel.

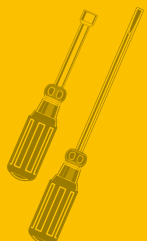

Plastic-Handle Screwdrivers

Midget Screwdriver

Additional Features:

- Specially designed for delicate instrument work.
- Keystone-tip screwdriver.



A000

Cat. No.	Tip Size	Shank Length	Overall Length	Weight (lbs.)
A000	3/32" (2 mm)	1-1/2" (38 mm)	2-7/8" (73 mm)	.02

Keystone-Tip Screwdrivers – Square-Shanks

Additional Features:

- Oversized handle is 35% larger than comparable screwdriver handles.
- Delivers up to 50% extra power to perform tough jobs with minimum effort.



BD306

Cat. No.	Tip Size	Shank Length	Overall Length	Weight (lbs.)
BD284	1/4" (6.3 mm)	4" (102 mm)	8-1/2" (216 mm)	.25
BD286	1/4" (6.3 mm)	6" (152 mm)	10-1/2" (267 mm)	.30
BD306	5/16" (7.9 mm)	6" (152 mm)	11-3/16" (284 mm)	.35
BD308	5/16" (7.9 mm)	8" (203 mm)	13-3/16" (335 mm)	.40

Cat. No.	Tip Size	Shank Length	Overall Length	Weight (lbs.)
BD310	5/16" (7.9 mm)	10" (254 mm)	15-3/16" (385 mm)	.50
BD410	3/8" (9.5 mm)	10" (254 mm)	15-3/16" (385 mm)	.60
BD412	3/8" (9.5 mm)	12" (305 mm)	17-3/16" (437 mm)	.75
C718	3/8" (9.5 mm)	18" (457 mm)	23-5/16" (592 mm)	.95

Keystone-Tip Screwdrivers – Round-Shanks

Additional Features:

- Oversized handle is 35% larger than comparable screwdriver handles.
- Delivers up to 50% extra power to perform tough jobs with minimum effort.



BD156

Cat. No.	Tip Size	Shank Length	Overall Length	Weight (lbs.)
BD143	7/32" (5.6 mm)	3" (76 mm)	7-1/2" (190 mm)	.20
BD144	1/4" (6.3 mm)	4" (102 mm)	8-1/2" (216 mm)	.25
BD146	1/4" (6.3 mm)	6" (152 mm)	10-1/2" (267 mm)	.25
BD156	5/16" (7.9 mm)	6" (152 mm)	11-3/16" (284 mm)	.35

Cat. No.	Tip Size	Shank Length	Overall Length	Weight (lbs.)
BD158	5/16" (7.9 mm)	8" (203 mm)	13-3/16" (335 mm)	.40
BD408	3/8" (9.5 mm)	8" (203 mm)	13-3/16" (335 mm)	.50
BD510	3/8" (9.5 mm)	10" (254 mm)	15-3/16" (386 mm)	.55
70155	1/4" (6.3 mm)	20" (508 mm)	24-1/2" (622 mm)	.45

Cabinet-Tip Screwdrivers – Round-Shanks

Additional Features:

- Small-diameter shank for use in recessed holes or tight places.
- Well-suited for electrical and telecommunications work.



A216-6

Cat. No.	Tip Size	Shank Length	Overall Length	Weight (lbs.)
A216-2	1/8" (3.2 mm)	2" (51 mm)	5" (127 mm)	.05
A216-3	1/8" (3.2 mm)	3" (76 mm)	6" (152 mm)	.05
A216-4	1/8" (3.2 mm)	4" (102 mm)	7" (178 mm)	.05
A216-6	1/8" (3.2 mm)	6" (152 mm)	9" (228 mm)	.05
A216-8	1/8" (3.2 mm)	8" (203 mm)	11" (279 mm)	.05
A216-10	1/8" (3.2 mm)	10" (254 mm)	13" (330 mm)	.05

Cat. No.	Tip Size	Shank Length	Overall Length	Weight (lbs.)
A316-3	3/16" (4.8 mm)	3" (76 mm)	6-5/8" (168 mm)	.10
A316-4	3/16" (4.8 mm)	4" (102 mm)	7-5/8" (194 mm)	.10
A316-6	3/16" (4.8 mm)	6" (152 mm)	9-5/8" (244 mm)	.10
A316-8	3/16" (4.8 mm)	8" (203 mm)	11-5/8" (295 mm)	.15
A316-10	3/16" (4.8 mm)	10" (254 mm)	13-5/8" (346 mm)	.20

Profiliated Phillips-Tip Screwdrivers – Round-Shanks

Additional Features:

- Oversized handle is 35% larger than comparable screwdriver handles.
- Delivers up to 50% extra power to perform tough jobs with minimum effort.



BD122

Cat. No.	Tip Size	Shank Length	Overall Length	Weight (lbs.)
BD111	#1	3" (76 mm)	6-5/8" (168 mm)	.10
BD122	#2	4" (102 mm)	8-1/2" (216 mm)	.20
BD133	#3	6" (152 mm)	11-3/16" (284 mm)	.35
P18	#1	8" (203 mm)	11-1/2" (292 mm)	.15

Cat. No.	Tip Size	Shank Length	Overall Length	Weight (lbs.)
P28	#2	8" (203 mm)	11-5/8" (295 mm)	.20
P212	#2	12" (305 mm)	15-5/8" (397 mm)	.25
P202	#2	20" (508 mm)	24-1/2" (622 mm)	.55

All dimensions are in inches and (millimeters).

▲WARNING: Always wear approved eye protection.

▲WARNING: NOT insulated. Will NOT protect against electrical shock.

▲WARNING: Do NOT use to pry or chisel.

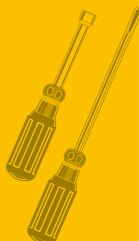

Specialty Plastic-Handle Screwdrivers

Magnetic Screwdriver Set

- Each screwdriver has a powerful magnet built into its shank to hold interchangeable bits and also screws.
- Comfortable handle for easier driving.
- Interchangeable bits store inside handle for quick access.
- Wide selection of bits for different screw types.



70035

Cat. No.	Bits Included	Shank Length with Bits	Overall Length	Weight (lbs.)
70035	3/16" and 9/32" slotted and #1 and #2 Phillips	3-3/4" (95 mm)	7-1/4" (184 mm)	.25

Ratcheting Screwdriver Set

- Slotted and Phillips-tip set.
- Contains a unique 3-position ratcheting screwdriver plus an assortment of blade types and/or sizes.
- Comfortable handle with an easy-to-open snap top.
- Interchangeable bits store inside the handle for quick access.



32473

Cat. No.	Bits Included	Shank Length with Bits	Overall Length	Weight (lbs.)
32473	3/16" and 9/32" slotted plus #1 and #2 Phillips	4-1/4" (108 mm)	8-3/4" (222 mm)	.40

Screwdriver Replacement Bits

- These precision-milled bits are 1" in length and are 1/4" hex.
- Fits replaceable-bit screwdrivers and other sockets that accept 1/4" hex bits.



4HT15

4H1R2

4HS932

4H1P2

Cat. No.	Bit Type	Tip Size	Weight (lbs.)
4HS316	slotted	3/16"	.02
4HS932	slotted	9/32"	.02
4H1P2	Phillips	#2	.02
4H1R1	square-recess	#1	.01
4H1R2	square-recess	#2	.01
4H1R3	square-recess	#3	.01
4HT15	TORX®	T15	.02
4HT20	TORX®	T20	.01
4HT25	TORX®	T25	.02
4HT27	TORX®	T27	.02

Cat. No.	Bit Type	Tip Size	Weight (lbs.)
4HT30	TORX®	T30	.02

Cat. No.	Weight (lbs.)
----------	---------------

Bit Sets	Bit Selection	Weight (lbs.)
70036	3/16", 9/32" slotted plus #1 and #2 Phillips tips	.05
70283	#1, #2, #3 square-recess tips	.05
70432	T15, T20, T25, T27, T30 TORX® tips	.05

TORX® is a registered trademark of Acument Intellectual Properties, LLC.

4-in-1 Screwdriver

- Versatile screwdriver with interchangeable, snap-in blades.
- Tool supplied with four different tips on two reversible blades.

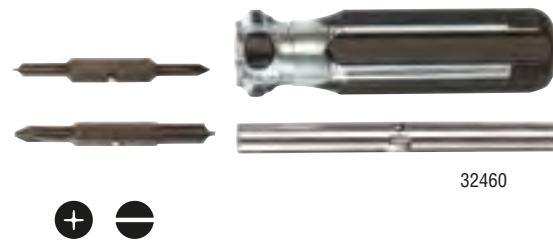

32460

Cat. No.	Description	Overall Length	Weight (lbs.)
32460	screwdriver with two dual-tipped blades	7-5/8" (194 mm)	.370
32478	#1 Phillips & 3/16" slotted	-	.036
32479	#2 Phillips & 9/32" slotted	-	.044

3-Piece Slotted Screw-Holding Screwdriver Set

- Not designed for torquing or tightening.

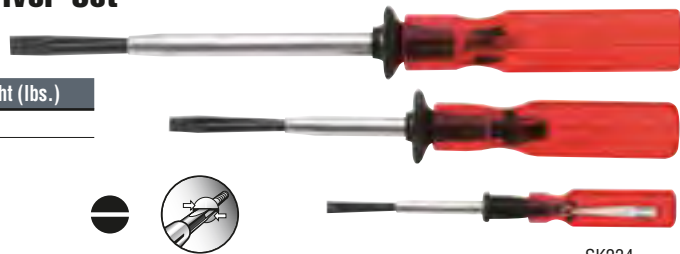

SK234

Cat. No.	Set Contains	Weight (lbs.)
SK234		.40

Cat. No.	Shank Size
K23	3/16" x 3" (5 mm x 76 mm)
K34	1/4" x 4" (6.3 mm x 102 mm)
K46	5/16" x 6" (8 mm x 152 mm)

All dimensions are in inches and (millimeters).

WARNING: NOT insulated. Will NOT protect against electrical shock.

WARNING: Always wear approved eye protection.

WARNING: Do NOT use to pry or chisel.

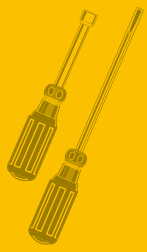

Specialty Plastic-Handle Screwdrivers

Slotted Screw-Holding Screwdrivers

- Split-blade screw-holding driver wedges into screw slot.
- Positive gripping action holds, starts, and drives slotted screws in awkward, hard-to-reach places.
- Not designed for torquing or tightening.

Cat. No.	Tip Size	Shank Length	Overall Length	Weight (lbs.)
K21†	1/16" (1.6 mm)	3" (76 mm)	5-1/4" (133 mm)	.05
K23	3/16" (5 mm)	3" (76 mm)	5-1/4" (133 mm)	.05
K28	3/16" (5 mm)	8" (203 mm)	10-1/4" (260 mm)	.10
K34‡	1/4" (6.3 mm)	4" (102 mm)	7-3/4" (197 mm)	.10
K36‡	1/4" (6.3 mm)	6" (152 mm)	9-3/4" (247 mm)	.15



Cat. No.	Tip Size	Shank Length	Overall Length	Weight (lbs.)
K38‡	1/4" (6.3 mm)	8" (203 mm)	11-3/4" (298 mm)	.20
K44	5/16" (8 mm)	4" (102 mm)	8-1/4" (209 mm)	.25
K46	5/16" (8 mm)	6" (152 mm)	10-1/4" (260 mm)	.25
K48	5/16" (8 mm)	8" (203 mm)	12-1/4" (311 mm)	.30

† Precision blade for use with small precision screws. Blade thickness of .028" expanding to .045".
 ‡ Blade thickness of .043" expanding to .085".
 Note: K21 and K23 have pocket clips.

Screw-Holding Screwdrivers

Phillips-Tip Screw-Holding Screwdrivers

- Blade separates to hold the fastener.
- Positive gripping action holds and starts Phillips screws in awkward, hard-to-reach places.
- Not designed for torquing or tightening.

Cat. No.	Overall Length	Weight (lbs.)
K14	5" (127 mm) with pocket clip	.05
K16	7" (178 mm)	.05
K19	9" (229 mm)	.05



Offset Screwdrivers

Slotted-Tip Offset Screwdrivers

- Designed for confined hard-to-reach applications.
- Two tip sizes for added convenience.

Cat. No.	For Screw Nos.	Overall Length	Tip Width	Weight (lbs.)
V01	2 to 6	3" (76 mm)	3/16" (5 mm)	.01
V02	6 to 10	4-1/4" (108 mm)	1/4" (6.3 mm)	.05
V03	8 to 12	5" (127 mm)	5/16" (8 mm)	.11
V04	12 to 16	6" (152 mm)	3/8" (9.5 mm)	.25

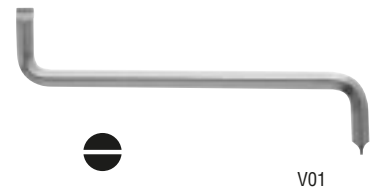

Phillips-Tip Offset Screwdrivers

- Designed for confined hard-to-reach applications.
- Two tip sizes for added convenience.

Cat. No.	Point Nos.	Overall Length	Weight (lbs.)
P120	#1 and #2	4-3/4" (121 mm)	.05
P340	#3 and #4	6" (152 mm)	.20



Combination-Tip Offset Screwdriver

- Designed for confined hard-to-reach applications.
- Two tip sizes for added convenience.

Cat. No.	For Screw Nos.	Overall Length	Tip Width	Weight (lbs.)
V05	1/4" slotted #2 Phillips	5" (127 mm)	1/4" (6.3 mm)	.05

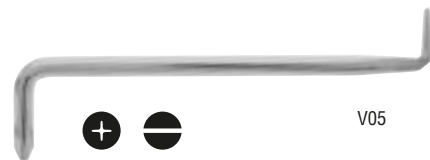

All dimensions are in inches and (millimeters).

▲WARNING: Always wear approved eye protection.

▲WARNING: NOT insulated. Will NOT protect against electrical shock.

▲WARNING: Do NOT use to pry or chisel.

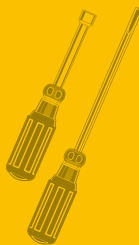

Offset Screwdrivers

2-Piece Offset Screwdriver Set

- Designed for confined hard-to-reach applications.
- Two tip sizes for added convenience.

Cat. No.	Set Contains	Weight (lbs.)
210122	P120 (No. 1 and No. 2 Phillips-tip) and V02 (1/4" to 5/16" slotted tip)	.10

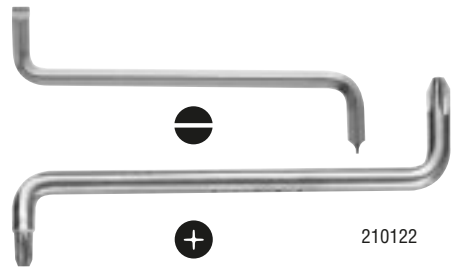

210122

Specialty Driver Set

Reversible Impact-Driver Set

- Rugged, hand-impact driver turns rusted, frozen, or other stubborn screws.
- Can also be used with 3/8" square-drive impact sockets.
- Internal, spring-loaded, helical design transforms the impact of a hammer blow to up to 200 ft.-lbs. of shock torque.
- Easily reverses for tightening or loosening screws.
- Constructed of high-grade alloy steel that has been heat-treated for added strength.
- Reclosable, seal-tight vinyl pouch with hang-up grommet.



70220

Cat. No.	Description	Weight (lbs.)
70220	pouched impact-driver set with 3/8"-square-drive fitting adapter for 5/16" hex bits, 4 assorted hex screwdriver bits (5/16" and 1/2" regular slotted tip, No. 2 and No. 4 Phillips-tip)	2.15
Replacement Screwdriver Bits		
70229	replacement set of 5/16"-drive screwdriver bits (5/16" and 1/2" regular slotted tip, No. 2 and No. 4 Phillips-tip) packed in reclosable, seal-tight vinyl pouch	.25

Torque Screwdrivers

Torque-Screwdriver Set

- Compact, easy to use set.
- Form-fitted storage box to keep set organized.

Cat. No.	Contains	Weight (lbs.)
57034	torque screwdriver Cat. No. 57035, 8-piece bit set Cat. No. 57036, rugged form-fitted storage box	1.0

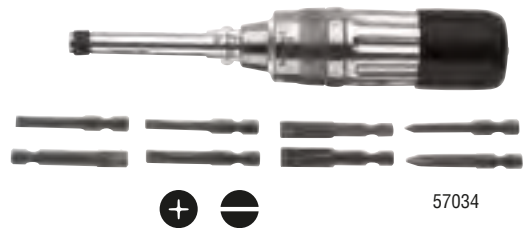

57034

Torque Screwdriver

- Adjustable, torque-limiting screwdriver with calibrated micrometer scale.
- Torqued to micrometer accuracy. Accurate to $\pm 6^\circ$ plus 1/2 graduation.
- Graduated in 2 in.-lbs. (.2 NM) increments.
- Torques either clockwise or counter-clockwise.
- Can be preset and sealed for production use.
- Meets MIL-H26497 specifications.
- Easy-release bit holder. Bits are held securely during operation, yet are easily removed when released.
- Aluminum outside construction for light weight and non-magnetic characteristics.
- Non-slip grip.
- Bits not included.



57035

Cat. No.	Range	Drive Size	Overall Length	Weight (lbs.)
57035	2-36 in.-lb.	1/4" female	8" (203 mm)	.50

8-Piece Torque-Screwdriver Bits Set

- Set of eight bits for Cat. No. 57035 torque screwdriver.

Cat. No.	Contains	Weight (lbs.)
57036	Phillips No. 1 and No. 2; slotted No. 4 (3/16" x .034"), No. 5 (7/32" x .036"), No. 6 (1/4" x .038"), No. 10 (5/16" x .046"), No. 12 (3/8" x .050); 1/4" hex-to-square male adapter	.50



57036

All dimensions are in inches and (millimeters).

⚠ WARNING: Always wear approved eye protection.

⚠ WARNING: NOT insulated. Will NOT protect against electrical shock.

⚠ WARNING: Never use on or near live electrical circuits.

⚠ WARNING: Do NOT use to pry or chisel.

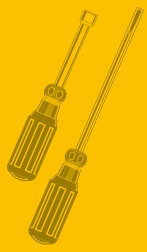

Cushion-Grip Nut Driver Sets

Features:



Tip-Ident® quickly identifies nut driver and size.

Internal flanges provide solid, twist-resistant shaft anchor.

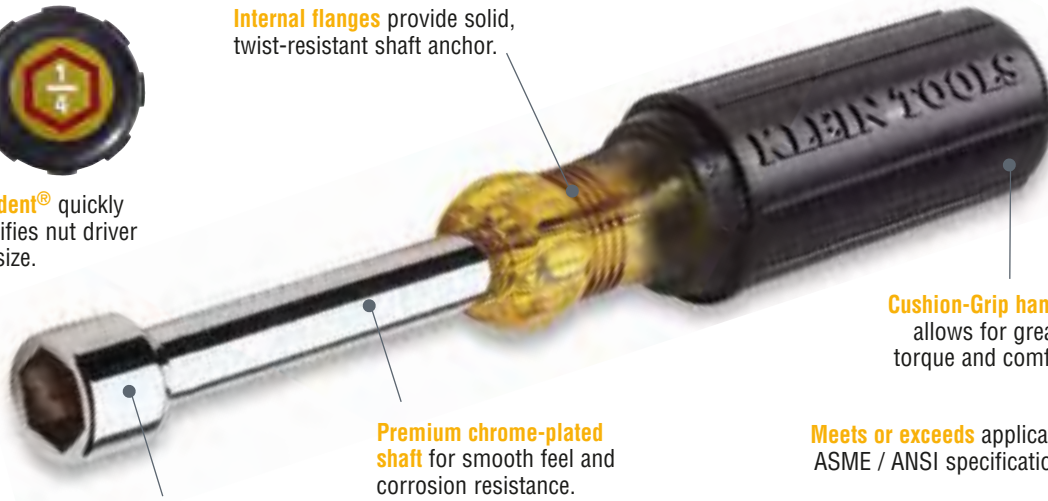

Cushion-Grip handle allows for greater torque and comfort.

Full hollow shafts facilitate work on stacked circuit boards or other long bolt applications.

Premium chrome-plated shaft for smooth feel and corrosion resistance.

Handle end is also color coded for easy identification.

Meets or exceeds applicable ASME / ANSI specifications.



7-Piece Cushion-Grip Nut Driver Set — 3" Shafts

- Set contains 630-3/16, 630-1/4, 630-5/16, 630-11/32, 630-3/8, 630-7/16, and 630-1/2. (See individual tool listings for more details.)

Cat. No.	Weight (lbs.)
631	1.50



631M

7-Piece Hollow-Shaft* Magnetic Tip Cushion-Grip Nut Driver Set — 3" Shafts

- Full hollow shaft for long bolts or studs, with magnetic tip.
- Set contains 630-3/16M, 630-1/4M, 630-5/16M, 630-11/32M, 630-3/8M, 630-7/16M, and 630-1/2M. (See individual tool listings for more details.)

Cat. No.	Weight (lbs.)
631M	1.50

*3/16" magnetic nut driver does not have hollow shaft



647M

7-Piece Cushion-Grip Nut Driver Set — 6" Shafts

- Set contains 646-3/16, 646-1/4, 646-5/16, 646-11/32, 646-3/8, 646-7/16, and 646-1/2. (See individual tool listings for more details.)

Cat. No.	Weight (lbs.)
647	1.55



7-Piece Cushion-Grip Hollow-Shaft* Magnetic Tip Nut Driver Set — 6" Shafts

- Full hollow shaft for long bolts or studs, with magnetic tip.
- Set contains 646-3/16M, 646-1/4M, 646-5/16M, 646-11/32M, 646-3/8M, 646-7/16M, 646-1/2M. (See individual tool listings for more details.)

Cat. No.	Weight (lbs.)
647M	1.55

*3/16" magnetic nut driver does not have hollow shaft



All dimensions are in inches and (millimeters).

WARNING: Always wear approved eye protection.

WARNING: NOT insulated. Will NOT protect against electrical shock.

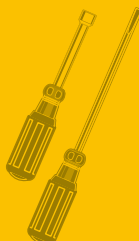

Cushion-Grip Nut Driver Sets

4-Piece Cushion-Grip Nut Driver Set

Additional Features:

- Set contains: 630-1/4, 630-5/16, 630-3/8, 630-9/16.
(See individual tool listings for more details.)

Cat. No.	Set Contains					Weight (lbs.)
633						1.30
Cat. No.	Color Code	Hex Size	Shaft Length	Overall Length		
630-1/4	red	1/4"	3" (76 mm)	6-3/4" (171 mm)		
630-5/16	yellow	5/16"	3" (76 mm)	6-3/4" (171 mm)		
630-3/8	blue	3/8"	3" (76 mm)	6-3/4" (171 mm)		
630-9/16	orange	9/16"	4" (102 mm)	9-3/8" (238 mm)		



633

2-Piece Cushion-Grip Stubby Nut Driver Set — 1-1/2" Shafts

Additional Features:

- Full hollow shaft for long bolts or studs.
- Stubby nut drivers allow for work in close quarters.
- Cat. No. 610M features magnetic tips.

Cat. No.	Set Contains				
610					
Cat. No.	Color Code	Hex Size	Shaft Length	Overall Length	
610-1/4	red	1/4"	1-1/2" (38 mm)	3-1/2" (89 mm)	
610-5/16	yellow	5/16"	1-1/2" (38 mm)	3-1/2" (89 mm)	

Cat. No.	Set Contains				
610M					
Cat. No.	Color Code	Hex Size	Shaft Length	Overall Length	
610-1/4M	red	1/4"	1-1/2" (38 mm)	3-1/2" (89 mm)	
610-5/16M	yellow	5/16"	1-1/2" (38 mm)	3-1/2" (89 mm)	



610

2-Piece Magnetic Tip Cushion-Grip Nut Driver Sets

Additional Features:

- General purpose selection of the most frequently used nut drivers.
(See individual tool listings for more details.)

Cat. No.	Set Contains		Weight (lbs.)
630M	630-1/4M, 630-5/16M		.40
646M	646-1/4M, 646-5/16M		.50



630M

7-Piece Metric Cushion-Grip Nut Driver Set — 3" Shafts

Additional Features:

- Standard length for most applications.
- Fits over long bolts and studs.

Cat. No.	Set Contains					Weight (lbs.)
65160						1.50
Cat. No.	Color Code	Hex Size Metric	Shaft Length	Overall Length		
630-5mm	black	5 mm	3" (76 mm)	6-3/4" (171 mm)		
630-5.5mm	brown	5.5 mm	3" (76 mm)	6-3/4" (171 mm)		
630-6mm	red	6 mm	3" (76 mm)	6-3/4" (171 mm)		
630-7mm	orange	7 mm	3" (76 mm)	6-3/4" (171 mm)		
630-8mm	yellow	8 mm	3" (76 mm)	6-3/4" (171 mm)		
630-9mm	green	9 mm	3" (76 mm)	6-3/4" (171 mm)		
630-10mm	blue	10 mm	3" (76 mm)	6-3/4" (171 mm)		



65160

All dimensions are in inches and (millimeters).

⚠WARNING: Always wear approved eye protection.

⚠WARNING: NOT insulated. Will NOT protect against electrical shock.

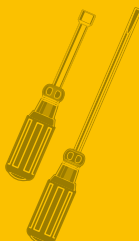

Cushion-Grip Nut Drivers

Cushion-Grip Stubby Nut Drivers — 1-1/2" Shafts

Additional Features:

- Full hollow shaft for long bolts or studs.
- Stubby nut drivers allow for work in close quarters.
- Meets or exceeds applicable ASME / ANSI specifications.



610-5/16

Cat. No.	Color Code	Hex Size	Shaft Length	Overall Length	Weight (lbs.)
610-1/4	red	1/4"	1-1/2" (38 mm)	3-1/2" (89 mm)	.10
610-5/16	yellow	5/16"	1-1/2" (38 mm)	3-1/2" (89 mm)	.10

Cushion-Grip Hollow-Shaft Nut Drivers — 3" Shafts



Additional Features:

- Standard length for most applications.
- Fits over long bolts and studs.

630-1/2

Cat. No.	Color Code	Hex Size	Shaft Length	Overall Length	Weight (lbs.)
630-3/16	black	3/16"	3" (76 mm)	6-3/4" (171 mm)	.20
630-1/4	red	1/4"	3" (76 mm)	6-3/4" (171 mm)	.20
630-5/16	yellow	5/16"	3" (76 mm)	6-3/4" (171 mm)	.20
630-11/32	green	11/32"	3" (76 mm)	6-3/4" (171 mm)	.20
630-3/8	blue	3/8"	3" (76 mm)	6-3/4" (171 mm)	.20
630-7/16	brown	7/16"	3" (76 mm)	7-5/16" (186 mm)	.25
630-1/2	red	1/2"	3" (76 mm)	7-5/16" (186 mm)	.25
630-9/16	orange	9/16"	4" (102 mm)	9-3/8" (238 mm)	.35
630-5/8	yellow	5/8"	4" (102 mm)	9-3/8" (238 mm)	.35

Refer to the insulated section for insulated nut drivers.

Metric Cushion-Grip Hollow-Shaft Nut Drivers — 3" Shafts



Additional Features:

- Standard length for most applications.
- Fits over long bolts and studs.

630-11mm

Cat. No.	Color Code	Hex Size Metric	Shaft Length	Overall Length	Weight (lbs.)
630-4mm	red	4 mm	3" (76 mm)	6-3/4" (171 mm)	.20
630-4.5mm	yellow	4.5 mm	3" (76 mm)	6-3/4" (171 mm)	.20
630-5mm	black	5 mm	3" (76 mm)	6-3/4" (171 mm)	.20
630-6mm	red	6 mm	3" (76 mm)	6-3/4" (171 mm)	.20
630-7mm	orange	7 mm	3" (76 mm)	6-3/4" (171 mm)	.20
630-8mm	yellow	8 mm	3" (76 mm)	6-3/4" (171 mm)	.20
630-10mm	blue	10 mm	3" (76 mm)	6-3/4" (171 mm)	.20
630-11mm	brown	11 mm	3" (76 mm)	7-5/16" (186 mm)	.20

Cushion-Grip Hollow-Shaft Nut Drivers — 6" Shafts

Additional Features:

- Reaches into deep recesses.
- Fits over extra-long bolts and studs.



646-1/2

Cat. No.	Color Code	Hex Size	Shaft Length	Overall Length	Weight (lbs.)
646-3/16	black	3/16"	6" (152 mm)	9-3/4" (248 mm)	.25
646-1/4	red	1/4"	6" (152 mm)	9-3/4" (248 mm)	.25
646-5/16	yellow	5/16"	6" (152 mm)	9-3/4" (248 mm)	.25
646-11/32	green	11/32"	6" (152 mm)	9-3/4" (248 mm)	.25
646-3/8	blue	3/8"	6" (152 mm)	9-3/4" (248 mm)	.30

Cat. No.	Color Code	Hex Size	Shaft Length	Overall Length	Weight (lbs.)
646-7/16	brown	7/16"	6" (152 mm)	10-5/16" (262 mm)	.35
646-1/2	red	1/2"	6" (152 mm)	10-5/16" (262 mm)	.35
646-9/16	orange	9/16"	6" (152 mm)	11-3/8" (289 mm)	.40
646-5/8	yellow	5/8"	6" (152 mm)	11-3/8" (289 mm)	.40

All dimensions are in inches and (millimeters).

⚠WARNING: Always wear approved eye protection.

⚠WARNING: NOT insulated. Will NOT protect against electrical shock.

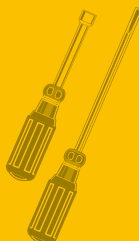

Cushion-Grip Nut Drivers

Magnetic Tip Nut Drivers – Hollow Shafts*

Additional Feature:

- Exclusive hollow shaft* design with Rare Earth magnetic tip features unobstructed pass-through, even on long bolts.

Cat. No.	Color Code	Hex Size	Shaft Length	Overall Length	Weight (lbs.)
610-1/4M	red	1/4"	3" (76 mm)	1-1/2" (89 mm)	.10
610-5/16M	yellow	5/16"	3" (76 mm)	1-1/2" (89 mm)	.10
610-3/8M	blue	3/8"	3" (76 mm)	1-1/2" (89 mm)	.10
630-3/16M*	black	3/16"	3" (76 mm)	6-3/4" (171 mm)	.20
630-1/4M	red	1/4"	3" (76 mm)	6-3/4" (171 mm)	.20
630-5/16M	yellow	5/16"	3" (76 mm)	6-3/4" (171 mm)	.20
630-11/32M	green	11/32"	3" (76 mm)	6-3/4" (171 mm)	.20
630-3/8M	blue	3/8"	3" (76 mm)	6-3/4" (171 mm)	.20
630-7/16M	brown	7/16"	3" (76 mm)	7-5/16" (186 mm)	.25
630-1/2M	red	1/2"	3" (76 mm)	7-5/16" (186 mm)	.25
646-3/16M*	black	3/16"	6" (152 mm)	9-3/4" (248 mm)	.25



630-3/8M

Cat. No.	Color Code	Hex Size	Shaft Length	Overall Length	Weight (lbs.)
646-1/4M	red	1/4"	6" (152 mm)	9-3/4" (248 mm)	.25
646-5/16M	yellow	5/16"	6" (152 mm)	9-3/4" (248 mm)	.25
646-11/32M	green	11/32"	6" (152 mm)	9-3/4" (248 mm)	.25
646-3/8M	blue	3/8"	6" (152 mm)	9-3/4" (248mm)	.30
646-7/16M	brown	7/16"	6" (152 mm)	10-5/16" (262 mm)	.35
646-1/2M	red	1/2"	6" (152 mm)	10-5/16" (262 mm)	.35
618-1/4M	red	1/4"	18" (457 mm)	21-3/4" (552 mm)	.50
618-5/16M	yellow	5/16"	18" (457 mm)	21-3/4" (552 mm)	.50

*3/16" magnetic nut driver does not have a hollow shaft.

Drive-A-Matic Cushion-Grip Nut Driver



632

Additional Features:

- Automatically fits 15 different nut and screw sizes.
- Hex head adjusts to the proper size as you turn it.
- Will drive or loosen hex nuts from 1/4" (6.4 mm) to 7/16" (11.1 mm), hex-head screws from No. 6 to 1/4" (6.4 mm), and socket-head cap screws from No. 8 to 5/16" (7.9 mm).

Cat. No.	Overall Length	Weight (lbs.)
632	7" (178 mm) when open, 6-3/4" (171 mm) when closed	.35

Coated Hollow-Shaft Nut Drivers



640-1/2

Additional Features:

- Entire shaft plastic coated for circuit protection only. NOT INSULATED.
- Special plastic coating resists cutting, cracking and chipping.
- Thin coating permits use in confined areas.

Cat. No.	Color Code	Hex Size	Shaft Length	Overall Length	Weight (lbs.)
640-3/16	black	3/16"	3" (76 mm)	6-3/4" (171 mm)	.25
640-1/4	red	1/4"	3" (76 mm)	6-3/4" (171 mm)	.25
640-5/16	yellow	5/16"	3" (76 mm)	6-3/4" (171 mm)	.25
640-3/8	blue	3/8"	3" (76 mm)	6-3/4" (171 mm)	.25
640-7/16	brown	7/16"	3" (76 mm)	7-5/16" (186 mm)	.30
640-1/2	red	1/2"	3" (76 mm)	7-5/16" (186 mm)	.25
640-9/16	orange	9/16"	4" (102 mm)	9-3/8" (238 mm)	.40
640-5/8	yellow	5/8"	4" (102 mm)	9-3/8" (238 mm)	.40

⚠ WARNING: NOT insulated. Coating is intended for protection of circuits only.



All dimensions are in inches and (millimeters).

⚠ WARNING: Always wear approved eye protection.

⚠ WARNING: NOT insulated. Will NOT protect against electrical shock.

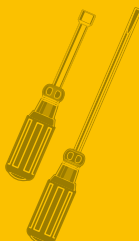

Plastic-Handle, Hollow-Shaft Nut Driver Sets

Features:

Meets or exceeds applicable ASME / ANSI specifications.

Smooth Comfordome® handles fit the palm of the hand comfortably.

Chrome-plated shaft helps prevent corrosion.

Hollow shafts facilitate work on stacked circuit boards or other long bolt applications.

Internal flanges provide solid, twist-resistant shaft anchor.

Handles are color-coded for easy identification.

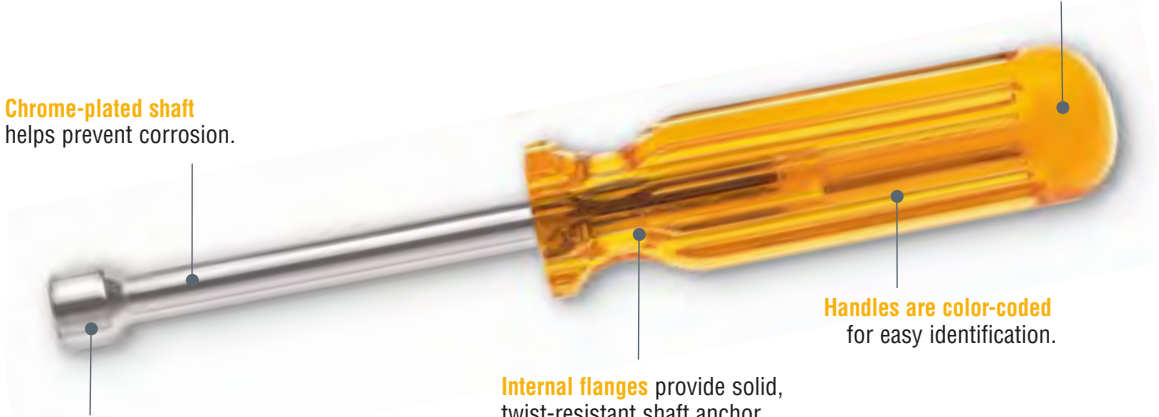

4-Piece Nut Driver Set — 3" Shafts

Additional Feature:

- Standard length works for most applications.

Cat. No.	Set Contains	Weight (lbs.)
70084		.60

Cat. No.	Handle Color	Hex Size	Shaft Length	Overall Length
S8	red	1/4"	3" (76 mm)	6-5/8" (168 mm)
S10	amber	5/16"	3" (76 mm)	6-5/8" (168 mm)
S11	green	11/32"	3" (76 mm)	6-5/8" (168 mm)
S12	blue	3/8"	3" (76 mm)	6-5/8" (168 mm)



70084

5-Piece Nut Driver Set — 3" Shafts

Additional Features:

- Standard length works for most applications.
- Comes in a hang-up box.

Cat. No.	Set Contains	Weight (lbs.)
89969		.70

Cat. No.	Handle Color	Hex Size	Shaft Length	Overall Length
S6	black	3/16"	3" (76 mm)	6-5/8" (168 mm)
S8	red	1/4"	3" (76 mm)	6-5/8" (168 mm)
S10	amber	5/16"	3" (76 mm)	6-5/8" (168 mm)
S11	green	11/32"	3" (76 mm)	6-5/8" (168 mm)
S12	blue	3/8"	3" (76 mm)	6-5/8" (168 mm)



89969

All dimensions are in inches and (millimeters).

WARNING: Always wear approved eye protection.

WARNING: NOT insulated. Will NOT protect against electrical shock.

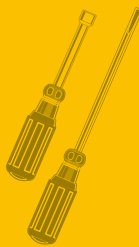

Plastic-Handle, Hollow Shaft Nut Driver Sets

7-Piece Nut Driver Set — 3" Shafts

Additional Feature:

- Set contains seven hollow-shaft nut drivers in the most popular hex sizes.

Cat. No.	Set Contains	Weight (lbs.)
89004		1.10

Cat. No.	Handle Color	Hex Size	Shaft Length	Overall Length
S6	black	3/16"	3" (76 mm)	6-5/8" (168 mm)
S8	red	1/4"	3" (76 mm)	6-5/8" (168 mm)
S10	amber	5/16"	3" (76 mm)	6-5/8" (168 mm)
S11	green	11/32"	3" (76 mm)	6-5/8" (168 mm)
S12	blue	3/8"	3" (76 mm)	6-5/8" (168 mm)
S14	brown	7/16"	3" (76 mm)	7" (178 mm)
S16	red	1/2"	3" (76 mm)	7" (178 mm)



89004

7-Piece Nut Driver Set — 3" Shafts

Additional Features:

- Set contains seven hollow-shaft nut drivers in the most popular hex sizes.
- Convenient vinyl pouch hangs up or rolls up.

Cat. No.	Set Contains	Weight (lbs.)
K7		1.15

Cat. No.	Handle Color	Hex Size	Shaft Length	Overall Length
S6	black	3/16"	3" (76 mm)	6-5/8" (168 mm)
S8	red	1/4"	3" (76 mm)	6-5/8" (168 mm)
S10	amber	5/16"	3" (76 mm)	6-5/8" (168 mm)
S11	green	11/32"	3" (76 mm)	6-5/8" (168 mm)
S12	blue	3/8"	3" (76 mm)	6-5/8" (168 mm)
S14	brown	7/16"	3" (76 mm)	7" (178 mm)
S16	red	1/2"	3" (76 mm)	7" (178 mm)



K7

7-Piece Nut Driver Set With Metal Stand — 3" Shafts

Additional Features:

- Set contains seven hollow-shaft nut drivers in the most popular hex sizes.
- Metal holder stands freely or hangs on wall.

Cat. No.	Set Contains	Weight (lbs.)
S700		1.60

Cat. No.	Handle Color	Hex Size	Shaft Length	Overall Length
S6	black	3/16"	3" (76 mm)	6-5/8" (168 mm)
S8	red	1/4"	3" (76 mm)	6-5/8" (168 mm)
S10	amber	5/16"	3" (76 mm)	6-5/8" (168 mm)
S11	green	11/32"	3" (76 mm)	6-5/8" (168 mm)
S12	blue	3/8"	3" (76 mm)	6-5/8" (168 mm)
S14	brown	7/16"	3" (76 mm)	7" (178 mm)
S16	red	1/2"	3" (76 mm)	7" (178 mm)



S700

All dimensions are in inches and (millimeters).

⚠WARNING: Always wear approved eye protection.

⚠WARNING: NOT insulated. Will NOT protect against electrical shock.

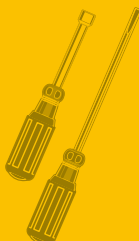

Plastic-Handle, Hollow Shaft Nut Driver Sets

10-Piece Metric Nut Driver Set With Stand — 3" Shafts

Additional Features:

- White enameled metal stand holds all ten 3"-shaft metric nut drivers.
- Identification label makes individual size selection easy.

Cat. No.	Set Contains				Weight (lbs.)
70200					1.85
Cat. No.	Handle Color	Hex Size	Shaft Length	Overall Length	
70204	black	4 mm	3" (76 mm)	6-5/8" (168 mm)	
70245	black	4.5 mm	3" (76 mm)	6-5/8" (168 mm)	
70205	black	5 mm	3" (76 mm)	6-5/8" (168 mm)	
70255	black	5.5 mm	3" (76 mm)	6-5/8" (168 mm)	
70206	black	6 mm	3" (76 mm)	6-5/8" (168 mm)	
70207	black	7 mm	3" (76 mm)	6-5/8" (168 mm)	
70208	black	8 mm	3" (76 mm)	6-5/8" (168 mm)	
70209	black	9 mm	3" (76 mm)	6-5/8" (168 mm)	
70210	black	10 mm	3" (76 mm)	7" (178 mm)	
70211	black	11 mm	3" (76 mm)	7" (178 mm)	



70200



7-Piece Nut Driver Set — 6" Shafts

Additional Feature:

- Contains seven 6"-shaft nut drivers that reach into deep recesses.

Cat. No.	Set Contains				Weight (lbs.)
89904					1.15
Cat. No.	Handle Color	Hex Size	Shaft Length	Overall Length	
S66	black	3/16"	6" (152 mm)	9-5/8" (244 mm)	
S86	red	1/4"	6" (152 mm)	9-5/8" (244 mm)	
S106	amber	5/16"	6" (152 mm)	9-5/8" (244 mm)	
S116	green	11/32"	6" (152 mm)	9-5/8" (244 mm)	
S126	blue	3/8"	6" (152 mm)	9-5/8" (244 mm)	
S146	brown	7/16"	6" (152 mm)	10" (254 mm)	
S166	red	1/2"	6" (152 mm)	10" (254 mm)	



89904



Plastic-Handle, Hollow Shaft Nut Drivers

Stubby Nut Drivers — 1-1/2" Shafts

Additional Feature:

- Stubby nut drivers allow for work in close quarters.

Cat. No.	Handle Color	Hex Size	Shaft Length	Overall Length	Weight (lbs.)
SS8	red	1/4"	1-1/2" (38 mm)	3-3/4" (95 mm)	.15
SS10	amber	5/16"	1-1/2" (38 mm)	3-3/4" (95 mm)	.15
SS12	blue	3/8"	1-1/2" (38 mm)	3-3/4" (95 mm)	.15



SS10



All dimensions are in inches and (millimeters).

⚠WARNING: Always wear approved eye protection.

⚠WARNING: NOT insulated. Will NOT protect against electrical shock.

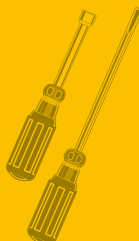

Plastic-Handle Nut Drivers

Hollow-Shaft Nut Drivers — 3" & 4" Shafts



Additional Features:

- Standard length works for most applications.
- Fits over long bolts and studs.

Cat. No.	Handle Color	Hex Size	Shaft Length	Overall Length	Weight (lbs.)
S5	amber	5/32"	3" (76 mm)	6-1/2" (165 mm)	.10
S6	black	3/16"	3" (76 mm)	6-5/8" (168 mm)	.10
S7	brown	7/32"	3" (76 mm)	6-5/8" (168 mm)	.10
S8	red	1/4"	3" (76 mm)	6-5/8" (168 mm)	.15
S9	orange	9/32"	3" (76 mm)	6-5/8" (168 mm)	.15
S10	amber	5/16"	3" (76 mm)	6-5/8" (168 mm)	.15
S11	green	11/32"	3" (76 mm)	6-5/8" (168 mm)	.15
S12	blue	3/8"	3" (76 mm)	6-5/8" (168 mm)	.15
S14	brown	7/16"	3" (76 mm)	7" (178 mm)	.20
S16	red	1/2"	3" (76 mm)	7" (178 mm)	.20
S18	red	9/16"	4" (102 mm)	8-1/2" (216 mm)	.30
S20	red	5/8"	4" (102 mm)	8-1/2" (216 mm)	.30

Metric Nut Drivers — 3" Shafts



Additional Features:

- Standard length works for most applications.
- Fits over long bolts and studs.

Cat. No.	Handle Color	Hex Size	Shaft Length	Overall Length	Weight (lbs.)
70204	black	4 mm	3" (76 mm)	6-5/8" (168 mm)	.10
70245	black	4.5 mm	3" (76 mm)	6-5/8" (168 mm)	.10
70205	black	5 mm	3" (76 mm)	6-5/8" (168 mm)	.15
70255	black	5.5 mm	3" (76 mm)	6-5/8" (168 mm)	.15
70206	black	6 mm	3" (76 mm)	6-5/8" (168 mm)	.15
70207	black	7 mm	3" (76 mm)	6-5/8" (168 mm)	.15
70208	black	8 mm	3" (76 mm)	6-5/8" (168 mm)	.15
70209	black	9 mm	3" (76 mm)	6-5/8" (168 mm)	.15
70210	black	10 mm	3" (76 mm)	7" (178 mm)	.15
70211	black	11 mm	3" (76 mm)	7" (178 mm)	.20

Nut Drivers — 6" Shafts



Additional Features:

- Reaches into deep recesses.
- Fits over extra-long bolts and studs.

Cat. No.	Handle Color	Hex Size	Shaft Length	Overall Length	Weight (lbs.)
S66	black	3/16"	6" (152 mm)	9-5/8" (244 mm)	.15
S86	red	1/4"	6" (152 mm)	9-5/8" (244 mm)	.15
S106	amber	5/16"	6" (152 mm)	9-5/8" (244 mm)	.15
S116	green	11/32"	6" (152 mm)	9-5/8" (244 mm)	.15
S126	blue	3/8"	6" (152 mm)	9-5/8" (244 mm)	.15
S146	brown	7/16"	6" (152 mm)	10" (254 mm)	.20

Magnetic Nut Drivers — Solid Shafts

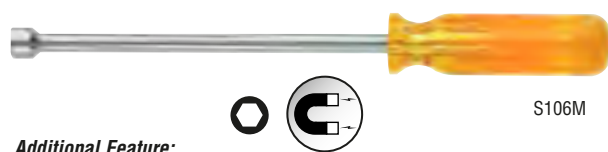

Additional Feature:

- Powerful nut-holding magnet built into solid shaft.

Cat. No.	Handle Color	Hex Size	Shaft Length	Overall Length	Weight (lbs.)
S8M	red	1/4"	3" (76 mm)	6-5/8" (168 mm)	.15
S10M	amber	5/16"	3" (76 mm)	6-5/8" (168 mm)	.15
S86M	red	1/4"	6" (152 mm)	9-5/8" (244 mm)	.15
S106M	amber	5/16"	6" (152 mm)	9-5/8" (244 mm)	.15
S126M	blue	3/8"	6" (152 mm)	9-5/8" (244 mm)	.15
S818M	red	1/4"	18" (457 mm)	21-5/8" (549 mm)	.25
S1018M	amber	5/16"	18" (457 mm)	21-5/8" (549 mm)	.25

Super-Long Nut Drivers — 18" Shafts



Additional Features:

- Heavy-duty, long-reach nut drivers.
- Ideal for reaching into walls and other hard-to-reach places where added length is necessary.
- Available in magnetic and non-magnetic tip.
- Overall Length: 21-5/8" (549 mm).

Cat. No.	Handle Color	Hex Size	Shaft Length	Type	Weight (lbs.)
S818	red	1/4"	18" (457 mm)	standard	.25
S818M	red	1/4"	18" (457 mm)	magnetic	.25
S1018	amber	5/16"	18" (457 mm)	standard	.25
S1018M	amber	5/16"	18" (457 mm)	magnetic	.25

All dimensions are in inches and (millimeters).

⚠WARNING: Always wear approved eye protection.

⚠WARNING: NOT insulated. Will NOT protect against electrical shock.

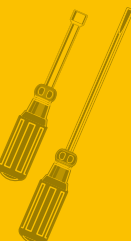

Tapping Tools and Awls

Cushion-Grip Triple Taps and 6-in-1 Tap Tool

- Quickly forms new threads, re-forms burred threads, and cleans out plaster obstructions.
- Each tap size rethreads to next larger size if threads are stripped.

Cat. No.	Tap Sizes	Overall Length	Weight (lbs.)
623-20	Triple Tap 10-24, 12-24, 1/4-20	7-3/4"	.25
623-24	Triple Tap 6-32, 8-32, 10-24	7-3/4"	.25
626	6-in-1 Tap 6-32, 8-32, 10-32, 10-24, 12-24, 1/4-20	7-3/4"	.25



626

Replacement Taps

628-20	10-24, 12-24, 1/4-20	replacement for 623-20, 626
626-24	6-32, 8-32, 10-24	replacement for 623-24
626-32	6-32, 8-32, 10-32	replacement for 623-32, 626

6-in-1 Tapping Tool



627-20

- Quickly forms new threads, re-forms burred threads, and cleans out plaster obstructions.
- Each tap size rethreads to next larger size if threads are stripped.
- Two high-carbon steel taps are secured in reversible holder.

Cat. No.	Tap Sizes	Overall Length	Weight (lbs.)
627-20	6-32, 8-32, 10-32, 10-24, 12-24, 1/4-20	7-5/8" (194 mm)	0.35

Replacement Taps

626-32	10-32, 8-32, 6-32
628-20	10-24, 12-24, 1/4-20

Triple Taps



625-24

- Quickly forms new threads, re-forms burred threads, and cleans out plaster obstructions.
- Each tap size rethreads to next larger size if threads are stripped.

Cat. No.	Tap Sizes	Color Code	Overall Length	Weight (lbs.)
625-24	6-32, 8-32, 10-24	blue	7-1/8" (181 mm)	0.20
625-32	6-32, 8-32, 10-32	orange	7-1/8" (181 mm)	0.20

Replacement Taps

626-24	for Cat. No. 625-24
626-32	for Cat. No. 625-32

Cushion-Grip Scratch Awl



650

- Professional, heavy-duty, hard-pointed awl.
- Scribes metal, starts screw holes, performs a variety of piercing and punching jobs.
- Rigid, chrome-plated, heat-treated, tempered-steel shank has full reinforcing bolster at handle for extra strength and for handle impact reinforcement.
- Internal flanges provide solid shank anchor.
- Cushion-Grip handle allows for greater comfort.

Cat. No.	Blade Length	Overall Length	Weight (lbs.)
650	3-1/2" (89 mm)	7-7/8" (200 mm)	.25

⚠WARNING: Do NOT hammer on tool.

Steel Scratch Awl



66385

- One-piece forged-steel blade and bolstered shank.
- Heat treated for long life.
- Well-balanced for top efficiency during use.
- Black finish for rust resistance.

Cat. No.	Blade Length	Overall Length	Weight (lbs.)
66385	3-1/2" (89 mm)	7" (178 mm)	.30

⚠WARNING: NOT insulated. Will NOT protect against electrical shock.

⚠WARNING: Never use on or near live electrical circuits.

All dimensions are in inches and (millimeters).

⚠WARNING: Always wear approved eye protection.

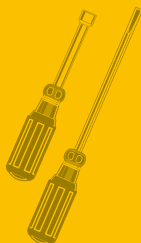

Spring Tools

Cushion-Grip Spring Tool



ST4

- Installs or removes small-diameter coil springs on motors, brake shoes, headlights, relays, installing recessed can lighting, solenoids, and hundreds of other applications.
- Great for rod and leaf springs.
- Unique C-tip prevents spring slippage.

Cat. No.	Shank Length	Overall Length	Weight (lbs.)
ST4	4" (102 mm)	7-3/4" (197mm)	.17
ST6	6" (152 mm)	9-3/4" (248 mm)	.19

Spring Tool



ST49

- Installs or removes small-diameter coil springs on motors, brake shoes, headlights, relays, can lighting, solenoids, and hundreds of other applications.
- Great for rod and leaf springs.
- Unique C-tip prevents spring slippage.

Cat. No.	Overall Length	Weight (lbs.)
ST49	7-1/2" (191 mm)	.10

Spring Tool Set

2-Piece Recessed Can Light Tool Set

- Contains the two tools needed for finishing can light installations in record time.
- Long reach, spring tool (Cat. No. ST6) makes attaching difficult springs easy.
- Compact, stubby nut driver (Cat. No. 610-1/4) even fits in smaller cans to tighten hard to reach ceiling height adjustment screws.



65020

Cat. No.	Set Contains	Weight (lbs.)												
65020	<table border="1"> <thead> <tr> <th>Cat. No.</th> <th>Description</th> <th>Shank Length</th> <th>Overall Length</th> </tr> </thead> <tbody> <tr> <td>ST6</td> <td>6" spring tool</td> <td>6" (152 mm)</td> <td>9-3/4" (248 mm)</td> </tr> <tr> <td>610-1/4</td> <td>1/4" stubby nut driver</td> <td>1-1/2" (38 mm)</td> <td>3-1/2" (89 mm)</td> </tr> </tbody> </table>	Cat. No.	Description	Shank Length	Overall Length	ST6	6" spring tool	6" (152 mm)	9-3/4" (248 mm)	610-1/4	1/4" stubby nut driver	1-1/2" (38 mm)	3-1/2" (89 mm)	.36
Cat. No.	Description	Shank Length	Overall Length											
ST6	6" spring tool	6" (152 mm)	9-3/4" (248 mm)											
610-1/4	1/4" stubby nut driver	1-1/2" (38 mm)	3-1/2" (89 mm)											

All dimensions are in inches and (millimeters).

▲WARNING: Always wear approved eye protection.

▲WARNING: NOT insulated. Will NOT protect against electrical shock.



POWER TOOL ACCESSORIES



**KLEIN
TOOLS**



Power Tool Accessories

The next generation of Klein tools is now available for use with power tools. Klein offers a line of Multi-Bit Drivers, Hollow-Shaft Nut Drivers, Power Driver Bits and Conduit Reamers available as accessories for power tools. All the same functionality, quality and performance you expect from Klein.



For Professionals... Since 1857®

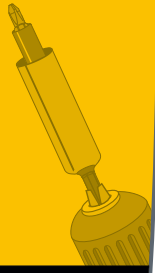

Multi-Bit Power Drivers

Klein Multi-Bit Power Drivers combine multiple screwdriver and nut driver functions in one power tool adaptor. The solid body with 1/4" hex quick connect easily attaches to any power drill. Multi-Bit Power Drivers are designed and constructed to withstand the high RPMs and force of even the most aggressive impact driver. Allowing you to quickly change between functions – No more wasting time and money, searching for different accessories in your tool bag.

- Three screwdriver functions and three nut drivers in one power tool adaptor (Cat. No. 32605).
- Solid body with 1/4" hex quick connect for easy attachment to any power drill.
- Designed and constructed to withstand impact drills.



32605

Cat. No.	Description	Screwdriver			Nut Driver				Overall Length
		PH2	SQ2	SL 3/16"	1/4"	5/16"	3/8"	9/16"	
32605	5-in-1 Multi-Bit Power Driver	+	□	●	○		○		4.25" (108 mm)
32606	6-in-1 Multi-Bit Power Driver	+	□	●	○	○		○	5.00" (127 mm)
Double-Ended Replacement Bits									
32744	Replacement Bit for 32605 (3-pack)		□	●					
32745	Replacement Bit for 32606 (3-pack)		□	●					

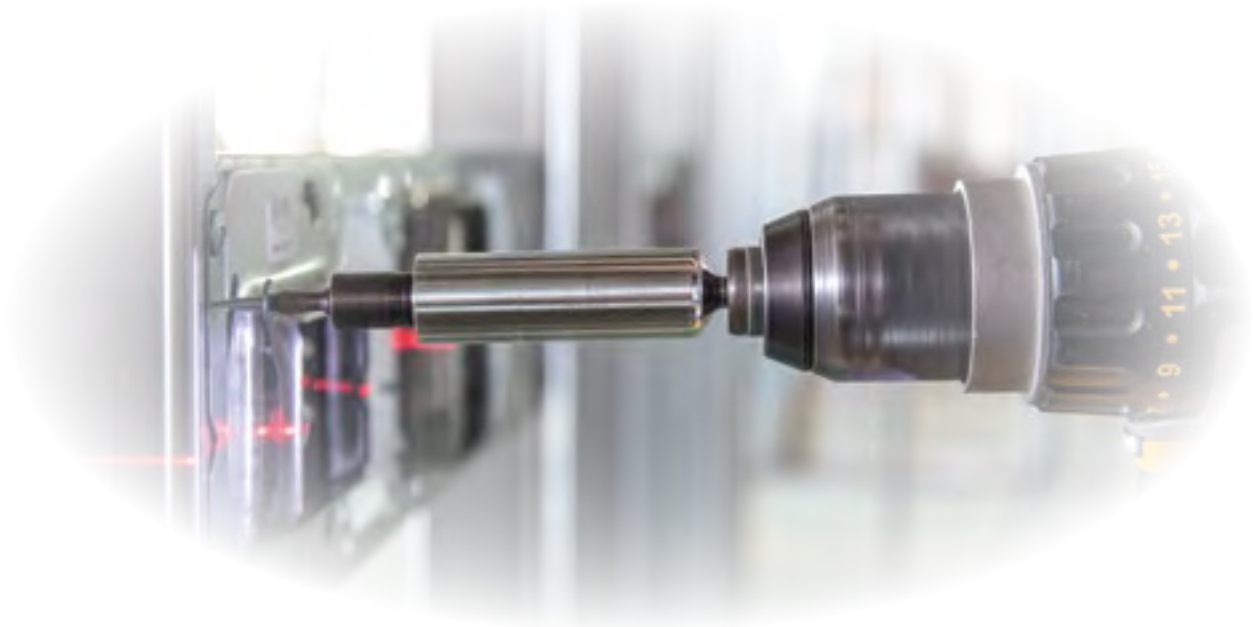

All dimensions are in inches and (millimeters).

⚠WARNING: Always wear approved eye protection.

⚠WARNING: NOT insulated. Will NOT protect against electrical shock.

⚠WARNING: Do NOT use to pry or chisel.

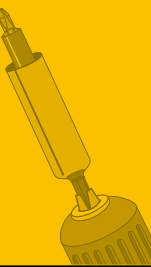

Power Drivers

Klein Power Drivers are manufactured in the U.S.A. to ensure proper fit in every application. Each Power Driver is precision machined, heat treated and finished to the gold standards Klein Tools puts into every screwdriver blade. Proprietary processes create the longest life power driver bit in the industry. Tight fitting tips reduce wear and deliver the premium performance you, and the generations before you, expect from a Klein.

- Precision machined for better fit, more torque and less wear
- Custom heat treated for long life
- Available in a variety of tips

Klein Lasts Longer Before Cam Out

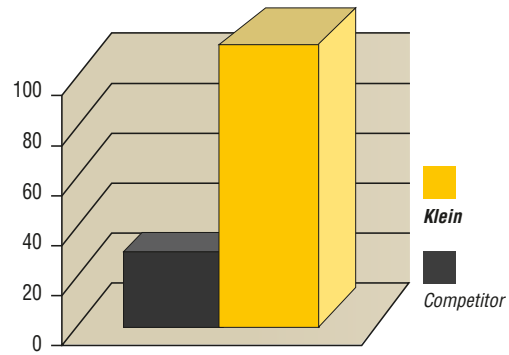

PH3-6-2



PH2-1-15

PH2-35-5

Cat. No.	Tip Size	Length	Pack Qty.
⊕ Phillips			
PH1-1-5	#1	1"	5
PH1-35-5	#1	3-1/2"	5
PH1-6-2	#1	6"	2
PH2-1-15	#2	1"	15
PH2-35-5	#2	3-1/2"	5
PH2-6-2	#2	6"	2
PH3-1-5	#3	1"	5
PH3-35-5	#3	3-1/2"	5
PH3-6-2	#3	6"	2
⊖ Slotted			
SL316-1-5	3/16"	1"	5
SL316-35-5	3/16"	3-1/2"	5
SL14-1-5	1/4"	1"	5
SL14-35-5	1/4"	3-1/2"	5

Cat. No.	Tip Size	Length	Pack Qty.
⊖ Square-Recess			
SQ1-1-5	#1	1"	5
SQ1-35-5	#1	3-1/2"	5
SQ1-6-2	#1	6"	2
SQ2-1-15	#2	1"	15
SQ2-35-5	#2	3-1/2"	5
SQ2-6-2	#2	6"	2
SQ3-1-5	#3	1"	5
SQ3-35-5	#3	3-1/2"	5
SQ3-6-2	#3	6"	2

Power Conduit Reamer

Reams conduit and installs fittings in a fraction of the time. Designed to fit into power drill chucks and quick release adapters, the power conduit reamer reduces time and wrist fatigue on projects with large quantities of conduit runs.

- Reams 1/2", 3/4" and 1" conduit in a fraction of the time.
- Includes replaceable No. 2 square recess bit for installing conduit fittings.
- Includes precision engineered replaceable reaming blade.
- Designed to fit into power drill chucks and 1/4" quick release.



85091

Cat. No.	Description
85091	conduit reamer drill head for 1/2", 3/4" and 1" conduit

Replacement Parts	
19353	conduit reamer replacement blade
SQ2-1-15	#2 square recess replacement bits (15-pack)

All dimensions are in inches and (millimeters).

⚠WARNING: Always wear approved eye protection.

⚠WARNING: NOT insulated. Will NOT protect against electrical shock.

⚠WARNING: Do NOT use to pry or chisel.



Power Nut Drivers

Available in several sizes, these hollow shaft magnetic nut drivers are designed for long bolts, studs or threaded rod jobs. The magnetic head holds nuts and bolts to aid in hard to reach installations. The 5" and 10" models feature a wrench assist end, designed for high torque loosening found in many jobs.

- 5" and 10" models are sold individually.
- Power Nut Driver Set contains 1/4", 5/16" and 3/8" nut drivers (Cat. No. 32759).



Hollow magnetic* shafts for nut running



32759



PND7165



PND71610

Cat. No.	Hex Sizes	Hollow Depth	Overall Length
2" (127 mm) Out-of-Chuck			
32759	1/4", 5/16", 3/8"	1-7/8" (48 mm)	6.32" (80 mm)
5" (127 mm) Out-of-Chuck			
PND7165	7/16"	3-13/16" (97 mm)	6.32" (161 mm)
PND125	1/2"	3-23/32" (95 mm)	6.30" (160 mm)
PND9165	9/16"	3-5/8" (92 mm)	6.33" (161 mm)
10" (254 mm) Out-of-Chuck			
PND71610	7/16"	8-13/16" (223 mm)	11.32" (288 mm)
PND1210	1/2"	8-23/32" (221 mm)	11.30" (287 mm)
PND91610	9/16"	8-5/8" (219 mm)	11.33" (288 mm)

*Rare earth magnet is globally sourced.

All dimensions are in inches and (millimeters).

▲WARNING: Always wear approved eye protection.

▲WARNING: NOT insulated. Will NOT protect against electrical shock.

▲WARNING: Do NOT use to pry or chisel.

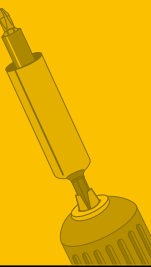



#1 Choice Among Professional Electricians

For more than 157 years, Klein Tools has manufactured the world's finest hand tools. Klein offers more than 3,000 tools and accessories, including pliers, wire strippers, screwdrivers/nut drivers, fish tapes, conduit benders, electrical testers, and more, all with a dedication to quality and innovation. Klein Tools is also committed to American manufacturing, operating seven plants in the U.S.

KLEIN TOOLS®



For Professionals... Since 1857®



www.kleintools.com



Wrenches

Klein's line of wrenches are forged from the finest steel and are designed to deliver great strength and long working life. Regardless of the job type, Klein has a wrench that will help the professional complete the task at hand.

F O R P R O F E S S I O N A L S . . . S I N C E 1 8 5 7 ®

Wrenches



Adjustable Wrenches

Features:

Precision-machined jaws are individually chosen and assembled by hand for smooth operation.

Chrome-plated for corrosion resistance.

Standard and metric scales for faster adjustment.

Knurl turns smoothly for easy operation.

Contoured handles for comfortable use.

Rail is ground for precision fit.

4-threaded knurl worm gear for improved balance.

Minimally protruding jaw shank for greater capacity in tight spaces.



Adjustable Wrenches — High Capacity

Additional Features:

- Extra capacity allows use of a smaller size wrench to handle bigger jobs, especially in confined spaces.
- Forged heat-treated alloy steel for maximum strength and light weight.



D507-8

Cat. No.	Handle Finish	Handle Color	Length	Capacity	Weight
507-6	high-polish chrome	-	6-3/8" (162 mm)	15/16" (24 mm)	0.29 lbs. (0.14 kg)
507-8	high-polish chrome	-	8-1/8" (206 mm)	1-1/8" (28 mm)	0.61 lbs. (0.28 kg)
507-10	high-polish chrome	-	10-1/8" (257 mm)	1-5/16" (33 mm)	0.98 lbs. (0.44 kg)
507-12	high-polish chrome	-	12-1/4" (311 mm)	1-1/2" (38 mm)	1.65 lbs. (0.75 kg)
D507-6	plastic dipped	transparent red	6-1/2" (165 mm)	15/16" (24 mm)	0.33 lbs. (0.15 kg)
D507-8	plastic dipped	transparent red	8-1/4" (209 mm)	1-1/8" (28 mm)	0.66 lbs. (0.30 kg)
D507-10	plastic dipped	transparent red	10-1/4" (260 mm)	1-5/16" (33 mm)	1.11 lbs. (0.50 kg)
D507-12	plastic dipped	transparent red	12-3/8" (314 mm)	1-1/2" (38 mm)	1.8 lbs. (0.81 kg)

Adjustable Wrench — Extra-Wide Jaw

Additional Features:

- Extra wide 1-1/2" jaw provides same capacity as a standard 12" adjustable wrench.
- Forged heat-treated alloy steel for maximum strength and light weight.



D509-8



Cat. No.	Handle Finish	Handle Color	Length	Capacity	Weight
D509-8	plastic dipped	solid blue	8-1/2" (216 mm)	1-1/2" (38 mm)	0.77 lbs. (0.35 kg)

All dimensions are in inches and (millimeters).

▲WARNING: Always wear approved eye protection.

▲WARNING: NOT insulated. Plastic-dipped or slip-on plastic handles are NOT intended for protection against electrical shock.

▲WARNING: Do NOT push or hammer wrench.

▲WARNING: Do NOT extend handle length.

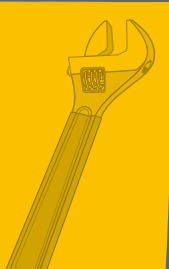

Adjustable Wrenches

Adjustable Wrenches — Standard Capacity

Additional Features:

- Forged heat-treated alloy steel for maximum strength and light weight.
- High-polish chrome finish.



506-15

Cat. No.	Handle Color	Handle Finish	Length	Capacity	Weight (lbs.)
D506-4	transparent red	plastic-dipped	4-1/2" (114 mm)	1/2" (12 mm)	.13
506-15	-	high-polish chrome	15-7/8" (403 mm)	1-11/16" (42 mm)	2.92
500-18	-	high-polish chrome	18-1/4" (463 mm)	2-1/16" (52 mm)	4.67
500-24	-	high-polish chrome	24" (610 mm)	2-1/2" (63 mm)	7.76

Adjustable-Head Construction Wrenches

- Eliminates the need to carry several fixed-size wrenches.
- Forged from select alloy steel with continuous-taper handle.
- Industrial black finish for corrosion resistance.
- Includes lanyard hole for easy tool tethering.



3239



3227

Cat. No.	Max. Size Capacity	Length	Weight (lbs.)
3227	1-5/16" (33 mm)	11" (279 mm)	1.20
3239	1-1/2" (38 mm)	16" (406 mm)	2.36

All dimensions are in inches and (millimeters).

▲WARNING: Always wear approved eye protection.

▲WARNING: Do NOT push or hammer wrench.

▲WARNING: NOT insulated. Plastic-dipped or slip-on plastic handles are NOT intended for protection against electrical shock.

▲WARNING: Do NOT extend handle length.



Combination Wrenches

Features:

Corrosion resistant.

Forged from the highest quality alloy steel.

Open-end and box wrenches have the same size opening on each end.

Open ends are offset at standard 15° angle for confined working areas.

Durable chrome-plated finish.

Box ends have 15° angle offset to provide clearance over obstructions.



7-Piece Combination Wrench Set

Cat. No.	Set Contains	Weight (lbs.)
68400		1.23

Cat. No.	Size	Length	Box End Point
68410	1/4"	5-1/8"	12
68411	5/16"	4-3/8"	12
68412	3/8"	6-1/8"	12
68413	7/16"	6-3/8"	12
68414	1/2"	7-1/8"	12
68415	9/16"	7-1/2"	12
68416	5/8"	8-1/8"	12

Includes pouch with marked pockets for each wrench



68400

9-Piece Combination Wrench Set

Cat. No.	Set Contains	Weight (lbs.)
68402		2.07

Cat. No.	Size	Length	Box End Point
68410	1/4"	5-1/8"	12
68411	5/16"	4-3/8"	12
68412	3/8"	6-1/8"	12
68413	7/16"	6-3/8"	12
68414	1/2"	7-1/8"	12
68415	9/16"	7-1/2"	12
68416	5/8"	8-1/8"	12
68417	11/16"	9"	12
68418	3/4"	9-1/8"	12

Includes pouch with marked pockets for each wrench



68402

All dimensions are in inches.

⚠ WARNING: Do NOT push or hammer wrench.

⚠ WARNING: Always wear approved eye protection.

⚠ WARNING: Do NOT extend handle length.



Combination Wrenches

12-Piece Combination Wrench Set

Cat. No.	Set Contains	Weight (lbs.)
68404		4.13

Cat. No.	Size	Length	Box End Point
68410	1/4"	5-1/8"	12
68411	5/16"	4-3/8"	12
68412	3/8"	6-1/8"	12
68413	7/16"	6-3/8"	12
68414	1/2"	7-1/8"	12
68415	9/16"	7-1/2"	12
68416	5/8"	8-1/8"	12
68417	11/16"	9"	12
68418	3/4"	9-1/8"	12
68419	13/16"	10-9/16"	12
68420	7/8"	11-1/2"	12
68421	15/16"	12-1/2"	12

Includes pouch with marked pockets for each wrench



68404

14-Piece Combination Wrench Set

Cat. No.	Set Contains	Weight (lbs.)
68406		9.75

Cat. No.	Size	Length	Box End Point
68412	3/8"	6-1/8"	12
68413	7/16"	6-3/8"	12
68414	1/2"	7-1/8"	12
68415	9/16"	7-1/2"	12
68416	5/8"	8-1/8"	12
68417	11/16"	9"	12
68418	3/4"	9-1/8"	12
68419	13/16"	10-9/16"	12
68420	7/8"	11-1/2"	12
68421	15/16"	12-1/2"	12
68422	1"	13-1/2"	12
68423	1-1/16"	14-5/8"	12
68424	1-1/8"	15-9/16"	12
68425	1-1/4"	16-7/8"	12

Includes pouch with marked pockets for each wrench



68406

Combination Wrenches

Cat. No.	Size	Length	Box End Point	Weight (lbs.)
68410	1/4"	5-1/8"	12	.05
68411	5/16"	4-3/8"	12	.05
68412	3/8"	6-1/8"	12	.10
68413	7/16"	6-3/8"	12	.14
68414	1/2"	7-1/8"	12	.18
68415	9/16"	7-1/2"	12	.23
68416	5/8"	8-1/2"	12	.28
68417	11/16"	9"	12	.37
68418	3/4"	9-7/8"	12	.46

All dimensions are in inches.

▲WARNING: Always wear approved eye protection.



68417

Cat. No.	Size	Length	Box End Point	Weight (lbs.)
68419	13/16"	10-5/8"	12	.53
68420	7/8"	11-1/2"	12	.67
68421	15/16"	12-1/2"	12	.79
68422	1"	13-1/4"	12	.93
68423	1-1/16"	14-1/4"	12	1.18
68424	1-1/8"	15-1/2"	12	1.52
68425	1-1/4"	16-3/4"	12	1.88

▲WARNING: Do NOT push or hammer wrench.

▲WARNING: Do NOT extend handle length.

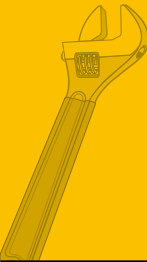

Combination Wrenches – Metric

7-Piece Combination Wrench Set — Metric

Cat. No.	Set Contains	Weight (lbs.)
68500		1.21

Cat. No.	Size	Length	Box End Point
68507	7 mm	107 mm	12
68509	9 mm	119 mm	12
68510	10 mm	135 mm	12
68511	11 mm	149 mm	12
68513	13 mm	166 mm	12
68514	14 mm	178 mm	12
68515	15 mm	191 mm	12

Includes pouch with marked pockets for each wrench



68500

11-Piece Combination Wrench Set — Metric

Cat. No.	Set Contains	Weight (lbs.)
68502		2.35

Cat. No.	Size	Length	Box End Point
68507	7 mm	107 mm	12
68508	8 mm	110 mm	12
68509	9 mm	119 mm	12
68510	10 mm	135 mm	12
68511	11 mm	149 mm	12
68512	12 mm	159 mm	12
68513	13 mm	166 mm	12
68514	14 mm	178 mm	12
68515	15 mm	191 mm	12
68517	17 mm	213 mm	12
68519	19 mm	245 mm	12

Includes pouch with marked pockets for each wrench



68502

Combination Wrenches — Metric

Cat. No.	Size	Length	Box End Point	Weight (lbs.)
68507	7 mm	130 mm	12	.05
68508	8 mm	137 mm	12	.08
68509	9 mm	155 mm	12	.10
68510	10 mm	165 mm	12	.13
68511	11 mm	165 mm	12	.13
68512	12 mm	181 mm	12	.18
68513	13 mm	181 mm	12	.16
68514	14 mm	191 mm	12	.22
68515	15 mm	191 mm	12	.22
68517	17 mm	229 mm	12	.39
68519	19 mm	248 mm	12	.42



68512

All dimensions are in inches or millimeters.

⚠ WARNING: Always wear approved eye protection.

⚠ WARNING: Do NOT push or hammer wrench.

⚠ WARNING: Do NOT extend handle length.



Open-End Wrenches

Features:

Corrosion resistant.

Forged from the highest quality alloy-steel.

Different size opening on each end of wrench.

Ends are offset at 15° angle for clearance over obstructions.

Durable chrome-plated finish.



5-Piece Open-End Wrench Set

Cat. No.	Set Contains	Weight (lbs.)	
68450		1.08	
Cat. No.	Small Size	Large Size	Length
68460	1/4"	5/16"	4-3/4"
68461	3/8"	7/16"	6"
68462	1/2"	9/16"	7"
68463	9/16"	5/8"	7-1/2"
68464	11/16"	3/4"	9"

Includes pouch with marked pockets for each wrench



68450

7-Piece Open-End Wrench Set

Cat. No.	Set Contains	Weight (lbs.)	
68452		2.46	
Cat. No.	Small Size	Large Size	Length
68460	1/4"	5/16"	4-3/4"
68461	3/8"	7/16"	6"
68462	1/2"	9/16"	7"
68463	9/16"	5/8"	7-1/2"
68464	11/16"	3/4"	9"
68465	13/16"	7/8"	10"
68466	15/16"	1"	11"

Includes pouch with marked pockets for each wrench



68452

Open-End Wrenches

Cat. No.	Small Size	Large Size	Length	Weight (lbs.)
68460	1/4"	5/16"	4-3/4"	.04
68461	3/8"	7/16"	6"	.10
68462	1/2"	9/16"	7"	.17
68463	9/16"	5/8"	7-1/2"	.20
68464	11/16"	3/4"	9"	.36
68465	13/16"	7/8"	10"	.55
68466	15/16"	1"	11"	.80



68463

All dimensions are in inches or millimeters.

▲WARNING: Always wear approved eye protection.

▲WARNING: Do NOT push or hammer wrench.

▲WARNING: Do NOT extend handle length.

Socket Wrench Sets

8-Piece 1/2-Inch Drive Deep-Socket Set



65514

Set consists of the following pieces:

- Eight 12-point deep sockets: 1/2", 9/16", 5/8", 11/16", 3/4", 13/16", 7/8", and 15/16".
- Hinged metal box.

Cat. No.	Description	Weight (lbs.)
65514	complete 8-piece 1/2" drive, deep-socket set plus metal box	4.53

16-Piece 1/2-Inch Drive Socket Wrench Set



65512

Set consists of the following pieces:

- Thirteen 12-point sockets: 7/16", 1/2", 9/16", 5/8", 11/16", 3/4", 13/16", 7/8", 15/16", 1", 1-1/16", 1-1/8", and 1-1/4".
- One extension: 5" long.
- One flex handle: 17" long.
- One ratchet.
- Hinged metal box.

Cat. No.	Description	Weight (lbs.)
65512	complete 16-piece 1/2" drive set plus metal box	9.63

12-Piece 1/2-Inch Drive Socket Wrench Set



65510

Set consists of the following pieces:

- Nine 12-point sockets: 7/16", 1/2", 9/16", 5/8", 11/16", 3/4", 13/16", 7/8", and 15/16".
- One extension: 5" long.
- One spark plug socket: 5/8".
- One ratchet.
- Hinged metal box.

Cat. No.	Description	Weight (lbs.)
65510	complete 12-piece 1/2" drive set plus metal box	5.37

8-Piece 3/8-Inch Drive Deep-Socket Set



65502

Set consists of the following pieces:

- Eight 6-point deep sockets: 3/8", 7/16", 1/2", 9/16", 5/8", 11/16", 3/4" and 13/16".
- Hinged metal box.

Cat. No.	Description	Weight (lbs.)
65502	8-piece deep-socket 3/8" drive set plus metal box	2.66

13-Piece 3/8-Inch Drive Socket Set – Metric

Set consists of the following pieces:

- Thirteen 6-point sockets: 7, 8, 9, 10, 11, 12, 13, 14, 15, 16, 17, 18, and 19 mm.
- Handy, flip-lock tray.

Cat. No.	Description	Weight (lbs.)
65506	13 sockets plus flip-lock tray	1.33



65506

All dimensions are in inches and (millimeters).

▲WARNING: Always wear approved eye protection.



Socket Wrench Sets

9-Piece 3/8-Inch Drive "D" Socket Wrench Set



Special tool selection for telephone work on cable enclosures and pole hardware.

Set consists of the following pieces:

- Four 6-point deep sockets: 3/8", 7/16", 1/2", and 9/16".
- One 3/8"-drive reversible ratchet: 7-7/8" long.
- Two extensions: 3" and 5" long.
- One 9/16" combination wrench: 6-5/8" long.
- One 3/16" hex nut driver.
- Hinged metal box.

65503

Cat. No.	Description	Weight (lbs.)
65503	complete 9-piece "D" wrench kit plus metal box	3.60

12-Piece 3/8-Inch Drive Socket Wrench Set



65504

Set consists of the following pieces:

- Four 6-point sockets: 3/8", 7/16", 1/2", and 9/16".
- Four 12-point sockets: 5/8", 11/16", 3/4", and 13/16".
- One spark plug socket: 5/8".
- Two extensions: 1-3/4" and 6" long.
- One ratchet.
- Hinged metal box.

Cat. No.	Description	Weight (lbs.)
65504	complete 12-piece 3/8" drive set plus metal box	3.62

20-Piece 3/8-Inch Drive Socket Wrench Set



65508

Set consists of the following pieces:

- Four 6-point sockets: 3/8", 7/16", 1/2", and 9/16".
- Five 12-point sockets: 5/8", 11/16", 3/4", 13/16", and 7/8".
- Eight 6-point deep sockets: 3/8", 7/16", 1/2", 9/16", 5/8", 11/16", 3/4", and 13/16".
- Two extensions: 1-3/4" and 3" long.
- One ratchet.
- Hinged metal box.

Cat. No.	Description	Weight (lbs.)
65508	complete 20-piece 3/8" drive set plus metal box	5.40

13-Piece 1/4-Inch Drive Socket Wrench Set



65500

Set consists of the following pieces:

- Nine 6-point sockets: 3/16", 7/32", 1/4", 9/32", 5/16", 11/32", 3/8", 7/16", and 1/2".
- One spinner handle.
- Two extensions: 2" and 6" long.
- One ratchet.
- Hinged metal box.

Cat. No.	Description	Weight (lbs.)
65500	complete 13-piece 1/4" drive set plus metal box	2.07

All dimensions are in inches and (millimeters).

⚠WARNING: Always wear approved eye protection.



Socket Wrenches

1/4-Inch Drive — Standard 6-Point Sockets

Cat. No.	Size	Weight (lbs.)
65600	3/16"	.02
65601	7/32"	.02
65602	1/4"	.02
65603	9/32"	.02
65604	5/16"	.02
65605	11/32"	.03
65606	3/8"	.04
65607	7/16"	.04
65608	1/2"	.05



1/4-Inch Drive — Deep 6-Point Sockets

Cat. No.	Size	Weight (lbs.)
65610	1/4"	.06
65611	9/32"	.06
65612	5/16"	.05
65613	11/32"	.07
65614	3/8"	.08
65615	7/16"	.09
65616	1/2"	.11



1/4-Inch Drivers and Extensions

Cat. No.	Description	Weight (lbs.)
65620	4-3/4" ratchet	.32
65621	spinner handle	.19
65622	2" extension	.05
65623	6" extension	.14



3/8-Inch Drive — Standard 12-Point Sockets

Cat. No.	Size	Weight (lbs.)
65704	5/8"	.08
65705	11/16"	.11
65706	3/4"	.12
65707	13/16"	.15
65708	7/8"	.19



3/8-Inch Drive — Standard 6-Point Sockets

Cat. No.	Size	Weight (lbs.)
65700	3/8"	.05
65701	7/16"	.05
65702	1/2"	.06
65703	9/16"	.06



3/8-Inch Drive — Metric 6-Point Sockets

Cat. No.	Size	Weight (lbs.)
65907	7 mm	.04
65908	8 mm	.04
65909	9 mm	.05
65910	10 mm	.05
65911	11 mm	.05
65912	12 mm	.06
65913	13 mm	.07
65914	14 mm	.08
65915	15 mm	.10
65916	16 mm	.09
65917	17 mm	.10
65918	18 mm	.11
65919	19 mm	.14



3/8-Inch Drive — Deep 6-Point Sockets

Cat. No.	Size	Weight (lbs.)
65710	3/8"	.09
65711	7/16"	.10
65712	1/2"	.13
65713	9/16"	.15
65714	5/8"	.22
65715	11/16"	.27
65716	3/4"	.28
65717	13/16"	.34



Socket Wrenches

3/8-Inch Drivers and Extensions

Cat. No.	Description	Weight (lbs.)
65720	7-1/2" ratchet	.73
65721	1-1/2" extension	.09
65722	3" extension	.15
65723	6" extension	.30
65724	5/8" spark plug socket	.21

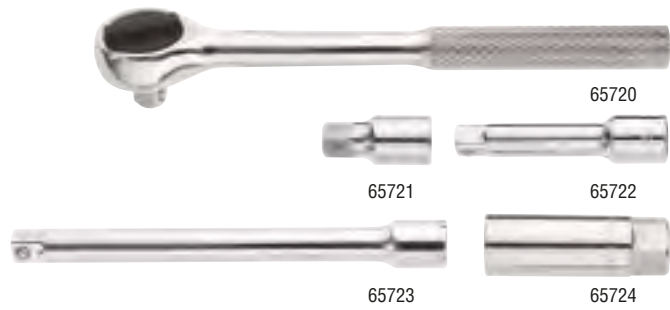

1/2-Inch Drive — Standard 12-Point Sockets

Cat. No.	Size	Weight (lbs.)
65800	7/16"	.12
65801	1/2"	.12
65802	9/16"	.12
65803	5/8"	.12
65804	11/16"	.16
65805	3/4"	.18
65806	13/16"	.19
65807	7/8"	.21
65808	15/16"	.27
65809	1"	.31
65810	1-1/16"	.36
65811	1-1/8"	.41
65812	1-1/4"	.55

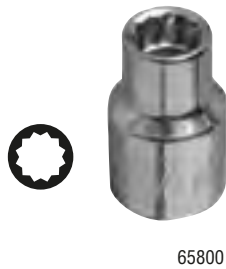

1/2-Inch Drive — Deep 12-Point Sockets

Cat. No.	Size	Weight (lbs.)
65825	1/2"	.30
65826	9/16"	.31
65827	5/8"	.24
65828	11/16"	.32
65829	3/4"	.36
65830	13/16"	.41
65831	7/8"	.41
65832	15/16"	.55



1/2-Inch Drivers and Extensions

Cat. No.	Description	Weight (lbs.)
65820	10-1/2" ratchet	1.30
65821	5" extension	.45
65822	17" flex handle	1.83
65823	5/8" spark plug socket	.18

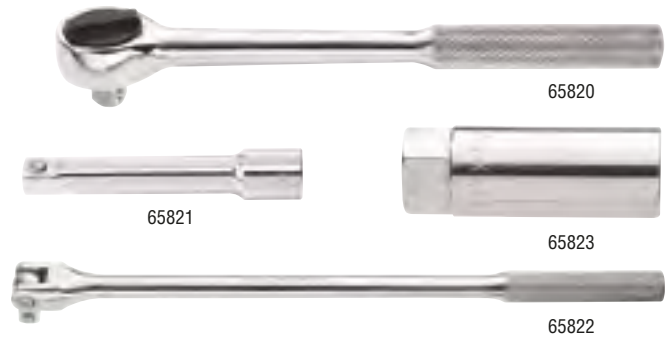

Ratcheting Box Wrenches

Features:

Different size opening on each end.

Corrosion resistant.

Durable chrome-plated finish.

For use in confined spaces and on long studs.



Laminated construction for greater strength.

Reverse ratcheting action by simply turning wrench over.



All dimensions are in inches and (millimeters).

WARNING: Always wear approved eye protection.

Ratcheting Box Wrenches

5-Piece Ratcheting Box Wrench Set

Additional Features:

- Five ratcheting box wrenches packed in a vinyl 8-1/2"W x 10"H (216 mm x 254 mm) roll-up pouch with individual pockets.
- Wrenches flip over to reverse ratchet.

Cat. No.	Set Contains	Weight (lbs.)	
68221		1.45	
Cat. No.	Point	Size	Length
68200	12	1/4" x 5/16"	4-3/8" (112 mm)
68201	12	3/8" x 7/16"	5-1/2" (140 mm)
68202	12	1/2" x 9/16"	6-7/8" (175 mm)
68203	12	5/8" x 11/16"	8-1/4" (216 mm)
68204	12	5/8" x 3/4"	8-1/4" (216 mm)



68221

7-Piece Ratcheting Box Wrench Set

Additional Feature:

- Set of the ratcheting box wrenches in vinyl roll-up pouch.

Cat. No.	Set Contains	Weight (lbs.)	
68222		2.65	
Cat. No.	Point	Size	Length
68200	12	1/4" x 5/16"	4-3/8" (112 mm)
68201	12	3/8" x 7/16"	5-1/2" (140 mm)
68202	12	1/2" x 9/16"	6-7/8" (175 mm)
68203	12	5/8" x 11/16"	8-1/4" (216 mm)
68204	12	5/8" x 3/4"	8-1/4" (216 mm)
68205	12	11/16" x 3/4"	9-1/4" (235 mm)
68206	12	13/16" x 7/8"	9-1/4" (235 mm)



68222

Ratcheting Box Wrenches



68201

Cat. No.	Point	Size	Length	Weight (lbs.)
68200	12	1/4" x 5/16"	4-3/8" (112 mm)	.13
68201	12	3/8" x 7/16"	5-1/2" (140 mm)	.18
68202	12	1/2" x 9/16"	6-7/8" (175 mm)	.29
68203	12	5/8" x 11/16"	8-1/4" (216 mm)	.43

Cat. No.	Point	Size	Length	Weight (lbs.)
68204	12	5/8" x 3/4"	8-1/4" (216 mm)	.42
68205	12	11/16" x 3/4"	9-1/4" (235 mm)	.52
68206	12	13/16" x 7/8"	9-1/4" (235 mm)	.69

3-Piece Fully Reversible Ratcheting Offset Box Wrench Set

- Set of three offset and fully reversible ratcheting box wrenches.
- Different size single-hex openings on each end.
- Includes heavy-duty vinyl pouch.

Cat. No.	Set Contains	Weight (lbs.)	
68244		.61	
Cat. No.	Point	Size	Length
68234	6	1/4" x 5/16"	4-3/8" (112 mm)
68236	6	3/8" x 7/16"	5-1/2" (140 mm)
68238	6	1/2" x 9/16"	6-3/4" (171 mm)



68244

All dimensions are in inches and (millimeters).

▲WARNING: Always wear approved eye protection.

▲WARNING: Do NOT use on or near live electrical circuits.

▲WARNING: Do NOT push or hammer wrench.

▲WARNING: Do NOT extend handle length.

Ratcheting Offset Box Wrenches

5-Piece Fully Reversible Ratcheting Offset Box Wrench Set

- Set of the offset reversible ratchet box wrenches in vinyl roll-up pouch.
- Two grommet holes for hanging.

Cat. No.	Set Contains	Weight (lbs.)
68245		1.57

Cat. No.	Point	Size	Length
68234	6	1/4" x 5/16"	4-3/8" (112 mm)
68236	6	3/8" x 7/16"	5-1/2" (140 mm)
68238	6	1/2" x 9/16"	6-3/4" (171 mm)
68240	12	5/8" x 11/16"	8-1/8" (206 mm)
68242	12	3/4" x 7/8"	9-1/8" (232 mm)



68245

Fully Reversible Ratcheting Offset Box Wrenches

- Both ends are offset 25° for more convenient use in confined spaces.
- Quick-flip reversing lever for instant ratchet reversal.
- Laminated construction for greater strength.
- Chrome-plated for rust resistance.
- Different size openings at each end.

Cat. No.	Point	Size	Length	Weight (lbs.)
68234	6	1/4" x 5/16"	4-3/8" (112 mm)	.13
68236	6	3/8" x 7/16"	5-1/2" (140 mm)	.18
68238	6	1/2" x 9/16"	6-3/4" (171 mm)	.30
68240	12	5/8" x 11/16"	8-1/8" (206 mm)	.46
68242	12	3/4" x 7/8"	9-1/8" (232 mm)	.50



68236

Ratcheting Refrigeration Wrenches

- Fully reversible ratchet wrenches designed for refrigeration-packing gland nuts and valve stem sockets.
- Wrenches are compact in size, with clearly marked sockets for four nut sizes.
- Also designed for beam-clamp installation.
- Quick-flip reversing lever permits instant ratchet reversal.
- Wrenches are ruggedly built and have polished chrome finish with smooth edges for comfort.



68310

Cat. No.	Socket Sizes	Length	Weight (lbs.)
68309	3/16" and 1/4" sq. x 1/2" and 9/16" hex	6-13/16" (173 mm)	.43
68310	3/16" and 5/16" sq. x 1/4" and 3/8" sq.	5-1/2" (140 mm)	.20
68310-24	24 pack of Cat. No. 68310	5-1/2" (140 mm)	4.70

Specialty Wrenches

Can Wrench

- Two tools in one; saves space in your pouch.
- One end opens telephone box fasteners, the other end tightens nuts on binding-post terminals.
- The 7/16" socket has a black finish and the 3/8" socket has a silver finish.
- Sockets are 1-1/4" (32 mm) deep to fit over long binding posts and are thin-walled for easy access into tight areas.
- Socket ends are color-coded for quick identification of socket sizes.
- Hex-socket design enables using a wrench to obtain extra torque.
- High-impact, break-resistant handle for long and dependable service.
- Sockets are heat-treated, alloy steel.



68005

Cat. No.	Description	Length	Handle Dia.	Weight (lbs.)
68005	3/8" and 7/16" hex nut	7" (178 mm)	1" (25 mm)	.35

⚠WARNING: NOT insulated. Will NOT protect against electrical shock.

All dimensions are in inches and (millimeters).

⚠WARNING: Always wear approved eye protection.

⚠WARNING: Do NOT push or hammer wrench.

⚠WARNING: Do NOT use on or near live electrical circuits.

⚠WARNING: Do NOT extend handle length.



Specialty Wrenches

Bell System Type

- Similar to standard lineman's wrench, but with end openings sized to NEMA hardware specifications.
- Silver painted finish.



3146B

Cat. No.	Description	Length	Weight (lbs.)
3146B	Large end has 1-1/16" and 1-3/16" openings. Small end has 11/16" and 7/8" openings.	13" (330 mm)	1.76

Lineman's Wrenches

- Forged from special bar steel and heat-treated for long life.
- Each end has two different size openings.
- Hole is provided at larger end for turning-in standard pole steps.
- Wrench is suited for use on heavy three-bolt guy clamps on which clearance is limited.
- Dark blue painted finish (small end is painted silver on Cat. No. 3146A).



3146

Cat. No.	Description	Length	Weight (lbs.)
3146	For 5/8" hardware. Large end has 29/32" and 1-3/32" openings. Small end has 5/8" and 13/16" openings.	13" (330 mm)	1.85
3146A	For 3/4" hardware. Large end has 1-1/16" and 1-5/16" openings. Small end has 5/8" and 7/8" openings.	13" (330 mm)	1.70

3-in-1 Impact Socket – Distribution | Transmission

- NRHD Distribution socket features three square socket sizes: 3/4", 1", and 1-1/8".
- NRHD2 Transmission socket features three square socket sizes: 1-1/8", 1-5/16", and 1-1/2".
- 7/16" hex quick-change adapter included.
- Fine-tuned ball detent provides improved retention, minimizing drops.
- Long hollow shaft allows use on long threaded bolts.



NRHD



NRHD2

Cat. No.	Description	Length	Weight (lbs.)
NRHD	3-in-1 Impact Socket	7-3/4" (197 mm)	2.0
NRHD2	11" (279.4 mm)	3.25 lbs. (1.47 kg)	3.25 NEW!

Impact Socket Adapters

- 7/16" hex quick-change adapter.
- Fine-tuned ball detent provides improved retention, minimizing drops.
- Do not exceed 200 ft. lbs of torque.



NRHDA



NRHDA2

Cat. No.	Description	Length	Weight (oz.)
NRHDA	Distribution Socket Adapter	7/16"	5.8
NRHDA2	Transmission Socket Adapter	7/16"	10.9 NEW!

Lineman's Ratcheting Wrenches

- Bolt-through design allows bolts to pass through the socket.
- 3/4" and 1" x 1-1/8" combination square socket for most common utility hardware.
- Bright yellow socket for easy visibility.
- Works on most common utility pole hardware, such as lag bolts, "C" clamps and suspension bolts.
- KT155T and KT155HD also offer two popular wrench sizes: 9/16" and 3/4".
- Heavy duty design (KT155HD).



KT151T



KT155HD



KT155T

Cat. No.	Description	Length	Weight (lbs.)
KT151T	Ratcheting Lineman's Wrench	13" (330 mm)	2.12
KT155HD	Ratcheting Lineman's Wrench – Heavy Duty	12" (305 mm)	2.10
KT155T	5-in-1 Lineman's Wrench	9-3/8" (238 mm)	1.42

All dimensions are in inches and (millimeters).

⚠WARNING: Always wear approved eye protection.

⚠WARNING: Do NOT push or hammer wrench.

⚠WARNING: NOT insulated. Plastic-dipped or slip-on plastic handles are NOT intended for protection against electrical shock.

⚠WARNING: Do NOT extend handle length.



Specialty Wrenches

Lineman's 4-in-1 Box Wrenches

- Chrome plated finish resists corrosion.
- "See-through" insulating handle confirms metal ends are not connected (Cat. No. KT223X4-INS).
- 1/2", 9/16", 5/8" and 3/4" sizes in one tool; 12-point sockets.
- Reverse ratcheting action by reversing switches on each end of the wrench.
- Textured grooves in handle prevent slipping.
- Solid, one piece design (Cat. No. KT223X4).



KT223X4-INS

KT223X4

Cat. No.	Description	Socket Size	Length	Weight (lbs.)
KT223X4-INS	Insulating Lineman's Box Wrench	1/2", 9/16", 5/8" & 3/4"	9" (229 mm)	.70
KT223X4	Lineman's Ratcheting Box Wrench	1/2", 9/16", 5/8" & 3/4"	9" (229 mm)	.70

Construction Wrenches

Adjustable-Head Construction Wrenches

- Eliminates the need for carrying several fixed-size wrenches.
- Forged from select alloy steel with continuous taper handle for aligning bolt and/or rivet holes.
- Industrial black finish for corrosion resistance.
- Includes lanyard hole for easy tool tethering.



3239

Cat. No.	Max. Size Capacity	Length	Weight (lbs.)
3239	1-1/2" (38 mm)	16" (406 mm)	2.36
3227	1-5/16" (33 mm)	11" (279 mm)	1.20

1/2"-Drive Ratcheting Construction Wrench

- Accepts 1/2" square-drive hex socket.
- Reversible ratchet.
- Eliminates the need for carrying several fixed-size wrenches.
- Forged from select alloy steel with continuous taper handle for aligning bolt and/or rivet holes.
- Industrial black finish for corrosion resistance.



3238

Cat. No.	Overall Length	Weight (lbs.)
3238	15" (381 mm)	2.10

Erection Wrenches

- Forged from select alloy steel to withstand high-leverage and heavy loads.
- Extra-heavy-duty head area gives maximum strength and durability.
- Continuous taper of handle makes lining-up bolt holes easy and works on a range of bolt-hole sizes without binding.
- Extra-large hub area works on larger diameter holes better than other wrenches.
- Catalog number, bolt size and nominal opening size are stamped on every wrench for easy identification.
- American Bridge design.



3231

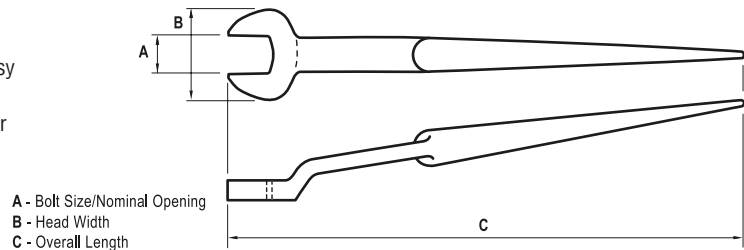

Cat. No.	Nut Type	Bolt Size	Nom. Opening	Head Width	Taper Diameter	Overall Length	Weight (lbs.)
3210	U.S. heavy	1/2"	7/8"	2-1/4"	7/8" to 3/16"	14-3/4"	1.36
3211	U.S. heavy	5/8"	1-1/16"	2-1/4"	7/8" to 3/16"	14-3/4"	1.31
3212	U.S. heavy	3/4"	1-1/4"	2-1/2"	1" to 1/4"	16-5/8"	1.98
3213	U.S. heavy	7/8"	1-7/16"	3"	1-1/8" to 9/32"	17-3/8"	2.72
3214	U.S. heavy	1"	1-5/8"	3-5/8"	1-1/8" to 1/4"	18"	3.36
3219	U.S. regular	1/2"	3/4"	2-1/4"	7/8" to 8/16"	14-3/4"	1.36
3220	U.S. regular	1/2"	13/16"	2-1/4"	7/8" to 3/16"	14-3/4"	1.35

Cat. No.	Nut Type	Bolt Size	Nom. Opening	Head Width	Taper Diameter	Overall Length	Weight (lbs.)
3221	U.S. regular	5/8"	1"	2-1/4"	7/8" to 3/16"	14-3/4"	1.31
3222	U.S. regular	3/4"	1-1/8"	2-1/2"	1" to 1/4"	16-5/8"	2.00
3223	U.S. regular	7/8"	1-5/16"	3"	1-1/8" to 9/32"	17-3/8"	2.87
3224	U.S. regular	1"	1-1/2"	3-5/8"	1-1/8" to 1/4"	18"	3.37
3231	utility	5/8"	15/16"	2-1/4"	7/8" to 3/16"	14-3/4"	1.31
3232	utility	3/4"	1-1/16"	2-1/2"	1" to 1/4"	16-5/8"	2.00

All dimensions are in inches and (millimeters).

WARNING: Always wear approved eye protection.

WARNING: Do NOT push or hammer wrench.

WARNING: Do NOT extend handle length.



Strap Wrenches

Grip-It® Strap Wrenches

- Completely adjustable strap wrench.
- Works in the tightest quarters.
- Urethane-covered, high-strength belting attached to lightweight, I-beam handle.
- Patented, cam-action design permits uniform, high-torque application.
- Under normal conditions, will not scratch, damage or deform polished pipe and fittings, plastic pipe and fittings, oil and water filters, glass pipe, PVC conduit, or polished shafts.
- Also works on alternator belts, flywheels, and propeller assemblies.



S12H

Cat. No.	Handle Length	Diameter Capacity, O.D.	Weight (lbs.)
S6H	6" (152 mm)	1-1/2" - 5" (38 mm - 127 mm)	.20
S12H	12" (305 mm)	1-1/2" - 5" (38 mm - 127 mm)	.80
S18H	18" (457 mm)	1-1/8" - 8" (28 mm - 228 mm)	2.95

Torque Wrenches

Micro-Adjustable Torque-Sensing Wrenches with Square-Drive Ratchet Head

- Automatically limits desired torque.
- "Torque by feel." Pull and click—it's torqued to micrometer accuracy.
- Ratchet head allows speedy torquing and operation in confined working areas.
- Torques to the right.



57005

Cat. No.	Drive Size	Range	Length	Weight (lbs.)
57000	3/8"	15 - 75 ft-lb (20.4 - 101.7 Nm)	14-1/8" (359 mm)	2.00
57005	3/8"	30 - 150 in-lb (3.4 - 16.9 Nm)	10-5/8" (270 mm)	1.20
57010	1/2"	50 - 250 ft-lb (67.8 - 339.0 Nm)	24-1/4" (616 mm)	3.65

Master Electrician's Torque Tool Kit

- Two micrometer-adjustable torque wrenches.
- Nine hex-wrench bits.
- Two 7/16" hex-wrench extensions.
- One 7/16" female hex-wrench adaptor (Coupler).
- One hex-to-square adapter for wrenches and one adaptor for screwdrivers.
- One adjustable torque screwdriver.
- Seven screwdriver bits; five slotted, two Phillips.
- Hinged metal box.
- Additional torque screwdrivers available in screwdriver section.

Cat. No.	Description	Weight (lbs.)
57060	master electrician's torque tool kit	9.55



57060

All dimensions are in inches and (millimeters).

▲WARNING: Always wear approved eye protection.

▲WARNING: Do NOT push or hammer wrench.

▲WARNING: Do NOT extend handle length.

Hex-Key Wrenches

Klein hex-keys are the tools professionals cannot afford to be without. Heat-treated and tempered for superior strength and durability, Klein hex-keys are designed for a precise fit in sockets, preventing slippage and stripping of the socket.



F O R P R O F E S S I O N A L S . . . S I N C E 1 8 5 7 ®

Hex-Key Wrenches



Journeyman™ T-Handle Hex-Keys

Features:

Tip-Ident® sizes marked

JOURNEYMAN™

Blade-through handle design for high torque applications.

T-handle design delivers maximum power.

Soft touch grips for maximum control and comfort.

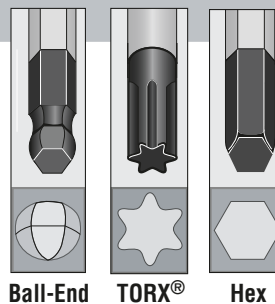

Ball-End

TORX®

Hex

Chamfered end for ease of use.

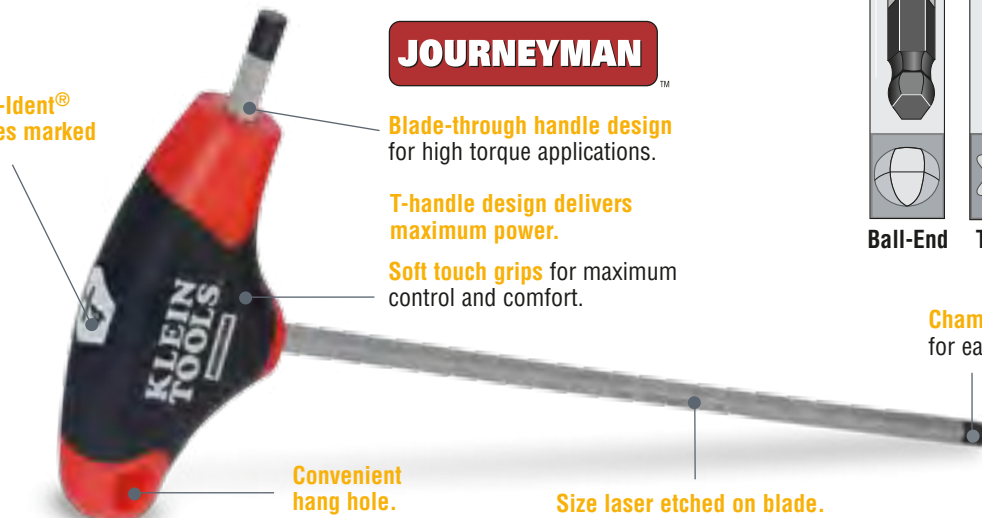

Convenient hang hole.

Size laser etched on blade.

T-Handle Ball-End Hex-Key Set with Stand – Inch

Additional features

- Metal stand for convenient hanging, storage on bench or wall.
- Short blade-through handle provides maximum tool versatility.

6" Length

Cat. No.	Set Contains	Weight (lbs.)
JTH610EB		3.0
Cat. No.	Hex Size	Blade Length
JTH6E06BE	3/32"	6" (152 mm)
JTH6E07BE	7/64"	6" (152 mm)
JTH6E08BE	1/8"	6" (152 mm)
JTH6E09BE	9/64"	6" (152 mm)
JTH6E10BE	5/32"	6" (152 mm)
JTH6E11BE	3/16"	6" (152 mm)
JTH6E12BE	7/32"	6" (152 mm)
JTH6E13BE	1/4"	6" (152 mm)
JTH6E14BE	5/16"	6" (152 mm)
JTH6E15BE	3/8"	6" (152 mm)



JTH610EB

T-Handle Ball-End Hex-Keys – Inch

Additional features

- Short blade-through handle provides maximum tool versatility.
- Black oxide tips for precision fit.

6" Length

Cat. No.	Hex Size	Blade Length	Weight (lbs.)
JTH6E06BE	3/32"	6" (152 mm)	.04
JTH6E07BE	7/64"	6" (152 mm)	.05
JTH6E08BE	1/8"	6" (152 mm)	.06
JTH6E09BE	9/64"	6" (152 mm)	.07
JTH6E10BE	5/32"	6" (152 mm)	.12
JTH6E11BE	3/16"	6" (152 mm)	.14



JTH6E13BE

Cat. No.	Hex Size	Blade Length	Weight (lbs.)
JTH6E12BE	7/32"	6" (152 mm)	.17
JTH6E13BE	1/4"	6" (152 mm)	.27
JTH6E14BE	5/16"	6" (152 mm)	.35
JTH6E15BE	3/8"	6" (152 mm)	.45
JTH6E17BE	1/2"	6" (152 mm)	.70

▲WARNING: Always wear approved eye protection.

▲WARNING: Do NOT use a pipe or similar extension to increase leverage.

▲WARNING: NOT insulated. Will NOT protect against electrical shock.

T-Handle Hex-Key Sets with Stand – Inch

Additional features

- Metal stand for convenient mounting on bench or wall.
- Short blade-through handle provides maximum tool versatility.

4" Length

Cat. No.	Set Contains	Weight (lbs.)
JTH410E		2.7

Cat. No.	Hex Size	Blade Length
JTH4E06	3/32"	4" (102 mm)
JTH4E07	7/64"	4" (102 mm)
JTH4E08	1/8"	4" (102 mm)
JTH4E09	9/64"	4" (102 mm)
JTH4E10	5/32"	4" (102 mm)
JTH4E11	3/16"	4" (102 mm)
JTH4E12	7/32"	4" (102 mm)
JTH4E13	1/4"	4" (102 mm)
JTH4E14	5/16"	4" (102 mm)
JTH4E15	3/8"	4" (102 mm)

6" Length

Cat. No.	Set Contains	Weight (lbs.)
JTH610E		2.7

Cat. No.	Hex Size	Blade Length
JTH6E06	3/32"	6" (152 mm)
JTH6E07	7/64"	6" (152 mm)
JTH6E08	1/8"	6" (152 mm)
JTH6E09	9/64"	6" (152 mm)
JTH6E10	5/32"	6" (152 mm)
JTH6E11	3/16"	6" (152 mm)
JTH6E12	7/32"	6" (152 mm)
JTH6E13	1/4"	6" (152 mm)
JTH6E14	5/16"	6" (152 mm)
JTH6E15	3/8"	6" (152 mm)



JTH610E

9" Length

Cat. No.	Set Contains	Weight (lbs.)
JTH910E		3.56

Cat. No.	Hex Size	Blade Length
JTH9E06	3/32"	9" (229 mm)
JTH9E07	7/64"	9" (229 mm)
JTH9E08	1/8"	9" (229 mm)
JTH9E09	9/64"	9" (229 mm)
JTH9E10	5/32"	9" (229 mm)
JTH9E11	3/16"	9" (229 mm)
JTH9E12	7/32"	9" (229 mm)
JTH9E13	1/4"	9" (229 mm)
JTH9E14	5/16"	9" (229 mm)
JTH9E15	3/8"	9" (229 mm)

T-Handle Hex-Keys – Inch

Additional features

- Short blade-through handle provides maximum tool versatility.
- Black oxide tips for precision fit.



JTH6E15

4" Length

Cat. No.	Hex Size	Blade Length	Weight (oz.)
JTH4E06	3/32"	4" (102 mm)	.04
JTH4E07	7/64"	4" (102 mm)	.05
JTH4E08	1/8"	4" (102 mm)	.05
JTH4E09	9/64"	4" (102 mm)	.06
JTH4E10	5/32"	4" (102 mm)	.11
JTH4E11	3/16"	4" (102 mm)	.13
JTH4E12	7/32"	4" (102 mm)	.15
JTH4E13	1/4"	4" (102 mm)	.24
JTH4E14	5/16"	4" (102 mm)	.30
JTH4E15	3/8"	4" (102 mm)	.38
JTH4E17	1/2"	4" (102 mm)	.59

6" Length

Cat. No.	Hex Size	Blade Length	Weight (lbs.)
JTH6E06	3/32"	6" (152 mm)	.04
JTH6E07	7/64"	6" (152 mm)	.05
JTH6E08	1/8"	6" (152 mm)	.05
JTH6E09	9/64"	6" (152 mm)	.06
JTH6E10	5/32"	6" (152 mm)	.11
JTH6E11	3/16"	6" (152 mm)	.13
JTH6E12	7/32"	6" (152 mm)	.15
JTH6E13	1/4"	6" (152 mm)	.24
JTH6E14	5/16"	6" (152 mm)	.30
JTH6E15	3/8"	6" (152 mm)	.38
JTH6E17	1/2"	6" (152 mm)	.59

9" Length

Cat. No.	Hex Size	Blade Length	Weight (lbs.)
JTH9E06	3/32"	9" (229 mm)	.05
JTH9E07	7/64"	9" (229 mm)	.05
JTH9E08	1/8"	9" (229 mm)	.06
JTH9E09	9/64"	9" (229 mm)	.07
JTH9E10	5/32"	9" (229 mm)	.11
JTH9E11	3/16"	9" (229 mm)	.14
JTH9E12	7/32"	9" (229 mm)	.17
JTH9E13	1/4"	9" (229 mm)	.27
JTH9E14	5/16"	9" (229 mm)	.35
JTH9E15	3/8"	9" (229 mm)	.45
JTH9E17	1/2"	9" (229 mm)	.70

▲WARNING: Do NOT use a pipe or similar extension to increase leverage.

▲WARNING: Always wear approved eye protection.

▲WARNING: NOT insulated. Will NOT protect against electrical shock.



T-Handle Ball-End Hex-Key Set with Stand – Metric

Additional features

- Metal stand for convenient mounting on bench or wall.
- Short blade-through handle provides maximum tool versatility.

6" Length

Cat. No.	Set Contains	Weight (lbs.)
JTH68MB		2.7
Cat. No.	Hex Size	Blade Length
JTH6M2BE	2 mm	6" (152 mm)
JTH6M25BE	2.5 mm	6" (152 mm)
JTH6M3BE	3 mm	6" (152 mm)
JTH6M4BE	4 mm	6" (152 mm)
JTH6M5BE	5 mm	6" (152 mm)
JTH6M6BE	6 mm	6" (152 mm)
JTH6M8BE	8 mm	6" (152 mm)
JTH6M10BE	10 mm	6" (152 mm)



JTH68MB

T-Handle Ball-End Hex-Keys – Metric

Additional features

- Short blade-through handle provides maximum tool versatility.
- Black oxide tips for precision fit.

Cat. No.	Hex Size	Blade Length	Weight (lbs.)
JTH6M2BE	2 mm	6" (152 mm)	.04
JTH6M25BE	2.5 mm	6" (152 mm)	.05
JTH6M3BE	3 mm	6" (152 mm)	.06
JTH6M4BE	4 mm	6" (152 mm)	.07
JTH6M5BE	5 mm	6" (152 mm)	.15
JTH6M6BE	6 mm	6" (152 mm)	.19
JTH6M8BE	8 mm	6" (152 mm)	.35
JTH6M10BE	10 mm	6" (152 mm)	.48



JTH6M8BE

T-Handle Hex-Key Sets with Stand – Metric

Additional features

- Metal stand for convenient mounting on bench or wall.
- Short blade-through handle provides maximum tool versatility.

6" Length

Cat. No.	Set Contains	Weight (lbs.)
JTH68M		1.84
Cat. No.	Hex Size	Blade Length
JTH6M2	2 mm	6" (152 mm)
JTH6M25	2.5 mm	6" (152 mm)
JTH6M3	3 mm	6" (152 mm)
JTH6M4	4 mm	6" (152 mm)
JTH6M5	5 mm	6" (152 mm)
JTH6M6	6 mm	6" (152 mm)
JTH6M8	8 mm	6" (152 mm)
JTH6M10	10 mm	6" (152 mm)

9" Length

Cat. No.	Set Contains	Weight (lbs.)
JTH98M		2.14
Cat. No.	Hex Size	Blade Length
JTH9M2	2 mm	9" (229 mm)
JTH9M25	2.5 mm	9" (229 mm)
JTH9M3	3 mm	9" (229 mm)
JTH9M4	4 mm	9" (229 mm)
JTH9M5	5 mm	9" (229 mm)
JTH9M6	6 mm	9" (229 mm)
JTH9M8	8 mm	9" (229 mm)
JTH9M10	10 mm	9" (229 mm)



JTH68M

▲WARNING: Do NOT use a pipe or similar extension to increase leverage.

▲WARNING: Always wear approved eye protection.

▲WARNING: NOT insulated. Will NOT protect against electrical shock.



T-Handle Hex-Keys – Metric

Additional features

- Short blade-through handle provides maximum tool versatility.
- Black oxide tips for precision fit.

6" Length

Cat. No.	Hex Size	Blade Length	Weight (lbs.)
JTH6M2	2 mm	6" (152 mm)	.04
JTH6M25	2.5 mm	6" (152 mm)	.05
JTH6M3	3 mm	6" (152 mm)	.06
JTH6M4	4 mm	6" (152 mm)	.07
JTH6M5	5 mm	6" (152 mm)	.15
JTH6M6	6 mm	6" (152 mm)	.17
JTH6M8	8 mm	6" (152 mm)	.35
JTH6M10	10 mm	6" (152 mm)	.48



JTH6M8

9" Length

Cat. No.	Hex Size	Blade Length	Weight (oz.)
JTH9M2	2 mm	9" (229 mm)	.05
JTH9M25	2.5 mm	9" (229 mm)	.06
JTH9M3	3 mm	9" (229 mm)	.07
JTH9M4	4 mm	9" (229 mm)	.10
JTH9M5	5 mm	9" (229 mm)	.18
JTH9M6	6 mm	9" (229 mm)	.23
JTH9M8	8 mm	9" (229 mm)	.42
JTH9M10	10 mm	9" (229 mm)	.48

T-Handle Hex-Key Set with Stand – TORX®

Additional features

- Metal stand for convenient mounting on bench or wall.
- Short blade-through handle provides maximum tool versatility.

Cat. No.	Set Contains	Weight (lbs.)
JTH67T		1.32

Cat. No.	Hex Size	Blade Length
JTH6T10	T10	6" (152 mm)
JTH6T15	T15	6" (152 mm)
JTH6T20	T20	6" (152 mm)
JTH6T25	T25	6" (152 mm)
JTH6T27	T27	6" (152 mm)
JTH6T30	T30	6" (152 mm)
JTH6T40	T40	6" (152 mm)



JTH67T

T-Handle Hex-Keys – TORX®

Additional features

- Short blade-through handle provides maximum tool versatility.
- Black oxide tips for precision fit.

Cat. No.	Hex Size	Blade Length	Weight (lbs.)
JTH6T10	T10	6" (152 mm)	.05
JTH6T15	T15	6" (152 mm)	.06
JTH6T20	T20	6" (152 mm)	.07
JTH6T25	T25	6" (152 mm)	.13
JTH6T27	T27	6" (152 mm)	.16
JTH6T30	T30	6" (152 mm)	.18
JTH6T40	T40	6" (152 mm)	.29



JTH6T40

TORX® is a trademark of Acument Intellectual Properties, LLC.

▲WARNING: Do NOT use a pipe or similar extension to increase leverage.

▲WARNING: Always wear approved eye protection.

▲WARNING: NOT insulated. Will NOT protect against electrical shock.



Folding Hex-Key Sets

Hex-Key Sets

- Two key positions (straight-out or right angle) for extra leverage.
- Hex ends are square-cut for a secure full-depth fit and maximum contact with the hex socket to prevent slippage and stripping of the socket.
- Handy sets fit in your pocket or tool box easily and help eliminate the lost key problem.



70579

Cat. No.	Description	Handle Length	Key Lengths	Weight (lbs.)
Hex-Key Sets – Inch				
70591	nine-key inch set: 5/64", 3/32", 7/64", 1/8", 9/64", 5/32", 3/16", 7/32", 1/4"	4-1/4" (108 mm)	1-3/4" – 3-1/2" (44 mm – 89 mm)	.50
70581	eight-key inch set: .050", 1/16", 5/64", 3/32", 7/64", 1/8", 9/64", 5/32"	3-1/16" (78 mm)	1-1/2" – 2-3/8" (38 mm – 60 mm)	.20
70583	eight-key inch set: 3/32", 7/64", 1/8", 9/64", 5/32", 3/16", 7/32", 1/4"	5-1/4" (133 mm)	3-3/8" – 4-5/8" (86 mm – 117 mm)	.65
70579	five-key inch set: 3/16", 7/32", 1/4", 5/16", 3/8"	5-1/4" (133 mm)	3" – 4-5/8" (76 mm – 117 mm)	.85
Hex-Key Sets – Metric				
70582	seven-key metric set: 1.5 mm, 2 mm, 2.5 mm, 3 mm, 4 mm, 5 mm, 6 mm	92 mm (3-5/8")	41 mm – 76 mm (1-5/8" – 3")	.35
70580	five-key metric set: 4 mm, 5 mm, 6 mm, 8 mm, 10 mm	133 mm (5-1/4")	82 mm – 117 mm (3-1/4" – 4-5/8")	.85

Grip-It® Hex-Key Sets

- Blades rotate independently up to 270°.
- Precision fit so hex tool end reduces stripping problems. Keys are industrial strength, impact-resistant and tested for performance to below freezing.
- Glass-reinforced nylon handle.
- Hex ends are square-cut for a secure full-depth fit and maximum contact with the hex socket to prevent slippage and stripping of the socket (Cat. Nos. 70570, 70573, 70574, and 70575).
- Ball design allows for a thicker neck diameter increasing torque capacity, while maintaining operational angles to 25% (Cat. Nos. 70571 and 70572).



70570

Cat. No.	Description	Sizes	Color	Weight (lbs.)
70570	Grip-It® hex sets – 5 inch sizes	3/16", 7/32", 1/4", 5/16", 3/8"	yellow	.58
70571	Grip-It® ball hex set – 5 inch sizes	3/16", 7/32", 1/4", 5/16", 3/8"	yellow	.58
70572	Grip-It® ball hex set – 5 metric sizes	5 mm, 6 mm, 7 mm, 8 mm, 10 mm	red	.58
70573	Grip-It® hex sets – 6 inch sizes and 6 metric sizes	5/64", 3/32", 7/64", 1/8", 9/64", 5/32", 1.5 mm, 2 mm, 2.5 mm, 3 mm, 4 mm, 5 mm	blue	.30
70574	Grip-It® hex sets – 9 inch sizes	5/64", 3/32", 7/64", 1/8", 9/64", 5/32", 3/16", 7/32", 1/4"	yellow	.33
70575	Grip-It® hex sets – 9 inch sizes	.050", 1/16", 5/64", 3/32", 7/64", 1/8", 9/64", 5/32", 3/16"	yellow	.20

TORX® Set

Folding TORX® Set

- TORX® drive cuts slippage, saves fasteners, efficiently transmits more torque to the work.
- Keys are tough, heat-treated chrome-nickel alloy steel for strength and durability.
- Keys fold flat into handle.
- Can be used straight out or at an angle for extra leverage.

Cat. No.	Handle Length	Blade Lengths	Contains	Weight (lbs.)
70586	4-1/4" (108 mm)	2-1/8" to 3" (54 mm to 76 mm)	T10, T15, T20, T25, T27, T30, T40	.30

TORX® is a trademark of Acument Intellectual Properties, LLC.



70586

▲WARNING: Always wear approved eye protection.

▲WARNING: Do NOT use a pipe or similar extension to increase leverage.

▲WARNING: NOT insulated. Will NOT protect against electrical shock.

L-Style Hex-Key Sets

Features:

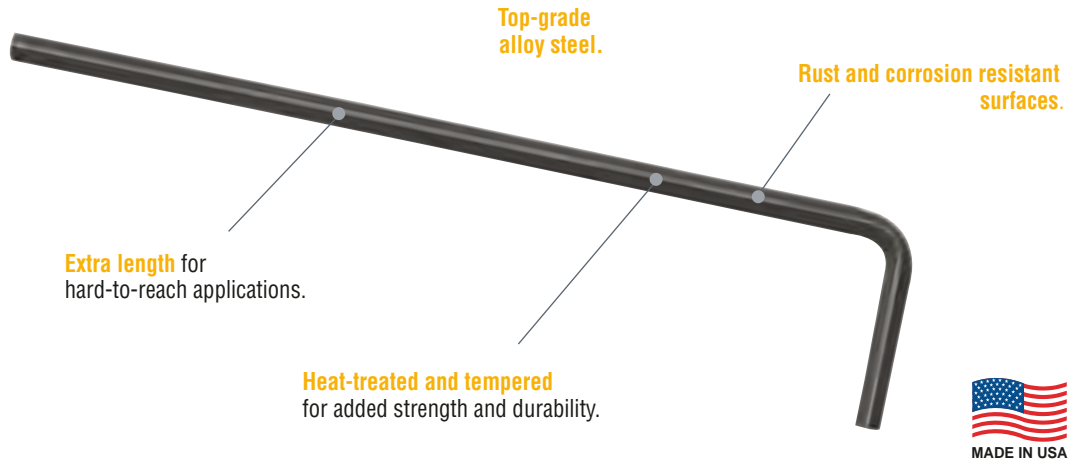

L-Style Ball-End Hex-Key Caddy Sets

Additional Features:

- L-style hex-keys organized in convenient, durable caddy sets.
- Each set contains a unique locking feature and marked slots for each key.
- Ball-end works on angles up to 30°.



12-Piece Ball-End Hex-Key Set – Inch

Cat. No.	Set Contains	Weight (lbs.)
BLK12		.53

Cat. No.	Hex Size	Size and Length	
		Short Arm Length	Long Arm Length
BL2	.050"	19/32"	2-29/32"
BL4	1/16"	5/8"	3-1/16"
BL5	5/64"	21/32"	3-1/4"
BL6	3/32"	23/32"	3-7/16"
BL7	7/64"	3/4"	3-5/8"
BL8	1/8"	13/16"	3-13/16"
BL9	9/64"	27/32"	4"
BL10	5/32"	29/32"	4-3/16"
BL12	3/16"	1"	4-15/32"
BL14	7/32"	1-3/32"	4-7/8"
BL16	1/4"	1-3/16"	5-5/16"
BL20	5/16"	1-5/16"	6"



BLK12

9-Piece Ball-End Hex-Key Set – Metric

Cat. No.	Set Contains	Weight (lbs.)
BLMK10		.62

Cat. No.	Hex Size	Size and Length	
		Short Arm Length	Long Arm Length
BLM15	1.5 mm	1/2"	3"
BLM2	2 mm	5/16"	3-3/16"
BLM25	2.5 mm	2/32"	3-7/16"
BLM3	3 mm	23/32"	3-27/32"
BLM4	4 mm	29/32"	4-1/16"
BLM5	5 mm	1-1/32"	4-17/32"
BLM6	6 mm	1-3/16"	5-13/32"
BLM8	8 mm	1-11/32"	6-5/32"
BLM10	10 mm	1-1/2"	6-17/32"

▲WARNING: Do NOT use a pipe or similar extension to increase leverage.

▲WARNING: Always wear approved eye protection.

▲WARNING: NOT insulated. Will NOT protect against electrical shock.



L-Style Hex-Key Sets

L-Style Hex-Key Caddy Sets

Additional Features:

- L-style hex-keys organized in convenient, durable caddy sets.
- Caddy contains a unique locking feature and marked slots for each key.



12-Piece Hex-Key Set – Inch

Cat. No.	Set Contains	Weight (lbs.)	
LLK12		.54	
Size and Length			
Cat. No.	Hex Size	Short Arm Length	Long Arm Length
LL2	.050"	5/8"	2-15/16"
LL4	1/16"	21/32"	3-3/32"
LL5	5/64"	11/16"	3-9/32"
LL6	3/32"	3/4"	3-15/32"
LL7	7/64"	25/32"	3-21/32"
LL8	1/8"	27/32"	3-27/32"
LL9	9/64"	7/8"	4-1/32"
LL10	5/32"	15/16"	4-7/32"
LL12	3/16"	1-1/32"	4-1/2"
LL14	7/32"	1-1/8"	4-29/32"
LL16	1/4"	1-7/32"	5-11/32"
LL20	5/16"	1-11/32"	6-1/32"



9-Piece Hex-Key Set – Metric

Cat. No.	Set Contains	Weight (lbs.)	
LMK10		.63	
Size and Length			
Cat. No.	Hex Size	Short Arm Length	Long Arm Length
LLM15	1.5 mm	23/32"	3-1/8"
LLM2	2 mm	7/16"	3-1/32"
LLM25	2.5 mm	1/2"	3-9/32"
LLM3	3 mm	9/16"	3-1/2"
LLM4	4 mm	11/16"	3-31/32"
LLM5	5 mm	13/16"	4-3/8"
LLM6	6 mm	15/16"	4-27/32"
LLM8	8 mm	1-1/32"	5-1/32"
LLM10	10 mm	1-3/32"	5-9/32"

LLK12

L-Style Hex-Keys

L-Style Ball-End Hex-Keys

Additional Features:

- Allows easy access, even in restricted areas.
- Long side for accessing hard-to-reach places.
- Short side for higher torque situations and low clearances.



BL8

Cat. No.	Hex Size	Size and Length		Weight (lbs.)
		Short Arm Length	Long Arm Length	
Ball-End Hex-Key – Inch				
BL2	.050"	19/32"	2-29/32"	.002
BL4	1/16"	5/8"	3-1/16"	.002
BL5	5/64"	21/32"	3-1/4"	.005
BL6	3/32"	23/32"	3-7/16"	.005
BL7	7/64"	3/4"	3-5/8"	.01
BL8	1/8"	13/16"	3-13/16"	.02
BL9	9/64"	27/32"	4"	.02
BL10	5/32"	29/32"	4-3/16"	.03
BL12	3/16"	1"	4-15/32"	.05
BL14	7/32"	1-3/32"	4-7/8"	.06
BL16	1/4"	1-3/16"	5-5/16"	.09
BL20	5/16"	1-5/16"	6"	.17
BL24	3/8"	1-7/16"	6-13/16"	.23

Cat. No.	Hex Size	Size and Length		Weight (lbs.)
		Short Arm Length	Long Arm Length	
Ball-End Hex-Key – Metric				
BLM15	1.5 mm	1/2"	3"	.01
BLM2	2 mm	5/16"	3-3/16"	.01
BLM25	2.5 mm	2/32"	3-7/16"	.01
BLM3	3 mm	23/32"	3-27/32"	.02
BLM4	4 mm	29/32"	4-1/16"	.03
BLM5	5 mm	1-1/32"	4-17/32"	.05
BLM6	6 mm	1-3/16"	5-13/32"	.08
BLM8	8 mm	1-11/32"	6-5/32"	.14
BLM10	10 mm	1-1/2"	6-17/32"	.24

▲WARNING: Do NOT use a pipe or similar extension to increase leverage.

▲WARNING: Always wear approved eye protection.

▲WARNING: NOT insulated. Will NOT protect against electrical shock.



L-Style Hex-Keys

Long-Arm Hex-Keys — Inch

Additional Features:

- Long side for accessing hard-to-reach places.
- Short side for higher torque situations and low clearances.

Cat. No.	Hex Size	Size and Length		
		Short Arm Length	Long Arm Length	Weight (lbs.)
LL2	.050"	5/8"	2-15/16"	.005
LL4	1/16"	21/32"	3-3/32"	.005
LL5	5/64"	11/16"	3-9/32"	.005
LL6	3/32"	3/4"	3-15/32"	.01
LL7	7/64"	25/32"	3-21/32"	.02
LL8	1/8"	27/32"	3-27/32"	.02
LL9	9/64"	7/8"	4-1/32"	.03
LL10	5/32"	15/16"	4-7/32"	.03
LL12	3/16"	1-1/32"	4-1/2"	.05
LL14	7/32"	1-1/8"	4-29/32"	.70
LL16	1/4"	1-7/32"	5-11/32"	.10
LL20	5/16"	1-11/32"	6-1/32"	.18
LL24	3/8"	1-15/32"	6-27/32"	.25



Long-Arm Hex-Keys — Metric

Additional Features:

- Long side for accessing hard-to-reach places.
- Short side for higher torque situations and low clearances.

Cat. No.	Hex Size	Size and Length		
		Short Arm Length	Long Arm Length	Weight (lbs.)
LLM15	1.5 mm	17/32"	3-1/32"	.005
LLM2	2 mm	13/32"	3-7/32"	.005
LLM25	2.5 mm	11/16"	3-15/32"	.01
LLM3	3 mm	3/4"	3-7/8"	.02
LLM4	4 mm	15/16"	4-3/32"	.03
LLM5	5 mm	1-1/16"	4-9/16"	.05
LLM6	6 mm	1-7/32"	5-7/16"	.08
LLM8	8 mm	1-3/8"	6-3/16"	.15
LLM10	10 mm	1-17/32"	6-9/16"	.25



▲WARNING: Do NOT use a pipe or similar extension to increase leverage on L-Style Hex-Keys.



▲WARNING: Always wear approved eye protection.

▲WARNING: NOT insulated. Will NOT protect against electrical shock.

Levels & Measuring Tools

Quick, easy and accurate measurements can mean the difference between a job well done and one that misses the mark. Klein offers a variety of levels and other measuring devices that will help you measure up to the task.

For Professionals... Since 1857®



Levels

Features:

Large, high visibility vials are easy to read.

Handy V-grooved edge for pipe and conduit work.

Extruded, die-cast aluminum frame features a convenient built-in hang hole.

Precision edges for accuracy.

Laser-etched rule and markings for high visibility readings.

Powerful rare earth magnets firmly hold the level to ferrous metals.



Magnetic Torpedo Level



930-9

Additional Features:

- Lightweight, precision-made for durability and performance.
- Convenient 9" length for use in tight spaces.
- Three acrylic vials – plumb, level and 45° provide the necessary jobsite measurements.
- Magnetized strip on bottom.

Cat. No.	Overall Length	Weight
930-9	9" (229 mm)	.25 lbs. (0.12 kg)

Rare Earth Magnetic Torpedo Level



931-9RE

Additional Features:

- Powerful rare earth magnets, 10x stronger than strip magnets, hold firmly to iron and steel surfaces.
- Three acrylic vials – plumb, level and 45° provide the necessary jobsite measurements.
- Top read level window simplifies viewing in tight areas.

Cat. No.	Overall Length	Weight
931-9RE	9" (229 mm)	.42 lbs. (0.19 kg)

6" Electrician's Level



931-6RE

Additional Features:

- Unique 3-point design holds securely to conduit.
- For use in measuring bends in conduit.
- Machined billet aluminum design.

Cat. No.	Overall Length	Weight
931-6RE	6" (152 mm)	.325 lbs. (0.15 kg)

▲WARNING: 931-6RE and 9317RE brass bolt contains lead, a chemical known to the State of California to cause cancer, and birth defects or other reproductive harm. Wash hands after handling.

9" Torpedo Level



932-9RE

Additional Features:

- Easy to read vials set for measurements at 0, 30, 45 and 90 degrees.
- Machined billet aluminum design.

Cat. No.	Overall Length	Weight
932-9RE	9" (229 mm)	.46 lbs. (0.21 kg)

All dimensions are in inches and (millimeters) unless otherwise specified.

▲WARNING: Always wear approved eye protection.



Levels

Accu-Bend™ Level



9317RE

Additional Features:

- Ensures precise 90° bends.
- Eliminates dog legs in conduit bends.
- 3 points of contact for superior hold to conduit.
- Relaxed V-Groove accepts up to 1" conduit.
- Solid aluminium frame for extreme durability.



Cat. No.	Overall Length	Weight
9317RE	2-1/2" (64 mm)	.162 lbs (0.07 kg)

⚠WARNING: 931-6RE and 9317RE brass bolt contains lead, a chemical known to the State of California to cause cancer, and birth defects or other reproductive harm. Wash hands after handling.

9" Torpedo Lighted Level



9330RE

Additional Features:

- Lights up for maximum visibility.
- 3-minute auto shut-off saves battery life.
- Includes 2 AAA batteries.
- Water and impact resistant.
- Easy to read vials set for measurements at 0, 45 and 90 degrees.
- Machined billet aluminum design.

Cat. No.	Overall Length	Weight
9330RE	9" (229 mm)	.525 lbs. (0.24 kg)



All dimensions are in inches and (millimeters) unless otherwise specified.

⚠WARNING: Always wear approved eye protection.



Tape Measures

Features:

Clean corner access for flush edge measurements.

Steel belt clip for convenience.

Non-marring foot slides for a clean work surface.



Non-slip rubber case for comfort.

Non-flip case with nylon coated blades that resist abrasion and wear.

True zero feature for accurate inside and outside measuring.

Large rare earth magnetic end hooks for 5x the strength.

Tape Measures – Magnetic



93225



Rare earth magnets are 5x stronger!
Screws securely hold magnets in place.

Additional Features:

- First 11" (279 mm) has oversized, bold numbers (except 93275).
- Easy read fractional scale (except 93275).
- Double-sided rule for measurement while using against wall, ceiling or conduit.
- Horizontal and vertical standout for easy one person measurements.
- Shock and impact resistant case.

Cat. No.	Blade Length	Hook	Weight
93116	16' (5 m)	single	.63 lbs. (0.29 kg)
93125	25' (7.5 m)	single	.91 lbs. (0.41 kg)
93225	25' (7.5 m)	double	.94 lbs. (0.43 kg)
93275*	7.5 m (25')	double	.94 lbs. (0.43 kg)
93430	30' (9 m)	double	1.2 lbs. (0.54 kg)

*Note: 93275 features both centimeters and inches on both sides of blade.

Tape Measure – 25 Feet



93025

Additional Features:

- Oversized, bold blade numbers on first 11" (279 mm) for easy reading.
- 16" stud markings and 19.2" truss markings.
- Non-magnetic single hook.
- Rubberized lock button for comfort.
- Impact absorbing case.

Cat. No.	Blade Length	Hook	Weight
93025	25' (7.5 m)	single	.84 lbs. (0.38 kg)

All dimensions are in inches and (millimeters) unless otherwise specified.

▲WARNING: Always wear approved eye protection.

▲WARNING: Protect hands when cleaning magnetic tip. Use gloves or cloth.

▲WARNING: Avoid magnetic contact with sensitive electronic or computer equipment.

▲WARNING: To avoid personal injury and damage to this tool, do not allow the tape blade to retract into case at full speed.

▲WARNING: NOT insulated. Do NOT use on live circuits.

▲WARNING: Do NOT open case. Spring motor is under tension, and opening case may cause injury.



Tape Measures

Tape Measures – Steel with High-Visibility Case

- High-visibility, high-impact orange case makes it easy to find in a tool box, pouch and on the jobsite.
- 16" stud markings and 19.2" truss markings.
- Made in the USA.



Cat. No.	Blade Length	Width	Weight
928-16HV	16' (4.5 m)	3/4" (19 mm)	.46 lbs. (0.21 kg)
928-25HV	25' (7.5 m)	1" (25 mm)	1.00 lbs. (0.45 kg)

928-25HV

Tape Measure Holders

- Klein offers a complete selection of leather or nylon Tape Holders and Pouches.



5195



5707

Tape Measure	Cat No.	Description
93116, 928-16HV	5194	small leather pouch
	5707	nylon tape measure clip/holder
93025, 93125	5195	medium leather pouch
	5707	nylon tape measure clip/holder
93225, 93275, 928-25HV	5196	large leather pouch
	5707	nylon tape measure clip/holder
93430	5712	nylon pouch

Folding Rules

Wood Folding Rules



901-6

- Strong, 6' (183 cm) long hardwood rules with clear abrasion-resistant coating.
- Black markings on yellow, with red stud center markings every 16 inches.
- Measurements are marked on both sides and both edges, and graduated to 1/16th inch.
- Riveted lock joints are designed for long wear and maintained accuracy.
- Extension slide moves under friction in a T-slot with stops at each end. (Cat. No. 905-6)

Cat. No.	Reading	Length	Weight
900-6	inside	6' (183 cm)	.33 lbs. (0.15 kg)
901-6	outside	6' (183 cm)	.33 lbs. (0.15 kg)
6-Ft. Folding Rule — with Extension			
905-6	outside	6' (183 cm)	.33 lbs. (0.15 kg)

Fiberglass Folding Rules



910-6

- Constructed of tough nylon, reinforced with glass fibers for added durability, and resistance to weather, abrasion and most chemicals.
- Positive locking joints and stainless steel spring hinges for added strength.
- Measurements are marked on both sides and both edges, graduated to 1/16th inch.
- Black markings on yellow, with red stud center markings every 16 inches.
- Engraved graduations on both sides.

Cat. No.	Reading	Length	Weight
910-6	inside	6' (183 cm)	.33 lbs. (0.15 kg)
911-6	outside	6' (183 cm)	.33 lbs. (0.15 kg)

All dimensions are in inches and (millimeters) unless otherwise specified.

▲WARNING: Always wear approved eye protection.

▲WARNING: Do NOT open case. Spring motor is under tension, and opening case may cause injury.

▲WARNING: NEVER use on or near live electrical circuits.

▲CAUTION: To prevent high speed rewinding, apply slight pressure with forefinger on the underside of the blade.



Fiberglass Tapes

Woven Fiberglass Tape – Case

- Woven fiberglass tape with moisture-proof coating of polyvinyl chloride assures durability and protects against oil or chemicals.
- Can be immersed in water without adverse effects.
- All metal parts are nickel-plated for protection against rust.
- End-hooks are permanently attached to reinforced strip.
- Case and reel are ruggedly built yet lightweight and comfortable to use.
- Tape line graduated in feet and inches to 8ths.
- Black graduating numbers and red foot markings on yellow background.
- Protective carrying case encloses tape completely.
- Tape ring tucks neatly into case opening for storage.

Cat. No.	Length	Width	Weight
946-50	50' (15 m)	1/2" (13 mm)	.80 lbs. (0.36 kg)
946-100	100' (30 m)	1/2" (13 mm)	1.20 lbs. (0.54 kg)



946-100

Woven Fiberglass Tape – Open-Reel

- Woven fiberglass tape with moisture-proof coating of polyvinyl chloride assures durability and protects against oil or chemicals.
- Can be immersed in water without adverse effects.
- Black figures on a yellow background are easy to read.
- All metal parts are nickel-plated for protection against rust.
- End-hooks are permanently attached to a reinforced strip.
- Case and reel are ruggedly built, yet lightweight and comfortable to use.
- Tape line is graduated in feet and inches to 8ths.
- Graduations and numbers are black; foot markings are red.
- Contained in an open reel and is easy to handle and rewind.

Cat. No.	Length	Width	Weight
946-150	150' (46 m)	1/2" (13 mm)	1.70 lbs. (0.77 kg)



946-150



Fish Tapes, Accessories & Conduit Tools

Pulling wire and working with conduit is very challenging without the proper tools. Klein Tools complete line of wire pulling tools allow you to get the job done while saving time, effort and materials.

For Professionals... Since 1857®

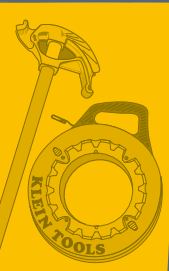

Fish Tapes

Features:

Polypropylene case and handle offer the maximum in impact resistance.

Round inner ring design provides a smooth, surface for winding and rewinding.

Laser etched markings in 1' increments* allow you to more accurately measure the depth of conduit runs and determine the amount of tape left to pay out.



*except nylon & spiral steel



Unique sloped handle optimizes hand position for quick hand-over-hand rewinds.

Raised finger Grips transfer 100% of the winding power from your hand and fingers.

Available in steel, fiberglass and nylon with a wide variety of tips.

Fiberglass Fish Tapes

Additional Features:

- Designed for flexibility and easy navigation through conduit runs.
- Non-conductive, fiberglass fish tape slides easily over existing wires and through multiple bends.
- Durable 7" leader helps push through crowded conduit.
- The lightweight and strong fiberglass composite tape resists harsh elements and is strength rated up to 500 pulling pounds.
- Repair kit (Cat. No. 56115) available to replace tips.
- Replacement metal eyelets (Cat. No. 56116) and spiral steel leaders (Cat. No. 56120) available.

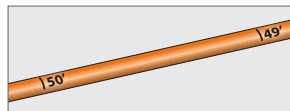

1' permanent laser etched descending increments.



56010

Cat. No.	Tape Size	Reel Diameter	Weight
56009	50' L x 3/16" W (7" leader) (15 m L x 4.8 mm W)	13" (330 mm)	2.8 lbs. (1.27 kg)
56010	100' L x 3/16" W (7" leader) (30 m L x 4.8 mm W)	13" (330 mm)	3.5 lbs. (1.59 kg)
56014	200' L x 3/16" W (7" leader) (60 m L x 4.8 mm W)	17" (432 mm)	6.2 lbs. (2.81 kg)

Replacement Parts

56115	fiberglass fish tape repair kit	2.18 lbs. (0.1 kg)
56116	replacement eyelets	.06 lbs. (0.03 kg)
56120	replacement flexible leaders	.11 lbs. (0.05 kg)



56115

All dimensions are in inches and (millimeters) unless otherwise specified.

▲WARNING: Always wear approved eye protection.

▲WARNING: Never remove screws while fish tape is coiled inside reel.

▲WARNING: NEVER use on or near live electrical circuits.

▲WARNING: Use a safe work position to avoid loss of balance.



Fish Tapes

Non-Conductive Fiberglass Fish Tape

Additional Features:

- Non-conductive fish tape and eyelet tip offer added protection against shock from energized sources.
- Protects existing wires from damage when fishing.
- Eyelet slides easily over existing wires and through multiple bends.
- The lightweight, strong fiberglass tape is strength rated for up to 500 pulling pounds and provides greater pushing power.
- Exclusively designed eyelet incorporates a wire trough that allows you to lay wire in eyelet making head smaller and easier to navigate through packed pipe.
- Repair kit (Cat. No. 56025) available to replace non-conductive tips.
- Replacement metal eyelets (Cat. No. 56116) and spiral steel leaders (Cat. No. 56120) available.

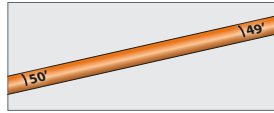

1' permanent laser etched descending increments.



56024

Cat. No.	Tape Size	Reel Diameter	Weight
56024	100' L x 3/16" W (30 m L x 4.8 mm W)	13" (330 mm)	2.8 lbs. (1.27 kg)
Replacement Parts			
56025	non-conductive fiberglass fish tape repair kit		.03 lbs. (0.01 kg)



56025

Nylon Fish Tapes

Additional Features:

- Designed for flexibility and easy navigation through conduit runs.
- Non-conductive fish tape slides easily over existing wires and through multiple bends.
- The lightweight and strong nylon tape resists harsh elements and is strength rated up to 200 pulling pounds.



56012

Cat. No.	Tape Size	Reel Diameter	Weight
56011	50' L x 3/16" W (15 m L x 4.8 mm W)	13" (330 mm)	2.3 lbs. (1.04 kg)
56012	100' L x 3/16" W (30 m L x 4.8 mm W)	13" (330 mm)	3.0 lbs. (1.36 kg)

Spiral Steel Fish Tapes

Additional Features:

- Designed for super flexibility and easy navigation through conduit runs.
- Slides easily over existing wires and through multiple bends.
- The durable spiral steel tape construction yields a maximum pulling force of up to 500 lbs.



56013

Cat. No.	Tape Size	Reel Diameter	Weight
56013	50' L x 3/16" W (15 m L x 4.8 mm W)	13" (330 mm)	5.1 lbs. (2.31 kg)

All dimensions are in inches and (millimeters) unless otherwise specified.

▲WARNING: Always wear approved eye protection.

▲WARNING: NEVER use on or near live electrical circuits.

▲WARNING: Never remove screws while fish tape is coiled inside reel.

▲WARNING: Use a safe work position to avoid loss of balance.



Fish Tapes

1/8" Wide Steel Fish Tapes

Additional Features:

- High strength spring steel fish tapes are stiff for long runs and are great for heavy duty wire pulls.
- Full grip style handle gives you a firm, steady grip as you pull tape from the case.
- Stainless Steel fish tape (Cat. Nos. 56007, 56008) is corrosion resistant and extends the life of the tool.



1' permanent laser etched descending increments.



56001

56002

56003

Cat. No.	Tape Size	Reel Diameter	Weight
Stainless Steel for corrosion resistance			
56007	125' L x 1/8" W x .062" H (38 m L x 3 mm W x 1.5 mm H)	13" (330 mm)	4.7 lbs. (2.13 kg)
56008	240' L x 1/8" W x .062" H (73 m L x 3 mm W x 1.5 mm H)	13" (330 mm)	7.5 lbs. (3.40 kg)
Flat Steel			
56000	25' L x 1/8" W x .045" H (7 m L x 3 mm W x 1.1 mm H)	7" (178 mm)	1.0 lbs. (0.45 kg)
56001	50' L x 1/8" W x .045" H (15 m L x 3 mm W x 1.1 mm H)	7" (178 mm)	1.3 lbs. (0.59 kg)
56002	65' L x 1/8" W x .062" H (19 m L x 3 mm W x 1.5 mm H)	9" (229 mm)	2.6 lbs. (1.18 kg)
56003	125' L x 1/8" W x .062" H (38 m L x 3 mm W x 1.5 mm H)	13" (330 mm)	4.7 lbs. (2.13 kg)
56004	240' L x 1/8" W x .062" H (73 m L x 3 mm W x 1.5 mm H)	13" (330 mm)	7.5 lbs. (3.40 kg)
Replacement Tapes			
56065	65' L x 1/8" W x .062" H (19 m L x 3 mm W x 1.5 mm H)	-	1.7 lbs. (0.77 kg)
56125	125' L x 1/8" W x .062" H (38 m L x 3 mm W x 1.5 mm H)	-	3.3 lbs. (1.50 kg)
56240	240' L x 1/8" W x .062" H (73 m L x 3 mm W x 1.5 mm H)	-	6.1 lbs. (2.77 kg)

1/4" Wide Steel Fish Tapes

Additional Features:

- Tempered, high quality tape keeps its stability as it glides between surfaces for effective pushing and pulling of wire under carpets, through insulated walls and over suspended ceilings.
- 25' length with no snag tip, is perfect for short wire runs associated with light commercial, residential and voice-data-video-audio installations (Cat. No. 56005).



56005 has a no snag plastic tip



1' permanent laser etched descending increments.



56005

Cat. No.	Tape Size	Reel Diameter	Weight
56005	25' L x 1/4" W x .030" H (7 m L x 6.3 mm W x .7 mm H)	7" (178 mm)	1.1 lbs. (0.50 kg)
56006	100' L x 1/4" W x .062" H (30 m L x 6.3 mm W x 1.5 mm H)	13" (330 mm)	6.8 lbs. (3.08 kg)

All dimensions are in inches and (millimeters) unless otherwise specified.

▲WARNING: Always wear approved eye protection.

▲WARNING: Never remove screws while fish tape is coiled inside reel.

▲WARNING: NEVER use on or near live electrical circuits.

▲WARNING: Use a safe work position to avoid loss of balance.

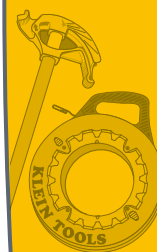

Fish Tape Accessories

Fish Tape Puller

- Exclusive design improves your grip while pulling round-diameter, composite fish tapes.
- Flexible rubberized construction is comfortable in your hand and provides excellent leverage.
- Interlocking teeth molded into channel wrap completely around the tape when squeezed.
- Fits conveniently into center of 13" fish tape case for easy storage.
- Compatible with nylon, fiberglass and spiral steel tapes.



Cat. No.	Length	Weight
56106	7-3/4" (196 mm)	.6 lbs. (0.27 kg)

56106

13" Flexible Leader for Steel Fish Tapes

- For use with 1/8" wide steel fish tapes.
- Heavy duty construction is strength rated up to 500 pulling pounds.
- High capacity eyelet holds up to five #12 unstripped wires and seven #10 bare wires.

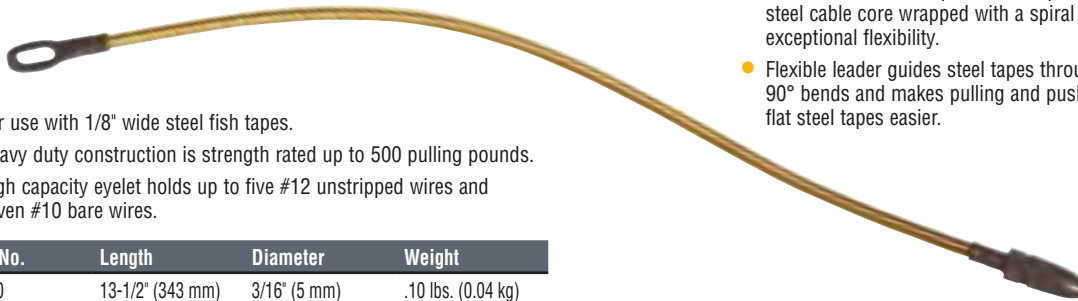

- Retrofit instructions included.
- The 3/16" diameter tape has a rustproof inner steel cable core wrapped with a spiral cover for exceptional flexibility.
- Flexible leader guides steel tapes through 90° bends and makes pulling and pushing flat steel tapes easier.

Cat. No.	Length	Diameter	Weight
50350	13-1/2" (343 mm)	3/16" (5 mm)	.10 lbs. (0.04 kg)

50350

6 Loop Wire Pulling Leader

- Save time by attaching leader to the end of a fish tape and pull up to 6 wires at once.
- Braided steel construction provides up to 450 lbs. pull strength on main eyelet.
- Flexible construction allows for easy navigation through multiple bends in conduit.
- Staggered loop lengths won't overlap and clog pipe.
- For use with 1/8" and 1/4" flat steel fish tapes.



56107

Cat. No.	Length	Weight
56107	11-1/4" (285 mm)	.2 lbs. (0.09 kg)

Steel Fish Tape Puller

- Exclusive design improves your grip while pulling all types of flat steel fish tape.
- Rugged metal construction is comfortable in your hand and provides excellent leverage.
- Internal resistance mechanism securely locks fish tape in place for pulling.
- Compatible with 1/8" & 1/4" tape widths and thicknesses of .045", .062" and .030".
- Compact size – fits easily in your pocket or a tool pouch.



50355

Cat. No.	Length	Weight
50355	3-1/4" (83 mm)	.33 lbs. (0.15 kg)

Steel Fish Tape Swivel Eyelet

- For use with 1/8" wide steel fish tapes.
- Swivel head design helps prevent kinks and allows smoother, easier fishing in tight turns.
- High capacity eyelet holds up to five #12 unstripped wires or seven #10 bare wires.
- High strength steel construction allows for optimal performance over repeated uses.
- Retrofit instructions included.



50351

Cat. No.	Length	Diameter	Weight
50351	1-1/2" (38 mm)	3/16" (5 mm)	.03 lbs. (0.01 kg)

All dimensions are in inches and (millimeters) unless otherwise specified.

▲WARNING: Always wear approved eye protection.

▲WARNING: Never remove screws while fish tape is coiled inside reel.

▲WARNING: NEVER use on or near live electrical circuits.

▲WARNING: Use a safe work position to avoid loss of balance.



Fish Tape Accessories

Fiberglass Fish Tape Repair Kit

- Contains high leverage ratcheting crimper, two replacement eyelets, two 7" replacement leaders, one tube of quick dry glue and comprehensive instructions.
- Multi-function ratcheting crimper (Cat. No. 56115V) cuts tape cleanly, strips tapes and crimps on new attachments.
- Newly crimped on eyelets meet or exceed original factory pulling strength requirements.
- Protective carry case firmly holds all tools and additional parts in handy, organized compartments.



Cat. No.	Set Contains	Weight
56115	high leverage crimper (1 ea.), 7" flexible leader (2 ea.), eyelets (2 ea.), tube quick-drying glue (1 ea)	2.18 lbs. (0.1 kg)

56115

2-Pack 7" Replacement Flexible Leaders & 6-Pack Replacement Eyelets

- For use only with fiberglass fish tapes (Cat. No. 56009, 56010 & 56014).
- Not compatible with nylon fish tapes (Cat. No. 56011 & 56012).
- Attach with Klein Tools ratcheting crimper (Cat. No. 56115V) available in kit 56115 only.



56120

Cat. No.	Length	Weight
56120	8.94" (227 mm)	.11 lbs. (0.05 kg)
56116	1.5" (38 mm)	.06 lbs. (0.03 kg)



56116

Fish Rods & Accessories

Fish and Glow Rods

- Exclusive Splinter Guard™ protection from painful fiberglass splinters
- Variety of flexibilities and lengths for any application such as walls, drop ceilings, attics, crawl spaces, etc.
- LO flex – long, straight feeding; HIGH flex – tight bends in walls; MID flex – all needs in between
- Luminescent glow rods provide added visibility in dark work spaces. Shines 2X brighter and lasts 2X longer than ordinary glow rods.
- Rods have threaded connectors to attach to desired length and prevent snagging on obstructions.
- Sets include bull nose and hook attachments to attach and grab wires



56325



56418

Cat. No.	Description	Set Contains	Overall Length	Diameter	Weight
Fish Rods					
56304	4' Lo-Flex Fish Rod	N/A	4' (1.2 m)	1/4" (6.4 mm)	0.3 lbs. (0.14 kg)
56306	6' Lo-Flex Fish Rod	N/A	6' (1.8 m)	1/4" (6.4 mm)	0.4 lbs. (0.18 kg)
56312	12' Lo-Flex Fish Rod Set	(3) 1/4" diameter 4' fish rods with bullet nose and hook attachments	12' (3.7 m)	1/4" (6.4 mm)	1.05 lbs. (0.48 kg)
56324	24' Lo-Flex Fish Rod Set	(4) 1/4" diameter 6' fish rods with bullet nose and hook attachments	24' (7.3 m)	1/4" (6.4 mm)	1.85 lbs. (0.84 kg)
56325	25' Fish and Glow Rod Set	(5) 1/4" diameter 4' fish rods, (1) 3/16" diameter 5' glow rod with bullet nose and hook attachments	25' (7.6 m)	1/4" and 3/16" (6.4 and 5 mm)	1.8 lbs. (0.82 kg)
Glow Rods					
56405	5' Mid-Flex Glow Rod		5' (1.5 m)	3/16" (5 mm)	0.2 lbs. (0.14 kg)
56406	6' Hi-Flex Glow Rod		6' (1.8 m)	5/32" (3 mm)	0.2 lbs. (0.18 kg)
56409	9' Mid-Flex Glow Rod Set	(6) 3/16" diameter 18" glow rods with bullet nose and hook attachments	9' (2.7 m)	3/16" (5 mm)	0.55 lbs. (0.25 kg)
56415	15' Mid-Flex Glow Rod Set	(3) 3/16" diameter 5' glow rods with bullet nose and hook attachments	15' (4.6 m)	3/16" (5 mm)	0.85 lbs. (0.39 kg)
56418	18' Hi-Flex Glow Rod Set	(3) 5/32" diameter 6' glow rods with bullet nose and hook attachments	18' (5.5 m)	5/32" (3mm)	0.85 lbs. (0.39 kg)



Accessories

Illuminated Fish Rod Tip

- Lights up for maximum visibility in dark spaces.
- Bright white, omni-directional LED light for long life.
- Tapered end for easy pushing and pulling.
- Threaded top for hook or bullet nose attachment (not included).
- Fits drilled holes as small as 5/8".
- Compatible with 1/4", 3/16" and 5/32" diameter rods.
- Replaceable batteries included.



56119

Cat. No.	Description	Dimensions	Weight
56119	illuminated fish rod tip	2.5" L x 37/64" diameter	5.0 oz. (142 g)

Fish Rod Accessories

Cat. No.	Description	Set Contains	Weight
56104	3-piece fish and glow rod attachment set	(1 ea.) whisk attachment (1 ea.) bullet nose attachment (1 ea.) hook attachment	.2 oz. (5.7 g)
50992	hook and bullet nose replacements	n/a	.32 oz. (9.1 g)

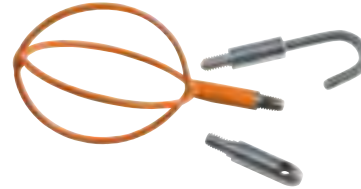

56104

- Attachments help guide, grab, attach and steer wire or cable.
- Compatible with 1/4", 3/16", and 5/32" rod sizes.

Extension Pole – WireSpanner™



56105

- Push/Pull wires over long spans of suspended ceilings, sub-floors, crawl spaces and attics.
- The durable 54" pole quickly and easily telescopes to a maximum of 22' long.
- Each section locks securely into place and will not spin loose or collapse.
- High quality, rigid fiberglass is sturdy, lightweight and slides easily over obstructions.
- Large capacity hook-skid tip pulls multiple wires easily and has a separate eyelet for wire tie-on.

Cat. No.	Description	Collapsed Length	Extended Length	Max. Diameter	Weight
56105	WireSpanner™ installation tool	54" (1.3 m)	22' (6.7 m)	2" (50 mm)	4 lbs. (1.8 kg)
56118	WireSpanner™ carry case	-	-	-	0.4 lbs. (0.2 kg)

All dimensions are in inches and (millimeters) unless otherwise specified.

▲WARNING: Always wear approved eye protection.

▲WARNING: NEVER use on or near live electrical circuits.

▲WARNING: Never remove screws while fish tape is coiled inside reel.

▲WARNING: Use a safe work position to avoid loss of balance.

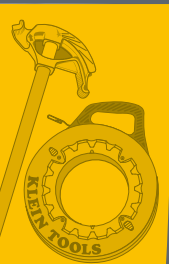

Wire Pulling Lubricant

One-Quart Premium Synthetic Clear Lubricant

- Designed for use primarily in finished workspaces (i.e. around painted walls and carpeted floors).
- The crystal clear formulation is easy to clean-up and will not stain.
- Excellent all purpose lubricant for electrical or datacom applications.
- Compatible with most types of cable jackets.
- Temperature stable - will not separate out in hot environments for when exposed to freezing.

Cat. No.	Container	Temperature Use Range	Weight
51028	one-quart squeeze bottle	20° F to 120° F (-5° C to 50° C)	2.3 lbs. (1.04 kg)



51028

Premium Synthetic Wax®

- High performance lubricant for general electrical and utility applications.
- Temperature stable and does not liquify and drop off after high temperature exposure.
- Compatible with most types of cable, including low density polyethylene.
- Superior “clingability” coats wires and conduit evenly.
- Exceptional lubricity.
- Non-staining, slow-drying, easy clean-up formula.

Cat. No.	Container	Temperature Use Range	Weight
51010	one-quart squeeze bottle	20° F to 122° F (-6° C to 50° C)	2.3 lbs. (1.0 kg)
51012	one-gallon pail	20° F to 122° F (-6° C to 50° C)	8.8 lbs. (3.9 kg)
51013	five-gallon pail	20° F to 122° F (-6° C to 50° C)	44 lbs. (19.9 kg)
56117	one-quart squeeze bottle - 6 pack	20° F to 122° F (-6° C to 50° C)	13.5 lbs. (6.12 kg)



51010

51012



Premium Synthetic Polymer®

- Excellent all-purpose lubricant for electrical, telecommunications and data applications.
- Easy-to-apply gel clings instantly to the cable for easy handling and application.
- Compatible with most types of cable, including polyethylene and semi conducting jackets.
- Superior “clingability” coats wires and conduit evenly.
- Non-staining, slow-drying, easy clean-up formula.

Cat. No.	Container	Temperature Use Range	Weight (lbs.)
51015	one-quart squeeze bottle	20° F to 140° F (-6° C to 60° C)	2.3 lbs. (1.1 kg)
51017	one-gallon pail	20° F to 140° F (-6° C to 60° C)	8.8 lbs. (3.9 kg)
51018	five-gallon pail	20° F to 140° F (-6° C to 60° C)	44 lbs. (19.9 kg)



51015

51017



CERTIFIED TO CSA
STANDARD C22.2 NO. 249-96

All dimensions are in inches and (millimeters) unless otherwise specified.

▲WARNING: Do not use wet product on live circuits. Compound is electrically conductive before it dries.



Wire Pulling Supplies

Poly Pull Line

- Use polypropylene line with manual or power fishing systems for light duty cable or rope pulling applications.
- Ready to use storage containers quickly dispense a tangle free line and also protects line from direct sunlight.
- Line is resistant to rot and mildew.
- Up to 210 lbs. average breaking strength.

Cat. No.	Description	Container Type	Weight
56108	500' (152 m) poly pull line with orange tracer	one-quart size w/locking lid	1 lbs. (0.45 kg)
56110	6500' (1981 m) poly pull line with orange tracer	five-gallon bucket	11 lbs. (4.9 kg)



56108

56110

Conduit Tools

Side-Cutting Pliers – Fish Tape Pulling

- Quickly and easily pulls 1/8" or 1/4" flat-steel fish tape without damaging the tape.
- High leverage design. Rivet is closer to the cutting edge for greater cutting and gripping power than other plier designs.
- Streamlined design with sure-gripping, cross-hatched knurled jaws.



J2000-9NECRTP

Cat. No.	Nose Type	Overall Length	Jaw Length	Jaw Width	Jaw Thickness	Knife Length	Handle Finish	Handle Color	Weight
D213-9NETP	New England	9-3/8" (238 mm)	1-19/32" (41 mm)	1-1/14" (32 mm)	5/8" (16 mm)	25/32" (20 mm)	plastic-dipped	dark blue	1.1 lbs. (0.5 kg)
Journeyman Series – Dual-material handles									
J213-9NETP	New England	9-1/2" (241 mm)	1-19/32" (41 mm)	1-1/14" (32 mm)	5/8" (16 mm)	25/32" (20 mm)	Journeyman	dark blue/black	1.1 lbs. (0.5 kg)
2000 Series* – Heavy-duty cutting knives									
D2000-9NETP	New England	9-3/8" (238 mm)	1-19/32" (41 mm)	1-1/14" (32 mm)	5/8" (16 mm)	25/32" (20 mm)	plastic-dipped	royal blue	1.1 lbs. (0.5 kg)
Journeyman 2000 Series* – Dual-material handles									
J2000-9NETP	New England	9-1/2" (241 mm)	1-19/32" (41 mm)	1-1/14" (32 mm)	5/8" (16 mm)	25/32" (20 mm)	Journeyman	light blue/black	1.1 lbs. (0.5 kg)
J2000-9NECRTP	New England	9-1/2" (241 mm)	1-19/32" (41 mm)	1-1/14" (32 mm)	5/8" (16 mm)	25/32" (20 mm)	Journeyman	blue/black	1.1 lbs. (0.5 kg)

*Cuts ACSR, screws, nails, and most hardened wire. Features combination polished and black-oxide finish.

Conduit Pliers — Locknut and Reaming

- Tightens 1/2" (13 mm) and 3/4" (19 mm) EMT or 1/2" (13 mm) rigid locknuts.
- Fits liquid tight fittings and caps.
- Reams and smooths both inside and outside of conduit.
- Knurled jaws at nose tip pull wire or fish tape.
- Machined nose fits snugly into locknut wings.



D333-8

Cat. No.	Overall Length	Jaw Length	Jaw Width	Jaw Thickness	Point Thickness	Handle Finish	Handle Color	Weight
D333-8	7-3/4" (197 mm)	1-5/8" (41 mm)	15/16" (24 mm)	1/2" (13 mm)	3/16" (4.8 mm)	plastic-dipped	yellow	.55 lbs. (0.25 kg)

Conduit-Fitting and Reaming Screwdriver

- Hooded-blade design keeps tip from slipping out of screws, especially when tightening hard-to-reach conduit fittings. Thicker hood is designed for rugged use.
- Reams and smooths 1/2" (13 mm), 3/4" (19 mm), and 1" (25 mm) thin-wall conduit ends to protect wire and permit correct installation of fittings.



85191

Cat. No.	Shank Tip Width	Shank Length	Overall Length	Weight
85191	3/8" (10 mm)	2-1/2" (64 mm)	7-1/2" (191 mm)	.55 lbs. (0.25 kg)
19353	conduit reamer replacement blade kit			.01 lbs. (0.004 kg)

- Reams both the inside and outside of the conduit at the same time.
- Longer Cushion-Grip handle provides comfort and more torque for reaming.

All dimensions are in inches and (millimeters) unless otherwise specified.

⚠WARNING: Always wear approved eye protection.

⚠WARNING: NOT insulated. Plastic-dipped or slip-on plastic handles are NOT intended for protection against electrical shock.

Conduit Benders

Features:

Exclusive design reduces rippling and ovaling of conduit.

Wide foot pedal provides excellent stability, leverage and comfort.

Interior clamp securely holds conduit while cutting with hacksaw.

Bold cast-in symbols, degree scales, multiplier scales and center of bend marks help save time on the job.

The traditional **Benfield® head design** accurately and consistently performs common bends such as Stub Ups, Offsets, Back-to-Back and Saddle Bends.

Interior hook surface prevents conduit from rolling or twisting during bends.

Easily visible arrow for ease of alignment on conduit marks.



Aluminum Conduit Benders

Additional Features:

- Lightweight die-cast aluminum construction.

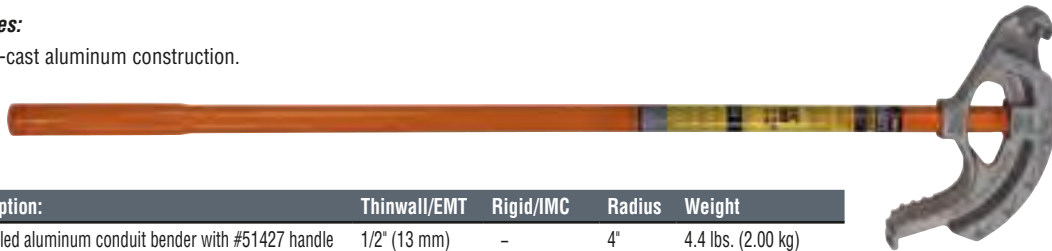

Cat. No.	Description:	Thinwall/EMT	Rigid/IMC	Radius	Weight
56206	assembled aluminum conduit bender with #51427 handle	1/2" (13 mm)	-	4"	4.4 lbs. (2.00 kg)
56207	assembled aluminum conduit bender with #51427 handle	3/4" (19 mm)	1/2" (13 mm)	5"	5.4 lbs. (2.45 kg)

56207

Iron Conduit Benders

Additional Features:

- High strength steel handle features a swaged end for inserting conduit to correct overbends (Cat. Nos. 56203 & 56204 only).
- Bright orange color handle is easy to spot on the jobsite.



56205

Cat. No.	Description:	Thinwall/EMT	Rigid/IMC	Weight
56208	conduit bender head	1/2" (13 mm)	-	2.1 lbs. (0.95 kg)
56209	conduit bender head	3/4" (19 mm)	1/2" (13 mm)	3.2 lbs. (1.45 kg)
56210	conduit bender head	1" (25 mm)	3/4" (19 mm)	5.5 lbs. (2.49 kg)
56211	conduit bender head	1- 1/4" (32 mm)	1" (25 mm)	16.9 lbs. (7.67 kg)
56203	assembled conduit bender w/#51427 handle	1/2" (13 mm)	-	5.5 lbs. (2.49 kg)
56204	assembled conduit bender w/#51427 handle	3/4" (19 mm)	1/2" (13 mm)	6.6 lbs. (2.99 kg)
56205	assembled conduit bender w/#51428 handle	1" (25 mm)	3/4" (19 mm)	11.6 lbs. (5.26 kg)



56211

All dimensions are in inches and (millimeters) unless otherwise specified.

⚠WARNING: Always wear approved eye protection.

⚠WARNING: Use a safe work position to avoid loss of balance.

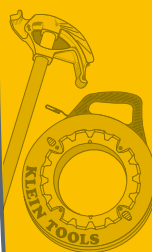

Conduit Bender Handles

Bender Handles



51427

- Available in multiple sizes and lengths and are compatible with all Klein Tools conduit bender heads.
- High-strength steel eliminates flex and provides excellent feel, control and leverage.
- Handle features an enlarged diameter hollow end for inserting conduit to correct overbends (Cat. No. 51427).
- Bright orange color is easy to spot on the jobsite.

Cat. No.	Description:	Weight
51427	conduit bender handle - 38" L, 3/4" NPT tap size fits 1/2" and 3/4" bender heads and is replacement handle for #56208 and #56209.	3.5 lbs. (1.6 kg)
51428	conduit bender handle - 44" L, 1" NPT tap size fits 1" bender head for #56210.	6.0 lbs. (2.7 kg)
51429	conduit bender handle - 54" L, 1-1/4" NPT tap size fits 1-1/4" bender head for #56211.	8.9 lbs. (4.0 kg)

Armored Cable Cutter

BX and Armored Cable Cutter

- Cuts BX and 3/8" armored cable.
- Eliminates burrs.
- Does not nick cable.
- Easily cuts 3/8" flexible conduit and #10, 12, and 14 armored cables with up to 4 wires with a couple of turns of the handle.
- Depth of cut adjusts between standard MC and reduced diameter MC.
- Extra blade storage in handle.
- Use with Klein Tools replacement blade Cat. No. 53726 or 53726-SEN.

Cat. No.	Length	Weight
53725	7-1/4" (184 mm)	2.0 lbs. (0.9 kg)
Replacement Parts		
53726	Replacement blade for use with Klein Tools cable cutter Cat. No. 53725 or Cat. No. 53726-SEN.	0.1 lbs. (0.04 kg)



53725



53726

Conduit Scoring Tool

Electrician's Conduit Scoring Tool

- Durable zinc cast scoring tool eliminates spiraling
- Used for scoring 1/2", 3/4" and 1" EMT conduit.
- Klein-designed, patented scoring wheel scores and allows clean conduit snaps without leaving burrs inside.
- 1" scoring wheel conveniently located in base of the handle; no tools required to replace scoring wheels.
- Four roller tracks specifically designed for professional use.
- Compact, enclosed design for use on job sites.

Cat. No.	Length	Conduit Diameter	Weight
88906	6.02" (153mm)	scores 1/2", 3/4" and 1" EMT conduit	1.25 lbs. (0.6 kg)
Replacement Parts			
88907	1/2" and 3/4" EMT replacement scoring wheel		
88908	1" EMT replacement scoring wheel		



88906



88907



88908

All dimensions are in inches and (millimeters) unless otherwise specified.

⚠WARNING: Always wear approved eye protection.

⚠WARNING: NEVER use on or near live electrical circuits.

PVC-Cutters

PVC-Cutter

- Cuts up to 3/4" schedule 40 PVC.
- Makes clean burr-free cuts in PVC and flexible pipe.
- Reversible blade doubles life.
- Cuts 1-3/8" outer diameter flexible plastic pipe.
- Steel construction for strength.
- Guide helps cut pipe squarely.
- Handle latch keeps tool closed.

Cat. No.	PVC Cutting Capacity	Non-metallic Tubing Cutting Capacity	Length	Weight
50506	3/4" (19 mm) schedule 40	1" (19 mm)	8-1/2" (215 mm)	1.0 lbs.(0.45 kg)

Replacement Parts				
50549	replacement blade		3-1/4" (83 mm)	.08 lbs. (0.03 kg)



50506



50549

Ratcheting PVC-Cutter

- Makes clean, burr-free cuts through PVC.
- High-leverage ratchet-action for maximum cutting power.
- Easy one-hand cutting.
- Special heat-treated blades stay sharp longer and reduce pipe deformation.
- Hooked jaw holds pipe in proper cutting position.

Cat. No.	PVC Cutting Capacity	Non-metallic Tubing Cutting Capacity	Length	Weight
50500	1/2" - 1-1/4"	1" (19 mm)	9" (229 mm)	1.1 lbs. (0.5 kg)

Replacement Parts				
50503	replacement blade		4" (102 mm)	.19 lbs. (0.08 kg)
50511	replacement spring		2-3/8" (60 mm)	.006 lbs. (0.002 kg)



50500



50503

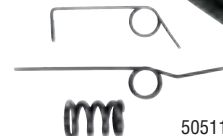

50511

Large Capacity Ratcheting PVC-Cutter

- Makes clean, burr-free cuts through PVC.
- High-leverage ratchet-action for maximum cutting power.
- Special heat-treated blades stay sharp longer and reduce pipe deformation.
- Handle latch keeps tool closed.

Cat. No.	PVC Cutting Capacity	Non-metallic Tubing Cutting Capacity	Length	Weight
50501	1/2" - 2"	1" (19 mm)	16-1/2" (419 mm)	2.6 lbs. (1.2 kg)

Replacement Parts				
50504	replacement blade		5-3/4" (146 mm)	.53 lbs. (0.24 kg)
50512	replacement spring		2-3/8" (60 mm)	.01 lbs. (0.004 kg)



50501



50512

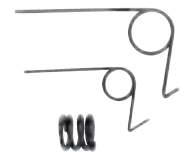

50504

All dimensions are in inches and (millimeters) unless otherwise specified.

▲WARNING: Always wear approved eye protection.

▲WARNING: NEVER use on or near live electrical circuits.

▲WARNING: Do NOT use to cut metallic pipes or cable wire.

▲WARNING: Do NOT cut cold PVC.



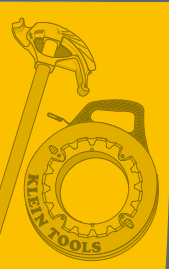

Pain-Free Wire Pulling

SPLINTER GUARD™
PROTECTIVE COATING

Fish & Glow Rods

New Splinter Guard™ fiberglass fish and glow rods from Klein Tools® now include a proprietary protective coating to safeguard your hands from splinters when wire pulling.

KLEIN TOOLS 
For Professionals... Since 1857™

Personal Protective Equipment & Safety Products

Klein Tools provides personal protective equipment and safety products to help guard against a wide variety of occupational hazards.

F O R P R O F E S S I O N A L S . . . S I N C E 1 8 5 7 ®



Personal Protective Equipment & Safety Products



Protective Eyewear

Features:

Impact resistant polycarbonate lenses block greater than 99.9% of harmful UVA and UVB radiation up to 400 nanometers.

Permanently bonded **Uvextreme® anti-fog coating** with anti-scratch, anti-static and UV protection properties.

Adjustable spatulite temples provide a comfortable customized fit.

Temple-end holes for easy lanyard attachment.

Wrap-around lens with integrated side shields provides a clear, unobstructed field of vision and superior coverage.

Meets the traffic signal color recognition requirements of **ANSI Z80.3-1996**.



Lens Color



Uvextreme® and Spectrum Control Technology® (SCT®) are registered trademarks of Sperian Eye & Face Protection, Inc.

**SCT® = Spectrum Control Technology*



Protective Eyewear – Standard

Additional Features:

- Meets Mil V₀ ballistic test for impact.
- Soft elastomer brow-guard absorbs, diffuses and deflects impact energy.
- Soft flexible fingers adjust and conform to most nasal profiles reducing slippage.
- Three position ratchet lens inclination adjusts for a custom fit and unsurpassed comfort.
- Lens designed to follow the contour of the cheekbone and create a “zone of protection.”
- Dual 9-base wrap-around lens provides uncompromised peripheral vision.
- Unique ventilation channel delivers an outstanding level of moisture and fog control.



60053

Cat. No.	Frame Color	Lens Color	Environment	Light Intensity	True Color Recognition	Visual Light Transmitted	IR Absorption	Blue Light transmittance	Accidental Arc Protection	Weight (oz.)
60046	black	dark gray	outdoor	normal to bright	Yes	10%	60%	-	No	2.4
60047	black	SCT* gray	outdoor	normal to bright	Yes	15%	>85%	<7%	Yes	2.4
60049	black	amber	indoor/ outdoor	normal to low	No	90%	-	-	No	2.4
60053	black	clear	indoor	normal to low	Yes	92%	-	-	No	2.4
60054	royal blue	clear	indoor	normal to low	Yes	92%	-	-	No	2.4
60055	black	espresso	outdoor	normal to bright	Yes	15%	60%	<3%	No	2.4

Protective Eyewear – Frameless

Additional Features:

- Meets military V0 ballistic test for impact (7x greater than ANSI).
- Secure wrap-around brow expands to fit a wide range of users.
- Ultra lightweight design offers ultimate comfort at less than one ounce.
- Proprietary Floating Lens offers increased flexibility in fit.
- Soft temple tip pads provide a comfortable and secure fit.
- Does not have lanyard holes.



60056

Cat. No.	Frame Color	Lens Color	Environment	Light Intensity	True Color Recognition	Visual Light Transmitted	IR Absorption	Blue Light transmittance	Accidental Arc Protection	Weight (oz.)
60056	black	clear	indoor	normal to low	Yes	92%	-	-	No	.15
60057	black	espresso	outdoor	normal to bright	Yes	15%	60%	<3%	No	.15

▲WARNING: It is important that users of these products read, understand, and follow all instructions, cautions, and warnings that are attached to and/or packed with the product.



Personal Protective Equipment

Full Face Shield

- Free-floating ratchet head gear with full-tension adjustment and sweat band for added comfort.
- High-impact, full-front cap and chin guard for extra protection.
- Anti-warp design resists dimensional distortion from heat and moisture.
- Big window extends past ears, providing wide-angle protection.
- Window is made of clear, tough acetate.
- Meets ANSI Z87.1-2003 and CSA Z94.3.

Cat. No.	Description	Weight (lbs.)
60060	window dimensions: 19-1/2" W x 6-1/2" H (495 mm x 165 mm)	1.45

All dimensions are in inches and (millimeters).



60060

Disposable Dust Masks

- Comfortable, full-size mask keeps dust out, lets air in freely for dependable protection and easy breathing.
- For use around grinding and sanding operations, drilling in plaster or cement, cleaning dusty areas, and similar applications.
- Double-absorbent filter material is non-allergenic.
- Elastic band and soft, flared edges make for a comfortable fit.
- Metal nosepiece conforms to fit snugly around facial contours.
- Mask stands out away from nose and mouth, and won't collapse when wet from use or humidity.

Cat. No.	Description	Weight (lbs.)
60080	box of 50 disposable dust masks	.01

⚠WARNING: These masks are NOT SUITABLE for use against toxic or hazardous air contaminants. If there is any doubt, consult an industrial hygienist.



60080

Hard Caps and Accessories

- High-density polyethylene hard caps meet ANSI Z89.1-2003 specifications for Class E.
- Unique nape strap holds hat firmly in place.
- Washable, shrink-and stretch-proof straps and bands.
- Porous brow pad promotes ventilation for comfort.
- Standard size fits head sizes 6 - 8.
- Full 6-point ratcheting suspension.
- Headband clips help hold goggles in place over eyes or on front of cap.
- Rain trough helps keep neck dry.
- Slots at sides for attaching Cat. No. 60060 face shield and other protective gear. Requires 61970 universal slot adapter.

Cat. No.	Description	Color	Weight (lbs.)
60009	Hard cap	white	.85
60010	Hard cap	yellow	.85
60011	Hard cap	blue	.85



Available in three colors



60010

Cat. No.	Description	Weight (lbs.)
Hoodliner		
60015	winter hard-cap liner, one size fits all	.15
Face Shield		
60060	full face shield	1.45

⚠WARNING: It is important that users of these products read, understand, and follow all instructions, cautions, and warnings that are attached to and/or packed with the product.



Hard Hats & Caps

V-Gard® Cap and Hat

- Polyethylene shell with 4-point Fas-Trac® ratcheting suspension.
- Standard size fits head sizes 6 - 8.
- Cap and Full-Brim Hat style available.
- Three branding choices: plain front, Klein Tools Lineman Logo, Klein Tools Standard Logo.
- Three color choices: White and Blue.
- Type I helmet meets or exceeds ANSI Z89.1-2003 and CSA Z94.1-2005 specifications for Class E.
- Third Party Certified by Safety Equipment Institute.
- Full line of accessories designed specifically for the V-Gard® Cap and Hat are available.





60031

Available in two colors



V-Gard® and Fas-Trac® are registered trademarks of MSA, the safety company.

Front Logo	none						KLEIN TOOLS®		
Style	Cat. No.	Color	Weight (lbs.)	Cat. No.	Color	Weight (lbs.)	Cat. No.	Color	Weight (lbs.)
	60018	blue	.86	60019	white	.86	60022	white	.86
				60021	blue	.86			
	60028	white	.95	60031	white	.95	60034	white	.95
				60030	blue	.95			
All V-Gard helmet backs contain the Klein logo with American flag (pictured blue hard hat in square). Logo color varies depending on shell color.									

Advance® Cap

- Vented style provides cooling vents for improved air circulation and comfort.
- Glaregard™ under the brim reduces reflective glare.
- Lateral contours above the ear for easy integration of hearing protection.
- Polyethylene shell with 4-point Fas-Trac® ratcheting suspension.
- Lightweight design for added comfort.
- Standard size fits head sizes 6 - 8.
- Branding: Plain front with Klein Tools Logo and American Flag on the back of the cap.
- Type I helmet meets or exceeds ANSI Z89.1-2003 and specifications for Class C.
- Third Party Certified by Safety Equipment Institute.
- Full line of accessories designed specifically for the Advance® Cap.



60027



Available in two colors



Cat. No.	Color	Weight (lbs.)
60025	white	.84
60027	blue	.84

Scope of Z89.1 - 2003 American National Standard for Head Protection

The most recent standard was approved in July 2003 and continues to cover requirements for two types of impact-resistant helmets:

TYPE I (Top Impact) Helmets intended to reduce the force of an impact to the top of a wearer's head.

TYPE II (Top and Lateral Impact) Helmets intended to reduce the force of an impact resulting from a blow received off-center or to the top of a wearer's head. The new standard's performance requirements for Type I and Type II Helmets are equivalent to those specified in the 1998 revision.

Electrical Performance

CLASS E (Electrical) Helmets intended to reduce the danger of exposure to high-voltage electrical conductors, proof-tested at 20,000 volts.

CLASS G (General) Helmets intended to reduce the danger of exposure to low-voltage electrical conductors, proof-tested at 2,200 volts.

CLASS C (Conductive) Helmets not intended to provide protection from electrical conductors. The electrical performance requirements in the 2003 standard are identical to those in the 1997 standard.

▲WARNING: It is important that users of these products read, understand, and follow all instructions, cautions, and warnings that are attached to and/or packed with the product.



Accessories

V-Gard®, Advance® and Skullgard® Accessories

Cat. No.	Description	Weight (oz.)
Defender® + Faceshield Frames (All frames meet Z87.1-2003)		
59985	Plus Universal Foldback Frame-dielectric for caps	2.9
Visors (All visors meet Z87.1-2003, Arc Shields meet NFPA 70E, Class 2)		
59990	Arc Shield Visor - tinted (light green) HIGH-IMPACT 10" x 20" x 0.60" propionate complete w/ chin guard, 14 Cal - Z87 Basic Impact	9.5

Advance®, Defender®, Fas-Trac®, Skullgard®, and V-Gard® are registered trademarks of MSA. Accessories sold separately.



59990

Klein Kleeners® Hand Cleaning Towels

- Simple and convenient.
- Pre-moistened towels.
- No rinsing – no drying – no residue.
- Powerful, yet gentle, pumice-like cleaning action.
- Quickly loosens, dissolves, and absorbs dirt and grease.
- Features a natural citrus solvent that's gentler than petroleum-based hand cleaners.

Cat. No.	Container Size	Towel Size	Weight (lbs.)
51425	72-count bucket	9" x 12" (229 mm x 305 mm)	2.45



51425

Personal Protective Equipment
& Safety Products



▲WARNING: It is important that users of these products read, understand, and follow all instructions, cautions, and warnings that are attached to and/or packed with the product.

Journeyman™ Gloves

NEW!

JOURNEYMAN™

Utility Gloves

- Moisture wicking and breathable Trek Dry™ stretch material on top with sponge foam and tricot lining for maximum comfort.
- Durable synthetic leather palm.
- Reinforced thumb and finger panels add protection and durability.
- Wide opening elastic cuff for easy entry.

	Medium	Large	Extra-Large	Weight
Cat. No.	40205	40206	40207	.13 (lbs.) .06 (kg)

Trek Dry™ is a trademark of Mechanix Wear, Inc.



40206

Camouflage Gloves

- Mossy Oak® Break-Up Infinity™ pattern.
- Moisture wicking and breathable Trek Dry™ stretch material on top with sponge foam and tricot lining for maximum comfort.
- Reinforced thumb and finger panels add protection and durability.
- Single layer, seamless palm made of durable synthetic leather for improved fit and dexterity.
- Soft molded rubber closure with hook and loop secures fit.

	Medium	Large	Extra-Large	Weight
Cat. No.	40208	40209	40210	.17 (lbs.) .08 (kg)

Trek Dry™ is a trademark of Mechanix Wear, Inc.
Mossy Oak® is registered trademark of Haas Outdoors Inc.



40209

"Cold Weather Pro" Gloves

- Palm and fingers lined with Thinsulate™ C40 with fingertip designed for improved dexterity.
- Water resistant nylon back lined with Thinsulate™ C100.
- Durable rubberized palm provides water resistance and grip with 2mm EVA foam padding for impact protection.
- 5 mm EVA foam knuckle for impact protection and comfort.
- Neoprene thumb and cuff for comfort and water resistance.
- Molded rubber closure with hook and loop secures fit.

	Medium	Large	Extra-Large	Weight
Cat. No.	40211	40212	40213	.29 (lbs.) .13 (kg)

Thinsulate™ is trademark of 3M.



40212

▲WARNING: Not flameproof or fire retardant. DO NOT expose to open flame or sparks.



"Grip" Gloves

- Armortex® rubberized grip on the fingers with reinforced synthetic leather palms and thumb for ample grip in both wet and dry conditions.
- PORON® padding material in the palm to absorb impact and vibration.
- Moisture wicking and breathable Trek Dry™ stretch material on top with sponge foam and tricot lining for maximum comfort.
- Machine washable.
- Flexible yet impact absorbing thermo plastic rubber (TPR) protects the fingers and back of the hand.
- Neoprene cuff and soft molded rubber closure with hook and loop secures fit.

	Medium	Large	Extra-Large	Weight
Cat. No.	40214	40215	40216	.29 (lbs.) .13 (kg)

Trek Dry™ is a trademark of Mechanix Wear, Inc.
 PORON® is a registered trademark of Rogers Corp.



40215

"Extreme" Gloves

- Flexible yet impact absorbing thermo plastic rubber (TPR) and EVA foam protects the fingers, knuckles and back of the hand.
- PORON® padding material in the palm to absorb impact and vibration.
- Palm and thumb reinforced with synthetic leather for extra durability.
- Breathable two-way stretch materials on top with sponge foam and tricot lining for maximum comfort.
- Rubberized fingertips for extra grip.
- Wrist closure with hook and loop secures fit.

	Medium	Large	Extra-Large	Weight
Cat. No.	40217	40218	40219	.34 (lbs.) .15 (kg)

PORON® is a registered trademark of Rogers Corp.



40218

Leather Gloves

- Genuine professional grade leather offers the finest in protection and comfort.
- Flexible yet impact absorbing thermo plastic rubber (TPR) protects the fingers and back of the hand.
- Reinforced palm with 2mm EVA foam padding for impact protection.
- Moisture wicking and breathable Trek Dry™ stretch material on top with sponge foam and tricot lining for maximum comfort.
- Machine wash and dry.
- Neoprene cuff and soft molded rubber closure with hook and loop secures fit.

	Medium	Large	Extra-Large	Weight
Cat. No.	40220	40221	40222	.30 (lbs.) .14 (kg)

Trek Dry™ is a trademark of Mechanix Wear, Inc.



40221



⚠WARNING: Not flameproof or fire retardant. DO NOT expose to open flame or sparks.

Pro Utility Gloves

- Reinforced area at base of thumb strengthens key wear area.
- Wrap around design at index finger for increase wear.
- Elastic position below heel of the hand for a snug, comfortable fit.
- Extended cuff for easier on/off.
- Sewn in hang-up loop for storage.
- Nylon synthetic suede palm is durable and washable.

	Medium	Large	Extra-Large	Weight (lbs.)
Cat. No.	40030	40031	40032	.25



40030

Pro Framer Work Gloves

- Fingerless design on thumb, index and middle finger provides increased sensitivity for handling wire connectors, screws, nails and small parts.
- Protective Thermal Plastic Rubber (TPR) finger patches.
- Elastic position below heel of the hand for a snug, comfortable fit.
- Extended cuff for easier on/off.
- Palm features slip-resistant construction for better gripping power.

	Medium	Large	Extra-Large	Weight (lbs.)
Cat. No.	40034	40035	40036	.28



40034

Pro Heavy-Duty Protection Gloves

- Fingers feature slip-resistant material for better grip and wear.
- Protective Thermal Plastic Rubber (TPR) finger patches.
- Double row padded knuckle for added protection.
- Palm features slip-resistant construction for better gripping power.
- Hook and loop cuff for secure fit.
- Extended cuff for easier on/off.
- Spandex material for increased comfort.

	Medium	Large	Extra-Large	Weight (lbs.)
Cat. No.	40038	40039	40040	.46



40038

Pro Leather Work Gloves

- Grain goat skin palm patches for better gripping and durability.
- Double row padded knuckle for added protection.
- Hook and loop cuff for secure fit.
- Spandex material for increased comfort.
- Extended cuff for easier on/off.
- Sewn in hang-up loop for storage.

	Medium	Large	Extra-Large	Weight (lbs.)
Cat. No.	40042	40043	40044	.30



40042

⚠WARNING: Not flameproof or fire retardant. DO NOT expose to open flame or sparks.



Utility Gloves

- Supple, breathable, durable synthetic leather palm added for firm grip.
- Two-way stretch spandex padded top features form-fitting elasticity.
- Reinforced thumb, index finger and fingertips add protection.
- Concealed interior seam stitching prevents snagging.
- Wide opening elastic cuff features an easy entry design.
- Contact points on index finger and thumb feature smooth surface for improved handling of objects.

	Medium	Large	Extra-Large	Weight (lbs.)
Cat. No.	40052	40053	40054	.25



40052

Framer Gloves

- Fingerless design on thumb, index and middle finger provides increased sensitivity for handling wire connectors, screws, nails and small parts.
- DURA-FIT™ synthetic leather palm offers maximum comfort and durability.
- Non-slip rubberized Zeus™ Clarino® finger grippers improve grip and control.
- Lycra® panels between fingers add comfort and ventilation.
- Easy-entry Neoprene cuff ventilates and increases comfort.
- Thermal Plastic Rubber (TPR) cuff strap with hook and loop closure.

	Medium	Large	Extra-Large	Weight (lbs.)
Cat. No.	40057	40058	40059	.28

Zeus™ Clarino® and DURA-FIT™ are trademarks of Kuraray Co., Ltd. Lycra® is registered trademark of INVISTA for premium stretch fiber and fabric.



40057

Heavy-Duty Protection Gloves

- Streamlined high-density accordion knuckle panel reduces impact.
- High profile, impact absorbing molded Thermal Plastic Rubber (TPR) finger protection.
- Non-slip rubberized Zeus™ Clarino® finger and thumb grippers and panel on heel of hand provide grip control and longer wear.
- Synthetic leather with breathable mesh side-insert finger panels for comfort and flexibility.
- Two-ply synthetic leather palm with anatomically die cut Ethylene Vinyl Acetate (EVA) foam padded impact zones.
- Thermal Plastic Rubber (TPR) cuff strap with hook and loop closure.
- Neoprene cuff allows easier access with additional wrist protection and comfort.

	Medium	Large	Extra-Large	Weight (lbs.)
Cat. No.	40062	40063	40064	.46

Zeus™ Clarino® is a trademark of Kuraray Co., Ltd.



40062

Leather Work Gloves

- Genuine Goatskin professional-grade leather offers the finest in comfort and protection.
- Two-way form-fitting spandex top increases ventilation, comfort and fit.
- Molded Thermal Plastic Rubber (TPR) ribs offer flexible protection for back of hand and fingers.
- Lightly padded palm for increased grip and comfort.
- Easy-entry elastic cuff ventilates and increases comfort.
- Stretch knuckle with Ethylene Vinyl Acetate (EVA) foam padding.
- Thermal Plastic Rubber (TPR) cuff strap with hook and loop closure.

	Medium	Large	Extra-Large	Weight (lbs.)
Cat. No.	40067	40068	40069	.30



40067

⚠WARNING: Not flameproof or fire retardant. DO NOT expose to open flame or sparks.

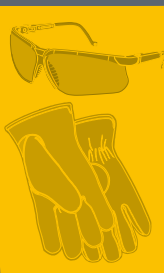

Gloves

Deerskin Work Gloves

- Premium deerskin, soft and form-fitting for maximum comfort.
- Gunn cut with seams away from wear surfaces.
- Inseam index finger.
- Shirred-elastic wrist back.
- Natural light-tan color.

Cat. No.	Size	Weight (lbs.)
40020	small	.20
40021	medium	.22
40022	large	.23
Lined – Pile Lining		
40016	medium	.36
40017	large	.38
40018	extra large	.41



40022

Cowhide Driver's Gloves

- Tough, durable, sueded cowhide leather.
- Easy-action thumb – unique design allows leather to conform to your thumb and hand (Cat. Nos. 40003, 40004, 40006).
- Thermolite® lining for warmth (Cat. Nos. 40014 and 40015).
- Gunn cut with seams away from wear surfaces.
- Lap-seam index finger and shirred-elastic wrist back.
- Gray color.

Cat. No.	Size	Weight (lbs.)
40003	small	.30
40004	medium	.40
40006	large	.43
40014*	large	.47
40015*	extra large	.51



40014

*Thermolite® is a registered trademark for INVISTA certified performance fabrics containing proprietary INVISTA fibers and, in some cases, other companion fibers.

Medium and Long-Cuff Gloves

- Heavy sueded leather (Cat No. 40008)
- Soft, flexible, top-grain cowhide leather (Cat. Nos. 40010 and 40012).
- Leather fingers, palm, pull, and knuckle strap (Cat. Nos. 40010 and 40012).
- Gunn cut with seams away from wear surfaces.
- Wing thumb, seamless index finger, elastic wrist-back strap.
- Lined palm and fingers.
- Rubberized, waterproof, bell gauntlet cuff 5" (127 mm) long (Cat. Nos. 40010 and 40012).



40008



40010

Cat. No.	Size	Weight (lbs.)
40008	large – medium cuff	.48
40010	large	.59
40012	extra-large	.68



Gloves

Lineman Work Gloves

- 4" Neoprene cuff with side vents.
- Soft grain leather construction with reinforced leather patches.
- Double-row padded knuckle for durability.
- Black spandex back with Klein lineman logo patch.

Cat. No.	Size	Weight (lbs.)
40080	medium	.46
40082	large	.51
40084	extra-large	.55
40086	extra-extra-large	.59

▲ **WARNINGS:** These gloves are not intended for energized electrical use.



40080

Electrician's Gloves

- Durable construction allows flexibility.
- Features slip resistant construction.
- Spandex material is breathable and comfortable to wear all day.
- Constructed with a reinforced area at the base of the thumb.
- Elastic cuff for secure and comfortable fit.
- Index fingers are wrapped with slip-resistant material.
- Extended cuff for easy on/off.

Cat. No.	Size	Weight (lbs.)
40072	large	.46
40074	extra-large	.48

▲ **WARNINGS:** These gloves are not intended for energized electrical use.



40072

Heavyweight Jersey Gloves

- Soft, comfortable, general-purpose gloves.
- Made of 100% cotton jersey.
- Cat. No. 40002 has a knit wrist.
- Cat. No. 40001 has a fleece lining and an open cuff.
- Dark-brown color.

Cat. No.	Size	Weight (lbs.)
40002	fits most hand sizes	.15
40001	lined version – fits most hand sizes	.16



40002



Safety Products

Lockouts with Interlocking Tabs

- Specifically designed for locking out power sources such as disconnects, switches, and panel boxes.
- Double interlocking hasp of tempered steel with patented interlocking tabs for extra security.
- Hasps are bright zinc-plated.
- Riveted construction.
- Six-hole locking bodies coated with red vinyl plastic.
- Holes will accept up to 5/16" (8 mm) diameter shackles.



45201

Cat. No.	Closed Hasp I.D.	Weight (lbs.)
45200	1" (25 mm)	.200
45201	1-1/2" (38 mm)	.250

⚠WARNING: Use only in accordance with OSHA requirements.

Barricade and Warning Tapes

- Bold, black lettering on bright, long-lasting color backgrounds.
- Yellow background for CAUTION/CAUTION tape.
- Red background for CAUTION-BURIED ELECTRIC LINE tape.
- Made of tough, durable (2.5 mil) polyethylene.
- Highly resistant to acids, alkalis, and other soil components.
- Tapes are 3" (76 mm) wide, and are available in either 200' or 1000' rolls.



58000

Cat. No.	Description	Width	Length	Weight (lbs.)
58000	CAUTION – CAUTION legend with black letters on bright-yellow background	3" (76 mm)	200' (61 m)	.900
58001	CAUTION – CAUTION legend with black letters on bright-yellow background	3" (76 mm)	1000' (305 m)	3.600
58002	CAUTION – BURIED ELECTRIC LINE legend with black letters on bright-red background	3" (76 mm)	200' (61 m)	.800
58003	CAUTION – BURIED ELECTRIC LINE legend with black letters on bright-red background	3" (76 mm)	1000' (305 m)	3.500



Tool Pouches, Carriers, Belts & Suspenders

Just as Klein offers a variety of tools designed for specific needs, Klein offers a variety of tool pouches, carriers, belts, and suspenders that suit virtually every preference and need.

F O R P R O F E S S I O N A L S . . . S I N C E 1 8 5 7 ®



Tool Pouches, Carriers,
Belts & Suspenders



Tool Pouches

7-Pocket Tool Pouch

- Soft, pliable, white leather.
- Riveted to assure long life.
- Heavy-duty chain tape thong securely fastened with a rivet.

Cat. No.	Pockets (Total Number)	Specialty Add-Ons	Belt Connection	Belt Width	Overall Size	Weight (lbs.)
5166	7	chain tape thong	tunnel	2-1/4" (57 mm)	7" x 9-1/2" (178 mm x 241 mm)	.92



5166

8-Pocket Tool Pouch

- Soft, pliable, white leather.
- Roomy pouch for electricians and maintenance workers.
- Riveted and stitched for extra durability.
- Heavy-duty chain tape thong securely fastened with a rivet.
- Stainless steel clip holder accepts most tape clips up to 1-1/4" wide.

Cat. No.	Pockets (Total Number)	Specialty Add-Ons	Belt Connection	Belt Width	Overall Size	Weight (lbs.)
5178	8	knife snap, chain tape thong, metal tape measure holder	tunnel	2-1/2" (64 mm)	11" x 10" (279 mm x 254 mm)	1.03



5178

Single-Pocket Tool Pouch

- Leather construction.
- Perfect for carrying pliers and other tools in the hip pocket.
- Prevents wear and tearing of clothes, discomfort, and possible injury.
- Riveted to assure long life.



5111

Cat. No.	Pockets (Total Number)	Overall Size	Weight (lbs.)
5111	1	4-1/2" x 7" (114 mm x 178 mm)	.23

Strap-Leather Bag

- Leather construction.
- Soft, pliable cushion-leather gussets allow expansion to 3-1/4" (83 mm).
- Ventilating eyelet in bottom.



5140K

Cat. No.	Belt Connection	Belt Capacity	Length	Width	Depth	Weight (lbs.)
5140K	latigo thongs	up to 3" (76 mm) wide	7" (178 mm)	9" (229 mm)	3-1/4" (83 mm)	.65

3-Pocket Utility Pouch

- Leather construction.
- Features 1" (25 mm) reinforced gusset.
- Has 2" (51 mm) outside pockets.
- Riveted for extra durability.

Cat. No.	Pockets (Total Number)	Belt Connection	Belt Width	Overall Size	Weight (lbs.)
5145	3	tunnel	1" (25 mm)	5-1/4" x 7" (133 mm x 178 mm)	.46



5145

All dimensions are in inches and (millimeters).



Tool Pouches

4-Pocket Tool Pouch

- Leather construction.
- Riveted and stitched for extra durability.

Cat. No.	Pockets (Total Number)	Specialty Add-Ons	Belt Connection	Belt Width	Overall Size	Weight (lbs.)
5119	4	knife snap	slotted	2" (51 mm)	6-1/2" x 8-1/2" (165 mm x 216 mm)	.39



5119

5-Pocket Tool Pouches

- Cat. No. 5125 is constructed of #4 canvas, leather back, pockets and loops.
- Cat. No. 5125L is constructed of leather.
- General-purpose pouches.
- Heavy-duty chain tape thong securely fastened with a rivet.
- Riveted and stitched for extra durability.



5125



5125L

Cat. No.	Pockets (Total Number)	Specialty Add-Ons	Belt Connection	Belt Width	Overall Size	Weight (lbs.)
5125	5	leather tape thong	loops	2-1/4" (57 mm)	7-1/2" x 8-1/2" (191 mm x 216 mm)	.63
5125L	5	leather tape thong	loops	2-1/4" (57 mm)	7-1/2" x 8-1/2" (191 mm x 216 mm)	.75

5-Pocket Tool Pouch

- Leather construction.
- Riveted to assure long life.



5126

Cat. No.	Specialty Add-Ons	Belt Connection	Belt Width	Overall Size	Weight (lbs.)
5126	knife snap	slotted	2" (51 mm)	6" x 8-3/4" (152 mm x 222 mm)	.74

Leather Back Pocket Pouch

- Leather construction.
- Stitched and riveted to assure long life.
- Snap loop option for belt.
- Six pockets, including scissors pocket on back flap.



5481

Cat. No.	Belt Connection	Belt Width	Overall Size	Weight (lbs.)
5481	snap loop	up to 2" (51 mm)	10" H x 5-3/4" W x 2-1/2" D (254 mm x 146 mm x 64 mm)	.47

6-Pocket Tool Pouches

- Leather construction.
- Riveted to assure long life.

Cat. No.	Pockets (Total Number)	Specialty Add-Ons	Belt Connection	Belt Width	Overall Size	Weight (lbs.)
5127	6	knife snap	slotted	2" (51 mm)	7" x 10" (178 mm x 254 mm)	.79
5127T	6	knife snap	tunnel	2-1/2" (64 mm)	7" x 10" (178 mm x 254 mm)	.87



5127



5127T

All dimensions are in inches and (millimeters).



Tool Pouches

8-Pocket Extra-Capacity Tool Pouch

- Leather construction.
- Extra-capacity multi-purpose pouch.
- Stitched and riveted.

Cat. No.	Pockets (Total Number)	Specialty Add-Ons	Belt Connection	Belt Width	Overall Size	Weight (lbs.)
5162T	8	knife snap, leather tape thong	tunnel	3" (76 mm)	8-1/2" x 10-3/4" (216 mm x 273 mm)	1.71



5162T

8-Pocket Tool Pouches

- Leather construction.
- Riveted to assure long life.

Cat. No.	Pockets (Total Number)	Specialty Add-Ons	Belt Connection	Belt Width	Overall Size	Weight (lbs.)
5164	8	knife snap	slotted	2" (51 mm)	6-3/4" x 9-3/4" (171 mm x 248 mm)	1.16
5164T	8	knife snap	tunnel	2-1/2" (64 mm)	6-3/4" x 9-3/4" (171 mm x 248 mm)	1.21



5164



5164T

10-Pocket Tool Pouch

- Leather construction.
- Riveted and stitched.

Cat. No.	Pockets (Total Number)	Specialty Add-Ons	Belt Connection	Belt Width	Overall Size	Weight (lbs.)
5165	10	knife snap	slotted	2" (51 mm)	10" x 10" (254 mm x 254 mm)	1.26



5165

10-Pocket Tool Pouch

- Leather construction.
- Versatile pouch favored by many telephone installers.
- Riveted throughout to assure long life.
- Ten separate compartments with places for a wide variety of pliers, screwdrivers, and other tools.
- Slotted-leather tape thong (allows easy removal of 1" I.D. tape rolls).

Cat. No.	Pockets (Total Number)	Specialty Add-Ons	Belt Connection	Belt Width	Overall Size	Weight (lbs.)
5190	10	leather tape thong	slotted	1-3/4" (44 mm)	6" x 8-3/4" (152 mm x 222 mm)	.75



5190

All dimensions are in inches and (millimeters).



Tool Pouches

11-Pocket Tool Pouch

- Leather construction.
- Multi-pocketed pouch made for electricians and other professionals.
- Riveted and stitched.
- Stainless steel clip holder accepts most tape clips up to 1-1/4" wide.
- Heavy-duty chain tape thong securely fastened with a rivet.

Cat. No.	Pockets (Total Number)	Specialty Add-Ons	Belt Connection	Belt Width	Overall Size	Weight (lbs.)
5167	11	knife snap, chain tape thong, metal tape measure holder	slotted	2-3/4" (70 mm)	10" x 10-1/2" (254 mm x 267 mm)	1.43



5167

Back Pocket Pouch

- Four pockets, including two open pockets on the front for longer tools such as screwdrivers.
- Cordura® ballistic nylon, a high-performance fabric resistant to abrasions, tears and scuffs.
- Stitched and riveted to assure long life.
- Snap loop option for belt.



Cat. No.	Belt Connection	Belt Width	Length	Width	Depth	Weight
5482	snap loop	up to 2" (51 mm)	9-7/8" (251 mm)	5" (127 mm)	2" (51 mm)	.26 lbs. (0.12 kg)

Cordura® is a registered trademark of INVISTA for durable fabrics.



5482

All-Purpose Bag

- Soft, pliable cushion leather construction.
- Bag is ideal for carrying loose tools and small parts.
- Adjustable belt strap for attaching to belts.



5146

Cat. No.	Belt Connection	Belt Capacity	Length	Width	Depth	Weight (lbs.)
5146	belt strap	up to 3" (76 mm) wide	9"	8"	3"	.60
			(229 mm)	(203 mm)	(76 mm)	

Leather Bolt Bag

- Split-leather construction.
- Bolt bag with bull-pin loop on each side.



42247

Cat. No.	Belt Connection	Belt Capacity	Length	Width	Depth	Weight (lbs.)
42247	tunnel	up to 3" (76 mm) wide	5"	8-1/2"	8-1/2"	.75
			(127 mm)	(216 mm)	(216 mm)	

Canvas Utility Bag

- Heavy No. 8 natural canvas.
- Includes interior pocket.
- Inside bottom is reinforced with cushion leather & ventilating eyelet.
- Metal snaps provided on loops for easy attachment to belts up to 3" (76 mm) wide.
- Top edge reinforced with 1/4" (6 mm) rope.
- Cat. No. 5142P version includes interior pocket.

Cat. No.	Belt Connection	Belt Capacity	Length	Width	Depth	Weight
5141P	loops	up to 3" (76 mm) wide	10"	12"	5"	.88 lbs. (0.40 kg)
			(254 mm)	(305 mm)	(127 mm)	
5142	loops	up to 3" (76 mm) wide	9"	10"	8" x 3"	.60 lbs. (0.27 kg)
			(229 mm)	(254 mm)	(203 mm x 76 mm)	
5142P	loops	up to 3" (76 mm) wide	9"	10"	8" x 3"	.65 (0.29 kg)
			(229 mm)	(254 mm)	(203 mm x 76 mm)	



5141P

5142

All dimensions are in inches and (millimeters).



Tool Pouches

Nut & Bolt Pouch

- Includes interior pocket.
- Top sides of pouch reinforced with leather to maintain shape of pouch opening.
- Inside bottom is reinforced with leather and ventilating eyelet.
- Metal snaps provided on loops for easy attachment to belts up to 3" (76 mm) wide.
- Top edge reinforced with 1/4" (6 mm) rope.

Cat. No.	Interior Pockets	Color	Length	Width	Depth	Weight
51A	1	black	9" (229 mm)	10" (254 mm)	3.5" (90 mm)	1 lbs. (0.45 kg)



51A

Water-Repellent Canvas Pouches

- One-piece tan 12-oz. water-repellent mildew resistant canvas.
- Top edge reinforced with 1/4" (6 mm) rope.

Cat. No.	Belt Connection	Belt Capacity	Length	Width	Top Diameter	Weight
5179	loops	up to 4-1/2" (114 mm) wide	7-1/2" (191 mm)	3-1/2" (89 mm)	7" (178 mm)	.30 lbs. (0.14 kg)
5179S	snap	up to 4-1/2" (114 mm) wide	7-1/2" (191 mm)	3-1/2" (89 mm)	7" (178 mm)	.30 lbs. (0.14 kg)



5179S

5179

Bull-Pin and Bolt Bags

- No. 4 canvas or split-leather with double bottom.
- Bolt bag with bull-pin loop on each side.



5416TC



5416



5416TCP

Cat. No.	Belt Connection	Belt Capacity	Length	Width	Depth	Weight
Canvas						
5416	loops	up to 3" (76 mm) wide	5" (127 mm)	9" (229 mm)	10" (254 mm)	.85 lbs. (0.30 kg)
5416T	tunnel	up to 3" (76 mm) wide	5" (127 mm)	9" (229 mm)	10" (254 mm)	.90 lbs. (0.4 kg)
Canvas - Top Closing						
5416TC	tunnel	up to 3" (76 mm) wide	5" (127 mm)	9" (229 mm)	10" (254 mm)	.87 lbs. (0.39 kg)
5416TCP	tunnel	up to 3" (76 mm) wide	5" (127 mm)	9" (229 mm)	12" (305 mm)	1 lbs. (0.45 kg)
Leather						
5416L	tunnel	up to 3" (76 mm) wide	5" (127 mm)	9" (229 mm)	10" (254 mm)	1.10 lbs. (0.14 kg)

Canvas Electrode Bag

- Made of tough No. 4 canvas.
- Heat-resistant, hard leather bottom.
- Web loop for sliding over belt.



5471

Cat. No.	Diameter	Front Depth	Back Depth	Weight (lbs.)
5471	2-1/2" (64 mm)	12" (305 mm)	15-1/2" (394 mm)	.25

All dimensions are in inches and (millimeters).



Tool Pouches

6-Pocket Nail/Screw and Tool Pouch

- Split-leather construction.
- Heavy hammer-loops on both sides, allowing for convenient use by right- or left-handed workers.
- Riveted and stitched for extra durability.

Cat. No.	Pockets (Total Number)	Specialty Add-Ons	Belt Connection	Belt Width	Overall Size	Weight (lbs.)
42241	6	2 hammer loops	tunnel	3" (76 mm)	11" x 11-3/4" (279 mm x 298 mm)	.86



42241

Tool Combination Aprons

One-Piece Nail/Screw and Tool Pouch Apron

- Split-leather construction.
- Versatile, roomy double-pouch apron for construction workers, carpenters, and other professionals.
- Riveted and stitched for extra durability.
- Four slots for punches or nail sets.
- Two heavy-duty hammer loops.
- Double-pouch design allows unrestricted leg movement.
- Apron is reinforced throughout with rivets.
- The large pockets and nail/bolt pockets have rolled-over, doubled edges for long wear.
- Heavy-duty 2" (51 mm) wide polypropylene web belt has rugged metal buckle.



42242

Cat. No.	Pockets (Total Number)	Size Adjustable	Weight (lbs.)
42242	10	32" - 48" (813 mm - 1219 mm)	1.81

Nail/Screw and Tool Pouch Combinations

- Split-leather construction.
- Large pockets have rolled-over doubled edges for extra-long life.
- All pouches slide along belt for convenient working position.
- Left- and right-hand nail-and-tool pouches.
- Heavy-duty 2" (51 mm) wide polypropylene web belt has rugged metal buckle.
- Tape-rule holder for 20' and 25' tape measures with belt clips.
- Heavy hammer loops.



42244

Cat. No.	Description	Weight (lbs.)
42244	complete combination: belt (Cat. No. 5225 mm), left-hand (Cat. No. 42246 mm) and right-hand (Cat. No. 42245 mm) nail-and-tool pouches, and tape-rule holder (Cat. No. 5195 mm)	2.02
42245	right-hand nail-and-tool pouch only. Tunnel loop fits any belt up to 3" (76 mm) width.	.70
42246	left-hand nail-and-tool pouch only. Tunnel loop fits any belt up to 3" (76 mm) width.	.72
5225	poly-web belt only. Adjustable from 32" (813 mm) to 48" (1219 mm). Tunnel loop fits any belt up to 3" (76 mm) width.	.42
5195	tape-rule holder only for 20' and 25' tapes.	.18

All dimensions are in inches and (millimeters).

⚠ WARNING: The tool belts shown on this page are not occupational protective belts.



Tool Combination Aprons

Electrician's Tool Apron



- Deep pockets to fit your tools.
- Loops for extra tool storage.
- Tape measure holder.
- Special pockets for writing utensils.
- Made of heavy-duty canvas.
- Riveted to assure long life.

42200

Cat No.	Size	Fits Waist Sizes	Weight
42200	M/L	32" - 46" (813 mm - 1,168 mm)	.86 lbs. (0.39 kg)
42201	XL/2XL	38" - 54" (965 mm - 1,372 mm)	.93 lbs. (0.42 kg)

Tool Holders

Scissors Holder — Tunnel

- Leather construction.
- Designed for Klein electrician's scissors, industrial shears, snips and bent trimmers.
- Riveted and stitched for extra durability.



5100M

Cat. No.	Belt Connection	Belt Width	Overall Size	Weight (lbs.)
5100M	tunnel	up to 2" (50.8)	Medium	3.2

Scissors Holder — Slotted

- Leather construction.
- Riveted with clip on back for attaching to belt.
- Designed to hold Klein electrician's scissors, Cat. Nos. 2100-5 and 2100-7.
- Riveted to assure long life.



5101

Cat. No.	Belt Connection	Belt Width	Overall Size	Weight (lbs.)
5101	metal clip	up to 1-1/2" (38 mm)	2" x 7" (51 mm x 178 mm)	.11

Scissors and Cable-Splicer's Knife Holders

- Leather construction.
- Specially designed to hold a pair of Klein electrician's scissors (Cat. Nos. 2100-5 or 2100-7, 2100-8, 2100-9), and Cat. No. 44200 cable-splicer's knife.
- Riveted and stitched for extra durability.



5187

5187T

Cat. No.	Belt Connection	Belt Width	Overall Size	Weight (lbs.)
5187	slotted	up to 2-1/4" (57 mm)	2" x 7-1/4" (51 mm x 184 mm)	.11
5187T	tunnel	up to 2-1/4" (57 mm)	2" x 7-1/4" (51 mm x 184 mm)	.13

Lineman's Knife Holder

- Leather construction.
- Designed for Klein skinning knives Cat. Nos. 1570-3, 1570-3LR, and 1560-3.
- Riveted to assure long life.



5163

Cat. No.	Belt Connection	Belt Width	Overall Size	Weight (lbs.)
5163	slotted	up to 2" (51 mm)	3-1/2" x 9-3/8" (89 mm x 238 mm)	.21

All dimensions are in inches and (millimeters).



Tool Holders

Knife Holder

- Leather construction.
- Designed for utility knives and Klein Cat. Nos. 44100 and 44105.
- Corners riveted and stitched for extra durability.

Cat. No.	Belt Connection	Belt Width	Overall Size	Weight (lbs.)
5185	slotted	up to 2-1/2" (64 mm)	2-5/8" x 8-1/4" (67 mm x 210 mm)	.11



5185

Cable-Splicer's Knife Holders

- Leather construction.
- Designed to hold Cat. No. 44200 cable-splicer's knife.
- Riveted and stitched for extra durability.

Cat. No.	Belt Connection	Belt Width	Overall Size	Weight (lbs.)
5188	slotted	up to 2-1/4" (57 mm)	2-1/8" x 7-3/4" (54 mm x 197 mm)	.08
5188T	tunnel	up to 2-1/4" (57 mm)	2-1/8" x 7-1/4" (54 mm x 184 mm)	.11



5188



5188T

Pliers Holders – Open Bottom

- Leather construction.
- Long-nose pliers may protrude through opening at bottom.
- Riveted to assure long life.
- Cat. No. 5107-6 holds 6" (152 mm) or 7" (178 mm) long-nose or diagonal-cutting pliers.
- Cat. No. 5107-9 holds 8" (203 mm) or 9" (229 mm) long-nose or diagonal-cutting pliers.



5107-6

Cat. No.	Belt Connection	Belt Width	Overall Size	Weight (lbs.)
5107-6	slotted	up to 2" (51 mm)	3-1/2" x 8-1/2" (89 mm x 216 mm)	.17
5107-9	slotted	up to 2" (51 mm)	3-3/4" x 11" (95 mm x 279 mm)	.26

Pliers Holder — Closed Bottom

- Leather construction.
- Nose of pliers does not protrude from closed bottom.
- Bottom is vented to prevent collection of dirt or water.
- Riveted to assure long life.
- Holds 7", 8", or 9" side-cutting pliers.



5112

Cat. No.	Belt Connection	Belt Width	Overall Size	Weight (lbs.)
5112	slotted	up to 2" (51 mm)	3-1/4" x 11" (83 mm x 279 mm)	.21

Pliers, Folding Rule, Screwdriver, and Wrench Holder

- Leather construction.
- No exposed rivets in back.
- Riveted to assure long life.
- Pockets for 7", 8", and 9" side-cutting pliers, most screwdrivers, 6' folding rules, and open-end wrenches from 9/16" to 13/16".
- Nickel plated alloy snap.



5118C

Cat. No.	Pockets (Total Number)	Belt Connection	Belt Width	Overall Size	Weight (lbs.)
5118C	4	slotted	up to 2" (51 mm)	6-1/2" x 11" (165 mm x 279 mm)	.78

Pliers, Rule, and Screwdriver Holders

- Leather construction.
- 3 pockets for pliers, folding rule, and screwdriver.
- S5118PRS has a two-way knife snap.
- Riveted to assure long life.
- Pockets for 7", 8", and 9" side-cutting pliers, most screwdrivers, 6' folding rules, and open-end wrenches from 9/16" to 13/16".



5118PRS

Cat. No.	Belt Connection	Belt Width	Overall Size	Weight (lbs.)
5118PRS	slotted	up to 2" (51 mm)	6-3/4" x 10" (171 mm x 254 mm)	.49
S5118PRS	slotted	up to 2" (51 mm)	6-3/4" x 10" (171 mm x 254 mm)	.56

Tool Pouches, Carriers,
Belts & Suspenders



Tool Holders

4 and 5 Pocket Pouches Lineman's Pouches

- Leather construction with double leather back for durability.
- Rivet hole for belt connection.
- Riveted to assure long life.
- Includes knife snap, pockets for pliers, most screwdrivers, 6' folding rule and open-ended wrenches.



5118P4



5118P5

Cat. No.	Pockets (Total No.)	Belt Connection	Approx. Overall Size	Weight (lbs.)
5118P5	5	rivet hole	10" x 11" (254 mm x 279 mm)	1.13
5118P4	4	rivet hole	8" x 11" (203 mm x 279 mm)	.91

Pliers and Folding Rule Holders

- Leather construction.
- Riveted to assure long life.
- Pockets for 7", 8", or 9" side-cutting pliers and 6-ft. folding rule.

Cat. No.	Pockets (Total Number)	Belt Connection	Belt Width	Overall Size	Weight (lbs.)
5118R	2	slotted	up to 2" (51 mm)	4-3/4" x 8" (121 mm x 203 mm)	.43
5118RT	2	tunnel	up to 3-3/4" (95 mm)	4-1/2" x 12-1/2" (114 mm x 318 mm)	.50



5118R

5118RT

Pliers and Screwdriver Holder

- Leather construction.
- Riveted to assure long life.
- Pockets for 7", 8", or 9" side-cutting pliers and most screwdriver sizes.

Cat. No.	Pockets (Total Number)	Belt Connection	Belt Width	Overall Size	Weight (lbs.)
5118S	2	slotted	up to 2" (51 mm)	4-1/4" x 10-3/4" (108 mm x 273 mm)	.35



5118S

Hammer Holders

- Leather construction.
- Heavy-metal hammer loop riveted to panel.
- Riveted and stitched for extra durability.
- Holds all hammers except lineman's.

Cat. No.	Belt Connection	Belt Width	Overall Size	Weight (lbs.)
5456	slotted	up to 2-1/2" (64 mm)	4-5/16" x 7-7/8" (110 mm x 200 mm)	.33
5456T	tunnel	up to 4" (102 mm)	4-5/16" x 10" (110 mm x 254 mm)	.42
5456TS	tunnel	up to 4" (102 mm)	4-5/16" x 10" (110 mm x 254 mm)	.42



5456

5456T

5456TS

All dimensions are in inches and (millimeters).



Tool Holders

Flashlight Holder

- Leather construction.
- Designed for a standard two-cell flashlight.
- Riveted to assure long life.



5129

Cat. No.	Belt Connection	Belt Width	Overall Size	Weight (lbs.)
5129	slotted	up to 2-1/4" (44 mm)	3" x 9-1/2" (76 mm x 241 mm)	.22

Cordura® Ballistic Nylon Flashlight Holder

- Cordura® ballistic nylon for exceptional resistance to abrasions, punctures and tears.
- Metal belt clip attaches to belts up to 2" wide.
- Secure snap closure.



1106

Cat. No.	Applicable Model	Dimensions H x W x D	Weight (oz.)
1106	X35	9" x 2.75" x 1.88" (22.9 cm x 6.99 cm x 4.78 cm)	3.4

Tape-Rule Holders

- Leather construction.
- Cut-out sides for easy access to tape.
- Slotted for attaching to belts up to 2-1/2" (63 mm) wide.
- Riveted to assure long life.



Cat. No.	Description	Overall Size	Weight (lbs.)
5194	small	4" x 6" (102 mm x 152 mm)	.16
5195	medium	4-1/2" x 7" (114 mm x 178 mm)	.18
5196	large	5" x 7" (127 mm x 178 mm)	.21

Klein Tape-Rule Sizing Guide

Tape Measure	Cat. No.	Description
	5194	small leather pouch
93116	5707	nylon tape measure clip/holder
93025, 93125	5195	medium leather pouch
93225, 93275	5707	nylon tape measure clip/holder
	5196	large leather pouch
93430	5707	nylon tape measure clip/holder
	5712	nylon pouch



5195

Erection Wrench Holder

- Cotton web tunnel loop and leather construction.
- Holds two erection wrenches.
- Riveted to assure long life.
- Holds erection wrenches and adjustable head construction wrench Cat. No. 3239.

Cat. No.	Belt Connection	Belt Width	Overall Size	Weight (lbs.)
5461T	cotton web tunnel	up to 2" (51 mm)	6" x 10" (152 mm x 254 mm)	.26



5461T

Bull-Pin Holders

- Leather construction.
- Holders for Klein bull pins.
- Riveted to assure long life.
- Holds all standard bull pins.



5417

5417T

Cat. No.	Belt Connection	Belt Width	Overall Size	Weight (lbs.)
5417	slotted	up to 2" (51 mm)	3-1/4" x 11" (83 mm x 279 mm)	.22
5417T	tunnel	up to 3-1/2" (89 mm)	3-1/4" x 12-1/4" (83 mm x 311 mm)	.32

Erection Wrench Holders

- Leather construction.
- Has tool slots for two erection wrenches.
- Tunnel loop on Cat. No. 5459T is riveted to assure long life.
- Holds erection wrenches and adjustable head construction wrench Cat. No. 3239.



5460



5459T

Cat. No.	Belt Connection	Belt Width	Overall Size	Weight (lbs.)
5460	slotted	up to 2" (51 mm)	6" x 8-1/2" (152 mm x 216 mm)	.19
5459T	tunnel	up to 3-1/2" (89 mm) or to slide over D-rings, buckles, and other accessories	6" x 9-1/2" (152 mm x 241 mm)	.32



Tool Holders

Tape Thong

- Leather strap with fiber bar.
- Fits all standard electrical tape rolls.



5130

Cat. No.	Belt Connection	Length	Weight (lbs.)
5130	slotted	12" (305 mm)	.03

Tie-Wire Reel Pad

- Worn on the belt under the Klein tie-wire reel.
- Made of 3/16" (5 mm) thick rigging leather.
- Slots accommodate belts up to 2" (51 mm) wide.
- Underside has a sponge-rubber pad to minimize hip fatigue.
- Holds Cat. No. 27400 tie-wire reel.
- To be used with Cat. Nos. 5415 or 5420 belts.



27450

Cat. No.	Length	Width	Weight (lbs.)
27450	7" (178 mm)	7" (178 mm)	.300

Tie-wire reel and ironworker's heavy-duty tie-wire belts also available.

Two-Way Snap

- Leather construction.
- Screw-type rivets for easy attachment to belts.



5131

Cat. No.	Belt Connection	Length	Weight (lbs.)
5131	screw rivets	4-1/2" (114 mm)	.10

Snap Loop

- Leather construction.
- Designed for tools with hang holes.
- Loop with snap hook for carrying an adjustable wrench, welder's igniter or other tool with hang hole.
- Riveted to assure long life.



5458

Cat. No.	Belt Connection	Belt Width	Overall Size	Weight (lbs.)
5458	slides on	up to 4" (102 mm)	1-1/2" x 8-1/2" (38 mm x 216 mm)	.15

Tool Guards

Axe Guard



5509

- Protect both tool and user with a Klein guard for your edged tools.
- Made of 1/16" (1.6 mm) vulcanized hard fiber, securely riveted and equipped with adjustable web straps to hold the tool.

Cat. No.	Description	Weight (lbs.)
5509	axe guard	.22

Splitting-Knife Guards

- Leather construction.



5574L

5574S

Cat. No.	Description	Weight (lbs.)
5574L	leather splitting or chipping-knife guard. Fits Klein knife, Cat. No. 1515-1	.13
5574S	leather splitting or chipping-knife guard. Fits Klein knife, Cat. No. 1515-S	.05

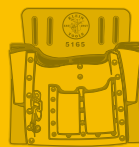

Tradesman Pro™

Tradesman Pro™ Organizer – Electrician's Tool Belt



55427

- 26 pockets for easy tool storage.
- Wide open pockets for tools, drills and spare parts.
- Removable pouches allow you to carry only the tools needed.
- Exclusive drill bit pocket.
- Handles for easy carrying.
- Loop tape measure holder.
- Padded belt with mesh interior is breathable and comfortable.
- Rugged leather belt ends.
- Attachments for Tradesman Pro™ padded suspenders (Cat. No. 55400).



Exclusive drill bit pocket

Cat. No.	Size	Weight
55427	31" – 34" (787 mm – 864 mm)	4.15 lbs. (1.88 kg)
55428	35" – 39" (889 mm – 991 mm)	4.16 lbs. (1.89 kg)
55429	40" – 44" (1016 mm – 1118 mm)	4.30 lbs. (1.95 kg)

Tradesman Pro™ Padded Suspenders

- Made of tear resistant Cordura®.
- Fully adjustable.
- Durable nylon web straps for long wear.
- Heavy duty padding for comfort.
- Easy snap hook fastening system.
- Designed for use with Tradesman Pro™ Organizer electrician's tool belt (Cat. Nos. 55427, 55428, 55429).

Cat. No.	Size	Weight
55400	one size fits most	.84 lbs. (.38 kg)

Cordura® is a registered trademark of INVISTA for durable fabrics.

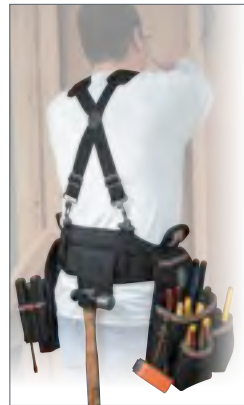

55400

Tool Pouches, Carriers,
Belts & Suspenders



Tradesman Pro™ Mobile Phone Holders

- Cat No. 55460 Fits iPhone® 4 and 5, and similar sized phones.
- Cat No. 55461 Fits Samsung Galaxy S® 3 and 4, and similar sized phones.
- Metal clip for attaching to belts up to 2" wide.
- Magnetic flap closure.
- Constructed of 1680d ballistic weave.

Cat. No.	Width	Height	Depth	Weight
55460	3.00" (76 mm)	5.75" (146 mm)	1.50" (38 mm)	0.22 lbs. (0.10 kg)
55461	3.25" (84 mm)	5.875" (149 mm)	1.50" (38 mm)	0.26 lbs. (0.12 kg)

iPhone® is a registered trademark of Apple, Inc.

Galaxy S® is a registered trademark of Samsung Electronics Co., Ltd.



55460

Tradesman Pro™ Carrying Cases

- Two layers of padding protect even delicate instruments.
- Heavy-duty zipper and rugged PVC coated polyester for durability.
- One interior and one exterior pocket for quick access and organization.
- Sturdy handle with box stitching for secure transportation and convenient hanging. Constructed of 1680d ballistic weave.
- Cat. Nos. 69406 and 69407 recommended for meters, testers, infrared guns and small tools.
- Cat. No. 69408 is recommended for meters, testers, borescopes, infrared guns and tools.



69406



69407



69408

Cat. No.	Pockets	Width	Height	Depth	Weight
69406	1	4.50" (114 mm)	9.25" (235 mm)	2.25" (57 mm)	0.38 lbs. (0.17 kg)
69407	2	6.00" (152 mm)	10.25" (260 mm)	2.25" (57 mm)	0.53 lbs. (0.24 kg)
69408	2	7.00" (178 mm)	10.25" (260 mm)	2.25" (57 mm)	0.66 lbs. (0.30 kg)



Features:

Constructed of double layered 1000 denier Cordura® Nylon.

Double nylon-stitched and rivet reinforced for extra durability.

Lightweight and comfortable in warm climates, soft and pliable in cold climates.

Oversized pockets and reinforced bottom for extra carrying capacity, as well as durability.

PowerLine™
Series

Exceptional resistance to abrasion, punctures, and tearing.

No break-in period; naturally forms and hugs the body, making it easy to wear for everyday use.

Heavy-duty, nylon webbing.

Washable.



Cordura® is a registered trademark of INVISTA for durable fabrics.



Tool Pouches



5700



5701



5702



5703

Cat. No.	Pockets (Total Number)	Overall Size	Weight (lbs.)
5700	9	11" x 12" (279 mm x 305 mm)	.92
5701	8	11" x 12" (279 mm x 305 mm)	.83
5702	2	11" x 12" (279 mm x 305 mm)	.64
5703	3	11" x 12" (279 mm x 305 mm)	.75
5718	8	11" x 12" (279 mm x 305 mm)	.74
5719	18	11" x 12" (279 mm x 305 mm)	.87

Cordura® is a registered trademark of INVISTA for durable fabrics.



5718



5719

All dimensions are in inches and (millimeters).

Tool Pouches, Carriers,
Belts & Suspenders

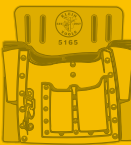

PowerLine™ Series

**PowerLine™
Series**

Closeable Pouch

Additional Feature:

- Closeable pouch helps protect supplies and tools.



5714

Cat. No.	Belt Connection	Belt Width	Overall Size	Weight (lbs.)
5714	tunnel	up to 2-1/4" (57 mm)	7-1/2" x 6-3/4" (190 mm x 171 mm)	.24

Hammer Holder

Additional Feature:

- Heavy-metal hammer loop riveted for additional strength.



5706

Cat. No.	Belt Connection	Belt Width	Overall Size	Weight (lbs.)
5706	tunnel	up to 2-1/4" (57 mm)	4-1/8" x 5" (105 mm x 127 mm)	.19

Tape Measure Holder

Additional Features:

- Holds most tape measures with belt clips.
- Stainless steel clip holder accepts most tape clips up to 1-3/4" wide.



5707

Cat. No.	Belt Connection	Belt Width	Overall Size	Weight (lbs.)
5707	tunnel	up to 2-1/4" (57 mm)	4-1/8" x 3-3/4" (104 mm x 95 mm)	.10

Multi-Purpose Holder

Additional Feature:

- Holds a flashlight, cellular phone, or electrical tester



5708

Cat. No.	Belt Connection	Belt Width	Overall Size	Weight (lbs.)
5708	tunnel	up to 2-1/4" (57 mm)	3-1/4" x 8-1/2" (83 mm x 216 mm)	.13

Tape Measure Pouch

Additional Features:

- Holds most 35-foot tape measures, fasteners, nails, or wire nuts.
- Two inside elastic loops fit screwdrivers, pencils, markers, etc.



5712

Cat. No.	Belt Connection	Belt Width	Overall Size	Weight (lbs.)
5712	tunnel	up to 2-1/4" (57 mm)	8-1/4" x 4-1/2" (210 mm x 114 mm)	.24

Flashlight Holder

Additional Feature:

- Accommodates most "D" cell size battery flashlights up to 1-7/8" in diameter.
- Heavy-duty, 1-1/2" wide nylon webbing for extra strength.



5713

Cat. No.	Belt Connection	Belt Width	Overall Size	Weight (lbs.)
5713	tunnel	up to 2-1/4" (57 mm)	4-1/4" x 2-3/8" (108 mm x 60 mm)	.06

Utility Knife Holder

Additional Feature:

- Holds standard utility knife or other small tools.



5716

Cat. No.	Belt Connection	Belt Width	Overall Size	Weight (lbs.)
5716	tunnel	up to 2-1/4" (57 mm)	7-3/4" x 2-1/2" (197 mm x 64 mm)	.15

Adjustable Web Work Belt

Additional Feature:

- Heavy-duty, 2" wide nylon webbing for extra strength.
- Accommodates tunnel loop and slotted tool pouches and holders.
- Rugged metal buckle for quick release and adjustment.



5705

⚠ WARNING: This is NOT an occupational protective belt. NOT for fall arrest or back support

Cat. No.	Size	Width	Weight (lbs.)
5705	one size fits up to 54" waist	2" (51 mm)	.56

All dimensions are in inches and (millimeters).



Padded Tool Belts

Additional Features:

- 5" cushioned pad for stability and comfort.
- Tapered front for comfort while bending.
- Heavy-duty 2" wide nylon web belt with rugged metal buckle.



5717

Cat. No.	Size	Weight (lbs.)
5717	one size fits most	.84

Velcro® is a registered trademark of Velcro Industries B.V.

Padded Suspenders

Additional Features:

- Fully adjustable length – front & back.
- Heavy-duty, 1-1/2" wide nylon web strap for extra strength and long wear.
- Convenient fastening system features genuine VELCRO® brand touch fasteners.
- Heavy-duty padding for user comfort.



5704L

Cat. No.	Size	Width	Weight (lbs.)
5704M	32" – 36" (813 mm – 914 mm)	2" (51 mm)	.95
5704L	36" – 40" (914 mm – 1016 mm)	2" (51 mm)	1.00
5704XL	40" – 44" (1016 mm – 1118 mm)	2" (51 mm)	1.05

4-Piece Combo Sets

Set consists of the following pieces:

- 8-Pocket Tool Pouch (Cat. No. 5701).
- 3-Pocket Utility Pouch (Cat. No. 5703).
- Hammer Holder (Cat. No. 5706).
- Padded Tool Belt (Cat. No. 5704).



5709L

Cat. No.	Size	Width of Belt	Weight (lbs.)
5709M	32" – 36" (813 mm – 914 mm)	2" (51 mm)	2.71
5709L	36" – 40" (914 mm – 1016 mm)	2" (51 mm)	2.77
5709XL	40" – 44" (1016 mm – 1118 mm)	2" (51 mm)	2.80

4-Piece Electrician's Combo Sets

Set consists of the following pieces:

- 8-Pocket Tool Pouch (Cat. No. 5718).
- 19-Pocket Tool Pouch (Cat. No. 5719).
- Hammer Holder (Cat. No. 5706).
- Padded Tool Belt (Cat. No. 5704).



5710M

Cat. No.	Size	Width of Belt	Weight (lbs.)
5710M	32" – 36" (813 mm – 914 mm)	2" (51 mm)	2.75
5710L	36" – 40" (914 mm – 1016 mm)	2" (51 mm)	2.80
5710XL	40" – 44" (1016 mm – 1118 mm)	2" (51 mm)	3.05

All dimensions are in inches and (millimeters).

▲WARNING: This is NOT an occupational protective belt.

▲WARNING: NOT for fall arrest or back support.

Tool Pouches, Carriers,
Belts & Suspenders

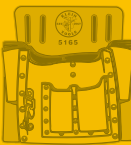

Tool Belts

Lightweight Tool Belt

- Leather construction.
- Designed to carry lightweight tool pouches.

Cat. No.	Size	Width	Weight (lbs.)
5201	33" – 45" (838 mm – 1143 mm)	1" (25 mm)	.30



5201

General-Purpose Belts

- Strong, heavy-duty leather.
- Removable single-tongue buckle held by two heavy-duty snaps.

Cat. No.	Size	Width	Weight (lbs.)
5202M	32" – 40" (813 mm – 1016 mm)	1-1/2" (38 mm)	.40
5202L	38" – 46" (965 mm – 1168 mm)	1-1/2" (38 mm)	.45
5202XL	46" – 54" (1168 mm – 1372 mm)	1-1/2" (38 mm)	.50



5202L

Lightweight Utility Belt

- Strong, lightweight polypropylene web.
- Quickly adjusts for waist sizes through 52" (1321 mm).
- Accepts tunnel-loop and slotted pouches and holders.
- Tough, molded, non-metallic, slide-action buckle provides single-handed, quick release and adjustment.

Cat. No.	Color	Size	Width	Weight (lbs.)
5204	blue	one size fits all	2" (51 mm)	.20



5204

Adjustable Web Tool Belt

- Fits waist sizes up to 48".
- Accommodates tunnel loop and slotted tool pouches and holders.
- 2" wide polypropylene webbing.
- Rugged metal buckle for quick release and easy adjustment.
- Corrosion resistant hardware.

Cat. No.	Size	Width	Weight (lbs.)
5225	48" (1219 mm)	2" (51 mm)	.60



5225

Heavy-Duty Embossed Tool Belts

- Strong, heavy-duty rigging-leather.
- Equipped with a double-tongue buckle.

Cat. No.	Size	Width	Weight (lbs.)
5415S	32" – 40" (813 mm – 1016 mm)	2" (51 mm)	.63
5415	36" – 44" (914 mm – 1118 mm)	2" (51 mm)	.64
5415L	40" – 48" (1016 mm – 1219 mm)	2" (51 mm)	.64
5415XL	44" – 52" (1118 mm – 1321 mm)	2" (51 mm)	.65



5415

All dimensions are in inches and (millimeters).

▲WARNING: This is NOT an occupational protective belt.

▲WARNING: NOT for fall arrest or back support.

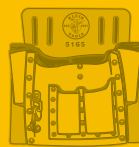

Tool Belts

Cotton/Polyester Blend Tool Belt w/Quick-Release Buckle

- NOT an occupational protective belt. ONLY use as a tool belt.
- Features a forged, quick-release buckle for emergency situations where the user has to quickly disengage the belt (for example, when working over water or in grain elevators).
- Must be worn over the user's harness and clothing so it will drop free when released.
- Belt is made of a mildew-resistant blend of cotton/polyester webbing for comfort and strength.



5425M

Cat. No.	Size	Weight (lbs.)
5425M	30" - 44" (762 mm - 1118 mm)	1.53
5425XL	38" - 58" (965 mm - 1473 mm)	1.67

Designed for Quick Release

1. Pull free end of release strap to disengage other end from retainer.
2. Pulling action rotates clasp to open position.
3. Disengaged clasp allows belt to separate.

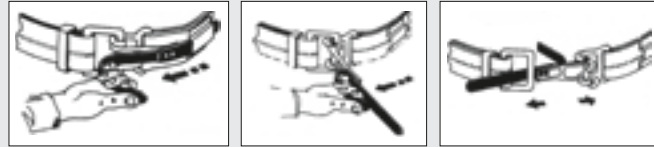

Ironworker's Heavy-Duty Tie-Wire Belts

Ironworker's Heavy-Duty Tie-Wire Belts

- Leather construction.
- Rugged 2" (51 mm) wide belt.
- Has separate reel-strap with its own buckle that lets you quickly and conveniently put on or take off a Klein tie-wire reel and optional pad without removing the belt or your tool pouch.
- Strong double-tongue buckle with keeper.
- Embossed basket-weave pattern.



5420L

Cat. No.	Waist Size	Belt Size Range	Width	Weight (lbs.)
5420S	36" (914 mm)	32" - 40" (813 mm - 1016 mm)	2" (51 mm)	.85
5420	40" (1016 mm)	36" - 44" (914 mm - 1118 mm)	2" (51 mm)	.95
5420L	44" (1118 mm)	40" - 48" (1016 mm - 1219 mm)	2" (51 mm)	1.05
5420XL	48" (1219 mm)	44" - 52" (1118 mm - 1321 mm)	2" (51 mm)	1.15

Tie-wire reel and tie-wire pad also available.

Sets

10 Pocket Tool Pouch and Belt Set

- Combines the popular Cat. No. 5165, leather 10 pocket pouch, and Cat. No. 5202, general purpose leather belt, into one item.
- Belt is embossed to guide cutting and reduce size from large to medium.
- Belt fits 32" to 46" waist sizes (813 mm - 1,168 mm) and is 1-1/2" (38 mm) wide.
- Four large capacity utility pockets, two pliers pockets, four screwdriver loops and knife snap.
- Pouch is riveted and stitched to assure long life.
- Top grain leather construction.

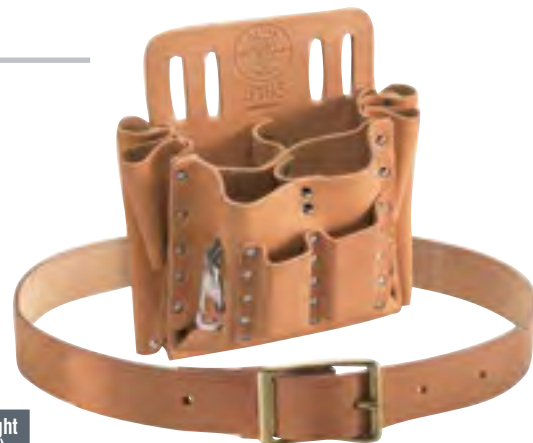

55210

Cat. No.	Belt Width	Overall Size	Pockets	Size	Specialty Add-Ons	Weight (lbs.)
55210	1-1/2" (38 mm)	10" x 10" (254 mm x 254 mm)	10	32" - 46" (813 mm - 1168 mm)	knife snap	1.2

All dimensions are in inches and (millimeters).

⚠WARNING: This is NOT an occupational protective belt.

⚠WARNING: NOT for fall arrest or back support.

All dimensions are in inches and (millimeters).



Suspenders

Suspenders

- Clips and slides are nickel-plated for corrosion resistance.
- Extra-strong belt clips have alligator teeth for added gripping power.
- One size fits all.

Cat. No.	Color	Strap Width	Leather-Back Strap Spreader	Weight (lbs.)
Nylon-Web Suspenders				
60210B	blue	2" (51 mm)	adjustable	.63
Elastic-Back Suspenders				
60223B	blue	2" (51 mm)	non-adjustable	.60



60223B

Suspender Accessories

Leather Cushion Belt Pads

- Deluxe leather pad is 4" (102 mm) wide.
- Thick leather back with four snap-open straps for easy attachment to any belt up to 2" (51 mm) wide.
- Sponge-padded leather liner has rounded edges, and is permanently stitched to the back.
- The most durable, most comfortable pad to wear, especially for prolonged work periods.
- When sizing a belt to accommodate this pad, add 2" to 4" to the belt waist size.

Cat. No.	Length	Width	Weight (lbs.)
87904	22" (559 mm)	4" (102 mm)	.99
87906	30" (762 mm)	4" (102 mm)	1.04



87904

All dimensions are in inches and (millimeters).

▲WARNING: This is NOT an occupational protective belt.

▲WARNING: NOT for fall arrest or back support.





TRADESMAN PRO™ ORGANIZERS

WHY PUT Your Klein® Tools
IN ANYTHING LESS!



KLEIN TOOLS 

For Professionals... Since 1857®

www.kleintools.com



Tool Bags & Storage

Tool bags from Klein come in a wide variety of shapes and sizes to match the diverse tools and accessories professionals use every day.

For Professionals... Since 1857®



Electrician's Bags

NEW!

Tradesman Pro™ Organizer – Rolling Tool Bag

- Rugged 6-Inch wheels easily handle rough terrain.
- Load tested up to 200 lbs.
- Top has reinforced metal frame that stays open for easy loading/unloading.
- Heavy-duty telescoping handle.
- Withstands cold conditions.
- Orange interior for easy tool visibility.

Cat. No.	Length	Width	Height	Pockets	Weight
55452RTB	19" (483 mm)	12-1/2" (318 mm)	14" (356 mm)	24	19 lbs. (8.62 kg)



Molded kick plate to protect from the elements.



Wide open interior to accommodate large tools.



55452RTB

Tradesman Pro™ Organizer – Hacksaw Electrician's Bag

- Fits standard hacksaws up to 16.5".
- Tough, durable molded bottom can withstand cold conditions.
- 1680D ballistic weave for durability.
- Orange interior for easy tool visibility.

Cat. No.	Length	Width	Height	Pockets	Weight
55453HSB	17-3/4" (451 mm)	13-1/2" (368 mm)	14-1/2" (368 mm)	48	8.15 lbs. (3.70 kg)



Top-loading hacksaw pocket with protective plastic lining.



55453HSB

Tradesman Pro™ Organizer – Attachable Hacksaw Holder

- Quick link for attaching to tool bags.
- Fits standard hacksaws up to 16.5".
- Protective plastic lined interior.
- Top-loading for easy access to hacksaw.
- Web strap with snap closure keeps hacksaw secure.
- 1680D ballistic weave for durability.

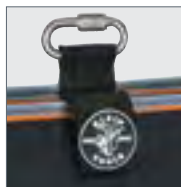

55454DHB

All dimensions are in inches and (millimeters).



Electrician's Bags

NEW!

Tradesman Pro™ Organizer – Tech Backpack

- Storage for adapters and cables.
- Organizer pocket for pens, phone, cables, and more.
- 25 pockets for tons of tool storage.
- Tough, durable molded bottom protects from the elements.
- Hard, molded front pocket protects safety glasses.
- 1680D ballistic weave for durability.

Cat. No.	Length	Width	Height	Interior Pockets	Exterior Pockets	Weight
55456BPL	14" (355.6 mm)	7" (177.8 mm)	18" (457.2 mm)	34	5	5.34 (lbs.) 2.42 (kg)



55456BPL



Separate compartment keeps laptop protected from other tools.



Orange interior to find tools faster.

Tradesman Pro™ Organizer – Tech Bag

- Inside pocket for adapters and cables.
- Zipper pocket for files and paperwork.
- 22 pockets for plenty of tool storage.
- Rubber feet and water resistant material on bottom protects from the elements.
- 1680D ballistic weave for durability.
- Shoulder strap and handles for easy carrying.

Cat. No.	Length	Width	Height	Interior Pockets	Exterior Pockets	Weight
55455M	19" (484.5 mm)	6.5" (165.1 mm)	16" (406.4 mm)	2	53	8.92 (lbs.) 4.04 (kg)



55455M



Separate compartment keeps laptop protected from other tools.



Orange interior to find tools faster.



Electrician's Bags

Tradesman Pro™ Organizer – Electrician's Backpack

- 39 pockets for tons of tool storage.
- Orange interior for easy tool visibility.
- Wide opening fits power drills, meters, flashlights, etc.
- Tough, durable bottom protects from the elements.
- Large front pocket easily fits cables and tools.
- 1680D ballistic weave for durability.

Cat. No.	Length	Width	Height	Interior Pockets	Exterior Pockets	Weight
55421-BP	14" (355.6 mm)	7" (177.8 mm)	18" (457.2 mm)	34	5	5.34 (lbs.) 2.42 (kg)

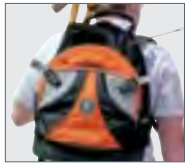

Large front pocket easily fits fish tapes or tools and cables.



55421-BP

Tradesman Pro™ Organizer – Ultimate Electrician's Bag

- 55 pockets for ultimate tool organization.
- Orange interior for easy tool visibility.
- Wide opening fits power drills, meters, laptops, etc.
- Tough, durable molded bottom protects from the elements.
- 1680D ballistic weave for durability.
- Shoulder strap and handles for easy carrying.

Cat. No.	Length	Width	Height	Interior Pockets	Exterior Pockets	Weight
55418-19	19" (444.5 mm)	6.5" (254 mm)	16" (355.6 mm)	53	2	8.92 (lbs.) 4.04 (kg)



55418-19

Tradesman Pro™ Organizer – Extreme Electrician's Bag

- 78 pockets for extreme tool storage.
- Orange interior for easy tool visibility.
- Wide center with removable pockets for easy access to tools.
- Tough, durable molded bottom protects from the elements.
- 1680D ballistic weave for durability.
- Shoulder strap and handles for easy carrying.

Cat. No.	Length	Width	Height	Interior Pockets	Exterior Pockets	Weight
55417-18	17.5" (482.6 mm)	10" (165.1 mm)	14" (406.4 mm)	53	25	9.51 (lbs.) 4.31 (kg)



55417-18

All dimensions are in inches and (millimeters).



Electrician's Bags

Tradesman Pro™ Organizer – Shoulder Pouch

- 16 pockets for better tool storage.
- Orange interior for easy tool visibility.
- Tough, durable rubber feet protect from the elements.
- 1680D ballistic weave for durability.
- Shoulder strap and handle for easy carrying.

Cat. No.	Length	Width	Height	Interior Pockets	Exterior Pockets	Weight
55419-SP	8" (203.2 mm)	5" (127 mm)	10" (254 mm)	9	7	2.2 (lbs.) 1 (kg)



Rubber feet protect the bottom surface from the elements.



55419-SP

Tradesman Pro™ Organizer – 8-Inch Tote

- 20 pockets for greater tool storage.
- Orange interior for easy tool visibility.
- Removable zipper bag designed to fit compartment underneath.
- Tough, durable feet protect from the elements.
- 1680D ballistic weave for durability.
- Handle for easy carrying.

Cat. No.	Length	Width	Height	Interior Pockets	Exterior Pockets	Weight
55415-8	8" (203.2 mm)	8" (203.2 mm)	17" (431.8 mm)	9	11	4.77 (lbs.) 2.16 (kg)



Removable zipper bag designed to fit compartment underneath.



55415-8

Tradesman Pro™ Organizer – 10-Inch Tote

- 40 pockets for maximum tool storage.
- Orange interior for easy tool visibility.
- Removable zipper bag designed to fit compartment underneath.
- Tough, durable feet protect from the elements.
- 1680D ballistic weave for durability.
- Shoulder strap and handles for easy carrying.

Cat. No.	Length	Width	Height	Interior Pockets	Exterior Pockets	Weight
55416-10	10" (254 mm)	10" (254 mm)	12" (304.8 mm)	18	22	5.16 (lbs.) 2.34 (kg)



Removable zipper bag designed to fit compartment underneath.



55416-10

All dimensions are in inches and (millimeters).



Tool Bags

Canvas Tool Bags

- Heavy-duty No. 8 natural canvas.
- Rivet-reinforced for durability.
- Steel-frame mouth with hinge for rugged use.
- Stitched and riveted leather handles for comfort and strength.
- Two retaining straps with buckles provide secure closure.
- Bottom and lower sides are covered with moisture-resistant vinyl.
- Non-scratch studs on base protect against wear.
- Shoulder strap kit available (Cat. No. 5102S).

Cat. No.	Length	Width	Height/Depth	Weight (lbs.)
5102-12	12" (305 mm)	6" (152 mm)	10" (254 mm)	2.14
5102-14	14" (356 mm)	6" (152 mm)	14" (356 mm)	2.55
5102-16	16" (406 mm)	6" (152 mm)	14" (356 mm)	3.05
5102-18	18" (457 mm)	6" (152 mm)	14" (356 mm)	2.84
5102-20	20" (508 mm)	6" (152 mm)	15" (381 mm)	3.16
5102-22	22" (559 mm)	6" (152 mm)	15" (381 mm)	3.48
5102-24	24" (610 mm)	6" (152 mm)	15" (381 mm)	4.10



5102-12

Deluxe Canvas Tool Bags

- Multiple interior pockets for organization.
- Detachable shoulder strap can be adjusted for a perfect fit.
- Made of heavy-duty No. 8 natural canvas.
- Moisture-resistant vinyl bottom with non-scratch studs on the base to protect against wear.
- Steel frame mouth with hinge for rugged use.
- Stitched and riveted leather handles for long life.

Cat. No.	Length	Width	Height/Depth	Pockets	Weight (lbs.)
5102-14SP	12" (305 mm)	6" (152 mm)	10" (254 mm)	10	2.14
5102-16SP	14" (356 mm)	6" (152 mm)	14" (356 mm)	13	2.55
5102-18SP	16" (406 mm)	6" (152 mm)	14" (356 mm)	13	3.05
5102-24SP	18" (457 mm)	6" (152 mm)	15" (381 mm)	17	2.84



5102-16SP

High-Bottom Canvas Tool Bags

- Heavy-duty No. 8 natural canvas.
- Bottom and 8" (203 mm) of lower sides are covered with moisture-resistant vinyl.
- Non-scratch studs on base protect against wear.
- Steel-frame mouth with hinge for rugged use.
- Harness-leather handles with two retaining straps and buckles.
- Retro-fit bags with shoulder strap kit (Cat. No. 5102S). Kit includes leather strap with pad and snap hooks, rings and fasteners for attaching rings to bags.

Cat. No.	Length	Width	Height/Depth	Weight (lbs.)
5105-20	20" (508 mm)	6" (152 mm)	15" (381 mm)	3.55
5105-24	24" (610 mm)	6" (152 mm)	15" (381 mm)	4.00



5105-20



Tool Bags

Canvas Tool Bags – Multiple Pockets, Leather Bottom

- Steel-frame mouth with hinge for rugged use.
- Internal pockets in a variety of sizes.
- External pocket for additional carrying needs.
- Constructed of strong No. 8 natural canvas.
- Reinforced bottom supports heavy tools, blocks moisture, and provides durability at wear points.
- Wide opening provides easy access to large tools.
- Bottom is protected from the elements by 6 studs.
- Includes: Shoulder strap mounts, (optional shoulder strap available, Cat. No. 58889) external pocket, leather bottom and 3" (76 mm) of sides covered with black leather, 2" (51 mm) wide web handles, leather handle wrap, and external tool loop handle in the webbing.



5003-18

Cat. No.	Length	Width	Height/Depth	Interior Pockets	Exterior Pockets	Retaining Straps	Weight (lbs.)
5003-18	18" (457 mm)	6" (152 mm)	14" (356 mm)	10	1	1	4.14
5003-20	20" (508 mm)	6" (152 mm)	15" (381 mm)	14	1	2	4.38

Cordura® Ballistic Nylon Tool Bag

- Cordura® ballistic nylon, a high-performance fabric resistant to abrasions, tears and scuffs.
- Molded bottom made with a durable, impact modified polypropylene.
- Eight interior and two exterior pockets hold a wide assortment of hand tools and supplies.
- Large opening with reinforced steel frame maintains the bag's shape while loading and unloading.
- Heavy-duty nylon zipper closure and a large leather zipper-pull assure easy operation.
- Box-stitched 2" (51 mm) wide polypropylene padded carrying handles with comfortable leather wrap.
- Optional padded, slip-resistant adjustable shoulder strap (Catalog No. 58889) for hands-free mobility is available.



5200-15

Cat. No.	Length	Width	Height/Depth	Weight (lbs.)
5200-15	15" (381 mm)	8" (203 mm)	14-1/2" (368 mm)	3.59

Cordura® is a registered trademark of INVISTA for durable fabrics.

Canvas Tool Bags

- Heavy-duty No. 6 natural canvas.
- Double-layer canvas bottom.
- Reinforced, riveted web handles.

Cat. No.	Length	Width	Height/Depth	Weight (lbs.)
5155	17" (432 mm)	9" (229 mm)	12" (305 mm)	1.56
5156	19" (483 mm)	9" (229 mm)	15" (381 mm)	1.82



5155

All dimensions are in inches and (millimeters).



Tool Bags

Vinyl Equipment Bags

- Wide bag opening easily accommodates helmets and other equipment.
- Two large, outside pockets with Velcro® fastening (Cat. No. 5182BLA).
- Durable, double-stitched plastic bottom.
- Webbing extends down side of bag from handles and shoulder strap for extra support & durability.
- Right-sized rain flap with Velcro® fastening.
- Adjustable, padded shoulder strap included.



5181ORA



VELCRO® is a registered trademark of Velcro Industries B.V.



5182BLA

Cat. No.	Exterior Pockets	Shoulder Strap	Color	Length	Height	Width	Weight (lbs)
5182BLA	2	Yes	black	24" (610 mm)	20" (508 mm)	10" (254 mm)	7.00
5181ORA	1	Yes	orange	24" (610 mm)	20" (508 mm)	10" (254 mm)	7.00

Lineman Backpack

- Wide opening easily accommodates helmets, belts, and other equipment.
- Large front pocket for separate storage of gaffs, rubber gloves or other equipment.
- Durable, double stitched plastic bottom with drain holes.
- Rain flap for top of pack.
- Adjustable padded shoulder straps with adjustable waist strap.
- Padded back area.

Cat. No.	Length	Width	Height/Depth	Interior Pockets	Exterior Pockets	Weight (lbs.)
5185ORA	18" (457mm)	10" (254 mm)	23" (584 mm)	1	3	5.80



5185ORA

Extra-Large Vinyl Equipment Bag

- Orange vinyl-coated polyester fabric bag.
- Bottom extends 3" (76 mm) up the sides.
- Bottom of bag is protected by metal studs.
- Bottom reinforced with 1/4" (6 mm) plywood.
- Nylon-web handles extend around bag for extra support.
- Wide opening steel frame is securely riveted in top of bag.
- Extra flap for storm protection.



5180

Cat. No.	Length	Width	Height/Depth	Weight (lbs.)
5180	24" (610 mm)	10" (254 mm)	18" (457 mm)	6.00

All dimensions are in inches and (millimeters).



Tool Bags

Tool Totes™

- Constructed of rugged, 600 x 300 denier polyester to resist wear and tear on the jobsite.
- 2" wide (51 mm), polypropylene padded carrying handles with comfortable leather wrap.
- Water-resistant to avoid the build-up of mold and mildew.
- Exterior pockets hold a variety of tools and a mobile phone.
- Multiple interior pockets and a large interior compartment for a wide assortment of tools and supplies (only with Cat. No. 58888 and Cat. No. 58890).
- Durable molded bottom with drain holes to prevent water retention.
- Contoured, padded, slip-resistant shoulder strap for hands-free mobility (included with 58888 and 58890).
- Heavy-duty chain tape thong (58890 only).



58890

Cat. No	Interior Pockets	Exterior Pockets	Chain Tape Thong	Shoulder Strap (Cat. No. 58889)	Length	Width	Height/Depth	Weight (lbs.)
58886	-	7	No	No*	15-1/2" (394 mm)	7-1/2" (191 mm)	10" (254 mm)	2.42
58888	5	7	No	Yes	15-1/2" (394 mm)	7-1/2" (191 mm)	10" (254 mm)	3.01
58890	7	10	Yes	Yes	15-1/2" (394 mm)	7-1/2" (191 mm)	10" (254 mm)	3.41

*Optional shoulder strap (Cat. No. 58889) available.

Tool Organizer

- Constructed of double-layered, 600 x 300 denier polyester to resist wear and tear on the jobsite.
- Water-resistant to avoid the buildup of mold and mildew.
- Double layer of polyester at bucket edges for durability.
- Interior pockets include: three tool sleeves, one power tool/cord sleeve, and six universal pockets.
- Exterior pockets include: nine screwdriver/nut driver pockets, eleven pliers pockets, eleven utility pockets, two wire stripper pockets, and two Velcro® closeable pockets.
- Heavy-duty webbing keeps pockets open for easy access to supplies and tools.



5777

Cat. No.	Interior Pockets	Exterior Pockets	Nominal Size	Weight (lbs.)
5777	10	35	fits standard 5-gallon buckets	3.90

VELCRO® is a registered trademark of Velcro Industries B.V.
Tools NOT included.

Ten-Compartment Drawstring Bag

- 12-oz. olive canvas.
- Ten compartments to hold small parts.
- Drawstring for easy closing.

Cat. No.	Diameter	Height/Depth	Weight (lbs.)
5151	11" (279 mm)	6" (152 mm)	.41



5151



Tool Bags

Deluxe Leather Bags

- Rugged tool bag made of extra-heavy leather.
- Removable, padded shoulder strap.
- Three-ply bottom with steel studs.
- Retaining straps extend around bag for extra support.

Cat. No.	Length	Width	Height/Depth	Weight (lbs.)
5108-18	18" (457 mm)	7" (178 mm)	8" (203 mm)	4.77
5108-20	20" (508 mm)	7" (178 mm)	8" (203 mm)	5.17
5108-24	24" (610 mm)	7" (178 mm)	8" (203 mm)	5.50



5108-18

Leather Tote Bag

- Rugged tool bag made of extra-heavy leather.
- Stitched and riveted construction.
- Reinforced ends.
- Double-ply bottom with steel studs.

Cat. No.	Length	Width	Height/Depth	Weight (lbs.)
5115	15" (381 mm)	6-1/2" (165 mm)	7" (178 mm)	2.20



5115

Contractor's Zipper Portfolios

- Great for transporting contracts, quotations, work orders, plans, and schedules.
- Holds clipboards, binders, and mobile phones.
- Convenient storage for pliers, wrenches, screwdrivers, nut drivers, other tools and spare parts.
- Heavy-duty zipper.
- Overall size: 17" (432mm) long x 12" (305mm) high.

Cat. No.	Material	Color	Zipper	Weight (lbs.)
5136	Top Grain Leather	brown	brass	.84
5236	Cordura® Ballistic Nylon	black	nylon	.51
5336	No. 10 Canvas	natural	brass	.40

Cordura® is a registered trademark of INVISTA for durable fabrics.



5136

Zipper Bag – Top-Grain Leather

- Brushed cowhide leather with heavy-duty brass zipper.
- Convenient storage for pliers, wrenches, screwdrivers, nut drivers, other tools, and spare parts.

Cat. No.	Length	Height	Weight (lbs.)
5139L	12-1/2" (318 mm)	7" (178 mm)	.23



5139L

All dimensions are in inches and (millimeters).



Tool Bags

Zipper Bags



5139



5139B



5139C

- Constructed of No. 10 canvas with heavy-duty brass zipper (Cat. No. 5139).
- Convenient storage for pliers, wrenches, screwdrivers, nut drivers, other tools, and spare parts.
- Constructed of Cordura® ballistic nylon, a high-performance fabric resistant to abrasions, tears, and scuffs (Cat. Nos. 5139B, 5139C).
- Heavy-duty nylon zipper. (Cat. Nos. 5139B, 5139).
- Features the jungle stalker digitized camouflage pattern for maximum concealment (Cat. Nos. 5139C).
- Heavy-duty nylon stitching and zipper ensure durability and long life (Cat. Nos. 5139C).

Cat. No.	Material	Length	Height	Weight (lbs.)
5139	canvas	12-1/2" (318 mm)	7" (178 mm)	.19
5139B	Cordura® Ballistic Nylon	12-1/2" (318 mm)	7" (178 mm)	.24
5139C	Cordura® Camouflage	12-1/2" (318 mm)	7" (178 mm)	.14
5139L	Leather	12-1/2" (318 mm)	7" (178 mm)	.23

Cordura® is a registered trademark of INVISTA for durable fabrics.

Padded Cordura® Zipper Bag

- Constructed of Cordura®, a high performance fabric resistant to abrasions, tears, and scuffs.
- Three-layer padding provides additional protection to contents.
- Heavy-duty nylon zipper.
- Overall size: 12-1/2" (318 mm) x 7" (178 mm).

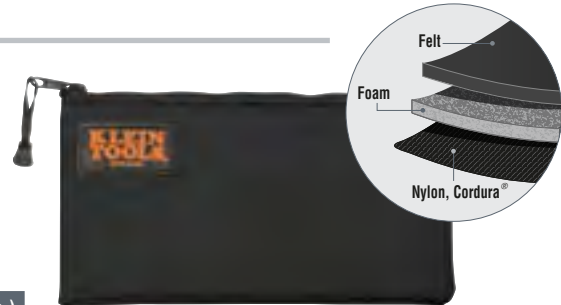

Cat. No.	Material	Length	Height	Color	Weight (lbs.)
5139PAD	Cordura® Ballistic Nylon	12 -1/2" (318 mm)	7" (178 mm)	black	.28

Cordura® is a registered trademark of INVISTA for durable fabrics.

5139PAD

Zipper Bags – Canvas, 4-Pack

- Includes four assorted colors to organize and categorize important tools.
- Constructed of No. 10 canvas with heavy-duty brass zipper.

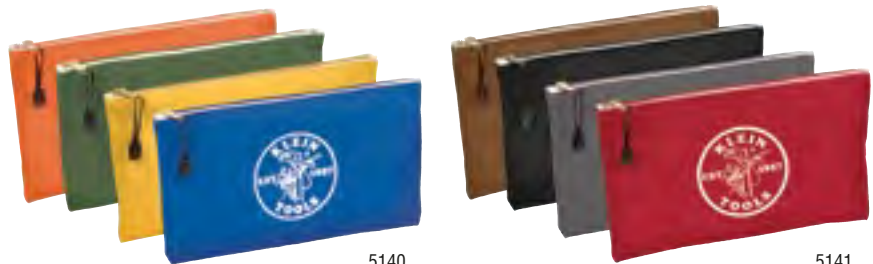

5140

5141

Cat No.	Description	Weight (lbs.)
5140	4 zipper bags - olive, orange, royal blue, yellow	.80
5141	4 zipper bags - brown, black, gray, red	.80

- Convenient storage for pliers, wrenches, screwdrivers, nut drivers, other tools and spare parts.
- Overall size: 12-1/2" (318 mm) long x 7" (178 mm) high.

Canvas Zipper Bags – Consumables

- Constructed of No. 8 canvas, with heavy-duty brass zipper.
- Convenient storage for wire nuts, connectors and other consumables.
- 3-1/2" wide bottom for stability when standing; easy access when open.
- Brass grommet for hanging or attaching to belt or clip.
- Overall size: 10" (254 mm) long x 8" (203 mm) tall x 3-1/2" (89 mm) wide.

Cat. No.	Material	Length	Height	Width	Color	Weight (lbs.)
5539RED	canvas	10" (254 mm)	8" (203 mm)	3- 1/2" (89 mm)	red	.25
5539BLU	canvas	10" (254 mm)	8" (203 mm)	3- 1/2" (89 mm)	blue	.25
5539YEL	canvas	10" (254 mm)	8" (203 mm)	3- 1/2" (89 mm)	yellow	.25
5539NAT	canvas	10" (254 mm)	8" (203 mm)	3- 1/2" (89 mm)	natural	.25
5539CPAK	canvas	see above	see above	see above	3-pack: red, blue, yellow	.75



5539BLU

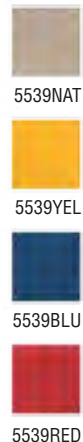

5539RED

All dimensions are in inches and (millimeters).



Tool Bags

Glove Bags — Canvas

- Made of durable canvas.
- Has an expansion gusset, 5-1/2" (140 mm) across the top and 2-3/4" (70 mm) at bottom.
- Brass grommets in bottom for ventilation.
- Supplied with two-way snap.
- Includes safety notice to remind workers of the importance of using gloves.

Cat. No.	Canvas	Length	Width	Top Depth	Bottom Depth	Weight (lbs.)
5121-15	No. 4	15" (381 mm)	8" (203 mm)	5-1/2" (140 mm)	2-3/4" (70 mm)	.74
5121-19	No. 4	19" (483 mm)	8" (203 mm)	5-1/2" (140 mm)	2-3/4" (70 mm)	.88
5124-15	No. 10	15" (381 mm)	8" (203 mm)	4" (100 mm)	4" (100 mm)	.60
5124-17	No. 10	17" (432 mm)	8" (203 mm)	4" (100 mm)	4" (100 mm)	.65
5124-19	No. 10	19" (483 mm)	8" (203 mm)	4" (100 mm)	4" (100 mm)	.70



5121-15

Combination Glove and Sleeve Bags

- Panels are tough No. 4 canvas.
- Provides separate storage for gloves and sleeves.
- Brass grommets in bottom for ventilation.
- Bags are 8" (203 mm) wide.
- Supplied with two-way snap.
- Includes safety notice to remind workers of the importance of using gloves.

Cat. No.	Length	Width	Bottom Depth	Weight (lbs.)
5122-16	16" (406 mm)	8" (203 mm)	4-13/16" (122 mm)	.98
5122-18	18" (457 mm)	8" (203 mm)	4-13/16" (122 mm)	1.05



5122-16

Tool Bag Accessories

Shoulder Strap Kit

- Adjustable leather shoulder strap for Cat. Nos. 5102 and 5105 series canvas tool bags.
- Complete kit contains leather strap with pad and snap hooks, rings and fasteners for attaching rings to bags.

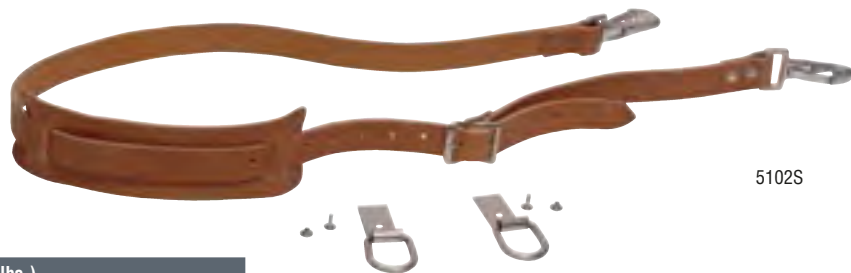

5102S

Cat. No.	Weight (lbs.)
5102S	.78

Padded Adjustable Shoulder Strap

- Shoulder strap for Tool Tote™ and 5003 series canvas tool bags.
- Adjustable from both ends for a perfect fit.



Cat. No.	Weight (lbs.)
58889	.36

58889

All dimensions are in inches and (millimeters).



Metal Tool Box & Slide Racks

Extra-Deep All-Purpose Tool Box

- A popular choice for all-around use.
- Big-capacity box with the necessary strength and rigid construction.
- Heavy-duty three-compartment tote tray with big, easy-grip handle.
- Double drawbolts plus hasp and staple for padlocks up to 3/8" (10 mm) in diameter (padlock not included).
- Protective, red, baked-enamel finish.



54401

Cat. No.	Length	Depth	Height	Weight (lbs.)
54401	20" (508 mm)	8" (196 mm)	9" (220 mm)	11.55



Slide Racks

- Holds Klein mid-size or extra-large storage boxes.
- Boxes not included with rack, must be ordered separately.
- Welded, extra-rigid, all-steel construction.
- Metallic-gray, baked-enamel finish.
- Boxes ride in and out on heavy-duty channel tracks that permit covers to open all the way for full access.
- Heavy tabs prevent boxes from being accidentally pulled out, yet allow boxes to be easily removed when desired.
- Locking bars can be readily attached to prevent unauthorized access.



54474

Cat. No.	Holds	Length (Front to Back)	Width	Height	Weight (lbs.)
54474	4 Klein mid-size storage boxes	11-3/4" (298 mm)	15-1/4" (387 mm)	10-3/4" (273 mm)	20.30
54476	6 Klein mid-size storage boxes	11-3/4" (298 mm)	15-1/4" (387 mm)	16-3/8" (416 mm)	28.75
54477	4 Klein extra-large storage boxes	15-3/4" (400 mm)	20" (508 mm)	15" (381 mm)	37

Slide-Rack Locking Bars

- Steel bars lock to secure mid-size storage boxes in slide racks.
- Front hasp pivots down to allow locking bar to open.
- Available for Klein four-box and six-box racks.
- Strong piano hinge.
- Metallic-grey baked-enamel finish.
- Mounting holes allow for easy installation with sheet metal screws or pop rivets.



54484

Cat. No.	Description	Weight (lbs.)
54484	locking bar for Cat. No. 54474 slide rack	.25
54486	locking bar for Cat. Nos. 54476 & 54477 slide racks	.35

All dimensions are in inches and (millimeters).



Extra-Large Parts Storage Boxes & Slide Racks

Extra-Large Compartment Boxes

- Klein storage boxes are offered with a choice of compartment sizes and arrangements.
- Boxes feature strong, rigid, heavy-duty welded construction.
- Full-length piano hinged covers are designed to stay open for ease of access.
- Each box has a carrying handle, positive pull-down locking catch.
- Boxes have a heavy, metallic-gray baked-enamel finish.
- Box compartments feature high-impact styrene construction.
- Scoop-bottom design for easy parts removal and cleaning.
- Fits four-drawer extra-large slide rack Cat. No. 54477.



54445

Cat. No.	Number of Compartments	Compartment Sizes	Length (Front to Back)	Width	Height	Weight (lbs.)
54445	16	4-3/8" x 2-7/8" (111 x 73 mm)	12" (305 mm)	18" (457 mm)	3" (76 mm)	7.55
54446	21	20 each 2-3/4" x 2-7/8" (70 x 73 mm) and one 3-3/4" x 11-7/8" (95 x 302 mm)	12" (305 mm)	18" (457 mm)	3" (76 mm)	7.60
54447	24	20 each 2-3/4" x 2-7/8" (70 x 73 mm) and four 3-3/4" x 2-7/8" (95 x 73 mm)	12" (305 mm)	18" (457 mm)	3" (76 mm)	7.95
54448	32	32 each 2-1/8" x 2-7/8" (54 x 73 mm)	12" (305 mm)	18" (457 mm)	3" (76 mm)	8.00

Adjustable-Compartment Parts Box

- Movable dividers in this parts box allow compartment sections to be arranged and sized as desired.
- Three partitions, running from front to back, divide the box into four equal 4-1/2" x 12" (114 mm x 305 mm) sections.
- Nine straight metal dividers can be positioned anywhere between the partitions, in one-inch (25 mm) increments, to create the compartments desired.
- Boxes feature strong, rigid, heavy-duty welded construction.
- Full-length piano hinged covers are designed to stay open for ease of access.
- Each box has a carrying handle, positive pull-down locking catch.
- Boxes have a heavy, metallic-gray baked-enamel finish.
- Box compartments feature high-impact styrene construction.
- Scoop-bottom design for easy parts removal and cleaning.
- Fits four-drawer extra-large slide rack Cat. No. 54477.



54451

Cat. No.	Description	Length (Front to Back)	Width	Height	Weight (lbs.)
54451	adjustable-compartment parts drawer with 3 fixed partitions and 9 movable dividers	12" (305 mm)	18" (457 mm)	3" (76 mm)	7.65



Lineman Buckets & Accessories

Klein lineman buckets and accessories have been recognized for decades for their durability and dependability. They are built for strength to handle professional wear and tear.

For Professionals... Since 1857®

Lineman Buckets & Accessories



Canvas Buckets

Features:

Rope handle reinforced with leather for water resistance and strength.

Durable, straight-wall and tapered-wall buckets are made of heavy-duty canvas.



The "No" refers to the canvas weight. No. 1 being the thickest and No. 10 being the thinnest.

High-density polyethylene top ring for strength and chemical resistance.

WARNING:

- Inspect for damage before each use.
- Remove from service if bucket shows signs of wear.
- Never exceed the working load limit.
- Completely close top before each use.

Leather-Bottom Buckets

Additional Features:

- Load Rated 100 lbs.
- No. 1 canvas.
- Leather reinforced bottom.
- Leather cuff extends 3" (76 mm) up the side.
- Inside pocket measures 8" x 8" (203 mm x 203 mm).
- Rope handle.

Cat. No.	Diameter	Height	Extra Features	Weight (lbs.)
5104	12" (305 mm)	17" (432 mm)		2.71
5104S	12" (305 mm)	17" (432 mm)	swivel snap (Cat. No. 2012)	2.93
5104VT	12" (305 mm)	17" (432 mm)	VELCRO® closure	3.0



5104



5104VT

Straight-Wall Buckets

Additional Features:

- No. 6 canvas.
- Black molded polypropylene bottom.
- Rope handle.



5106

Cat. No.	Diameter	Height	Extra Features	Weight (lbs.)
5106	9" (229 mm)	14" (356 mm)	N/A	1.51
5106P	9" (229 mm)	14" (356 mm)	two 7" x 7" (178 mm x 178 mm) inside pockets	1.62
5106S	9" (229 mm)	14" (356 mm)	swivel snap (Cat. No. 2012)	1.80

Wide Opening Straight-Wall Buckets

Additional Features:

- Load Rated 75 lbs.
- No. 6 canvas.
- Black molded polypropylene bottom.
- Rope handle.



5109

Cat. No.	Diameter	Height	Extra Features	Weight (lbs.)
5109	12" (305 mm)	15" (381 mm)	N/A	2.06
5109P	12" (305 mm)	15" (381 mm)	one 8" x 8" (203 mm x 203 mm) inside pocket	2.12
5109S	12" (305 mm)	15" (381 mm)	swivel snap (Cat. No. 2012)	2.35
5109PS	12" (305 mm)	15" (381 mm)	one 8" x 8" (203 mm x 203 mm) inside pocket and swivel snap (Cat. No. 2012)	2.40

All dimensions are in inches and (millimeters).



Canvas Buckets

Vinyl Bucket Top

- Top cover for canvas bucket designed to keep the elements out and tools securely inside.
- Compatible with Klein Tools 5104 and 5109 series buckets.
- Attaches with VELCRO®.
- Includes safety strap loop to ensure connection to bucket.
- Bucket not included.



51TOP

Cat. No.	Diameter	Height	Weight (lbs)
51TOP	12.5" (318 mm)	3.5" (89 mm)	.4

Tapered-Wall Buckets

Additional Features:

- No. 6 canvas.
- Black molded polypropylene bottom.
- Rope handle.



5113

Cat. No.	Top Diameter	Bottom Diameter	Height	Extra Features	Weight (lbs.)
5113	12" (305 mm)	9" (229 mm)	13" (330 mm)		1.55
5113S	12" (305 mm)	9" (229 mm)	13" (330 mm)	swivel snap (Cat. No. 2012)	1.84

Heavy-Duty Tapered-Wall Bucket

Additional Features:

- No. 4 canvas.
- Black molded polypropylene bottom.
- Rope handle.
- Riveted leather glove strap.
- Equipped with Cat. No. 2012 swivel snap hook.



5103S

Cat. No.	Top Diameter	Bottom Diameter	Height	Extra Features	Weight (lbs.)
5103S	12" (305 mm)	9" (229 mm)	12" (305 mm)	swivel snap (Cat. No. 2012)	1.95

Heavy-Duty Tapered-Wall Buckets with Pockets

Additional Features:

- No. 4 canvas.
- Black molded polypropylene bottom.
- Rope handle.
- Riveted leather glove strap.
- Equipped with Cat. No. 2012 swivel snap hook.

Cat. No.	Top Diameter	Bottom Diameter	Height	Outside Pockets	Extra Features	Weight (lbs.)
5171PS	12" (305 mm)	9" (229 mm)	12" (305 mm)	4 outside pockets	swivel snap (Cat. No. 2012)	2.20
5172PS	12" (305 mm)	9" (229 mm)	12" (305 mm)	15 inside pockets	swivel snap (Cat. No. 2012)	2.35



5171PS



5172PS

Oval Bucket with Pockets

Additional Features:

- No. 6 canvas.
- Black molded polypropylene bottom.
- Sisal-rope handle.
- Tripod suspension rope for greater stability.
- Equipped with Cat. No. 2012 swivel snap hook.

Cat. No.	Length	Width	Height	Pockets	Extra Features	Weight (lbs.)
5144S	14" (356 mm)	7" (177 mm)	10" (254 mm)	15 inside pockets	swivel snap (Cat. No. 2012)	2.17
5152S	14" (356 mm)	7" (177 mm)	10" (254 mm)	26 inside pockets & 15 outside pockets	swivel snap (Cat. No. 2012)	2.46



5144S



5152S

All dimensions are in inches and (millimeters).



Canvas Buckets

Features:



LOAD RATED

⚠WARNING:

- Inspect for damage before each use.
- Remove from service if bucket shows signs of wear
- Never exceed the working load limit.
- Completely close top before each use.

A strong reinforced web strap extends down the side of the bucket for extra weight capacity.

Heavy Duty Top Closing Bucket

- Load rated 150 lbs.
- Top of bucket zips closed.
- 14" diameter accommodates standard 5 gallon bucket.
- Body constructed of heavy-duty No. 1 canvas.
- Web strap extends down the side of the bucket.
- Leather reinforced bottom extends 3" up the side.
- Durable steel rim.



Holds 5 gallon bucket



5104CLR17

5104CLR22

Cat. No.	Diameter	Height	Weight
5104CLR17	14" (356 mm)	17" (439 mm)	6.70 lbs. (3.04 kg)
5104CLR22	14" (356 mm)	22" (559 mm)	6.95 lbs. (3.15 kg)

All Purpose Work Bucket

- Load rated: 150 lbs.
- Web strap extends down the side of the bucket.
- Heavy duty plastic bottom with drain holes.

Cat. No.	Diameter	Height	Weight
5109SLR	12" (305 mm)	15" (381 mm)	5.95 lbs. (2.70 kg)



5109SLR



Canvas Buckets

Aerial-Basket Oval Bucket with 15 Interior Pockets

Additional Features:

- No. 6 canvas.
- Black molded polypropylene bottom.
- Two nylon 66 polymer hooks (Cat. No. 5144H) included with Cat. No. 5144.

Cat. No.	Length	Width	Height	Pockets	Extra Features	Weight (lbs.)
5144	14" (356 mm)	7" (177 mm)	10" (254 mm)	15 inside pockets	two hooks (Cat. No. 5144H)	2.01
5144B	14" (356 mm)	7" (177 mm)	10" (254 mm)	15 inside pockets		1.5



5144

Hard Body Oval Buckets

- Fabric constructed of rugged denier polyester to resist wear and tear on the jobsite (Cat. No. 5144BHB14OS).
- Black molded polypropylene bottom with drain holes.
- Cat. No. 5144H hooks sold separately.



5144BHB



5144BHB14OS



5144BHHB



Kick Stand
on back of
Cat. No. 5144BHB

Cat. No.	Pockets	Handle	Color	Length	Height	Width	Weight (lbs)
5144BHB	14	No	orange	14" (356 mm)	10" (254 mm)	7" (178 mm)	2
5144BHHB	14	Yes	orange	14" (356 mm)	10" (254 mm)	7" (178 mm)	2
5144BHB14OS	29	Yes	black	14" (356 mm)	10" (254 mm)	7" (178 mm)	3

Hard Body Oval Bucket with Knife Sheath

- Includes leather skinning knife sheath and 14 other interior pockets.
- Orange, non-conductive plastic exterior maintains bucket shape.
- Fabric constructed of rugged denier polyester to resist wear and tear on the jobsite.
- Black molded polypropylene bottom with drain holes.
- Cat. No. 5144H hooks sold separately.



Knife Sheath
inside of
Cat. No. 5144HBS

Cat. No.	Interior Pockets	Handle	Color	Length	Height	Width	Weight (lbs)
5144HBS	15	Yes	orange	14" (356 mm)	10" (254 mm)	7" (178 mm)	2



5144HBS

All dimensions are in inches and (millimeters).



Canvas Buckets

Line-Hose Bag

- No. 6 canvas with Cyclac top ring and molded bottom.
- Large enough to accommodate several pieces of hose.
- Can also be used to raise protective rubber blankets that are rolled.
- Leather cuff extends 3" (76 mm) up the side.
- Polypropylene rope handle is reinforced with leather.

Cat. No.	Diameter	Depth	Weight (lbs.)
5110-48	7" (178 mm)	48" (1219 mm)	1.91



5110-48

Canvas Electrode Bag

- Made of tough No. 4 canvas.
- Heat-resistant, hard leather bottom.
- Canvas loop for sliding over belt.



5471

Cat. No.	Diameter	Depth	Weight (lbs.)
5471	2-1/2" (64 mm)	15-1/2" (394 mm)	.25

Canvas Tapered-Bottom Bag

- No. 10 canvas.
- Two pockets are provided for small parts.
- Bottom is tapered so parts will stay in center.
- Equipped with a snap for hanging.



5143

Cat. No.	Diameter	Depth	Weight (lbs.)
5143	6-1/2" (165 mm)	8" (203 mm)	.30



Lineman Accessories

Aerial Aprons

- Includes: ten hand tool pockets, two pouches, hammer loop and two drill bit holders (Cat. Nos. 51829, 51829M).
- Two pouches reinforced with heavy duty rivets.
- Cat. No. 5144H hooks sold separately.
- Hot stick pocket (Cat. No. 51829MHS).



Sewn-in magnet conveniently holds nuts, bolts and other small metal objects

Cat. No.	Interior Pockets	Magnet	Color	Width	Height	Weight (lbs.)
51829	18	No	orange	24" (609 mm)	23" (584 mm)	4
51829M	18	Yes	orange	24" (609 mm)	23" (584 mm)	4
51829MHS	16	Yes	orange	32" (813 mm)	27.5" (699 mm)	4

Hooks

Swivel Snap Hook

Additional Features:

- This is NOT an occupational protective hook. NOT for human support.
- Bronze swivel snap hook made for use on canvas buckets.
- Maximum safe load is 150 lbs. (68 kg).



2012

Cat. No.	Length	Width	Weight (lbs.)
2012	4-3/8" (111 mm)	1-5/8" (41 mm)	.28

Hook for Aerial-Baskets

- All weather, durable, nylon 66 polymer.
- Most manufacturers' aerial basket trucks accommodate bucket hook.
- Replacement hook for both Cat. No. 5144.



5144H

Cat. No.	Weight (lbs.)
5144H	.30

Slings

Pole Sling

- For use where a running loop wrap around pole is desired.
- Nylon web stitched with nylon thread.
- NOT an occupational protective device. NOT for human support.



5606

Cat. No.	Rated Capacity (Maximum Working Load)		Overall Length	Width	Weight (lbs.)
	Choke Hitch	Basket Hitch			
5606	3000 lbs (1350 kg)	4700 lbs (2115 kg)	39" (991 mm)	2" (51 mm)	1.33

All dimensions are in inches and (millimeters).

⚠WARNING: This is NOT an occupational protective device. NOT for human support.



UTILITY STORAGE



Innovative and practical solutions to haul utility tools and gear

KLEIN TOOLS 
For Professionals... Since 1857®

Lineman Buckets
& Accessories



Block & Tackle

Klein's line of block and tackle is engineered for high-strength requirements.

For Professionals... Since 1857®



Block and Tackle

- These are NOT occupational protective devices. NOT for human support.
- Sheaves are strong, yet are lightweight aluminum alloy with all-bronze bushings.
- Light, galvanized-steel shell blocks are fitted with snubbing hooks to hold the load.
- Hooks fit under insulator and engage pin on cross arm.
- All Klein block and tackle use high-quality, 3/8" diameter rope.

- Available with standard snap hooks or guarded snap hooks (with snap hook nose lengthened to extend over the latch or keeper).
- Choice of forged hook Cat. No. 258 or swivel hook Cat. No. 259.
- Catalog numbers followed by S/R have rope spliced to block.
- Maximum safe load is 750 lbs. (338 kg).

Anchor Hook

- Forged hook is designed to fit under insulator and engage pin of cross arm.
- Maximum safe load 750 lbs. (340 kg).
- Standard on Klein block & tackle Cat. Nos. 1802-30 and H1802-30.



258

Cat. No.	Eye I.D.	Throat Opening	Overall Length	Weight (lbs.)
258	5/8" (16 mm)	1-7/8" (48 mm)	5-1/2" (140 mm)	.42

Swivel Anchor Hook

- Swivel clevis on this forged hook will engage with snap on Klein block & tackle Cat. Nos. 1802-30 and H1802-30.
- Swivel prevents twisting and kinking of rope.
- Maximum safe load 750 lbs. (340 kg).



259

Cat. No.	Swivel Opening	Throat Opening	Overall Length	Weight (lbs.)
259	1-3/16" x 1" (30 mm x 25 mm)	1-7/8" (48 mm)	6-1/2" (165 mm)	.40

Heavy-Duty Snap Hook

- Snaps on with one hand.
- Forged hook may be used on many conventional steel blocks, 4" (102 mm) or smaller.
- Maximum safe load 8000 lbs. (3629 kg).



455

Cat. No.	Eye I.D.	Throat Opening	Overall Length	Weight (lbs.)
455	15/16" (24 mm)	1" (25 mm)	5" (127 mm)	.84

Rope



- Works with all block and tackle products.
- High-quality, 3/8" diameter rope.

Cat. No.	Diameter	Average Strength	Minimum Strength	Overall Length	Weight (lbs.)
48502	3/4" (9 mm)	3,600 (1600 kg)	3,200 (1500 kg)	25' (7,620 mm)	.78

Blocks

- Blocks without ropes and hooks.
- Made of light galvanized steel and aluminum alloy.
- Sheaves have bronze bushings.



267



268



H267



H268

Cat. No.	Description	Weight (lbs.)
267	plain block	.76
H267	Cat. No. 267, but nose extends over keeper	.80
268	block with eye to splice line to block and rope tie-off	.91
H268	Cat. No. 268, but nose extends over keeper	1.00

All dimensions are in inches and (millimeters).

WARNING: These are NOT occupational protective devices. Do NOT use for human support.



Block and Tackle Packages

Block and Tackle with Standard Hooks



Cat. No.	Component Part Number				Rope spliced to component number	Weight (lbs.)
	267 Block	268 Block	258 Anchor Hook	259 Swivel Anchor Hook		
1802-30	•	•	•			2.80
1802-30 S/R	•	•	•		268 Block	2.80
1802-30S	•	•		•		2.85
1802-30S S/R	•	•		•	268 Block	2.85



1802-30

1802-30 S/R



1802-30S

1802-30S S/R

All dimensions are in inches and (millimeters).

WARNING: These are NOT occupational protective devices. Do NOT use for human support.



Block and Tackle Packages

Block and Tackle with Guarded Hooks

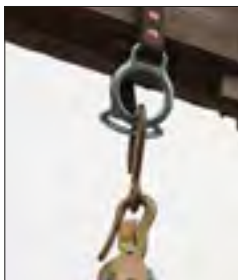

Cat. No.	Component Part Number				Rope spliced to component number	Weight (lbs.)
	H267 Block	H268 Block	258 Anchor Hook	259 Swivel Anchor Hook		
H1802-30	●	●	●			2.90
H1802-30 S/R	●	●	●		H268 Block	2.90
H1802-30 S	●	●		●		3.00
H1802-30S S/R	●	●		●	H268 Block	3.00



H1802-30



H1802-30 S/R



H1802-30S



H1802-30S S/R

All dimensions are in inches and (millimeters).

WARNING: These are NOT occupational protective devices. Do NOT use for human support.



Block and Tackle

Polypropylene Hand-Lines with Snap Hook



1804-60

- Made of 5/16" (8 mm) three-strand polypropylene rope spliced to eye of snap hook.
- Both lines 75' (23 m) long.
- Forged steel with swivel clevis and quick-acting plunger-style latch.

Cat. No.	Description	Weight (lbs.)
1803-60	75' (23 m) of 5/16" (8 mm) rope with Cat. No. 443A snap. Maximum safe load 250 lbs. (113 kg)	2.45
1804-60	75' (23 m) of 5/16" (8 mm) rope with Cat. No. 470 swivel snap. Maximum safe load 250 lbs. (113 kg)	2.20

Howe Wire Tool

- Strap is made of tough Klein-Kord®.
- Swivel hook is forged steel with large opening.
- Shank of hook is lengthened to reach under insulator.
- Other end has device to hold the load at any distance.
- All metal parts are galvanized.
- Max. safe load 500 lbs. (225 kg).



1702-20N

Cat. No.	Description	Weight (lbs.)
1702-20N	nylon strap 1" (25 mm) wide, 7' (2.1 m) long	1.95

Snap Hook

- General-purpose forged snap hook with eye at 90° to opening.
- Maximum safe load 1500 lbs. (675 kg).



443A

Cat. No.	Eye I.D.	Throat Opening	Overall Length	Weight (lbs.)
443A	1" (25 mm)	1/2" (13 mm)	5-1/2" (140 mm)	.52

Swivel Hook with Plunger Latch

- Forged steel with swivel clevis and quick-acting plunger-style latch.
- Designed to take 1/2" (13 mm) or lighter hand lines.
- Swivel action prevents accidental fouling into secondary wires.
- Maximum safe load 750 lbs. (338 kg).



470

Cat. No.	Swivel Opening	Throat Opening	Overall Length	Weight (lbs.)
470	1-3/16" x 1" (30 mm x 25 mm)	5/8" (16 mm)	5" (127 mm)	.30

Web Strap Ratchet Hoist

NEW!

- Large, non-conductive drum knob allows web slack to be adjusted with ease.
- 360° handle rotation.
- 3/4 ton single line and 1-1/2 ton double line load rating.
- Tight ratcheting mechanism allows precise tensioning.
- Meets ANSI/ASME B30.21-2005 & B30.10-2009 standards.

Cat. No.	Pull Type	Approx. Weight Each
KN1500P-EX	Single/Double	1.95

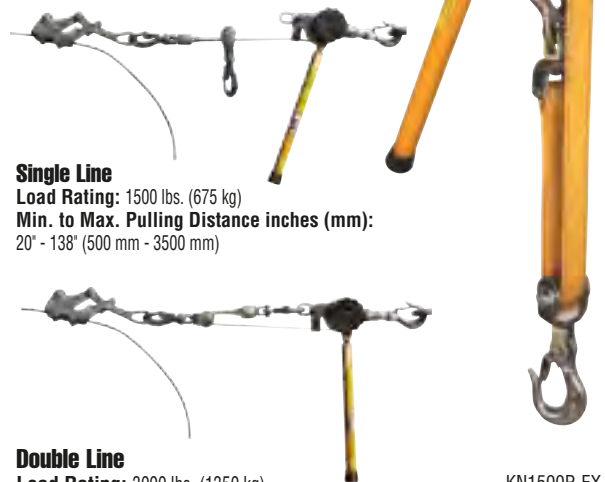

Single Line
Load Rating: 1500 lbs. (675 kg)
Min. to Max. Pulling Distance inches (mm):
 20" - 138" (500 mm - 3500 mm)

Double Line
Load Rating: 3000 lbs. (1350 kg)
Min. to Max. Pulling Distance inches (mm):
 26" - 79" (700 mm - 2000 mm)

KN1500P-EX

All dimensions are in inches and (millimeters).

⚠WARNING: These are NOT occupational protective devices. Do NOT use for human support.



Wire Pulling Grips

Klein combines strength and durability to create an extremely high-quality line of grips. With ease-of-use and reliability, Klein wire-pulling grips set the mark.

F O R P R O F E S S I O N A L S S I N C E 1 8 5 7 ®

Wire Pulling Grips



Introduction to Wire Pulling Grips

Quality

Trust the quality and reliability of Klein Grips. All authentic Klein Grips are manufactured, inspected and tested in the USA, in company owned plants by American workers. From the custom drop-forged quality steel to machining and heat treating, to pulling rated load and final inspection, Klein Grips are designed to help linemen get their jobs done.

Features:

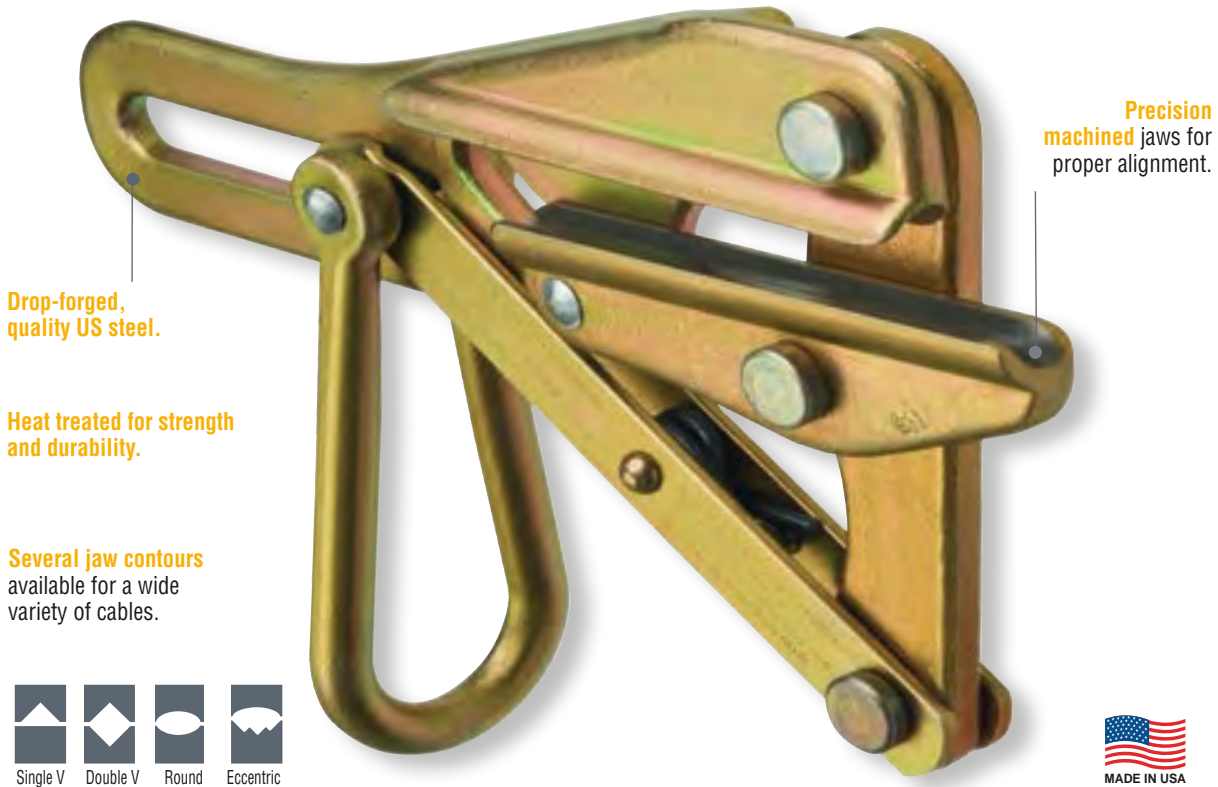

Drop-forged, quality US steel.

Heat treated for strength and durability.

Several jaw contours available for a wide variety of cables.

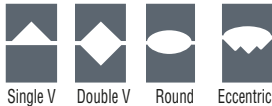

Single V Double V Round Eccentric



Reliability

Before leaving our manufacturing plant, each and every authentic Klein Grip is individually hand inspected and actuated for proper function. Grips are rigorously tested using the Magnflux method and pulled to rated load to ensure the highest quality and reliability for which Klein Tools is known.

Grip Recommendation

Klein Tools offers a service of recommending the proper grip for a particular application based on a sample of cable. This service is free of charge. All that we require is a minimum 3' (about 1 meter) length of cable.

Klein Tools has been manufacturing grips for over 135 years. All Klein Grips are manufactured, and tested in the USA.

If there is ever a question about the safe condition of any grip, please contact Klein Tools Customer Service at 847.821.5500 or 800.553.4676.



Recommended Care and Maintenance

Grip Cleaning, Lubricating and Inspecting

The following guidelines have been established to keep all grips in good working condition.

Cleaning



◀ **Step 1.** Use the Klein Grip Cleaning Wire Brush Set (Cat. No. 25450) or emery cloth to clean the surfaces of grip jaws (photo #1).



▲ **Step 2.** Spray degreaser on the grip jaws, all joints and moving parts (photo #2).



◀ **Step 3.** Use the Klein Grip Cleaning Wire Brush to remove dirt and debris from the grip jaws (photo #3).



▶ **Step 4.** Wipe grips dry with soft cloth. Repeat all cleaning steps as necessary until grip is completely clean (photo #4).

Lubricating

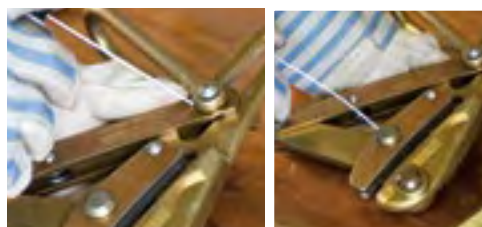

◀ **Step 5.** Apply lubricant to all joints and moving parts. Do NOT lubricate gripping surfaces of jaws (photos left #5).

▶ **Step 6.** Carefully inspect jaw condition, proper alignment of jaws and all parts, and possible distortion caused by exceeding safe-load specifications. Grips should operate smoothly. Spring-loaded grips should lock open with loop handle in "Down" position and should close automatically with loop handle "Up." The Klein Parallel Jaw Grip may be tested by opening and closing the jaws by hand, exercising proper caution. All parts and rivets should be checked for distortion (illustration #6).

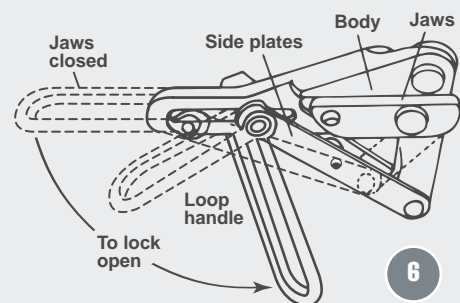

Never repair any grip. Grips that are bent, misaligned, or otherwise distorted should be discarded and replaced.

If there is ever a question about the safe condition of any grip, please contact Klein Tools Customer Service directly at **847-821-5500** or **800-553-4676**.

Note: Conductors may have a die-grease coating which can deposit on grip jaws. New conductors should be wiped clean before grip application. Grip jaws should be wiped clean of all grease before use.



Types of Wire Pulling Grips

Klein Chicago[®], Parallel Jaw and Haven's[®] Grips are widely used in the power, communications, and general construction fields to pull wire and cable. The grips maintain temporary tension until the wire or cable can be permanently terminated.

Klein Chicago[®] Grips

Authentic Chicago Grips are designed for use on aluminum, copper, weatherproof coated wire, PVC covered conductors and messenger and guy strand.

- Locking loop handles allow the jaws to be held in an open position for easy placement on wire or cable.
- Available in Round, Double V and Single V jaw contours.



1656-30

Parallel Jaw Grips

Lightweight compact parallel jaw grips pull an exceptionally wide range of cable types and sizes.

- Latch helps maintain cable position.
- Large-diameter eye accommodates large hooks on hoists, winches and tackle blocks.
- Available in Round and Double V jaw contours.



KT4500

Haven's[®] Grips

Haven's Grips are designed for use when a light, compact grip is desired where conductor deformation is not a factor.

- Knurled eccentric jaw applies gripping pressure to 1/4" of cable area.
- Some models include a swing latch that holds cable securely in jaw.
- Recommended for messenger and guy strand and wire rope.
- 1625 Series can be used for wire rope.



1625-20

Hot-line Latch

The hot-line latch is designed for placing a grip on cable with a hot-line stick. The three notches in the hot-line latch adjust the balance of the grip to better match the direction of the cable sag.

- When stick is removed, latch closes automatically to guard against grip accidentally disengaging from wire.
- Standard hot-line grips are not supplied with springs or lock-open features.

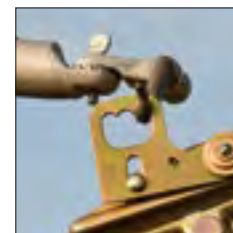

All dimensions are in inches and (millimeters) unless otherwise specified.

▲WARNING: Grips are to be used for temporary installation, not for permanent anchorage.







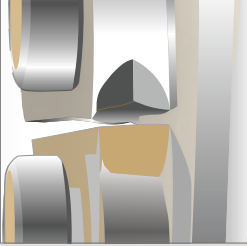

▲WARNING: When used on/or near energized lines, ground, insulate, or isolate grip before pulling.

▲WARNING: Do not exceed rated capacity.

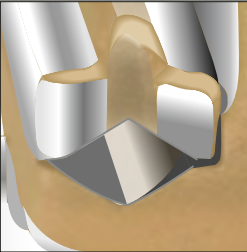
▲WARNING: Always match proper size and type of grip to application.

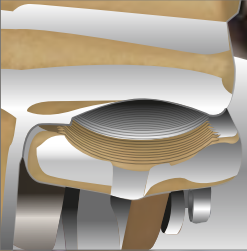
▲WARNING: Before each use, clean jaw area and inspect grip for proper operation to avoid slippage.

Types of Jaw Contours

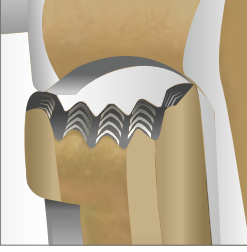
 Single V		Recommended for:			
		Steel Strand Cat. No.			
 <ul style="list-style-type: none"> Simple three-point contact jaws. Designed for use on small diameter bare wire and cable (solid and stranded). 	1613-30	-			
 Double V		Recommended for:			
		Steel Strand Cat. No.	Wide Range of Cables Cat. No.		
 <ul style="list-style-type: none"> Four-point contact provides greater gripping pressure and assures proper alignment of wire and cable within the jaws. Designed for high strength messenger and guy strand and extra high-strength cables and conductors, as well as a wide range of cables. 	1613-40 and 1613-40H, 1628-16 1628-16AT (Bell System) 1628-17, 1628-18, 1684-5 1684-5AT (Bell System) 1684-5H, 1692-5 1692-5AT (Bell System) 1684-74 and S1684-74H (EHS Cable) 1684-5F	1671-10 1672-10 1686-10 1686-20	-		
 Round		Recommended for:			
		ACSR and AAC Cat. No.	Weatherproof and PVC Covered Copper Cat. No.	Steel Strand Cat. No.	Wide Range of Cables Cat. No.
 <ul style="list-style-type: none"> Round jaws provide maximum contact and gripping power to minimize conductor deformation. (Smooth and knurled styles). Recommended for use on bare aluminum, ACSR, AAC and copper conductors as well as a wide range of cables. 	1628-16P SERIES 1628-30 SERIES 1628-40 SERIES 1628-50 SERIES 1656-20 and 1656-20H 1656-30 and 1656-30H 1656-40 and 1656-40H 1656-50 and 1656-50H 1656-60 and 1656-60H	 1611-20 1611-30 1611-40 1611-50 Notched Jaw  1659-20 1659-30 1659-40 1659-50 Serpentine Jaw	 1659-5AT Serpentine Jaw	1685-20 1685-31	
 Eccentric		Recommended for:			
		Steel Strand Cat. No.			
 <ul style="list-style-type: none"> Eccentric jaw applies gripping pressure to 1/4" of cable area. Recommended for use when conductor deformation is not an issue. Available only on the Haven's® Grips. 	1604-10 1604-20 1604-20L 1625-20 (For Wire Rope) 1625-20 1 (For Wire Rope) 1625-20 7/8 (For Wire Rope)	-			

Selecting the Proper Grip

Three basic factors are needed in order to determine the proper grip for each specific application:

1. Type of wire or cable (ACSR, ACSS, AAC, Copper, Steel Strand).
2. AWG or MCM (diameter) of wire or cable.
3. Maximum safe load required.

Klein Grips are organized according to these three factors to make it easy for you to choose the proper grip.



ACSR (Aluminum Conductor Steel Reinforced)

For Cable Diameter

4 AWG - 636 MCM

.250" - .953" (6.35 mm - 24.21 mm)

MAXIMUM SAFE LOAD

See facing page for grip details.

AWG or MCM Cable Size	Diameter inches (mm)	No. of Alum. & Steel Strands	Code Word	MAXIMUM SAFE LOAD			
				A 4,500 lbs (2041 kg)	B 8,000 lbs (3629 kg)	C 15,000 lbs (6803 kg)	D 20,000 lbs (9072 kg)
				Cat. No.	Cat. No.	Cat. No.	Cat. No.
4	.250" (6.35 mm)	6 x 1	Swan	1656-20, 1656-20H & S1656-20H			
4	.257" (6.53 mm)	7 x 1	Swanate	1656-20, 1656-20H & S1656-20H			
2	.316" (8.03 mm)	6 x 1	Sparrow	1656-20, 1656-20H, S1656-20H, 1656-30, 1656-30H & S1656-30H		1628-16PE*	
2	.325" (8.26 mm)	7 x 1	Sparate	1656-20, 1656-20H, S1656-20H, 1656-30, 1656-30H & S1656-30H		1628-16PE*	
1	.354" (9.02 mm)	6 x 1	Robin	1656-20, 1656-20H, S1656-20H, 1656-30, 1656-30H & S1656-30H		1628-16PF*	
1/0	.398" (10.11 mm)	6 x 1	Raven	1656-20, 1656-20H, S1656-20H, 1656-30, 1656-30H & S1656-30H		1628-16PG*	
2/0	.447" (11.35 mm)	6 x 1	Quail	1656-30, 1656-30H & S1656-30H		1628-16PG*	
3/0	.502" (12.75 mm)	6 x 1	Pigeon	1656-30, 1656-30H & S1656-30H		1628-16PH*	
4/0	.563" (14.30 mm)	6 x 1	Penguin		1656-40, 1656-40H & S1656-40H	1628-16PI*	
266.8 MCM	.609" (15.47 mm)	18 x 1	Waxwing		1656-40, 1656-40H & S1656-40H	1628-16PJ*	
266.8 MCM	.642" (16.31 mm)	26 x 7	Partridge		1656-40, 1656-40H & S1656-40H	1628-16PK*	
300 MCM	.680" (17.27 mm)	26 x 7	Ostrich		1656-40, 1656-40H & S1656-40H	1628-16PK*	
336.4 MCM	.684" (17.37 mm)	18 x 1	Merlin		1656-40, 1656-40H & S1656-40H	1628-16PK*	
336.4 MCM	.720" (18.31 mm)	26 x 7	Linnet		1656-40, 1656-40H & S1656-40H	1628-16PL*	
336.4 MCM	.741" (18.82 mm)	30 x 7	Oriole			1628-16PL*	
397.5 MCM	.743" (18.87 mm)	18 x 1	Chickadee		1656-50, 1656-50H & S1656-50H	1628-16PL*	
397.5 MCM	.772" (19.61 mm)	24 x 7	Brant		1656-50, 1656-50H & S1656-50H	1628-16PM*	
397.5 MCM	.783" (19.89 mm)	26 x 7	Ibis		1656-50, 1656-50H & S1656-50H	1628-16PM*	
397.5 MCM	.806" (20.47 mm)	30 x 7	Lark		1656-50, 1656-50H & S1656-50H	1628-16PM*	
477 MCM	.814" (20.68 mm)	18 x 1	Pelican		1656-50, 1656-50H & S1656-50H	1628-16PM*	
477 MCM	.846" (21.49 mm)	24 x 7	Flicker		1656-50, 1656-50H & S1656-50H	1628-16PM*	1628-30N*
477 MCM	.858" (21.79 mm)	26 x 7	Hawk		1656-50, 1656-50H & S1656-50H	1628-16PM*	1628-30N*
556.5 MCM	.879" (22.33 mm)	18 x 1	Osprey		1656-60, 1656-60H & S1656-60H	1628-16PN*	1628-30N*
477 MCM	.883" (22.43 mm)	30 x 7	Hen		1656-60, 1656-60H & S1656-60H	1628-16PN*	1628-30N*
556.5 MCM	.914" (23.22 mm)	24 x 7	Parakeet		1656-60, 1656-60H and S1656-60H		1628-300*
556.5 MCM	.927" (23.55 mm)	26 x 7	Dove		1656-60, 1656-60H & S1656-60H		1628-300*
636 MCM	.940" (23.88 mm)	18 x 1	Kingbird		1656-60, 1656-60H & S1656-60H		1628-300*
556.5 MCM	.953" (24.21 mm)	30 x 7	Eagle		1656-60, 1656-60H & S1656-60H		1628-300*
605 MCM	.953" (24.21 mm)	24 x 7	Peacock		1656-60, 1656-60H & S1656-60H		1628-300*

"S" is for spring. "H" is for hot latch.

*Special order only. Please allow 30 days for delivery. These are not returnable.

All dimensions are in inches and (millimeters) unless otherwise specified.

WARNING: Grips are to be used for temporary installation, not for permanent anchorage.

WARNING: When used on/or near energized lines, ground, insulate, or isolate grip before pulling.

WARNING: Do not exceed rated capacity.

WARNING: Always match proper size and type of grip to application.

WARNING: Before each use, clean jaw area and inspect grip for proper operation to avoid slippage.



ACSR (Aluminum Conductor Steel Reinforced)

Chicago® Grip – 1656 Series

- Round, smooth inside jaw contour on this series of grips is ideal for bare ACSR.
- Smooth jawed grips with maximum contact are less likely to cause cable deformation.



1656-30

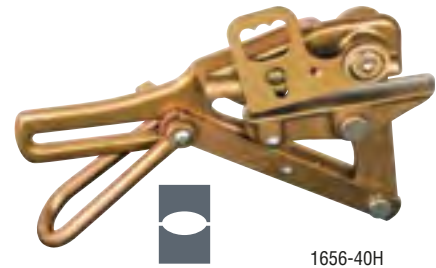

1656-40H

A 4,500 lbs. (2,041 kg) Maximum Safe Load

Cat. No.	Hot Latch Model No.	Hot Latch/Spring Model No.	Min. to Max. Cable AWG	Min. to Max. Cable Diameter inches (mm)	Jaw Length	Approx. Weight Each
1656-20	1656-20H	S1656-20H	4 - 1/0	.250" - .398" (6.35 mm - 10.11 mm)	4" (102 mm)	3 lbs. (1.36 kg)
1656-30	1656-30H	S1656-30H	2 - 3/0	.325" - .502" (8.25 mm - 12.75 mm)	4-3/4" (121 mm)	3.75 lbs. (1.70 kg)

B 8,000 lbs. (3,629 kg) Maximum Safe Load

Cat. No.	Hot Latch Model No.	Hot Latch/Spring Model No.	Min. to Max. Cable AWG or MCM	Min. to Max. Cable Diameter inches (mm)	Jaw Length	Approx. Weight Each
1656-40	1656-40H	S1656-40H	4/0 - 336.4 MCM	.563" - .720" (14.30 mm - 18.29 mm)	5-1/2" (140 mm)	8.30 lbs. (3.76 kg)
1656-50	1656-50H	S1656-50H	397.5 MCM - 477 MCM	.743" - .858" (18.82 mm - 21.79 mm)	5-1/2" (140 mm)	8.30 lbs. (3.76 kg)
1656-60	1656-60H	S1656-60H	477 MCM - 636 MCM	.879" - .953" (22.33 mm - 24.21 mm)	5-1/2" (140 mm)	8.20 lbs (3.71 kg)

Chicago® Grip – 1628-16P and 1628-30 Series

- Round jaws are shaped to provide maximum contact with the cable, virtually eliminating cable deformation.
- Designed for large-diameter ACSR cables.

C 15,000 lbs. (6,803 kg) Maximum Safe Load

Cat. No.	Min. to Max. Cable AWG or MCM	Min. to Max. Cable Diameter inches (mm)	Jaw Length	Approx. Weight Each
1628-16PE*	2	.316" - .325" (8.03 mm - 8.25 mm)	7-1/4" (184 mm)	17 lbs. (7.73 kg)
1628-16PF*	1	.354" (8.99 mm)	7-1/4" (184 mm)	17 lbs. (7.73 kg)
1628-16PG*	1/0 - 2/0	.398" - .447" (10.11 mm - 11.35 mm)	7-1/4" (184 mm)	17 lbs. (7.73 kg)
1628-16PH*‡	3/0	.502" (12.75 mm)	7-1/4" (184 mm)	17 lbs. (7.73 kg)
1628-16PI*	4/0	.563" (14.30 mm)	7-1/4" (184 mm)	17 lbs. (7.73 kg)
1628-16PJ*	266.8 MCM	.609" (15.47 mm)	7-1/4" (184 mm)	17 lbs. (7.73 kg)
1628-16PK*	266.8 MCM - 336.4 MCM	.642" - .684" (16.31 mm - 17.37 mm)	7-1/4" (184 mm)	17 lbs. (7.73 kg)
1628-16PL*	336.4 MCM - 397.5 MCM	.720" - .743" (18.29 mm - 18.87 mm)	7-1/4" (184 mm)	17 lbs. (7.73 kg)
1628-16PM*	397.5 MCM - 477 MCM	.772" - .814" (19.61 mm - 20.68 mm)	7-1/4" (184 mm)	17 lbs. (7.73 kg)
1628-16PN*	477 MCM - 556.5 MCM	.846" - .883" (21.49 mm - 22.43 mm)	7-1/4" (184 mm)	17 lbs. (7.73 kg)



1628-16P

‡ The "H" suffix does not mean Hot Latch, this is only for Cat. No. 1628-16PH



1628-30

D 20,000 lbs. (9,072 kg) Maximum Safe Load

Cat. No.	Min. to Max. Cable MCM	Min. to Max. Cable Diameter inches (mm)	Jaw Length	Approx. Weight Each
1628-30N**	477 MCM - 556.5 MCM	.846" - .883" (21.49 mm - 22.43 mm)	10-3/4" (273 mm)	27 lbs. (12.27 kg)
1628-300**	556.5 MCM - 636 MCM	.914" - .953" (23.22 mm - 24.21 mm)	10-3/4" (273 mm)	27 lbs. (12.27 kg)

*These grips are special order only. Please allow 30 days for delivery. These are not returnable.

**Maximum safe stringing tension 12,500 lbs to minimize cable deformation.

All dimensions are in inches and (millimeters) unless otherwise specified.

⚠WARNING: Grips are to be used for temporary installation, not for permanent anchorage.

⚠WARNING: When used on/or near energized lines, ground, insulate, or isolate grip before pulling.

⚠WARNING: Do not exceed rated capacity.

⚠WARNING: Always match proper size and type of grip to application.

⚠WARNING: Before each use, clean jaw area and inspect grip for proper operation to avoid slippage.



ACSR (Aluminum Conductor Steel Reinforced)

See facing page
for grip details.

For Cable Diameter

605 - 2515 MCM

.966" - 1.88" (24.54 mm - 47.75 mm)

MCM Cable Size	Diameter inches (mm)	No. of Alum. & Steel Strands	Code Word	C			D			E		
				20,000 lbs (9,072 kg)			25,000 lbs (11,340 kg)			25,000 lbs. with bolt on jaw (11,340 kg)		
				Cat. No.		Cat. No.		Cat. No.		Cat. No.		Cat. No.
605 MCM	.966" (24.54 mm)	26 x 7	Squab	1628-30P*				1628-50P*				
636 MCM	.977" (24.82 mm)	24 x 7	Rook	1628-30P*				1628-50P*				
636 MCM	.991" (25.15 mm)	26 x 7	Grosbeak	1628-30P*				1628-50P*				
605 MCM	.994" (25.25 mm)	30 x 19	Teal	1628-30P*				1628-50P*				
605 MCM	.994" (25.25 mm)	30 x 7	Wood Duck	1628-30P*				1628-50P*				
666.6 MCM	1.00" (25.40 mm)	24 x 7	Flamingo	1628-30P*				1628-50P*				
666.6 MCM	1.014" (25.76 mm)	26 x 7	Gannet	1628-30P*				1628-50P*				
636 MCM	1.019" (25.88 mm)	30 x 19	Egret	1628-30R*				1628-50R*				
636 MCM	1.019" (25.88 mm)	30 x 7	Scoter	1628-30R*				1628-50R*				
795 MCM	1.040" (26.41 mm)	36 x 1	Coot	1628-30R*				1628-50R*				
715.5 MCM	1.051" (26.70 mm)	26 x 7	Starling	1628-30R*				1628-50R*				
795 MCM	1.063" (27.00 mm)	45 x 7	Tern	1628-30R*				1628-50R*				
715.5 MCM	1.081" (27.46 mm)	30 x 19	Redwing	1628-30S*				1628-50S*				
795 MCM	1.092" (27.76 mm)	54 x 7	Condor	1628-30S*				1628-50S*				
795 MCM	1.092" (27.74 mm)	24 x 7	Cuckoo	1628-30S*				1628-50S*				
795 MCM	1.107" (28.14 mm)	26 x 7	Drake	1628-30S*				1628-50S*				
900 MCM	1.131" (28.73 mm)	45 x 7	Ruddy	1628-30S*				1628-50S*				
795 MCM	1.140" (28.96 mm)	30 x 19	Mallard	1628-30S*				1628-50S*				
900 MCM	1.162" (29.51 mm)	54 x 7	Canary	1628-30T*				1628-50T*				
954 MCM	1.165" (29.59 mm)	20 x 7	Corncrake	1628-30T*				1628-50T*				
954 MCM	1.165" (29.59 mm)	45 x 7	Rail	1628-30T*				1628-50T*				
954 MCM	1.175" (29.85 mm)	48 x 7	Towhee	1628-30T*				1628-50T*				
954 MCM	1.196" (30.38 mm)	54 x 7	Cardinal	1628-30T*				1628-50T*				
954 MCM	1.196" (30.38 mm)	24 x 7	Redbird	1628-30T*				1628-50T*				
1033.5 MCM	1.212" (30.81 mm)	45 x 7	Ortolan	1628-30U*		1628-40U*		1628-50U*				
1033.5 MCM	1.245" (31.65 mm)	54 x 7	Curlew	1628-30U*		1628-40U*		1628-50U*				
1113 MCM	1.258" (31.95 mm)	45 x 7	Bluejay	1628-30U*		1628-40U*		1628-50U*				
1113 MCM	1.292" (32.84 mm)	54 x 19	Finch			1628-40W*		1628-50W*				
1192.5 MCM	1.302" (33.07 mm)	45 x 7	Bunting			1628-40W*		1628-50W*				
1272 MCM	1.317" (33.45 mm)	36 x 1	Skylark			1628-40W*		1628-50W*				
1192.5 MCM	1.337" (33.99 mm)	54 x 19	Grackle			1628-40X*		1628-50X*				
1272 MCM	1.345" (34.16 mm)	45 x 7	Bittern			1628-40X*		1628-50X*				
1272 MCM	1.381" (35.10 mm)	54 x 19	Pheasant			1628-40X*		1628-50X*				
1351.5 MCM	1.386" (35.20 mm)	45 x 7	Dipper			1628-40X*		1628-50X*				
1351.5 MCM	1.424" (36.17 mm)	54 x 19	Martin			1628-40Y*		1628-50Y*				
1431 MCM	1.427" (36.25 mm)	45 x 7	Bobolink			1628-40Y*		1628-50Y*				
1431 MCM	1.465" (37.21 mm)	54 x 19	Plover			1628-40Z*		1628-50Z*				
1590 MCM	1.504" (38.15 mm)	45 x 7	Lapwing			1628-40Z*		1628-50Z*				
1590 MCM	1.544" (39.24 mm)	54 x 19	Falcon			1628-40A*		1628-50A*				
1780 MCM	1.602" (40.69 mm)	84 x 19	Chukar					1628-50B*				
2034.5 MCM	1.681" (42.70 mm)	72 x 7	Mockingbird					1628-50C*				
2167 MCM	1.735" (44.12 mm)	72 x 7	Kiwi					1628-50D*				
2156 MCM	1.762" (44.75 mm)	84 x 19	Bluebird					1628-50D*				
2312 MCM	1.802" (45.77 mm)	76 x 19	Thrasher					1628-50E*				
2515 MCM	1.88" (47.75 mm)	76 x 19	Jorea					1628-50F*				

*Special order only. Please allow 30 days for delivery. These are not returnable.

All dimensions are in inches and (millimeters) unless otherwise specified.

WARNING: Grips are to be used for temporary installation, not for permanent anchorage.

WARNING: When used on/or near energized lines, ground, insulate, or isolate grip before pulling.

WARNING: Do not exceed rated capacity.

WARNING: Always match proper size and type of grip to application.

WARNING: Before each use, clean jaw area and inspect grip for proper operation to avoid slippage.



ACSR (Aluminum Conductor Steel Reinforced)

Chicago® Grip – 1628 Series

- Round jaws are shaped to provide maximum contact with the cable, virtually eliminating cable deformation.

C 20,000 lbs. (9,072 kg) Maximum Safe Load

Cat. No.	Min. to Max. Cable MCM	Min. to Max. Cable Dia. in. (mm)	Jaw Length	Approx. Wt. Each
1628-30P*	605 MCM - 666.6 MCM	.966" - 1.014" (24.54 mm - 25.76 mm)	10-3/4" (273 mm)	27 lbs. (12.27 kg)
1628-30R*	636 MCM - 795 MCM	1.019" - 1.063" (25.88 mm - 27.00 mm)	10-3/4" (273 mm)	27 lbs. (12.27 kg)
1628-30S*	715.5 MCM - 900 MCM	1.081" - 1.140" (27.46 mm - 28.96 mm)	10-3/4" (273 mm)	27 lbs. (12.27 kg)
1628-30T*	900 MCM - 954 MCM	1.162" - 1.196" (29.51 mm - 30.38 mm)	10-3/4" (273 mm)	27 lbs. (12.27 kg)
1628-30U*	1033.5 MCM - 1113 MCM	1.212" - 1.258" (30.75 mm - 31.95 mm)	10-3/4" (273 mm)	27 lbs. (12.27 kg)



1628-30

D 25,000 lbs. (11,340 kg) Maximum Safe Load

Cat. No.	Min. to Max. Cable MCM	Min. to Max. Cable Dia. in. (mm)	Jaw Length	Approx. Wt. Each
1628-40U*	1033.5 MCM - 1113 MCM	1.212" - 1.258" (30.75 mm - 31.95 mm)	10-3/4" (273 mm)	34 lbs. (15.45 kg)
1628-40W*	1113 MCM - 1272 MCM	1.292" - 1.317" (32.82 mm - 33.45 mm)	10-3/4" (273 mm)	34 lbs. (15.45 kg)
1628-40X*	1192.5 MCM - 1351.5 MCM	1.337" - 1.386" (33.96 mm - 35.20 mm)	10-3/4" (273 mm)	34 lbs. (15.45 kg)
1628-40Y*	1351.5 MCM - 1431 MCM	1.424" - 1.427" (36.17 mm - 36.25 mm)	10-3/4" (273 mm)	34 lbs. (15.45 kg)
1628-40Z*	1431 MCM - 1590 MCM	1.465" - 1.504" (37.21 mm - 38.20 mm)	10-3/4" (273 mm)	34 lbs. (15.45 kg)
1628-40A*	1590 MCM	1.544" (39.22 mm)	10-3/4" (273 mm)	34 lbs. (15.45 kg)



1628-40

*These grips are special order only. Please allow 30 days for delivery. These are not returnable.

Chicago® Grip – Dual Conductor

- Designed specifically for VR2® (vibration-resistant) and TransPowr® T-2® dual conductor twisted pair cables.
- Machined upper and lower jaws eliminate scoring or damage to second conductor.
- Round jaws shaped to provide maximum contact with circumference of cable and prevent cable deformation.
- Supplied with spring and locking loop handles, allows jaws to be held in open position for easier placement on cable.

D 25,000 lbs. (11,340 kg) Maximum Safe Load

Cat. No.	Min. to Max. Cable MCM	Min. to Max. Cable Dia. in. (mm)	Jaw Length	Approx. Wt. Each
1628-40VRU	1113 MCM - 1192.5 MCM	1.212" - 1.258" (30.75 mm - 31.95 mm)	10-3/4" (273 mm)	34 lbs. (15.45 kg)

Currently available in U size. Made to order sizes also available. Please call Klein Tools for expected delivery dates.



1628-40VRU

*These grips are special order only. Please allow 30 days for delivery. These are not returnable.

VR2 is a registered trademark of Southwire Company. TransPowr and T-2 are registered trademarks of General Cable Technologies Corporation.



ACSS (Aluminum Conductor Steel Supported)

Chicago® Grip – 1628-50 Series

- Round jaws shaped to provide maximum contact with circumference of cable, less likely to cause cable deformation.
- Supplied with spring and locking loop handles, allowing jaws to be held in open position for easier placement on cable.
- Removable bolt on floating jaw, secured by a slotted nut and cotter pin. Jaw provides increased cable coverage.



1628-50

E **25,000 lbs. (11,340 kg)**
Maximum Safe Load with bolt on jaw

For Cable Diameter

605 - 2515 MCM

.966" - 1.88" (24.54 mm - 47.75 mm)

				E					E
				25,000 lbs. (11,340 kg) with bolt on jaw					25,000 lbs. (11,340 kg) with bolt on jaw
MCM Cable Size	Diameter inches (mm)	No. of Alum. & Steel Strands	Code Word	Cat. No.	MCM Cable Size	Diameter inches (mm)	No. of Alum. & Steel Strands	Code Word	Cat. No.
605 MCM	.966" (24.54 mm)	26 x 7	Squab/ACSS	1628-50P*	1033.5 MCM	1.212" (30.81 mm)	45 x 7	Ortolan/ACSS	1628-50U*
636 MCM	.977" (24.82 mm)	24 x 7	Rook/ACSS	1628-50P*	1033.5 MCM	1.245" (31.65 mm)	54 x 7	Curlew/ACSS	1628-50U*
636 MCM	.991" (25.15 mm)	26 x 7	Grosbeak/ACSS	1628-50P*	1113 MCM	1.258" (31.95 mm)	45 x 7	Bluejay/ACSS	1628-50U*
605 MCM	.994" (25.25 mm)	30 x 7	Wood Duck/ACSS	1628-50P*	1113 MCM	1.292" (32.84 mm)	54 x 19	Finch/ACSS	1628-50W*
605 MCM	.994" (25.25 mm)	30 x 19	Teal/ACSS	1628-50P*	1192.5 MCM	1.302" (33.07 mm)	45 x 7	Bunting/ACSS	1628-50W*
666.6 MCM	1.00" (25.40 mm)	24 x 7	Flamingo/ACSS	1628-50P*	1192.5 MCM	1.337" (33.99 mm)	54 x 19	Grackle/ACSS	1628-50X*
666.6 MCM	1.014" (25.76 mm)	26 x 7	Gannet/ACSS	1628-50P*	1272 MCM	1.345" (34.16 mm)	45 x 7	Bittern/ACSS	1628-50X*
636 MCM	1.019" (25.88 mm)	30 x 19	Egret/ACSS	1628-50R*	1272 MCM	1.381" (35.10 mm)	54 x 19	Pheasant/ACSS	1628-50X*
636 MCM	1.019" (25.88 mm)	30 x 7	Scoter/ACSS	1628-50R*	1351.5 MCM	1.386" (35.20 mm)	45 x 7	Dipper/ACSS	1628-50X*
715.5 MCM	1.051" (26.70 mm)	26 x 7	Starling/ACSS	1628-50R*	1351.5 MCM	1.424" (36.17 mm)	54 x 19	Martin/ACSS	1628-50Y*
795 MCM	1.063" (27.00 mm)	45 x 7	Tern/ACSS	1628-50R*	1431 MCM	1.427" (36.25 mm)	45 x 7	Bobolink/ACSS	1628-50Y*
715.5 MCM	1.081" (27.46 mm)	30 x 19	Redwing/ACSS	1628-50S*	1431 MCM	1.465" (37.21 mm)	54 x 19	Plover/ACSS	1628-50Z*
795 MCM	1.092" (27.74 mm)	24 x 7	Cuckoo/ACSS	1628-50S*	1590 MCM	1.504" (38.15 mm)	45 x 7	Lapwing/ACSS	1628-50Z*
795 MCM	1.092" (27.76 mm)	54 x 7	Condor/ACSS	1628-50S*	1590 MCM	1.544" (39.24 mm)	54 x 19	Falcon/ACSS	1628-50A*
795 MCM	1.107" (28.14 mm)	26 x 7	Drake/ACSS	1628-50S*	1780 MCM	1.602" (40.69 mm)	84 x 19	Chukar/ACSS	1628-50B*
900 MCM	1.131" (28.73 mm)	45 x 7	Ruddy/ACSS	1628-50S*	2034.5 MCM	1.681" (42.70 mm)	72 x 7	Mockingbird/ACSS	1628-50C*
795 MCM	1.140" (28.96 mm)	30 x 19	Mallard/ACSS	1628-50S*	2167 MCM	1.735" (44.12 mm)	72 x 7	Kiwii/ACSS	1628-50D*
900 MCM	1.162" (29.51 mm)	54 x 7	Canary/ACSS	1628-50T*	2156 MCM	1.762" (44.75 mm)	84 x 19	Bluebird/ACSS	1628-50D*
954 MCM	1.165" (29.59 mm)	20 x 7	Corncrake/ACSS	1628-50T*	2312 MCM	1.802" (45.77 mm)	76 x 19	Thrasher/ACSS	1628-50E*
954 MCM	1.165" (29.59 mm)	45 x 7	Rail/ACSS	1628-50T*	2515 MCM	1.88" (47.75 mm)	76 x 19	Joreau/ACSS	1628-50F*
954 MCM	1.175" (29.85 mm)	48 x 7	Towhee/ACSS	1628-50T*					
954 MCM	1.196" (30.38 mm)	54 x 7	Cardinal/ACSS	1628-50T*					
954 MCM	1.196" (30.38 mm)	24 x 7	Redbird/ACSS	1628-50T*					

*Klein Tools recommends using the 1628-50 series grips for ACSS cable. Special order only. **Application must be confirmed prior to ordering.** Please allow 30 days for delivery. Jaw must be removed to insert cable.

E **25,000 lbs. (11,340 kg) Maximum Safe Load with bolt on jaw**

Cat. No.	Min. to Max. Cable MCM	Min. to Max. Cable Dia. in. (mm)	Jaw Length	Approx. Wt. Each
1628-50P*	605 MCM - 666.6 MCM	.966" - 1.014" (24.54 mm - 25.76 mm)	10-3/4" (273 mm)	34 lbs. (15.45 kg)
1628-50R*	636 MCM - 795 MCM	1.019" - 1.063" (25.88 mm - 27.00 mm)	10-3/4" (273 mm)	34 lbs. (15.45 kg)
1628-50S*	715.5 MCM - 900 MCM	1.081" - 1.140" (27.46 mm - 28.96 mm)	10-3/4" (273 mm)	34 lbs. (15.45 kg)
1628-50T*	900 MCM - 954 MCM	1.162" - 1.196" (29.51 mm - 30.38 mm)	10-3/4" (273 mm)	34 lbs. (15.45 kg)
1628-50U*	1033.5 MCM - 1113 MCM	1.212" - 1.258" (30.75 mm - 31.95 mm)	10-3/4" (273 mm)	34 lbs. (15.45 kg)
1628-50W*	1113 MCM - 1272 MCM	1.292" - 1.317" (32.82 mm - 33.45 mm)	10-3/4" (273 mm)	34 lbs. (15.45 kg)
1628-50X*	1192.5 MCM - 1351.5 MCM	1.337" - 1.386" (33.96 mm - 35.20 mm)	10-3/4" (273 mm)	34 lbs. (15.45 kg)
1628-50Y*	1351.5 MCM - 1431 MCM	1.424" - 1.427" (36.17 mm - 36.25 mm)	10-3/4" (273 mm)	34 lbs. (15.45 kg)
1628-50Z*	1431 MCM - 1590 MCM	1.465" - 1.504" (37.21 mm - 38.20 mm)	10-3/4" (273 mm)	34 lbs. (15.45 kg)
1628-50A*	1590 MCM	1.544" (39.22 mm)	10-3/4" (273 mm)	34 lbs. (15.45 kg)
1628-50B*	1780 MCM	1.602" (40.69 mm)	10-3/4" (273 mm)	34 lbs. (15.45 kg)
1628-50C*	2034.5 MCM	1.681" (42.70 mm)	10-3/4" (273 mm)	34 lbs. (15.45 kg)
1628-50D*	2156 MCM - 2167 MCM	1.735" - 1.762" (44.12 mm - 44.75 mm)	10-3/4" (273 mm)	34 lbs. (15.45 kg)
1628-50E*	2312 MCM	1.802" (45.77 mm)	10-3/4" (273 mm)	34 lbs. (15.45 kg)
1628-50F*	2515 MCM	1.88" (47.75 mm)	10-3/4" (273 mm)	34 lbs. (15.45 kg)



- Removable bolt on floating jaw, secured by a slotted nut and cotter pin. Jaw provides increased cable coverage.

Note: Jaw must be removed to insert cable.

VR2 is a registered trademark of Southwire Company. TransPowr and T-2 are registered trademarks of General Cable Technologies Corporation.



ACSS/TW (Aluminum Conductor Steel Supported/Trapezoidal Wire)

For Cable Diameter

795 - 2627.3 MCM

.960" - 1.762" (24.38 mm - 44.75 mm)

MCM Cable Size	Diameter inches (mm)	No. of Alum. & Steel Strands	Code Word	D 25,000 lbs. (11,340 kg)	E 25,000 lbs. (11,340 kg) with bolt on jaw
					Cat. No
397.5 MCM	.766"- .828" (19.46 mm - 21.03 mm)	18 x 7	Brant/Iis/Lark	1628-400*	1628-500*
556.5 MCM - 600 MCM	.891"- .953" (22.63 mm - 24.20 mm)	18 x 7	Maumee/ACSS/TW	1628-40M*	1628-50M*
795 MCM	.960" (24.38 mm)	17 x 7	Tern/ACSS/TW		1628-50P*
768.2 MCM	.977" (24.82 mm)	20 x 7	Maumee/ACSS/TW		1628-50P*
795 MCM	.980" (24.89 mm)	18 x 7	Puffin/ACSS/TW		1628-50P*
795 MCM	.993" (25.22 mm)	20 x 7	Condor/ACSS/TW		1628-50P*
762.8 MCM	.990" (25.15 mm)	20 x 7	Wabash/ACSS/TW		1628-50P*
795 MCM	1.010" (25.65 mm)	20 x 7	Drake/ACSS/TW		1628-50P*
954 MCM	1.049" (26.64 mm)	30 x 7	Phoenix/ACSS/TW		1628-50R*
957.2 MCM	1.060" (26.92 mm)	32 x 7	Kettle/ACSS/TW		1628-50R*
954 MCM	1.061" (26.94 mm)	32 x 7	Rail/ACSS/TW		1628-50R*
946.7 MCM	1.077" (27.36 mm)	35 x 7	Fraser/ACSS/TW		1628-50R*
954 MCM	1.084" (27.53 mm)	20 x 7	Cardinal/ACSS/TW		1628-50S*
1033.5 MCM	1.089" (27.66 mm)	30 x 7	Snowbird/ACSS/TW		1628-50S*
966.2 MCM	1.092" (27.73 mm)	21 x 7	Columbia/ACSS/TW		1628-50S*
959.6 MCM	1.108" (28.14 mm)	22 x 7	Suwannee/ACSS/TW		1628-50S*
1033.5 MCM	1.102" (27.99 mm)	32 x 7	Ortolan/ACSS/TW		1628-50S*
1033.5 MCM	1.129" (28.68 mm)	21 x 7	Curlew/ACSS/TW		1628-50S*
1113 MCM	1.129" (28.68 mm)	30 x 7	Avocet/ACSS/TW		1628-50S*
1113 MCM	1.143" (29.03 mm)	33 x 7	Bluejay/ACSS/TW		1628-50T*
1168.1 MCM	1.155" (29.34 mm)	30 x 7	Cheyenne/ACSS/TW		1628-50T*
1158 MCM	1.165" (29.59 mm)	33 x 7	Genessee/ACSS/TW		1628-50T*
1192.5 MCM	1.167" (29.64 mm)	30 x 7	Oxbird/ACSS/TW		1628-50T*
1192.5 MCM	1.181" (29.99 mm)	33 x 7	Bunting/ACSS/TW		1628-50T*
1113 MCM	1.185" (30.10 mm)	38 x 19	Finch/ACSS/TW		1628-50T*
1158.4 MCM	1.196" (30.38 mm)	25 x 7	Hudson/ACSS/TW		1628-50T*
1272 MCM	1.203" (30.56 mm)	30 x 7	Scissortail/ACSS/TW		1628-50T*
1272 MCM	1.203" (30.56 mm)	30 x 7	Catawba/ACSS/TW		1628-50T*
1257.1 MCM	1.213" (30.81 mm)	35 x 7	Nelson/ACSS/TW		1628-50U*
1272 MCM	1.220" (30.99 mm)	35 x 7	Bittern/ACSS/TW		1628-50U*
1192.5 MCM	1.225" (31.12 mm)	38 x 19	Grackle/ACSS/TW		1628-50U*
1233.6 MCM	1.245" (31.62 mm)	38 x 19	Yukon/ACSS/TW		1628-50U*
1371.5 MCM	1.248" (31.70 mm)	30 x 7	Truckee/ACSS/TW		1628-50U*
1351.5 MCM	1.256" (31.90 mm)	35 x 7	Dipper/ACSS/TW		1628-50U*
1272 MCM	1.264" (32.11 mm)	39 x 19	Pheasant/ACSS/TW		1628-50U*
1359.7 MCM	1.269" (32.23 mm)	36 x 7	Mackenzie/ACSS/TW		1628-50W*
1431 MCM	1.291" (32.79 mm)	36 x 7	Bobolink/ACSS/TW		1628-50W*
1467.8 MCM	1.292" (32.82 mm)	33 x 7	St. Croix/ACSS/TW		1628-50W*
1334.6 MCM	1.293" (32.84 mm)	39 x 19	Thames/ACSS/TW		1628-50W*
1351.5 MCM	1.300" (33.02 mm)	39 x 19	Martin/ACSS/TW		1628-50W*
1455.3 MCM	1.302" (33.07 mm)	36 x 7	Miramichi/ACSS/TW		1628-50W*
1569 MCM	1.334" (33.88 mm)	33 x 7	Platte/ACSS/TW		1628-50X*
1431 MCM	1.337" (33.96 mm)	39 x 19	Plover/ACSS/TW		1628-50X*
1433.6 MCM	1.338" (33.99 mm)	39 x 19	Merrimack/ACSS/TW		1628-50X*
1557.4 MCM	1.345" (34.16 mm)	36 x 7	Potomac/ACSS/TW		1628-50X*
1590 MCM	1.358" (34.49 mm)	36 x 7	Lapwing/ACSS/TW		1628-50X*
1533.3 MCM	1.382" (35.10 mm)	39 x 19	Rio Grande/ACSS/TW		1628-50X*
1657.4 MCM	1.386" (35.20 mm)	36 x 7	Schuykill/ACSS/TW		1628-50X*
1590 MCM	1.408" (35.76 mm)	42 x 19	Falcon/ACSS/TW		1628-50Y*
1622 MCM	1.424" (36.17 mm)	39 x 19	Pecos/ACSS/TW		1628-50Y*
1758.6 MCM	1.427" (36.25 mm)	37 x 7	Pee Dee/ACSS/TW		1628-50Y*
1780 MCM	1.445" (36.70 mm)	37 x 19	Chukar/ACSS/TW		1628-50Y*
1730.6 MCM	1.465" (37.21 mm)	39 x 19	James/ACSS/TW		1628-50Z*
1949.6 MCM	1.504" (38.20 mm)	42 x 7	Athabaska/ACSS/TW		1628-50Z*
1926.9 MCM	1.545" (39.24 mm)	42 x 19	Cumberland/ACSS/TW		1628-50A*
2153.8 MCM	1.602" (40.69 mm)	64 x 19	Powder/ACSS/TW		1628-50B*
2156 MCM	1.608" (40.84 mm)	64 x 19	Bluebird/ACSS/TW		1628-50B*
2627.3 MCM	1.762" (44.75 mm)	64 x 19	Santee/ACSS/TW		1628-50D*

Wire Pulling Grips



*Klein Tools recommends using the 1628-50 series grips for ACSS and ACSS/TW cable. Special order only. Application must be confirmed prior to ordering. Please allow 30 days for delivery. Jaw must be removed to insert cable.

AAC (All Aluminum Conductor)

For Cable Diameter

4 AWG - 650 MCM

.231" - .928" (5.87 mm - 23.57 mm)

MAXIMUM SAFE LOAD

See facing page for grip details.

AWG or MCM Cable Size	Diameter inches (mm)	No. of Alum. Strands	Code Word	MAXIMUM SAFE LOAD			
				A 4,500 lbs (2041 kg)	B 8,000 lbs (3629 kg)	C 15,000 lbs (6803 kg)	D 20,000 lbs (9072 kg)
				Cat. No.	Cat. No.	Cat. No.	Cat. No.
4	.231" (5.87 mm)	7	Rose	1656-20, 1656-20H and S1656-20H			
2	.292" (7.42 mm)	7	Iris	1656-20, 1656-20H and S1656-20H			
1	.328" (8.33 mm)	7	Pansy	1656-20, 1656-20H, S1656-20H, 1656-30, 1656-30H and S1656-30H		1628-16PE*	
1/0	.369" (9.36 mm)	7	Poppy	1656-20, 1656-20H, S1656-20H, 1656-30, 1656-30H and S1656-30H		1628-16PF*	
2/0	.414" (10.51 mm)	7	Aster	1656-30, 1656-30H and S1656-30H		1628-16PG*	
3/0	.465" (11.81 mm)	7	Phlox	1656-30, 1656-30H and S1656-30H		1628-16PH*	
4/0	.522" (13.25 mm)	7	Oxlip	1656-30, 1656-30H and S1656-30H		1628-16PI*	
250 MCM	.567" (14.40 mm)	7	Sneezewort		1656-40, 1656-40H and S1656-40H	1628-16PI*	
250 MCM	.574" (14.58 mm)	19	Valerian		1656-40, 1656-40H and S1656-40H	1628-16PI*	
266.8 MCM	.586" (14.88 mm)	7	Daisy		1656-40, 1656-40H and S1656-40H	1628-16PJ*	
266.8 MCM	.593" (15.05 mm)	19	Laurel		1656-40, 1656-40H and S1656-40H	1628-16PJ*	
300 MCM	.628" (15.95 mm)	19	Peony		1656-40, 1656-40H and S1656-40H	1628-16PJ*	
336.4 MCM	.665" (16.90 mm)	19	Tulip		1656-40, 1656-40H and S1656-40H	1628-16PK*	
350 MCM	.678" (17.22 mm)	19	Daffodil		1656-40, 1656-40H and S1656-40H	1628-16PK*	
397.5 MCM	.724" (18.38 mm)	19	Canna		1656-40, 1656-40H and S1656-40H	1628-16PL*	
450 MCM	.769" (19.53 mm)	19	Goldentuft		1656-50, 1656-50H and S1656-50H	1628-16PM*	
477 MCM	.792" (20.12 mm)	19	Cosmos		1656-50, 1656-50H and S1656-50H	1628-16PM*	
477 MCM	.794" (20.18 mm)	37	Syringa		1656-50, 1656-50H and S1656-50H	1628-16PM*	
500 MCM	.811" (20.60 mm)	19	Zinnia		1656-50, 1656-50H and S1656-50H	1628-16PM*	
500 MCM	.813" (20.65 mm)	37	Hyacinth		1656-50, 1656-50H and S1656-50H	1628-16PM*	
556.5 MCM	.856" (21.73 mm)	19	Dahlia		1656-50, 1656-50H and S1656-50H	1628-16PN*	1628-30N*
556.5 MCM	.858" (21.80 mm)	37	Mistletoe		1656-50, 1656-50H and S1656-50H	1628-16PN*	1628-30N*
600 MCM	.891" (22.63 mm)	37	Meadowsweet		1656-60, 1656-60H and S1656-60H		1628-300*
636 MCM	.918" (23.31 mm)	37	Orchid		1656-60, 1656-60H and S1656-60H		1628-300*
650 MCM	.928" (23.57 mm)	37	Heuchera		1656-60, 1656-60H and S1656-60H		1628-300*

"S" is for spring. "H" is for hot latch.

*Special order only. Please allow 30 days for delivery. These are not returnable.

All dimensions are in inches and (millimeters) unless otherwise specified.

WARNING: Grips are to be used for temporary installation, not for permanent anchorage.

WARNING: When used on/or near energized lines, ground, insulate, or isolate grip before pulling.

WARNING: Do not exceed rated capacity.

WARNING: Always match proper size and type of grip to application.

WARNING: Before each use, clean jaw area and inspect grip for proper operation to avoid slippage.



AAC (All Aluminum Conductor)

Chicago® Grip – 1656 Series

- Round, smooth inside jaw contour on this series of grips is recommended for bare AAC.
- Smooth jawed grips with maximum contact are less likely to cause cable deformation.



1656-30



1656-40H

A 4,500 lbs. (2,041 kg) Maximum Safe Load

Cat. No.	Hot Latch Model No.	Hot Latch/Spring Model No.	Min. to Max. Cable AWG	Min. to Max. Cable Diameter inches (mm)	Jaw Length	Approx. Weight Each
1656-20	1656-20H	S1656-20H	4 - 1/0	.231" - .369" (5.87 mm - 9.37 mm)	4" (102 mm)	3 lbs. (1.36 kg)
1656-30	1656-30H	S1656-30H	1 - 4/0	.328" - .522" (8.33 mm - 13.26 mm)	4-3/4" (121 mm)	3.75 lbs. (1.70 kg)

B 8,000 lbs. (3,629 kg) Maximum Safe Load

Cat. No.	Hot Latch Model No.	Hot Latch/Spring Model No.	Min. to Max. Cable MCM	Min. to Max. Cable Diameter inches (mm)	Jaw Length	Approx. Weight Each
1656-40	1656-40H	S1656-40H	250 MCM - 397.5 MCM	.567" - .724" (14.40 mm - 18.39 mm)	5-1/2" (140 mm)	8.30 lbs. (3.76 kg)
1656-50	1656-50H	S1656-50H	450 MCM - 556.5 MCM	.769" - .858" (19.53 mm - 21.79 mm)	5-1/2" (140 mm)	8.30 lbs. (3.76 kg)
1656-60	1656-60H	S1656-60H	600 MCM - 650 MCM	.891" - .928" (22.63 mm - 23.57 mm)	5-1/2" (140 mm)	8.20 lbs (3.71 kg)

Chicago® Grip – 1628-16P and 1628-30 Series

- Designed for large-diameter AAC cables.
- Round jaws are shaped to provide maximum contact with the cable, virtually eliminating cable deformation.

C 15,000 lbs. (6,803 kg) Maximum Safe Load

Cat. No.	Min. to Max. Cable AWG or MCM	Min. to Max. Cable Diameter inches (mm)	Jaw Length	Approx. Weight Each
1628-16PE*	1	.328" (8.33 mm)	7-1/4" (184 mm)	17 lbs. (7.73 kg)
1628-16PF*	1/0	.369" (9.37 mm)	7-1/4" (184 mm)	17 lbs. (7.73 kg)
1628-16PG*	2/0	.414" (10.52 mm)	7-1/4" (184 mm)	17 lbs. (7.73 kg)
1628-16PH*‡	3/0	.465" (11.81 mm)	7-1/4" (184 mm)	17 lbs. (7.73 kg)
1628-16PI*	250 MCM	.567" - .574" (14.40 mm - 14.58 mm)	7-1/4" (184 mm)	17 lbs. (7.73 kg)
1628-16PJ*	266.8 MCM - 300 MCM	.586" - .628" (14.88 mm - 15.95 mm)	7-1/4" (184 mm)	17 lbs. (7.73 kg)
1628-16PK*	336.4 MCM - 350 MCM	.665" - .678" (16.89 mm - 17.22 mm)	7-1/4" (184 mm)	17 lbs. (7.73 kg)
1628-16PL*	397.5 MCM	.724" (18.39 mm)	7-1/4" (184 mm)	17 lbs. (7.73 kg)
1628-16PM*	450 MCM - 500 MCM	.769" - .813" (19.53 mm - 20.65 mm)	7-1/4" (184 mm)	17 lbs. (7.73 kg)
1628-16PN*	556.5 MCM	.856" - .858" (21.74 mm - 21.79 mm)	7-1/4" (184 mm)	17 lbs. (7.73 kg)



1628-16P

‡ The "H" suffix does not mean Hot Latch, this is only for Cat. No. 1628-16PH



1628-30

D 20,000 lbs. (9,072 kg) Maximum Safe Load

Cat. No.	Min. to Max. Cable MCM	Min. to Max. Cable Diameter inches (mm)	Jaw Length	Approx. Weight Each
1628-30N**	556.5 MCM	.856" - .858" (21.74 mm - 21.79 mm)	10-3/4" (273 mm)	27 lbs. (12.27 kg)
1628-300**	600 MCM - 650 MCM	.891" - .928" (22.63 mm - 23.57 mm)	10-3/4" (273 mm)	27 lbs. (12.27 kg)

** Maximum safe stringing tension 12,500 lbs to minimize cable deformation.

*These grips are special order only. Please allow 30 days for delivery. These are not returnable.

All dimensions are in inches and (millimeters) unless otherwise specified.

▲WARNING: See facing page.



AAC (All Aluminum Conductor)

See facing page
for grip details.

For Cable Diameter

700 - 2500 MCM

.963" - 1.823" (24.46 mm - 46.30 mm)

MCM Cable Size	Diameter inches (mm)	No. of Alum. & Steel Strands	Code Word	Cat. No.	C	D	E
					20,000 lbs (9,072 kg)	25,000 lbs (11,340 kg)	25,000 lbs. (11,340 kg) with bolt on jaw
					Cat. No.	Cat. No.	Cat. No.
700 MCM	.963" (24.46 mm)	37	Verbena	1628-30P*			1628-50P*
700 MCM	.964" (24.49 mm)	61	Flag	1628-30P*			1628-50P*
715.5 MCM	.974" (24.73 mm)	37	Violet	1628-30P*			1628-50P*
715.5 MCM	.975" (24.76 mm)	61	Nasturtium	1628-30P*			1628-50P*
750 MCM	.997" (25.32 mm)	37	Petunia	1628-30P*			1628-50P*
750 MCM	.998" (25.35 mm)	61	Cattail	1628-30P*			1628-50P*
795 MCM	1.026" (26.07 mm)	37	Arbutus	1628-30R*			1628-50R*
795 MCM	1.028" (26.11 mm)	61	Lilac	1628-30R*			1628-50R*
800 MCM	1.029" (26.14 mm)	37	Fuchsia	1628-30R*			1628-50R*
800 MCM	1.031" (26.19 mm)	61	Heliotrope	1628-30R*			1628-50R*
874.5 MCM	1.076" (27.37 mm)	37	Anemone	1628-30R*			1628-50R*
874.5 MCM	1.077" (27.36 mm)	61	Crocus	1628-30R*			1628-50R*
900 MCM	1.092" (27.74 mm)	37	Cockscomb	1628-30S*			1628-50S*
954 MCM	1.124" (28.55 mm)	37	Magnolia	1628-30S*			1628-50S*
954 MCM	1.126" (28.60 mm)	61	Goldenrod	1628-30S*			1628-50S*
1000 MCM	1.152" (29.26 mm)	61	Camellia	1628-30T*			1628-50T
1000 MCM	1.152" (29.26 mm)	37	Hawkweed	1628-30T*			1628-50T*
1033.5 MCM	1.170" (29.71 mm)	37	Bluebell	1628-30T*			1628-50T*
1033.5 MCM	1.172" (29.76 mm)	61	Larkspur	1628-30T*			1628-50T*
1113 MCM	1.216" (30.88 mm)	61	Marigold	1628-30U*	1628-40U*		1628-50U*
1192.5 MCM	1.258" (31.96 mm)	61	Hawthorn	1628-30U*	1628-40U*		1628-50U*
1272 MCM	1.297" (32.94 mm)	61	Narcissus		1628-40W*		1628-50W*
1351.5 MCM	1.339" (34.02 mm)	61	Columbine		1628-40X*		1628-50X*
1431 MCM	1.379" (35.02 mm)	61	Carnation		1628-40X*		1628-50X*
1510.5 MCM	1.417" (35.98 mm)	61	Gladiolus		1628-40Y*		1628-50Y*
1590 MCM	1.454" (36.93 mm)	61	Coreopsis		1628-40Z*		1628-50Z*
1750 MCM	1.524" (38.72 mm)	61	Jessamine		1628-40A*		1628-50A*
2000 MCM	1.630" (41.41 mm)	91	Cowslip				1628-50B*
2250 MCM	1.729" (43.92 mm)	91	Sagebrush				1628-50D*
2500 MCM	1.823" (46.30 mm)	91	Lupine				1628-50E*

** Maximum safe stringing tension 12,500 lbs to minimize cable deformation.

* Special order. Please allow 30 days for delivery. These are not returnable.

Wire Pulling Grips



All dimensions are in inches and (millimeters) unless otherwise specified.

WARNING: Grips are to be used for temporary installation, not for permanent anchorage.

WARNING: When used on/or near energized lines, ground, insulate, or isolate grip before pulling.

WARNING: Do not exceed rated capacity.

WARNING: Always match proper size and type of grip to application.

WARNING: Before each use, clean jaw area and inspect grip for proper operation to avoid slippage.

AAC (All Aluminum Conductor)

Chicago® Grip – 1628 Series

- Round jaws are shaped to provide maximum contact with the cable, virtually eliminating cable deformation.

C 20,000 lbs. (9,072 kg) Maximum Safe Load

Cat. No.	Min. to Max. Cable MCM	Min. to Max. Cable Diameter inches (mm)	Jaw Length	Approx. Weight Each
1628-30P*	700 MCM - 750 MCM	.963" - .998" (24.46 mm - 25.35 mm)	10-3/4" (273 mm)	27 lbs. (12.27 kg)
1628-30R*	795 MCM - 874.5 MCM	1.026" - 1.077" (26.06 mm - 27.36 mm)	10-3/4" (273 mm)	27 lbs. (12.27 kg)
1628-30S*	900 MCM - 954 MCM	1.092" - 1.126" (27.74 mm - 28.60 mm)	10-3/4" (273 mm)	27 lbs. (12.27 kg)
1628-30T*	1000 MCM - 1033.5 MCM	1.152" - 1.172" (29.26 mm - 29.77 mm)	10-3/4" (273 mm)	27 lbs. (12.27 kg)
1628-30U*	1113 MCM - 1192.5 MCM	1.216" - 1.258" (30.89 mm - 31.95 mm)	10-3/4" (273 mm)	27 lbs. (12.27 kg)



1628-30

D 25,000 lbs. (11,340 kg) Maximum Safe Load

Cat. No.	Min. to Max. Cable MCM	Min. to Max. Cable Diameter inches (mm)	Jaw Length	Approx. Weight Each
1628-40U*	1113 MCM - 1192.5 MCM	1.216" - 1.258" (30.89 mm - 31.95 mm)	10-3/4" (273 mm)	34 lbs. (15.45 kg)
1628-40W*	1272 MCM	1.297" (32.94 mm)	10-3/4" (273 mm)	34 lbs. (15.45 kg)
1628-40X*	1351.5 MCM - 1431 MCM	1.339" - 1.379" (34.01 mm - 35.03 mm)	10-3/4" (273 mm)	34 lbs. (15.45 kg)
1628-40Y*	1510.5 MCM	1.417" (35.99 mm)	10-3/4" (273 mm)	34 lbs. (15.45 kg)
1628-40Z*	1590 MCM	1.454" (36.93 mm)	10-3/4" (273 mm)	34 lbs. (15.45 kg)
1628-40A*	1750 MCM	1.524" (38.71 mm)	10-3/4" (273 mm)	34 lbs. (15.45 kg)



1628-40

E 25,000 lbs. (11,340 kg) Maximum Safe Load with bolt on jaw

Cat. No.	Min. to Max. Cable MCM	Min. to Max. Cable Diameter inches (mm)	Jaw Length	Approx. Weight Each
1628-50P*	700 MCM - 750 MCM	.963" - .998" (24.46 mm - 25.35 mm)	10-3/4" (273 mm)	34 lbs. (15.45 kg)
1628-50R*	795 MCM - 874.5 MCM	1.026" - 1.077" (26.06 mm - 27.36 mm)	10-3/4" (273 mm)	34 lbs. (15.45 kg)
1628-50S*	900 MCM - 954 MCM	1.092" - 1.126" (27.74 mm - 28.60 mm)	10-3/4" (273 mm)	34 lbs. (15.45 kg)
1628-50T*	1000 MCM - 1033.5 MCM	1.152" - 1.172" (29.26 mm - 29.77 mm)	10-3/4" (273 mm)	34 lbs. (15.45 kg)
1628-50U*	1113 MCM - 1192.5 MCM	1.216" - 1.258" (30.89 mm - 31.95 mm)	10-3/4" (273 mm)	34 lbs. (15.45 kg)
1628-50W*	1272 MCM	1.297" (32.94 mm)	10-3/4" (273 mm)	34 lbs. (15.45 kg)
1628-50X*	1351.5 MCM - 1431 MCM	1.339" - 1.379" (34.01 mm - 35.03 mm)	10-3/4" (273 mm)	34 lbs. (15.45 kg)
1628-50Y*	1510.5 MCM	1.417" (35.99 mm)	10-3/4" (273 mm)	34 lbs. (15.45 kg)
1628-50Z*	1590 MCM	1.454" (36.93 mm)	10-3/4" (273 mm)	34 lbs. (15.45 kg)
1628-50A*	1750 MCM	1.524" (38.71 mm)	10-3/4" (273 mm)	34 lbs. (15.45 kg)
1628-50B*	2000 MCM	1.630" (41.40 mm)	10-3/4" (273 mm)	34 lbs. (15.45 kg)
1628-50D*	2250 MCM	1.729" (43.92 mm)	10-3/4" (273 mm)	34 lbs. (15.45 kg)
1628-50E*	2500 MCM	1.823" (46.30 mm)	10-3/4" (273 mm)	34 lbs. (15.45 kg)

*These grips are special order only. Please allow 30 days for delivery. These are not returnable.

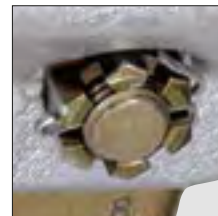

- Removable bolt on floating jaw, secured by a slotted nut and cotter pin. Jaw provides increased cable coverage.

Note: Jaw must be removed to insert cable.



Copper – Chicago® Grips

Bare Stranded Chicago® Grips – 1656 Series

- Round, smooth inside jaw contour on this series of grips is ideal for stranded-copper cables.
- Smooth jaws grip with maximum contact are less likely to cause cable deformation.



1656-30

Cat. No.	Hot Latch Model No.	Hot Latch/Spring Model No.	Min. to Max. Cable Diameter inches (mm)	Jaw Length	Approx. Weight Each
4,500 lbs. (2,041 kg) Maximum Safe Load					
1656-20	1656-20H	S1656-20H	.20" - .40" (5.08 mm - 10.16 mm)	4" (102 mm)	3 lbs. (1.36 kg)
1656-30	1656-30H	S1656-30H	.31" - .53" (7.87 mm - 13.46 mm)	4 3/4" (121 mm)	3.75 lbs (1.70 kg)
8,000 lbs. (3,629 kg) Maximum Safe Load					
1656-40	1656-40H	S1656-40H	.53" - .74" (13.46 mm - 18.80 mm)	5 1/2" (140 mm)	8.30 lbs (3.76 kg)
1656-50	1656-50H	S1656-50H	.74" - .86" (18.80 mm - 21.84 mm)	5 1/2" (140 mm)	8.30 lbs (3.76 kg)
1656-60	1656-60H	S1656-60H	.86" - .96" (21.84 mm - 24.38 mm)	5 1/2" (140 mm)	8.20 lbs (3.71 kg)



Weatherproof Stranded and Solid Chicago® Grips – 1611 Series

- Round inside jaw contour for weatherproof coated wire.
- Notches in jaw provide firm grip on insulation.



Notched Jaw



1611-30

Cat. No.	Min. to Max. Cable Diameter inches (mm)	Jaw Length	Approx. Weight Each
4,500 lbs. (2,041 kg) Maximum Safe Load			
1611-20	.20" - .40" (5.08 mm - 10.16 mm)	4-3/16" (106 mm)	3 lbs. (1.36 kg)
1611-30	.31" - .53" (7.87 mm - 13.46 mm)	4-3/4" (121mm)	3.75 lbs (1.70 kg)
8,000 lbs. (3,629 kg) Maximum Safe Load			
1611-40	.53" - .74" (13.46 mm - 18.80 mm)	5-11/16" (144 mm)	7.75 lbs (3.52 kg)
1611-50	.74" - .86" (18.80 mm - 21.84 mm)	5-11/16" (144 mm)	7.75 lbs (3.52 kg)

Note: Due to various types of weatherproof coatings available, selection of proper grips is determined by outside diameter of cable.

PVC-Covered Chicago® Grips – 1659 Series

- Specially machined serpentine jaws allow insulated conductor to be inserted through jaws.
- Eliminates necessity of stripping insulation from conductor.
- Round inside-jaw contour.



Serpentine Jaw

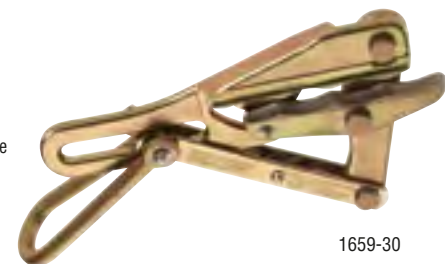

1659-30

Cat. No.	Min. to Max. Cable Diameter inches (mm)	Jaw Length	Approx. Weight Each
4,500 lbs. (2,041 kg) Maximum Safe Load			
1659-20	.20" - .42" (5.08 mm - 10.67 mm)	4-3/16" (106 mm)	3 lbs. (1.36 kg)
1659-30	.31" - .50" (7.87 mm - 12.70 mm)	4-3/4" (121 mm)	3.75 lbs (1.70 kg)
8,000 lbs. (3,629 kg) Maximum Safe Load			
1659-40	.49" - .79" (12.45 mm - 20.07 mm)	5-11/16" (144 mm)	7.75 lbs (3.52 kg)
1659-50	.79" - 1.01" (20.07 mm - 25.56 mm)	5-11/16" (144 mm)	7.75 lbs (3.52 kg)

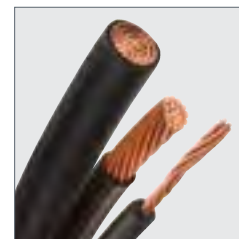

All dimensions are in inches and (millimeters) unless otherwise specified.

⚠WARNING: Grips are to be used for temporary installation, not for permanent anchorage.

⚠WARNING: When used on/or near energized lines, ground, insulate, or isolate grip before pulling.

⚠WARNING: Do not exceed rated capacity.

⚠WARNING: Always match proper size and type of grip to application.

⚠WARNING: Before each use, clean jaw area and inspect grip for proper operation to avoid slippage.



Steel Strand – Chicago® Grips

Bell System B, L, and H Chicago® Grips – 1628, 1659, 1684 & 1692 Series

- All are equipped with chain, toggle and shackle - keeps the grip from falling off of cable.
- 1659 - 5AT is similar to Bell-System type "B" Strand Puller. Designed to pull 1/4" (6.35 mm) figure-8 telephone cable. Also has serpentine jaw.
- 1684 - 5AT is identical to Bell-System type "L" Strand Puller.
- 1628 - 16AT is identical to Bell-System type "H" Strand Puller.

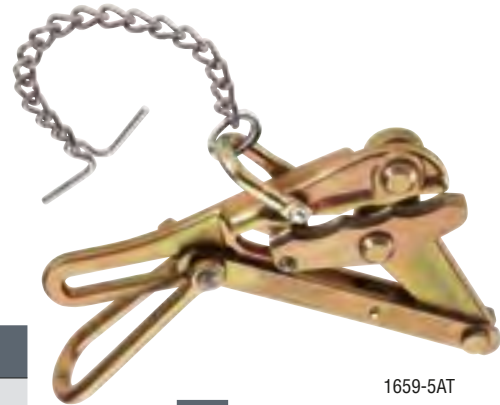

1659-5AT



Serpentine Jaw

Cat. No.	Min. to Max. Cable Diameter inches (mm)	Jaw Length	Approx. Weight Each
5,000 lbs. (2,268 kg) Maximum Safe Load			
1659-5AT ("B" Strand Puller)	.20" - .37" (5.08 mm - 9.40 mm)	5" (127mm)	6.70 lbs. (3.03 kg)
8,000 lbs. (3,629 kg) Maximum Safe Load			
1684-5AT ("L" Strand Puller)	.218" - .550" (5.54 mm - 13.97 mm)	5" (127mm)	6.9 lbs (3.13 kg)
1692-5AT ("L" Strand Puller)	.218" - .550" (5.54 mm - 13.97 mm)	5" (127mm)	6.6 lbs (3.00 kg)
15,000 lbs. (6,803 kg) Maximum Safe Load			
1628-16AT ("H" Strand Puller)	.31" - .62" (7.87 mm - 15.75 mm)	7 1/4" (184 mm)	15.80 lbs (7.16 kg)

*1692-5AT (larger clamping force than 1684-5AT)

Aircraft Cable, EHS (Extra-High-Strength), Messenger, and Guy Strand Chicago® Grips – 1613, 1628, 1684 and 1692 Series



1613-40

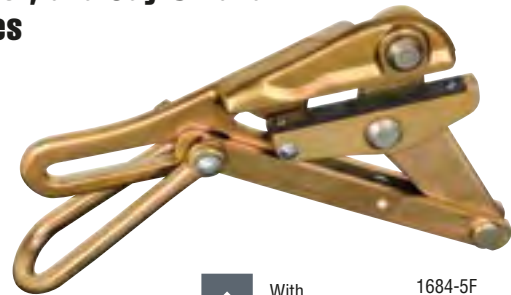

1684-5F



With file insert

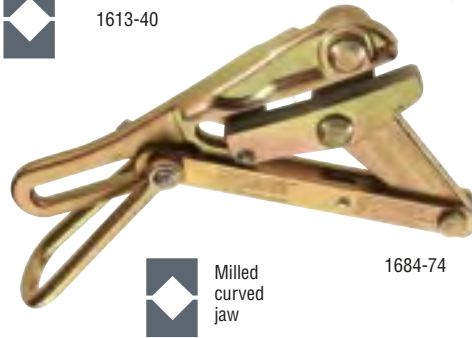

1684-74



Milled curved jaw

- A family of grips designed for cable sizes from .12" (3.10 mm) to 1" (25.4 mm).
- Double V grooves provide four-point contact, reducing chance of slipping and providing proper alignment of wire and cable. (1684-5F is a Single V with file insert.)



Replacement parts available: Screws (Cat. No. 573) and file (Cat. No. 578).

Cat. No.	Hot Latch Model No.	Hot Latch/Spring Model No.	Min. to Max. Cable Diameter inches (mm)	Jaw Length	Approx. Weight Each
4,500 lbs. (2,041 kg) Maximum Safe Load					
1613-40	1613-40H	S1613-40H	.12" - .37" (3.05 mm - 9.40 mm)	4-3/16" (106 mm)	3 lbs. (1.36 kg)
8,000 lbs. (3,629 kg) Maximum Safe Load					
1684-5F	NA	NA	.16" - .550" (4.06 mm - 13.97 mm)	5" (127 mm)	6.25 lbs. (2.84 kg)
1684-5	1684-5H	S1684-5H	.218" - .550" (5.54 mm - 13.97 mm)	5" (127 mm)	6.25 lbs. (2.84 kg)
1692-5 (larger clamping force than 1684-5)	NA	NA	.218" - .550" (5.54 mm - 13.97 mm)	5" (127 mm)	6.40 lbs. (2.89 kg)
8,000 lbs. (3,629 kg) Maximum Safe Load – EHS Specific					
1684-74 (Includes curved jaw)	NA	S1684-74H	.218" - .550" (5.54 mm - 13.97 mm)	5" (127 mm)	6.30 lbs. (2.85 kg)
15,000 lbs. (6,803 kg) Maximum Safe Load					
1628-16	NA	NA	.31" - .62" (7.87 mm - 15.75 mm)	7-1/4" (184 mm)	15.30 lbs. (7.00 kg)
1628-17	NA	NA	.50" - .75" (12.70 mm - 19.05 mm)	7-1/4" (184 mm)	16.30 lbs. (7.40 kg)
1628-18	NA	NA	.75" - 1.00" (19.05 mm - 25.40 mm)	7-1/4" (184 mm)	15.70 lbs. (7.10 kg)

All dimensions are in inches and (millimeters) unless otherwise specified.

WARNING: See facing page.



Copper/Steel Strand – Chicago® Grips

Bare Wire

Chicago® Grips – 1613 Series

- Designed for working with solid and stranded bare wire from .08" (2 mm) to .20" (5.1 mm).
- Lightweight, cost-effective grip.
- Single "V" groove jaw.

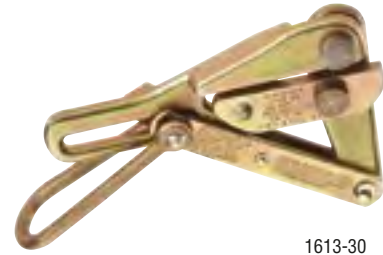

1613-30

Cat. No.	Minimum Cable	Maximum Cable	Maximum Safe Load	Jaw Length	Approx. Weight Each
1613-30	12 B&S solid .08" (2.03 mm)	4 B&S solid .20" (5.08 mm)	1500 lbs. (680 kg)	3" (76 mm)	1.50 lbs. (.68 kg)

Steel Strand – Haven's® Grips

Messenger and Guy Strand Haven's® Grips – 1604 Series

- Designed for use when light, compact grip is desired and where cable deformation is not a factor.
- Gripping pressure of the knurled jaw is applied to 1/4" (6.35 mm) cable area.



1604-20



1604-20L

Cat. No.	Latch Model	Min. to Max. Cable Diameter inches (mm)	Jaw Length	Approx. Weight Each
2,500 lbs. (1,134 kg) Maximum Safe Load				
1604-10	NA	.06" - .25" (1.52 mm - 6.35 mm)	N/A	1 lb. (.45 kg)
5,000 lbs. (2,268 kg) Maximum Safe Load				
1604-20	1604-20L	.125" - .50" (3.18 mm - 12.70 mm)	N/A	2.08 lbs. (1.14 kg)

Wire Rope

Haven's® Grips – 1625 Series

- Designed for use when light, compact grip is desired and where cable deformation is not a factor.
- Gripping pressure of the knurled jaw is applied to 1/4" (6.35 mm) cable area.
- All 1625 series have a swing latch to help hold cable in the jaw.

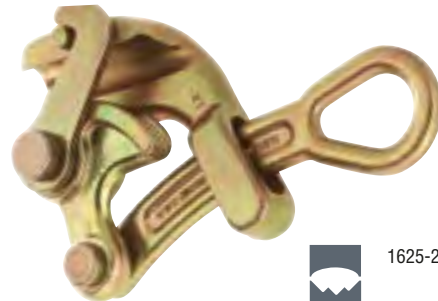

1625-20

Cat. No.	Min. to Max. Cable Diameter inches (mm)	Jaw Length	Approx. Weight Each
8,000 lbs. (3,629 kg) Maximum Safe Load			
1625-20	.28" - .75" (7.11 mm - 19.05 mm)	N/A	4 lbs. (1.81 kg)
1625-20 7/8	.38" - .88" (9.65 mm - 22.35 mm)	N/A	4 lbs. (1.81 kg)
1625-20 1	.50" - 1.00" (12.70 mm - 25.40 mm)	N/A	4 lbs. (1.81 kg)

All dimensions are in inches and (millimeters) unless otherwise specified.

⚠WARNING: Grips are to be used for temporary installation, not for permanent anchorage.

⚠WARNING: When used on/or near energized lines, ground, insulate, or isolate grip before pulling.

⚠WARNING: Do not exceed rated capacity.

⚠WARNING: Always match proper size and type of grip to application.

⚠WARNING: Before each use, clean jaw area and inspect grip for proper operation to avoid slippage.



Wide Range of Cables

Parallel Jaw Grips – KT4500, KT4600 and KT4800 Series



KT4500



KT4650

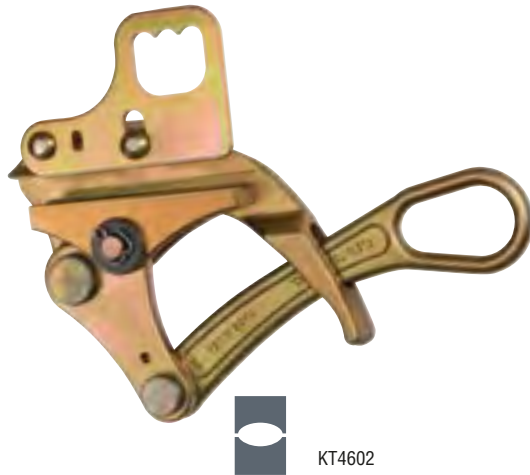

KT4602



KT4800

- The KT4500, KT4600 and KT4800 Series feature a round serrated jaw.
- KT4501, KT4502, KT4601, KT4602, KT4801, KT4802 are supplied with hot latches.
- Hot latch closes automatically to guard against grip accidentally disengaging from wire.
- Large opening in the handle to accommodate a wide variety of hooks on hoists, winches and tackle blocks.

Cat. No.	Min. to Max. Cable Diameter inches (mm)	Hot Latch	Spring	Locking Handle	Jaw Length	Approx. Weight Each
5,000 lbs. (2,268 kg) Maximum Safe Load						
KT4500	.180" - .600" (4.57 mm - 15.2 mm)		●		4" (101.3 mm)	3.75 lbs. (1.70 kg)
KT4501	.180" - .600" (4.57 mm - 15.2 mm)	●	●	●	4" (101.3 mm)	3.75 lbs. (1.70 kg)
KT4502	.180" - .600" (4.57 mm - 15.2 mm)	●			4" (101.3 mm)	3.75 lbs. (1.70 kg)
KT4650	.160" - .900" (4.00 mm - 23.0 mm)		●		4-1/2" (114 mm)	4.90 lbs. (2.22 kg)
KT4652	.160" - .900" (4.00 mm - 23.0 mm)	●	●		4-1/2" (114 mm)	4.90 lbs. (2.22 kg)
10,000 lbs. (4,536 kg) Maximum Safe Load						
KT4600	.300" - .800" (7.62 mm - 20.3 mm)		●		5" (127 mm)	7 lbs. (3.18 kg)
KT4601	.300" - .800" (7.62 mm - 20.3 mm)	●	●	●	5" (127 mm)	7 lbs. (3.18 kg)
KT4602	.300" - .800" (7.62 mm - 20.3 mm)	●			5" (127 mm)	7 lbs. (3.18 kg)
12,000 lbs. (5,443 kg) Maximum Safe Load						
KT4800	.700" - 1.25" (17.8 mm - 31.8 mm)		●		5-1/8" (130 mm)	9 lbs. (4.1 kg)
KT4801	.700" - 1.25" (17.8 mm - 31.8 mm)	●	●	●	5-1/8" (130 mm)	9 lbs. (4.1 kg)
KT4802	.700" - 1.25" (17.8 mm - 31.8 mm)	●			5-1/8" (130 mm)	9 lbs. (4.1 kg)

All dimensions are in inches and (millimeters) unless otherwise specified.

▲WARNING: Grips are to be used for temporary installation, not for permanent anchorage.

▲WARNING: When used on/or near energized lines, ground, insulate, or isolate grip before pulling.

▲WARNING: Do not exceed rated capacity.

▲WARNING: Always match proper size and type of grip to application.

▲WARNING: Before each use, clean jaw area and inspect grip for proper operation to avoid slippage.



Wide Range of Cables

Parallel Jaw Grips – 1685 Series

- Lightweight, compact grips pull an exceptionally wide range of cable types and sizes.
- Designed with a round inside-jaw contour for maximum contact to minimize cable deformation.
- Lower jaw is serrated to firmly grip insulated cables and conductors.
- Design includes a latch that prevents the grip from falling in case of jaw disengagement from the cable.
- Large-diameter eye accommodates large hooks on hoists, winches and tackle blocks.

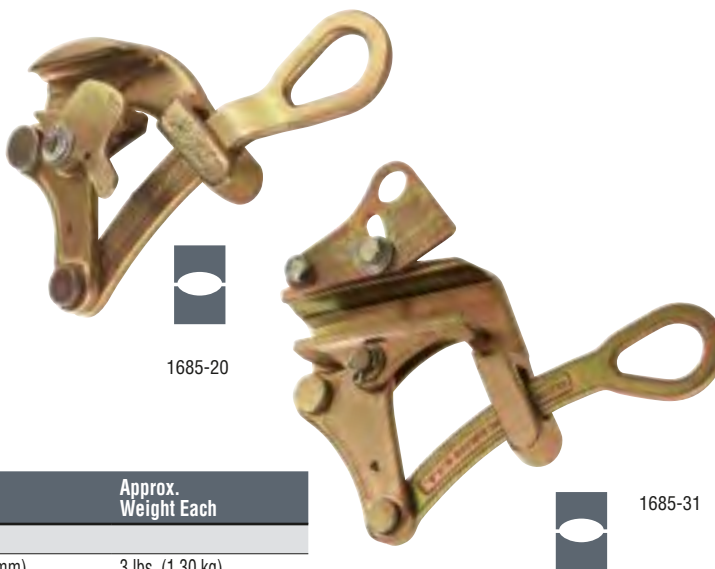

1685-20

1685-31

Cat. No.	Min. to Max. Cable Diameter inches (mm)	Jaw Length	Approx. Weight Each
4,500 lbs. (2,041 kg) Maximum Safe Load			
1685-20	.157" - .875" (4 mm - 22 mm)	2-1/2" (64 mm)	3 lbs. (1.30 kg)
7,500 lbs. (3,400 kg) Maximum Safe Load			
1685-31	.625" - 1.250" (16 mm - 32 mm)	4-1/2" (114 mm)	5 lbs. (2.27 kg)

Parallel Jaw Grips – 1686-10, 1686-20, 1671-10 and 1672-10

- Longer jaws achieve a firm hold, reducing possibility of slippage and deformation to cable.
- Designed with a Double V jaw contour, a latch, plus a large-diameter eye that accommodates large hooks on hoists, winches, and tackle blocks.
- When latch is closed, it helps maintain cable position in grip jaws.



1672-10

Cat. No.	Min. to Max. Cable Diameter inches (mm)	Jaw Length	Approx. Weight Each
10,000 lbs. (4,536 kg) Maximum Safe Load			
1686-10	.20" - .40" (5.08 mm - 10.16 mm)	4-3/8" (111 mm)	5 lbs. (2.27 kg)
1686-20	.20" - .40" (5.08 mm - 10.16 mm)	4-3/8" (111 mm)	5 lbs. (2.27 kg)
Knurled Jaw			
1671-10	.37" - .75" (9.40 mm - 19.05 mm)	4-3/8" (111 mm)	5 lbs. (2.27 kg)
1672-10	.37" - .75" (9.40 mm - 19.05 mm)	4-3/8" (111 mm)	5 lbs. (2.27 kg)
Knurled Jaw			

All dimensions are in inches and (millimeters) unless otherwise specified.

⚠WARNING: Grips are to be used for temporary installation, not for permanent anchorage.

⚠WARNING: When used on/or near energized lines, ground, insulate, or isolate grip before pulling.

⚠WARNING: Do not exceed rated capacity.

⚠WARNING: Always match proper size and type of grip to application.

⚠WARNING: Before each use, clean jaw area and inspect grip for proper operation to avoid slippage.



Interchangeable Jaw Grips & Liners

Interchangeable Jaw Grips & Liners

- Constructed of high strength alloy steel, hot forged, heat treated, and galvanized for toughness, strength and corrosion resistance.
- Suitable for Optical Ground Wire (OPGW) conductors .236" to .906" (6 mm - 23 mm) (Cat. No. 1628-80).
- Offers a full range of interchangeable liners to be inserted between the upper and lower jaws of the grip.



1628-60



1628-80



Lower liner – Aluminum
Upper liner – Aluminum
(Cat. No. 1628-60)



Lower liner – Polyurethane
(provides cushioning for the optical cable)
Upper liner – Aluminum
(Cat. No. 1628-80)

- Liners are made to order. Call customer service with details of cable diameter, cable type and working load requirements for availability and lead time.

Cat. No.	Description	Cable Diameter Range	Maximum Working Load	Recommended For:	Weight
1628-60	1628-60 grip body only	.394" to 1.614" (10 mm to 41 mm)	6,750 lbs. (3060 kg.)	conductor cable	38 lbs. (17 kg.)
1628-80	1628-80 OPGW grip body only	.236" to .906" (6 mm to 23 mm)	6,750 lbs. (3060 kg.)	OPGW	15 lbs. (7 kg.)

▲WARNING: Grips are to be used for temporary installation, not for permanent anchorage.

▲WARNING: When used on/or near energized lines, ground, insulate, or isolate grip before pulling.

▲WARNING: Do not exceed capacity.

All dimensions are in inches and (millimeters) unless otherwise specified.

▲WARNING: Always match proper size and type of grip to application.

▲WARNING: Before each use, clean jaw area and inspect grip for proper operation to avoid slippage.



Accessories

Grip-Cleaning Brush Set

- Set of four wire-bristle brushes designed for cleaning Klein wire and cable-pulling grips.
- Brushes have stiff wire bristles.
- Available in round and square shapes and two lengths for efficient cleaning of different jaw configurations.
- Semi-flexible steel shafts set into comfortable wooden handles provide the necessary reach into grip jaws.



25450

Cat. No.	Set Contains	Weight (lbs.)
25450		1.00

Description	Bristle Diameter and Length	Overall Length
round-bristle	3/8" x 3" (10 mm x 76 mm)	12" (305 mm)
square-bristle	3/8" x 3" (10 mm x 76 mm)	12" (305 mm)
round-bristle	1-9/16" x 5" (40 mm x 127 mm)	14" (356 mm)
square-bristle	1-9/16" x 5" (40 mm x 127 mm)	14" (356 mm)

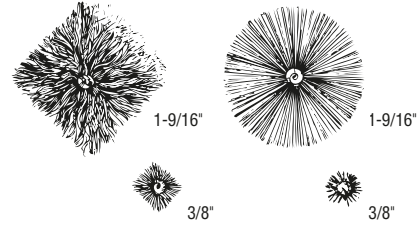

Introduction – Wire-Mesh Grips

Klein mesh pulling-grips are used for pulling overhead or underground cable, for stringing service or communication lines into buildings, for pulling wire through conduit, and for general underground construction.

Klein grips may be used for pulling bare or insulated wires, and wire rope. They install quickly and easily, and are designed to pass readily through ducts, conduit, blocks, and sheaves.

Klein grips are reusable and do not damage the cable because pulling tension remains uniform along the length of the grip. The mesh will fit either a single cable, or a bundle of cables.

Klein pulling grips are woven of galvanized steel – strong and long lasting.

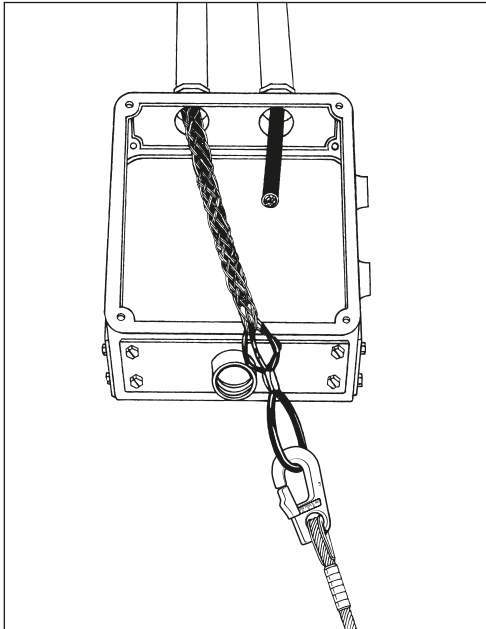

General Application Information

KPJ junior-duty series is used for small-job requirements where pulling tensions are low. Typical uses are to connect insulated building wire bundles to pulling tape, and pull through conduit.

KPL light duty grips are economical for applications such as industrial plant wiring and rewiring jobs, and in underground electrical construction where pulling tensions are low.

KSRK light-duty slack-pulling grips are split mesh, single-weave design with rod closure for quick installation. Application areas similar to KSSK series, except mesh lengths are shorter and are for lower pulling loads.

KPM medium-duty grips are flexible and easily handled, ideal for use where the exceptional strength of heavy-duty grips is not required.

KSCK medium-duty slack-pulling grips with closed double-weave mesh are used for final placement of underground cable where cable end is available, or for removing cable. Standard lengths are used in restricted space for short pulls. Where space is not restricted, longer lengths are used for higher pulling loads.

KSSK medium-duty slack-pulling grip applications are similar to the KSCK series except they are used where cable end is not available. Double-weave split mesh has lace closure.

KP heavy-duty grip series are recommended for underground installations.

KPS heavy-duty grip series are also recommended for underground installations. An additional feature of the KPS includes “rotating eye” to allow twists in the cable to spin out during slack periods.

Prefix Letter Code

KPJ	Pulling, Junior-Duty, Closed-Mesh, Single-Weave, Light Duty, Flexible Eye
KPL	Pulling, Closed-Mesh, Single-Weave, Flexible Eye
KSRK	Slack-Pulling, Light-Duty, Split-Mesh, Single-Weave, Rod Closure, Offset Flexible Eye
KPM	Pulling, Medium-Duty, Closed-Mesh, Double-Weave, Flexible Eye
KSCK	Slack-Pulling, Medium Duty, Closed-Mesh, Double-Weave, Offset Flexible Eye
KSSK	Slack-Pulling, Medium Duty, Split-Mesh, Double-Weave, Lace Closure, Offset Flexible Eye
KP	Pulling, Heavy-Duty, Closed-Mesh, Double-Weave, Flexible Eye
KPS	Pulling, Heavy-Duty, with Rotating Eye, Closed-Mesh, Double-Weave

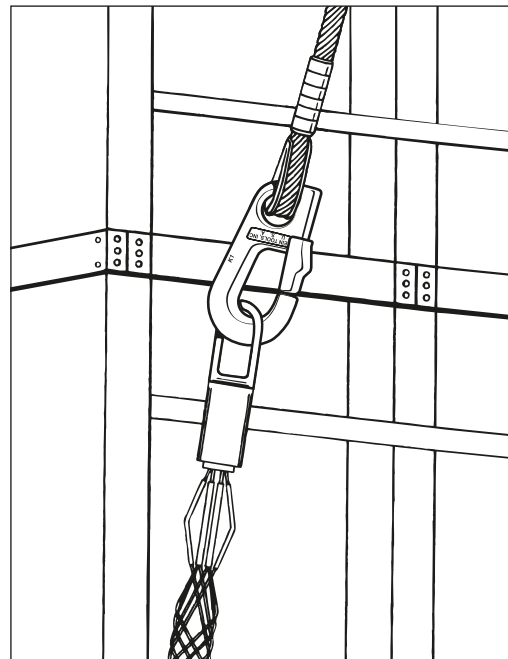

Catalog Number Explanation

KPS	—	050	—	2
Grip Type* and Mesh		Cat. No.** Size Code		Final Digit, if any, refers to mesh length range or actual dimension.

* See Prefix Letter Code explanation.

** On Junior-duty grips, initial digit “0” is omitted in Cat. No.

Example:

Cat. No. KPS-050-2 is a heavy-duty pulling grip with a rotating eye, for use with cable diameters from .50" to .61", with medium-length mesh.

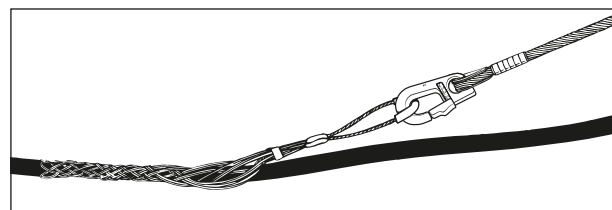

Introduction – Wire-Mesh Grips

How to select proper grip eye and mesh type

There are three basic styles of pulling grips, together with a choice of wire mesh types and lengths to meet a wide variety of pulling requirements.

1. Flexible Eye: Closed Mesh

KPJ/KPL/KPM/KP

This pulling-grip eye allows maximum flexibility to follow the line of pull, and is used when the end of the cable is available. Mesh selection depends on the weight of the material being pulled. Closed-mesh, single weave, flexible-eye grips are offered in lengths for junior-duty and light-duty use; closed-mesh, double-weave, flexible-eye grips are offered for medium-duty and heavy-duty use.

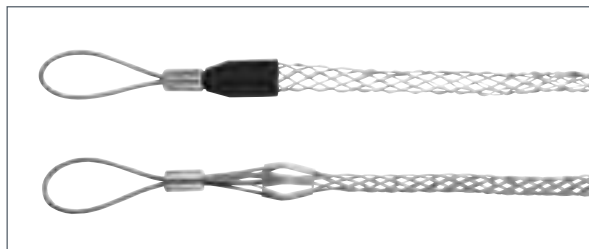

2. Rotating Eye: Closed Mesh

KPS

Recommended for heavier pulling jobs and underground wiring, this pulling grip eye is furnished on double-weave mesh grips in a wide range of lengths. The rotating eye compensates for pulling torque, relieving strain on the cable. **Rotating-eye grips should not be used on rope or as a swivel.**



3. Offset Flexible Eye: Split and Closed Mesh

KSRK/KSCK/KSSK

These slack-pulling grips come in three styles:

KSRK single-weave split-mesh with rod closure (light duty, where cable end is not available),

KSCK double-weave closed-mesh (for medium duty, where the end of the cable is available),

KSSK double-weave split-mesh with lace closure (medium duty, where cable end is not available).

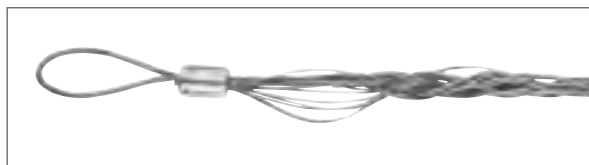

How grips are attached to cable

Closed-mesh grips

Closed-mesh grips simply slip over the cable where the cable end is accessible.

Split-mesh grips

Split-mesh grips are used when the end of the cable is not available. The grip is folded around the cable, and secured with a wire lace or steel rod (supplied with the grip) as follows:

1. Split mesh with lace closure

Start at the lead end of the grip, threading the lace through the first two loops of the split, then pulling it through until ends are centered evenly. Cross the lace ends and thread through next two loops, and so on down the grip. Do not pull lacing too tight. Spacing of laced closure should be about the same as the mesh weave. When the end of the grip is reached, twist lacing strands tightly together; wrap ends of lace around grip, and twist again to secure. Excess may be cut off.

2. Split mesh with rod closure

Split-mesh grips with rod closure can be quickly installed. Simply wrap the grip around the cable, then thread the rod through the loops, using a cork-screw motion. To remove, pull the rod out, and the grip is ready for re-use.

Design Strength

Applications and conditions of use for Klein mesh pulling grips vary so widely that it is impossible to set any meaningful standard for “breaking strength.”

With wire-mesh pulling grips, the holding power achieved is directly related to the length of mesh. The longer the mesh, the firmer the grip on the cable. For smaller-diameter cable, or where the weight to be pulled is less, short mesh grips will serve the purpose.



Introduction – Wire-Mesh Grips

How to select the proper pulling grip for your application

1. Select the proper pulling-grip series (Prefix Letter Code...e.g. KPS) based on the "General Application Information" descriptions in the Wire-Mesh Grips Introduction on preceding pages.
2. Select grip size based on the outside diameter or circumference of the cable(s) to be pulled. Refer to reference tables (on this and following page) for convenience in determining cable diameters.
3. Use Pulling-Grip Selection Tables (on this and following page) to determine the "Size" portion of the Catalog Number for the cable diameter required. In the ordering tables (see following pages) this "Size" code is incorporated within the catalog number under the various grip-type classifications.

Table 1

Pulling Grip Selection Table for One or More Cables of Equal Diameter to Be Pulled in One Grip

1. Read across on top line for number of cables in one grip.
2. Read down for diameter of each cable.
3. Use Cat. No. size code to select catalog number of the required size grip.

Example:

3 Cables, each with diameter of 1.31" use grip with Cat. No. Size Code 250.

Cable Diameters in Decimal Inches

1 Cable	2 Cables	3 Cables	4 Cables	5 Cables	6 & 7 Cables	8 Cables	9 Cables	Cat. No. Size Code	Grip Diam. Range
0.25-0.37	0.16-0.25	0.15-0.22	0.12-0.20	0.11-0.14	0.10-0.11	0.09-0.10	0.06-0.09	025	0.12-0.37
0.37-0.50	0.25-0.36	0.22-0.33	0.20-0.28	0.14-0.25	0.11-0.25	0.10-0.20	0.09-0.19	037	0.37-0.50
0.50-0.62	0.27-0.36	0.26-0.33	0.24-0.28	0.21-0.25	0.19-0.22	0.17-0.20	0.15-0.19	050	0.50-0.62
0.62-0.75	0.36-0.45	0.33-0.36	0.28-0.31	0.25-0.29	0.22-0.26	0.20-0.23	0.19-0.22	062	0.62-0.75
0.75-1.00	0.45-0.60	0.36-0.49	0.31-0.42	0.29-0.38	0.26-0.34	0.23-0.31	0.22-0.31	075	0.75-1.00
1.00-1.25	0.60-0.76	0.49-0.63	0.42-0.54	0.38-0.48	0.34-0.43	0.31-0.39	0.29-0.36	100	1.00-1.25
1.25-1.50	0.76-0.91	0.63-0.76	0.54-0.65	0.48-0.58	0.43-0.52	0.39-0.46	0.36-0.43	125	1.25-1.50
1.50-1.75	0.91-1.08	0.76-0.89	0.65-0.77	0.58-0.67	0.52-0.60	0.46-0.54	0.43-0.49	150	1.50-1.75
1.75-2.00	1.08-1.23	0.89-1.02	0.77-0.88	0.67-0.77	0.60-0.69	0.54-0.62	0.49-0.57	175	1.75-2.00
2.00-2.50	1.23-1.54	1.02-1.28	0.88-1.10	0.77-0.96	0.69-0.86	0.62-0.77	0.57-0.72	200	2.00-2.50
2.50-3.00	1.54-1.84	1.28-1.53	1.10-1.32	0.96-1.16	0.86-1.03	0.77-0.93	0.72-0.86	250	2.50-3.00
3.00-3.50	1.84-2.15	1.53-1.79	1.32-1.54	1.16-1.35	1.03-1.20	0.93-1.08	0.86-1.00	300	3.00-3.50
3.50-4.00	2.15-2.45	1.79-2.05	1.54-1.76	1.35-1.54	1.20-1.37	1.08-1.24	1.00-1.14	350	3.50-4.00

Cable Diameters in Fractional Inches

1 Cable	2 Cables	3 Cables	4 Cables	5 Cables	6 & 7 Cables	8 Cables	9 Cables	Cat. No. Size Code	Grip Diam. Range
1/4-3/8	1/64-1/4	5/32-7/32	1/8-13/64	7/64-9/64	3/32-7/64	3/32-7/64	1/16-3/32	025	1/8-3/8
3/8-1/2	1/4-23/64	7/32-21/64	13/64-9/32	9/64-1/4	7/64-1/4	7/64-13/64	3/32-3/16	037	3/8-1/2
5/8-3/4	23/64-29/64	21/64-23/64	9/32-5/16	1/4-19/64	7/32-17/64	13/64-15/64	3/16-7/32	050	1/2-5/8
1/2-5/8	17/64-23/64	7/64-21/64	15/64-9/32	7/32-1/4	3/16-7/32	11/64-13/64	5/32-3/16	062	5/8-3/4
3/4-1	29/64-39/64	23/64-31/64	5/16-27/64	19/64-3/8	17/64-11/32	15/64-5/16	7/32-5/16	075	3/4-1
1-1-1/4	39/64-49/64	31/64-5/8	27/64-35/64	3/8-31/64	11/32-7/16	5/16-25/64	19/64-23/64	100	1-1-1/4
1-1/4-1-1/2	49/64-29/32	5/8-49/64	35/64-21/32	31/64-37/64	7/16-33/64	25/64-15/32	23/64-7/16	125	1-1/4-1-1/2
1-1/2-1-3/4	29/32-1-5/64	49/64-57/64	21/32-49/64	37/64-43/64	33/64-39/64	15/32-35/64	7/16-31/64	150	1-1/2-1-3/4
1-3/4-2	1-5/64-1-15/64	57/64-1-1/64	49/64-7/8	43/64-49/64	39/64-11/16	35/64-5/8	31/64-37/64	175	1-3/4-2
2-2-1/2	1-15/64-1-35/64	1-1/64-1-9/32	7/8-1-3/32	49/64-31/32	11/16-55/64	5/8-49/64	37/64-23/32	200	2-2-1/2
2-1/2-3	1-35/64-1-27/32	1-9/32-1-17/32	1-3/32-1-21/64	31/32-1-5/32	55/64-1-1/32	49/64-15/16	23/32-55/64	250	2-1/2-3
3-3-1/2	1-27/32-2-5/32	1-17/32-1-51/64	1-21/64-1-35/64	1-5/32-1-23/64	1-1/32-1-13/64	15/16-1-5/64	55/64-1	300	3-3-1/2
3-1/2-4	2-5/32-2-29/64	1-51/64-2-3/64	1-35/64-1-49/64	1-23/64-1-35/64	1-13/64-1-3/8	1-5/64-1-15/64	1-1-9/64	350	3-1/2-4



Wire-Mesh Grips

Table 2

Pulling-Grip Selection Table for Cables of Different Diameters to Be Pulled in One Grip

Grip Circumference Range		Cat. No. Size Code	Grip Diameter Range	
Fractional Inches	Decimal Inches		Fractional Inches	Decimal Inches
25/32-1-11/64	.78-1.17	025	1/8-3/8	.12-.37
1-11/64-1-37/64	1.17-1.57	037	3/8-1/2	.37-.50
1-37/64-1-15/16	1.57-1.94	062	1/2-5/8	.50-.62
1-37/64-2-3/8	1.57-2.37	050	5/8-3/4	.62-.75
2-3/8-3-5/32	2.37-3.15	075	3/4-1	.75-1.00
3-5/32-3-15/16	3.15-3.94	100	1-1-1/4	1.00-1.25
3-15/16-4-23/32	3.94-4.72	125	1-1/4-1-1/2	1.25-1.50
4-23/32-5-33/64	4.72-5.51	150	1-1/2-1-3/4	1.50-1.75
5-33/64-6-19/64	5.51-6.29	175	1-3/4-2	1.75-2.00
6-19/64-7-55/64	6.29-7.86	200	2-2-1/2	2.00-2.50
7-55/64-9-7/16	7.86-9.43	250	2-1/2-3	2.50-3.00
9-7/16-11-1/64	9.43-11.01	300	3-3-1/2	3.00-3.50
11-1/64-12-37/64	11.01-12.58	350	3-1/2-4	3.50-4.00

"Grip Circumference Range" refers to circumference of all cables held together.

1. Determine grip circumference range by measuring circumference of bundle of cables to be held.
2. Read down to locate correct range.
3. Read across for catalog number size code.

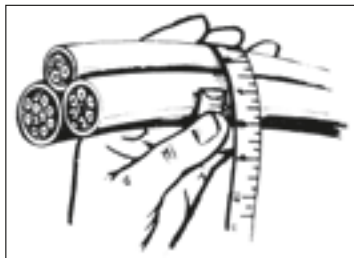

Example:

For four cables together with circumference of 6.35", use grip containing catalog number size code "200".

Table 4

Reference Table: AWG Wire Sizes

For your convenience, the following are representative portable cord diameters.

AWG Wire Size & Type	Conductors							
	2		3		4		5	
	①	②	①	②	①	②	①	②
18 SO, STO	3.90	.390	.410	.405	.440	.435	.500	.495
18 SJO, SJTO	.310	.300	.330	.330	.360	.360	-	-
16 SO, STO	.410	.405	.430	.430	.490	.485	.530	.525
16 SJO, SJTO	.330	.330	.340	.360	.390	.390	-	-
14 SO, STO	.530	.530	.560	.560	.610	.605	.680	.685
12 SO, STO	.610	.605	.640	.640	.680	.670	.750	.730
10 SO, STO	.650	.640	.690	.695	.750	.820	.815	-
8 SO, STO	.810	.810	.910	.910	.990	.990	1.080	1.080
6 SO, STO	.930	.930	1.010	1.010	1.100	1.100	1.200	1.200

Table 3

Reference Table: Dimension Conversions for Ordering Tables

Decimal Inches	Fractional Inches	Metric Dimensions (mm)
0.12-0.24	1/8-15/64	3.17-5.95
0.25-0.36	1/4-23/64	6.35-9.13
0.37-0.49	3/8-31/64	9.52-12.30
0.50-0.61	1/2-39/64	12.70-15.48
0.62-0.74	5/8-47/64	15.88-18.65
0.75-0.99	3/4-63/64	19.05-25.00
1.00-1.24	1-1-15/64	25.40-31.35
1.25-1.49	1-1/4-1-31/64	31.75-37.70
1.50-1.99	1-1/2-1-63/64	38.10-50.40
2.00-2.49	2-2-31/64	50.80-63.10
2.50-2.99	2-1/2-2-63/64	63.50-75.80
3.00-3.49	3-3-31/64	76.20-88.50
3.50-3.99	3-1/2-3-63/64	88.90-101.20

Table 5

Reference Table: AWG or MCM Wire Sizes

This table is to be used as a guide only. Sizes may vary by manufacturer.

AWG OR MCM	Diameter	
	TTHN	THW
14	.105	.162
12	.122	.179
10	.153	.199
8	.201	.259
6	.257	.323
4	.328	.372
3	.356	.401
2	.388	.433
1	.450	.508
1/0	.491	.549
2/0	.537	.595
3/0	.588	.647
4/0	.646	.705
250	.716	.788
300	.771	.843
350	.822	.895
400	.869	.942
500	.955	1.03
600	-	1.12
700	-	1.19
750	-	1.22
1000	-	1.38



Wire-Mesh Grips

Single-Weave, Flexible-Eye Pulling Grips



KPJ-50

Cable Dia. *	KPJ Junior Duty				KPL Light Duty			
	Cat. No.	Loaded/Compressed Mesh Length	Maximum Safe Load	Weight	Short Length			
	Cat. No.	Loaded/Compressed Mesh Length	Maximum Safe Load	Weight	Cat. No.	Loaded/Compressed Mesh Length	Maximum Safe Load	Weight
.50"-.61"	KPJ-50	8.5"	260 lbs. (118 kg)	.05 lbs.	—	—	—	—
.75"-.99"	KPJ-75	10"	560 lbs. (254 kg)	.10 lbs.	—	—	—	—
1.00"-1.24"	KPJ-100	11.5"	780 lbs. (354 kg)	.28 lbs.	—	—	—	—
1.25"-1.49"	—	—	—	—	KPL-125-1	14"	1060 lbs. (481 kg)	.40 lbs.
1.50"-1.74"	—	—	—	—	KPL-150-1	15"	1360 lbs. (617 kg)	.40 lbs.
2.00"-2.49"	—	—	—	—	KPL-200-1	18"	1700 lbs. (771 kg)	.65 lbs.

*For equivalent cable diameters in fractional inches and in metric dimensions (mm), see Dimensions Conversion Reference Table 3.

Double-Weave, Flexible-Eye Pulling Grips

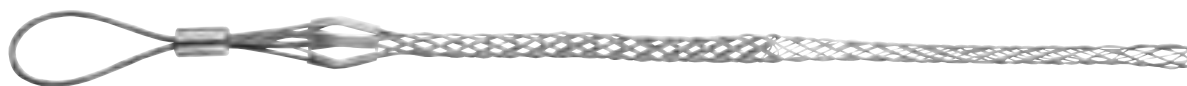

KPM-075

Cable Dia. *	KPM Medium Duty				KP Heavy Duty							
	Cat. No.	Loaded/Compressed Mesh Length	Maximum Safe Load	Weight	Short Length				Medium Length			
	Cat. No.	Loaded/Compressed Mesh Length	Maximum Safe Load	Weight	Cat. No.	Loaded/Compressed Mesh Length	Maximum Safe Load	Weight	Cat. No.	Loaded/Compressed Mesh Length	Maximum Safe Load	Weight
.50"-.61"	KPM-050	13"	480 lbs. (218 kg)	.10 lbs.	—	—	—	—	—	—	—	—
.75"-.99"	KPM-075	16"	1030 lbs. (467 kg)	.20 lbs.	KP-075-24	24"	1360 lbs. (617 kg)	.50 lbs.	KP-075-36	36"	1360 lbs. (617 kg)	.74 lbs.
1.00"-1.37"	KPM-100	18"	1420 lbs. (644 kg)	.40 lbs.	—	—	—	—	—	—	—	—
1.00"-1.49"	—	—	—	—	KP-100-24	24"	1920 lbs. (871 kg)	1.1 lbs.	KP-100-36	36"	1920 lbs. (871 kg)	1.0 lbs.
1.50"-1.99"	—	—	—	—	—	—	—	—	KP-150-36	36"	3280 lbs. (1488 kg)	1.6 lbs.

*For equivalent cable diameters in fractional inches and in metric dimensions (mm), see Dimensions Conversion Reference Table 3.

▲WARNING: Do NOT exceed maximum safe load as listed on the label attached to the product.

▲WARNING: Do NOT use on live circuits.

▲WARNING: Always match proper size and type of grip to application.

▲WARNING: Always inspect equipment before use.



Wire-Mesh Grips

Double-Weave, Rotating-Eye Pulling Grips



KPS-062-1

Cable Dia. *	KPS Heavy Duty							
	Medium Length				Medium-Long Length			
	Cat. No.	Loaded/Compressed Mesh Length	Maximum Safe Load	Weight	Cat. No.	Loaded/Compressed Mesh Length	Maximum Safe Load	Weight
.50"-.61"	KPS-050-2	16"	1120 (508 kg)	.45 lbs.	—	—	—	—
.62"-.74"	KPS-062-2	16"	1360 (617 kg)	.50 lbs.	—	—	—	—
.75"-.99"	KPS-075-2	20"	1360 (617 kg)	.85 lbs.	—	—	—	—
1.00"-1.24"	KPS-100-2	20"	2560 (1161 kg)	1.9 lbs.	—	—	—	—
1.00"-1.49"	—	—	—	—	KPS-100-3	33"	3280 (1488 kg)	2.4 lbs.
1.25"-1.49"	KPS-125-2	21"	2560 (1161 kg)	1.9 lbs.	—	—	—	—
1.50"-1.99"	KPS-150-2	25"	3280 (1488 kg)	2.2 lbs.	KPS-150-3	34"	3280 (1488 kg)	2.5 lbs.
2.00"-2.49"	KPS-200-2	26"	5440 (2468 kg)	4.1 lbs.	KPS-200-3	36"	5440 (2468 kg)	4.7 lbs.
2.50"-2.99"	KPS-250-2	28"	6600 (2994 kg)	5.3 lbs.	—	—	—	—
3.00"-3.49"	KPS-300-2	30"	8200 (3720 kg)	6.1 lbs.	—	—	—	—
3.50"-3.99"	KPS-350-2	32"	9600 (4355 kg)	6.8 lbs.	—	—	—	—

*For equivalent cable diameters in fractional inches and in metric dimensions (mm), see Dimensions Conversion Reference Table 3.

Slack-Pulling, Offset Flexible-Eye Pulling Grips



KSCK-100-1

Cable Dia. *	KSCK Medium Duty – Standard Length				KSSK Medium Duty – Standard Length			
	Cat. No.	Loaded/Compressed Mesh Length	Maximum Safe Load	Weight	Cat. No.	Loaded/Compressed Mesh Length	Maximum Safe Load	Weight
.75"-.99"	—	—	—	—	KSSK-075-1	12"	500 lbs. (227 kg)	.30 lbs.
1.00"-1.24"	KSCK-100-1	15"	800 lbs. (363 kg)	.50 lbs.	KSSK-100-1	15"	700 lbs. (318 kg)	.25 lbs.
1.25"-1.49"	—	—	—	—	KSSK-125-1	16"	800 lbs. (363 kg)	.25 lbs.

*For equivalent cable diameters in fractional inches and in metric dimensions (mm), see Dimensions Conversion Reference Table 3.



⚠WARNING: Do NOT exceed maximum safe load as listed on the label attached to the product.

⚠WARNING: Do NOT use on live circuits.

⚠WARNING: Always match proper size and type of grip to application.

⚠WARNING: Always inspect equipment before use.

Steel Construction Tools

Klein has combined unique design features with skillful engineering and manufacturing to create a superior line of steel construction tools. These tools are exceptionally rugged, with a long usage life.

F O R P R O F E S S I O N A L S . . . S I N C E 1 8 5 7 ®



Steel Construction Tools



Construction Tools

Tie-Wire Reel

- Rugged, lightweight reel is smooth aluminum alloy with wear parts made of steel.
- Feeds pre-coiled wire smoothly, easily and quickly to save time and reduce wasted wire.
- Designed for left- or right-hand use.
- Large, comfortable rewind knob.
- Easily-removed cover plate that permits quick, convenient reloading to handle all types of wire.



27400

Cat. No.	Diameter	Width	Weight (lbs.)
27400	6-1/4" (159 mm)	2-25/32" (71 mm)	2.35

Tie-Wire Accessories

- Strong double-tongue buckle with keeper.
- Has separate reel-strap with its own buckle that lets you quickly and conveniently put on or take off a Klein tie-wire reel and optional pad without removing the belt or your tool pouch.
- Leather construction.
- Heavy-Duty Tie-Wire Belts.



5420L

Cat. No.	Waist Size	Belt Size Range	Width	Weight (lbs.)
5420S	36" (914 mm)	32" - 40" (813 mm - 1016 mm)	2" (51 mm)	.85
5420	40" (1016 mm)	36" - 44" (914 mm - 1118 mm)	2" (51 mm)	.95
5420L	44" (1118 mm)	40" - 48" (1016 mm - 1219 mm)	2" (51 mm)	1.05
5420XL	48" (1219 mm)	44" - 52" (1118 mm - 1321 mm)	2" (51 mm)	1.15

- Tie-Wire Reel Pad.

Cat. No.	Length	Width	Weight (lbs.)
27450	7" (178 mm)	7" (178 mm)	.300



27450

For more accessories information, see Tool Pouches, Carriers, Belts & Suspenders section

Rebar Hickeys

- Lightweight rebar hickey has exceptionally durable steel-alloy head and extra-strong handle to withstand extreme conditions.



64310

Cat. No.	Hickey Size	Bends Rebar Size	Head Type and Bending Angle	Handle Length	Weight (lbs.)
64309	1a	nos. 3 (.375" dia.), 4 (.500" dia.)	double 65° and 90°	24" (610 mm)	3.50
64310	2	no. 5 (.625" dia.)	single 65°	40" (1016 mm)	7.50
64311	3	no. 6 (.750" dia.)	single 65°	40" (1016 mm)	8.00
64312	4	nos. 7 (.875" dia.), 8 (1.00" dia.), 9 (1.128" dia.)	single 65°	60" (1524 mm)	16.40

Grizzly® Bar



64306

- A heavy, strong, multi-purpose tool that saves time and effort on the job.
- The 3" (76 mm) width protects concrete when stripping forms.
- Efficient blade angle and 55-1/2" (141 cm) total length provide high leverage as a crow bar, as well as a nail and spike puller.
- Blade is forged and hardened alloy with keyhole nail-pulling slot in center and "V" notch in tapered edge.
- Very efficient nail-pulling tool even in awkward positions.
- Can be used to help align walls during tilt-up construction, to roll and align large pipe, to remove shingles and flooring, and for many other stripping and prying tasks.

Cat. No.	Overall Length	Weight (lbs.)
64306	55-1/2" (1410 mm)	12.00

All dimensions are in inches and (millimeters).

For additional construction tools, see Mining Tools section

⚠WARNING: Always wear approved personal protective equipment.

⚠WARNING: Always wear approved eye protection.

⚠WARNING: Do NOT exceed rated capacity for rebar shear and rebar hiccys.

Connecting Bars

Hex Bars



- Provides extra leverage when positioning steel members and aligning bolt holes.
- Forged fit-up bar is pointed on one end.
- Chisel-end is at a 15° angle to give greater leverage.

3242

Cat. No.	Hex Diameter	Length	Weight (lbs.)
3242	3/4" (19 mm)	30" (762 mm)	3.50
3243	7/8" (22 mm)	36" (914 mm)	6.00
3244	3/4" (19 mm)	24" (610 mm)	2.50

Cat. No.	Hex Diameter	Length	Weight (lbs.)
Straight Chisel-End			
3240	3/4" (19 mm)	30" (762 mm)	3.80

Round Bars



- Provides extra leverage when positioning steel members and aligning bolt holes.
- Forged fit-up bar is pointed on one end.
- Chisel-end is at a 15° angle to give even greater leverage.

3245

Cat. No.	Diameter	Length	Weight (lbs.)
3245	3/4" (19 mm)	30" (762 mm)	3.30
3246	7/8" (22 mm)	36" (914 mm)	5.50
3247	3/4" (19 mm)	24" (610 mm)	2.50

Cat. No.	Diameter	Length	Weight (lbs.)
3248	7/8" (22 mm)	30" (762 mm)	4.30
Straight Chisel-End			
3241	3/4" (19 mm)	30" (762 mm)	3.20

Pins

Standard Bull Pins

- Machined from quality alloy steel.
- Heat-treated for strength, black finish for rust resistance.



3252

Cat. No.	Top Diameter	Point Diameter	Length	Weight (lbs.)
3251	1-1/16" (27 mm)	3/8" (10 mm)	15" (381 mm)	2.50
3252	1-3/16" (30 mm)	7/16" (11 mm)	15" (381 mm)	3.10
3257	1-1/16" (27 mm)	3/8" (10 mm)	12" (305 mm)	1.70

Cat. No.	Top Diameter	Point Diameter	Length	Weight (lbs.)
3258	1-3/16" (30 mm)	7/16" (11 mm)	12" (305 mm)	2.10
3259	1-5/16" (33 mm)	7/16" (11 mm)	12" (305 mm)	2.50
3265	1-1/4" (32 mm)	7/16" (11 mm)	12" (305 mm)	2.50

Note: OSHA 1926.301 (c) specifically states: "Impact tools, such as drift pins, wedges and chisels, shall be kept free of mushroomed heads."

Broad Head Bull Pins

- Forged, heat-treated bull pin increases efficiency by providing a larger striking surface.
- Angled head and smooth blending of radii increase strength and reduce the danger of chipping.
- Below the head, squared-off shoulders have been forged to provide a surface for applying wrench to loosen wedged bull pins.
- Long, even taper reduces binding and hang-up.
- Added resistance to "mushrooming" permitting much longer use than is possible with conventional designs.



3255

Cat. No.	Top Diameter	Point Diameter	Length	Weight (lbs.)
3255	1-1/4" (32 mm)	5/16" (8 mm)	13-3/4" (349 mm)	2.90
3256	1-1/16" (27 mm)	1/4" (6 mm)	10" (254 mm)	1.60

Note: OSHA 1926.301 (c) specifically states: "Impact tools, such as drift pins, wedges and chisels, shall be kept free of mushroomed heads."

Barrel-Type Drift Pins

- Machined from quality alloy steel.
- Tapers are uniform and blend into body diameter.
- Tough, drop-forged steel will properly end-pein in use.
- Heat-treated for strength.
- Black finish for rust resistance.



3261

Cat. No.	Maximum Diameter	Point Diameter	Overall Length	Weight (lbs.)
3260	1 1/16" (18 mm)	5/16" (8 mm)	7-1/2" (191 mm)	.60
3261	1 3/16" (21 mm)	7/16" (11 mm)	8" (203 mm)	.85
3262	1 5/16" (24 mm)	1/2" (13 mm)	8" (203 mm)	1.10
3263	1-1/16" (27 mm)	9/16" (14 mm)	8" (203 mm)	1.50

All dimensions are in inches and (millimeters).

For additional construction tools, see Mining Tools section

▲WARNING: Always wear approved eye protection.



Construction Wrenches

Adjustable-Head Construction Wrenches

- Eliminates the need to carry several fixed-size wrenches.
- Forged from select alloy steel with continuous-taper handle.
- Industrial black finish for corrosion resistance.
- Lanyard hole for easy tool tethering.



Cat. No.	Max. Size Capacity	Length	Weight (lbs.)
3239	1-1/2" (38 mm)	16" (406 mm)	2.30
3227	1-5/16" (33 mm)	11" (279 mm)	1.20

1/2"- Drive Ratcheting Construction Wrench

- Accepts 1/2" square-drive hex socket.
- Reversible ratchet.
- Eliminates the need for carrying several fixed-size wrenches.
- Forged from select alloy steel with continuous-taper handle for aligning bolt and/or rivet holes.
- Industrial black finish for corrosion resistance.



Cat. No.	Overall Length	Weight (lbs.)
3238	15" (381 mm)	2.10

Erection Wrenches

- Forged from select alloy steel to withstand high-leverage and heavy loads.
- Extra-heavy-duty head area gives maximum strength and durability.
- Continuous taper of handle makes lining-up bolt holes easy and works on a range of bolt-hole sizes without binding.
- Extra-large hub area works on larger diameter holes better than other wrenches.
- Catalog number, bolt size and nominal opening size are stamped on every wrench for easy identification.
- American Bridge design.



Cat. No.	Nut Type	Bolt Size	Nom. Opening	Head Width	Taper Diameter	Overall Length	Weight (lbs.)
3210	U.S. heavy	1/2"	7/8"	2-1/4"	7/8" to 3/16"	14-3/4"	1.36
3211	U.S. heavy	5/8"	1-1/16"	2-1/4"	7/8" to 3/16"	14-3/4"	1.31
3212	U.S. heavy	3/4"	1-1/4"	2-1/2"	1" to 1/4"	16-5/8"	1.98
3213	U.S. heavy	7/8"	1-7/16"	3"	1-1/8" to 9/32"	17-3/8"	2.72
3214	U.S. heavy	1"	1-5/8"	3-5/8"	1-1/8" to 1/4"	18"	3.36
3219	U.S. regular	1/2"	3/4"	2-1/4"	7/8" to 8/16"	14-3/4"	1.36
3220	U.S. regular	1/2"	13/16"	2-1/4"	7/8" to 3/16"	14-3/4"	1.35
3221	U.S. regular	5/8"	1"	2-1/4"	7/8" to 3/16"	14-3/4"	1.31
3222	U.S. regular	3/4"	1-1/8"	2-1/2"	1" to 1/4"	16-5/8"	2.00
3223	U.S. regular	7/8"	1-5/16"	3"	1-1/8" to 9/32"	17-3/8"	2.87
3224	U.S. regular	1"	1-1/2"	3-5/8"	1-1/8" to 1/4"	18"	3.37
3231	utility	5/8"	15/16"	2-1/4"	7/8" to 3/16"	14-3/4"	1.31
3232	utility	3/4"	1-1/16"	2-1/2"	1" to 1/4"	16-5/8"	2.00

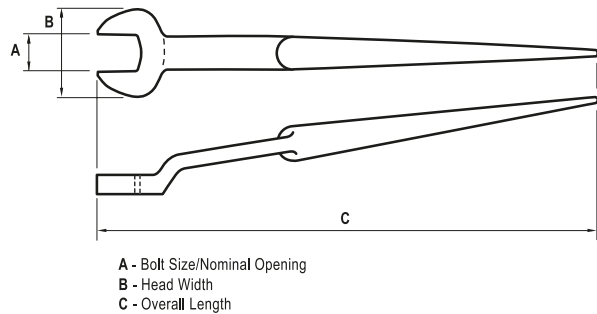

For additional construction tools, see Mining Tools section

All dimensions are in inches and (millimeters).

⚠WARNING: Always wear approved eye protection.

⚠WARNING: Do NOT push or hammer wrench.

⚠WARNING: Do NOT extend handle length.



Mining & Heavy Industry Tools

The Mumme Products' range of forged hand tools are produced to the highest possible standards for use in the mining and heavy construction industries. With top quality materials and safety as a priority, we design and manufacture superior products available worldwide.

F O R P R O F E S S I O N A L S S I N C E 1 8 5 7 ®



Mining & Heavy Industry Tools



Bars – Construction



Crowbars – Hexagon (St. Angelo Bars)



- Used for digging holes and breaking clay, rock and concrete.
- Forged from tough high-tensile carbon manganese steel.
- Ground and sharpened to a diamond point for easier digging and breaking concrete.
- Long tapered blade also for easier digging.
- Both ends heat treated for increased performance and strength.
- Hexagon bar profile for greater control.
- Anti-corrosive primer with enamel finish.
- Precision heat treated to best suit product application.

5CB180025



Cat No	Blade Width	Hexagon Diameter	Length	Weight
5CB150025	2" (50 mm)	1" (25 mm)	59" (1500 mm)	13.49 lbs. (6.12 kg)
5CB150030	2" (50 mm)	1-3/16" (30 mm)	59" (1500 mm)	18.95 lbs. (8.60 kg)
5CB165025	2" (50 mm)	1" (25 mm)	65" (1650 mm)	14.77 lbs. (6.70 kg)
5CB165030	2" (50 mm)	1-3/16" (30 mm)	65" (1650 mm)	20.94 lbs. (9.50 kg)
5CB180025	2" (50 mm)	1" (25 mm)	71" (1800 mm)	16.20 lbs. (7.35 kg)
5CB180030	2" (50 mm)	1-3/16" (30 mm)	71" (1800 mm)	23.03 lbs. (10.45 kg)

Crowbars – Round (St. Angelo Bars)



- Used for digging holes and breaking clay, rock and concrete.
- Forged from tough high-tensile carbon manganese steel.
- Ground and sharpened to a diamond point for easier digging and breaking concrete.
- Long, tapered blade also for easier digging.
- Both ends heat treated for increased performance and strength.
- Round bar profile easier on hands.
- Anti-corrosive primer with enamel finish.
- Precision heat treated to best suit product application.

5CBR180030

Cat. No.	Blade Width	Diameter	Length	Weight
5CBR180022	1-1/2" (38 mm)	7/8" (22 mm)	71" (1800 mm)	12.12 lbs. (5.50 kg)
5CBR180025	2" (50 mm)	1-1/16" (27 mm)	71" (1800 mm)	17.08 lbs. (7.75 kg)
5CBR180030	2" (50 mm)	1-3/16" (30 mm)	71" (1800 mm)	21.38 lbs. (9.70 kg)

Gooseneck Bar – Hexagon



- Used for levering and moving objects into place with a lift and swivel motion.
- Forged from tough high-tensile carbon manganese steel.
- Diamond point and gooseneck ends for flexibility of use.
- Gooseneck set for improved leverage.
- Hexagon bar profile for greater control.
- Precision heat treated to best suit product application.

5GNB180030

Cat. No.	Hexagon Diameter	Length	Weight
5GNB180030	1-3/16" (30 mm)	71" (1800 mm)	24.74 lbs. (11.10 kg)

All dimensions are in inches and (millimeters).

⚠WARNING: Always ensure that you and persons in the vicinity wear approved eye protection and gloves.

Bars – Construction



Slate Bars – Hexagon (Pinch Bars)



5PB180025

- Used for levering and moving objects into place with a lift and swivel motion.
- Forged from high-tensile carbon manganese steel for maximum strength.
- Heel offset to 40° angle for optimum lifting.
- Hexagon bar profile gives greater control and reduces bar roll.
- Heat-treated blade ends for maximum toughness.
- Precision heat treated to best suit product application.



Cat. No.	Hexagon Diameter	Length	Weight
5PB150025	1" (25 mm)	59" (1500 mm)	13.55 lbs. (6.15 kg)
5PB150030	1-3/16" (30 mm)	59" (1500 mm)	19.62 lbs. (8.90 kg)
5PB165025	1" (25 mm)	65" (1650 mm)	15.01 lbs. (6.81 kg)
5PB165030	1-3/16" (30 mm)	65" (1650 mm)	21.91 lbs. (9.94 kg)
5PB180025	1" (25 mm)	71" (1800 mm)	16.82 lbs. (7.63 kg)
5PB180030	1-3/16" (30 mm)	71" (1800 mm)	24.31 lbs. (11.02 kg)
5PB45016	5/8" (16 mm)	18" (450 mm)	1.58 lbs. (0.72 kg)
5PB60020	25/32" (20 mm)	24" (600 mm)	3.37 lbs. (1.53 kg)
5PB60025	1" (25 mm)	24" (600 mm)	5.31 lbs. (2.41 kg)
5PB75025	1" (25 mm)	30" (750 mm)	6.70 lbs. (3.04 kg)
5PB90025	1" (25 mm)	36" (900 mm)	8.04 lbs. (3.65 kg)

Scaling Bars – Tubular Aluminum (Aluminium) – Hexagon



7SCTH1800

- Used in the mining industry for prying overhanging rock.
- Aluminium tube body for light weight and less user fatigue.
- Inserted steel ends forged from tough carbon manganese steel.
- Heel offset to 40° angle for optimum levering.
- Precision heat treated to best suit product application.
- Hexagon shape for increased control.



Cat. No.	Hexagon Diameter	Length	Weight
7SCTH1800	1-1/4" (32 mm)	71" (1800 mm)	6.54 lbs. (2.97 kg)
7SCTH2400	1-1/4" (32 mm)	94-1/2" (2400 mm)	7.51 lbs. (3.41 kg)

Scaling Bars – Tubular Aluminum (Aluminium) – Round



7SCT4320

- Used in the mining industry for prying overhanging rock.
- Aluminium tube body for light weight and less user fatigue.
- Inserted steel ends forged from tough carbon manganese steel.
- Heel offset to 40° angle for optimum levering.
- Precision heat treated to best suit product application.



Cat. No.	Diameter	Length	Weight
7SCT1800	1-1/4" (32 mm)	71" (1800 mm)	6.37 lbs. (2.89 kg)
7SCT3660	1-1/4" (32 mm)	144" (3660 mm)	9.25 lbs. (4.20 kg)
7SCT4320	1-1/4" (32 mm)	170" (4320 mm)	10.20 lbs. (4.63 kg)

All dimensions are in inches and (millimeters).

⚠ WARNING: Always ensure that you and persons in the vicinity wear approved eye protection and gloves.



Bars – Mining



Scaling Bars – Chrome Alloy Steel – Hexagon



- Used in the mining industry for prying overhanging rock.
- Forged from chrome alloy steel.
- Heat-treated blades for maximum toughness.
- Hex profile for good control.
- Heel offset to 40° angle for optimum levering.
- Precision heat treated to best suit product application.

7SC150019



Cat. No.	Hexagon Diameter	Length	Weight
7SC120019	25/32" (20 mm)	47" (1200 mm)	6.87 lbs. (3.12 kg)
7SC150019	25/32" (20 mm)	59" (1500 mm)	8.62 lbs. (3.91 kg)
7SC180019	25/32" (20 mm)	71" (1800 mm)	10.31 lbs. (4.68 kg)
7SC210019	25/32" (20 mm)	83" (2100 mm)	12.01 lbs. (5.45 kg)
7SC240019	25/32" (20 mm)	94-1/2" (2400 mm)	13.75 lbs. (6.24 kg)

Chisels & Punches

Cold Chisels – Alloy Cross Cut

- Used for removing oil seals.
- Also used for cutting in corners and difficult or confined areas.
- Forged from chrome alloy steel to give a harder blade with great resilience.
- Precision hardened and tempered so blade will not shatter when struck hard.
- Accurately ground to the optimum angle for cutting.



7CHC15013

Cat. No.	Blade Width	Overall Length	Weight
7CHC15013	1/4" (6.5 mm)	6" (150 mm)	0.26 lbs. (0.12 kg)
7CHC17516	5/16" (8 mm)	7" (175 mm)	0.50 lbs. (0.23 kg)
7CHC20020	3/8" (10 mm)	8" (200 mm)	0.55 lbs. (0.25 kg)

Brass Punches

- Used where a softer punch is needed, e.g. where damage may occur from using a hardened punch.
- Selected brass, correct composition for punch use.
- Knurled handle for gripping easily.
- Chamfered head for safety.



4BP16

Cat. No.	Diameter	Overall Length	Weight
4BP10	3/8" (10 mm)	6" (150 mm)	0.22 lbs. (0.10 kg)
4BP12	1/2" (12 mm)	7" (175 mm)	0.30 lbs. (0.14 kg)
4BP16	5/8" (16 mm)	7" (175 mm)	0.66 lbs. (0.30 kg)
4BP19	3/4" (19 mm)	8" (200 mm)	1.05 lbs. (0.48 kg)
4BP25	1" (25 mm)	8" (200 mm)	1.87 lbs. (0.85 kg)
4BPSET5	3/8", 1/2", 5/8", 3/4", 1" (10 mm, 12 mm, 16 mm, 19 mm, 25 mm)	6", 7", 8", 8" (150 mm, 175 mm, 175 mm, 200 mm, 200 mm)	4.38 lbs. (1.99 kg)
7BP29219	3/4" (19 mm)	11-1/2" (292 mm)	1.54 lbs. (0.70 kg)
7BP29225	1" (25 mm)	11-1/2" (292 mm)	2.75 lbs. (1.25 kg)
7BP29232	1-1/4" (32 mm)	11-1/2" (292 mm)	4.32 lbs. (1.96 kg)

All dimensions are in inches and (millimeters).

⚠WARNING: Always ensure that you and persons in the vicinity wear approved eye protection and gloves.

Construction Tools



Barrel Drifts

- Used for aligning holes in construction.
- Also used for expanding holes in mild steel.
- Forged from tough high-tensile steel.
- Taper is forged, not turned, for finer grain, giving greater tensile strength.
- Will not score edge when driven hard.
- Precision heat treated to best suit product application.



5BD24

Cat. No.	Point Diameter (approx.)	Diameter	Overall Length	Weight
5BD30	37/64" (14.5 mm)	1-3/16" (30 mm)	7-7/8" (200 mm)	1.76 lbs. (0.80 kg)
5BD33	5/8" (16 mm)	1-19/64" (33 mm)	7-7/8" (200 mm)	2.29 lbs. (1.04 kg)

Podger Pins (Broad Head Bull Pins)



5POP25

- Used for aligning holes and expanding holes in mild steel.
- Forged from tough high-tensile carbon manganese steel.
- Forged, not turned, long tapered point for ease of aligning.
- For added safety, forged head prevents pin being driven right through hole and falling.
- Hex shaft allows spanner to be used to assist removal.
- Can be carried on belt.
- Precision heat treated to best suit product application.

Cat. No.	Point	Diameter Across Hexagon Points	Hexagon Shaft Diameter	Overall Length	Weight
5POP25	1/2" (12 mm)	1-3/32" (28 mm)	1" (25 mm)	16" (400 mm)	3.26 lbs. (1.48 kg)
5POP30	9/16" (14.5 mm)	1-5/16" (33.5 mm)	1-3/16" (30 mm)	16" (400 mm)	4.49 lbs. (2.04 kg)

Fox Wedge – Stainless Steel

- Used for splitting mating surfaces and for packing machinery and structures before fixing.
- Also used in the marine environment because of its corrosion-resistant properties.
- Forged from stainless steel for greater hardness and non-magnetic properties.
- Ground blade with fine edge for easy entry.
- Precision heat treated to best suit product application.



7FWSS10025

Cat. No.	Width	Thickness	Overall Length	Weight
7FWSS10025	1" (25 mm)	5/16" (8 mm)	4" (100 mm)	0.22 lbs (0.10 kg)

All dimensions are in inches and (millimeters).

⚠WARNING: Always ensure that you and persons in the vicinity wear approved eye protection and gloves.



Construction Tools



Pry Bar



5PRBP45016

- Used for prying, separating flanges and aligning holes.
- Forged from tough high-tensile carbon manganese steel.
- Thin, finely ground curved chisel end for ease of entry between surfaces.
- Forged, not turned, long tapered point for maximum strength.
- Hexagon profile for greater control.
- Precision heat treated to best suit product application.

Cat. No.	Chisel Width	Hexagon Diameter	Overall Length	Weight
5PRBP45016	25/32" (20 mm)	5/8" (16 mm)	18" (450 mm)	1.67 lbs. (0.76 kg)

Pinch Bars – Hexagon (Podger Bars)



5POB37520

- Used for levering and aligning.
- Forged from tough high-tensile carbon manganese steel.
- Heel set to 40° angle for optimum levering; blade ground to 30° angle for easy entry between surfaces.
- Taper is forged, not turned, for finer grain, giving greater tensile strength.
- Hexagon profile for greater control and to minimize bar roll.
- Precision heat treated to best suit product application.

Cat. No.	Point Diameter	Hexagon Diameter	Overall Length	Weight
5POB37516	5/16" (8 mm)	5/8" (16 mm)	15" (375 mm)	1.21 lbs. (0.55 kg)
5POB37520	3/8" (10 mm)	25/32" (20 mm)	15" (375 mm)	1.82 lbs. (0.83 kg)
5POB45016	5/16" (8 mm)	5/8" (16 mm)	18" (450 mm)	1.49 lbs. (0.68 kg)
5POB45020	3/8" (10 mm)	25/32" (20 mm)	18" (450 mm)	2.27 lbs. (1.03 kg)
5POB60020	3/8" (10 mm)	25/32" (20 mm)	24" (600 mm)	3.15 lbs. (1.43 kg)
5POB90020	3/8" (10 mm)	25/32" (20 mm)	36" (900 mm)	4.85 lbs. (2.20 kg)



Construction Tools



Star Dropper Hammer



5SDSH

- Used for driving in star (fencing) droppers.
- Also used to drive in marker pegs, stakes and concreting stakes.
- Heavy unit drives droppers very quickly and efficiently.
- Solid steel handles and slug are welded together, which gives greater strength.

Cat. No.	Internal Diameter	Overall Length	Weight
5SDSH	2-1/8" (54 mm)	33-55/64" (860 mm)	19.13 lbs. (8.68 kg)

Star Dropper Remover

- Used for removing star droppers (also called star pickets or fencing droppers).
- Also used for removing selected pipes and steel pegs.
- Gripper made from high-tensile steel for durability and long life.
- Gripper bites efficiently into dropper for easy extraction.
- Long handle for excellent leverage.

Cat. No.	Handle Length	Slot Opening	Overall Height	Weight
5SDR	36" (900 mm)	1-21/64" x 2" (34 x 50 mm)	32" (800 mm)	17.76 lbs. (8.06 kg)



5SDR

All dimensions are in inches and (millimeters).

▲WARNING: Always ensure that you and persons in the vicinity wear approved eye protection and gloves.



Hammers



Drill Hammer – Wooden Handle

- Used for mining and confined environments.
- Also ideal for close work with enough head weight for effective hammering.
- Head forged from high-tensile carbon manganese steel, with hardened and tempered face and claw.
- Fitted with tough Australian spotted gum hardwood handle, oiled for long life and user comfort.
- Handle is fitted to head with a glued wooden and steel wedge assembly.
- Precision heat treated to best suit product application.
- This product must be maintained in accordance with Australian standard AS 3797:1991.



5HDRH2.0

Cat. No.	Head Weight	Overall Length	Weight
5HDRH2.0	4.4 lbs. (2.0 kg)	16" (400 mm)	4.8 lbs. (2.18 kg)

Mason's Club Hammer – Wooden Handle

- Great all-around club hammer for general striking applications.
- Forged from tough high-tensile carbon manganese steel, with hardened and tempered face and claw.
- Fitted with tough Australian spotted gum hardwood handle, oiled for long life and user comfort.
- Ideal for work in confined spaces.
- Handle is fitted to head with a glued wooden and steel wedge assembly.
- Precision heat treated to best suit product application.
- This product must be maintained in accordance with Australian standard AS 3797:1991.



5HCMH1.35

Cat. No.	Head Weight	Overall Length	Weight
5HCMH1.35	3 lbs. (1.35 kg)	10" (250 mm)	3.54 lbs. (1.61 kg)

Brass Sledge Hammers – Fiberglass Rubber Grip Handle



7HBRFRH14

- Used in non-sparking environments or to avoid damage to struck objects.
- Head forged from brass for softer, non-damaging blow.
- Head is pinned to handle as well as epoxied to prevent head coming off.
- Comfortable, thick rubber grip handle for increased protection from shock and vibration.
- Handle includes both overstrike protection and large sweep at base to prevent loss of grip.
- This product must be maintained in accordance with Australian standard AS 3797:1991.

Cat. No.	Head Weight	Overall Length	Weight
7HBRFRH04	4 lbs. (1.81 kg)	16" (400 mm)	4.89 lbs. (2.22 kg)
7HBRFRH07	7 lbs. (3.17 kg)	32" (800 mm)	9.87 lbs. (4.48 kg)
7HBRFRH10	10 lbs. (4.53 kg)	36" (900 mm)	12.23 lbs. (5.55 kg)
7HBRFRH14	14 lbs. (6.35 kg)	36" (900 mm)	16.73 lbs. (7.59 kg)

All dimensions are in inches and (millimeters).

⚠WARNING: Always ensure that you and persons in the vicinity wear approved eye protection and gloves.



Hammers



Chipping Hammer – Rubber Grip

- Used for chipping off slag and spatter around welds.
- Also used as geologists' or miners' tool.
- Head forged from chrome alloy steel and hardened and tempered for maximum toughness.
- Ground and sharpened vertical chisel and diamond point.
- Excellent balance with hardened ends that do not flatten when chipping.
- Precision heat treated to best suit product application.



5WHRG

Cat. No.	Head Length	Overall Length	Weight
5WHRG	6-11/16" (170 mm)	10-15/64" (260 mm)	1.14 lbs. (0.52 kg)

Safety Punches

Hand Saver Punch



7WRP22

- Used to safely drive out pins and keys in machinery.
- Long, two-handed rubber handle to lessen shocks from blows.
- Head attached with wire rope to reduce shock.
- Urethane ring around head to reduce likelihood of chipping.
- Heat-treated punch, so it will not shatter.

Cat. No.	Diameter	Shaft Length	Weight (lbs.)
7WRP13	1/2" (13 mm)	4-3/4" (120 mm)	2.98 (1.35 kg)
7WRP16	5/8" (16 mm)	4-3/4" (120 mm)	3.20 (1.45 kg)
7WRP19	3/4" (19 mm)	4-3/4" (120 mm)	3.64 (1.65 kg)
7WRP22	7/8" (22 mm)	4-3/4" (120 mm)	4.41 (2.00 kg)
7WRP25	1" (25 mm)	4-3/4" (120 mm)	4.63 (2.10 kg)
7WRP32	1-1/4" (32 mm)	4-3/4" (120 mm)	5.29 (2.40 kg)

All dimensions are in inches and (millimeters).

▲WARNING:

Strike squarely - avoid glancing blows. Always ensure that you and persons in the vicinity wear approved eye protection and gloves.

▲WARNING:

This tool can be made to chip if struck against another tool or other hard object, resulting in possible eye or other injury.



Tyre (Tire) Products



Tyre (Tire) Lever



5TL600

- Used for removal and fitting of 4WD car and truck tires.
- Forged from tough chrome alloy steel.
- Precision hardened and tempered to be tough and resilient.
- Fine tapered and ground ends for easier use and prevention of damage to tires.

Cat. No.	Thickness	Width	Overall Length	Weight
5TL600	27/64" (10.8 mm)	1-7/64" (28 mm)	24 -1/2" (620 mm)	2.51 lbs. (1.14 kg)



All dimensions are in inches and (millimeters).

▲WARNING:
Strike squarely - avoid glancing blows. Always ensure that you and persons in the vicinity wear approved eye protection and gloves.

▲WARNING:
This tool can be made to chip if struck against another tool or other hard object, resulting in possible eye or other injury.

Sheet Metal Tools/HVAC

Klein's line of sheet metal and HVAC tools make it easy to work with sheet metal, ductwork and tubing. These job-matched tools are proven to stand the test of time with superior results.

F O R P R O F E S S I O N A L S . . . S I N C E 1 8 5 7 ®



Sheet Metal Tools/HVAC

HVAC



Cutting & Notching Tools – Journeyman™ Snips

JOURNEYMAN

Features:

JOURNEYMAN

Exclusive Klein Kurve® design for added comfort.

Soft touch grips for maximum control and comfort.

Self opening latch.

Long-lasting serrated forged steel blades for superior strength and durability.

Hard, colored material for toughness and durability.

Premium corrosion – resistant plated handles.

Tip-Ident® for easy identification.

Meets or exceeds ASME B107.16M performance standard.



Sheet Metal Tools/HVAC

Aviation Snips

Additional Features:

- J1100L, J1101R, J1102S Journeyman snips cut 18 gauge cold rolled steel and 22 gauge stainless steel.
- J2103S Journeyman Bulldog snips cut 16 gauge cold rolled steel and 18 gauge stainless steel.

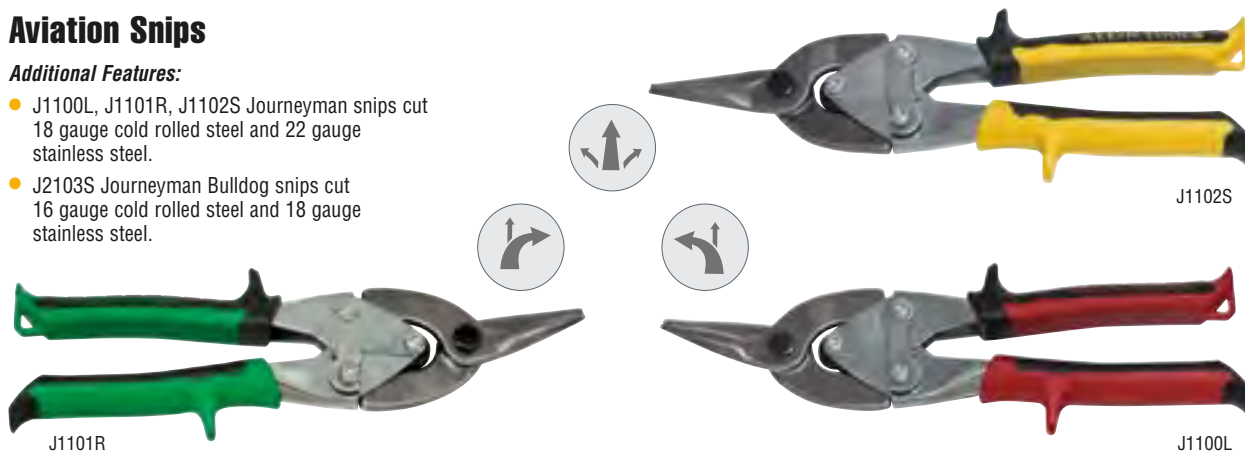

Cat. No.	Cutting Pattern	Snip Type	Cutting Length	Color Code	Overall Length	Cutting Capacity: Cold Rolled/Stainless Steel	Weight (oz.)
J1100L	left/straight	aviation	1-3/8" (35 mm)	red/black	9-7/8" (250 mm)	18 gauge/22 gauge	14.4
J1101R	right/straight	aviation	1-3/8" (35 mm)	green/black	9-7/8" (250 mm)	18 gauge/22 gauge	14.7
J1102S	straight/wide curves	aviation	1-1/2" (38 mm)	yellow/black	10-1/16" (255 mm)	18 gauge/22 gauge	14.4
J2103S	notch/straight	bulldog	7/8" (22 mm)	yellow/black	9-7/16" (240 mm)	16 gauge/18 gauge	13.9

Right Angle Snips

Additional Features:

- J2104L, J2105R Journeyman snips cut straight, curves, and tight circles in 24 gauge cold rolled steel and 28 gauge stainless steel.
- Makes cutting easier in confined spaces (in ductwork, reaching through openings or against a wall).

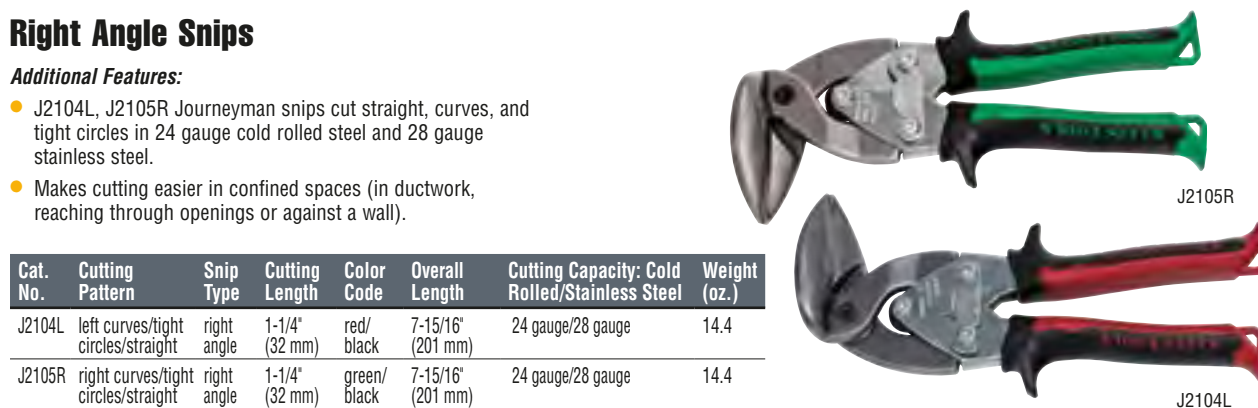

Cat. No.	Cutting Pattern	Snip Type	Cutting Length	Color Code	Overall Length	Cutting Capacity: Cold Rolled/Stainless Steel	Weight (oz.)
J2104L	left curves/tight circles/straight	right angle	1-1/4" (32 mm)	red/black	7-15/16" (201 mm)	24 gauge/28 gauge	14.4
J2105R	right curves/tight circles/straight	right angle	1-1/4" (32 mm)	green/black	7-15/16" (201 mm)	24 gauge/28 gauge	14.4

All dimensions are in inches and (millimeters).

⚠WARNING: Always wear approved eye protection.

⚠WARNING: Never use on or near live electrical circuits

⚠WARNING: NOT insulated. Will NOT protect against electrical shock.



Offset Snips

Additional Features:

- J2100L, J2101R, J2102S and J2106S snips feature exclusive Klein Kurve® handles for natural hand positioning and ease of use.
- J2106S Journeyman snips cut 20 gauge cold rolled steel and 24 gauge stainless steel, with a 2-3/8" length of cut for faster cutting.
- J2100L, J2101R and J2102S Journeyman snips cut 18 gauge cold rolled steel and 22 gauge stainless steel.



Cat. No.	Cutting Pattern	Snip Type	Cutting Length	Color Code	Overall Length	Cutting Capacity: Cold Rolled/Stainless Steel	Weight (oz.)
J2100L	left/straight	offset	1-1/4" (32 mm)	red/black	9-1/2" (241 mm)	18 gauge/22 gauge	15.5
J2101R	right/straight	offset	1-1/4" (32 mm)	green/black	9-1/2" (241 mm)	18 gauge/22 gauge	15.7
J2102S	straight/wide curves	offset	1-1/2" (38 mm)	yellow/black	9-1/2" (241 mm)	18 gauge/22 gauge	15.5
J2106S	straight/wide curves	long cut offset	2-3/8" (60 mm)	yellow/black	10-1/2" (266 mm)	20 gauge/24 gauge	18.2

Cutting & Notching Tools

Aviation Snips – Regular/Offset/Bulldog

- Forged and heat-treated steel blades for strength and durability.
- Regular and offset blades have the capacity of cutting 18 gauge cold-rolled sheet metal and 22 gauge stainless steel sheet metal.
- Offset blades provide ease of cutting tight curves and keep user's hand away from metal.
- Bulldog snips (Cat. No. 2103) for notching or trimming 16 gauge cold-rolled sheet metal and 18 gauge stainless steel sheet metal.
- Spring-loaded for self-opening action.
- Latch keeps jaws closed when not in use.
- Hardened handles for extra strength.
- Contoured plastic handles are comfortable and color-coded by cutting pattern.



Cat. No.	Cutting Pattern	Snip Type	Cutting Length	Color Code	Overall Length	Cutting Capacity	Weight (oz.)
1100L	left / straight	aviation	1-3/8" (35 mm)	red	9-3/4" (248 mm)	18 ga.	14.4
1101R	right / straight	aviation	1-3/8" (35 mm)	green	9-3/4" (248 mm)	18 ga.	14.7
1102S	straight / wide curve	aviation	1-1/2" (38 mm)	yellow	10-1/8" (257 mm)	18 ga.	14.4
2100L	left / straight	offset	1-1/4" (32 mm)	red	9-1/2" (241 mm)	18 ga.	15.5
2101R	right / straight	offset	1-1/4" (32 mm)	green	9-1/2" (241 mm)	18 ga.	15.7
2102S	straight / wide curve	offset	1-1/2" (38 mm)	yellow	9-1/2" (241 mm)	18 ga.	15.5
2103	notch	bulldog	7/8" (22 mm)	yellow	9-1/4" (235 mm)	16 ga.	13.9

Replacement springs for aviation snips

P406 replacement spring for Cat. Nos. 1100L and 1102S

P407 replacement spring for Cat. No. 1101R

All dimensions are in inches and (millimeters).

⚠WARNING: Always wear approved eye protection.

⚠WARNING: Never use on or near live electrical circuits

⚠WARNING: NOT insulated. Will NOT protect against electrical shock.



Cutting & Notching Tools

Snap Lock Punch

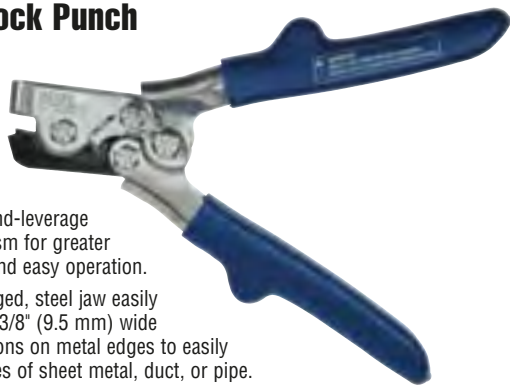

- Compound-leverage mechanism for greater control and easy operation.
- Drop-forged, steel jaw easily punches 3/8" (9.5 mm) wide impressions on metal edges to easily join pieces of sheet metal, duct, or pipe.
- All-steel construction and nickel-chrome plated hardware provide long life and durability.
- Vinyl grips with handle stops for added comfort and easy operation.

86560

Cat. No.	Overall Length	Handle Color	Weight (lbs.)
86560	8" (203 mm)	blue	1.0

Lightweight Tinner Snips



- 6° angled, hollow-ground cutting edge for cutting full 3-1/2" (89 mm) straight cuts and wide curves.
- Easily replaceable cutting blades made of high-carbon steel.
- Cutting capacity: 22 gauge cold-rolled sheet metal; 26 gauge stainless steel sheet metal. Do not use to cut hardened wire, nails, or any other rounded surface.
- Lightweight magnesium handles.

3100

Cat. No.	Overall Length	Handle Color	Weight (oz.)
3100	13" (330 mm)	gray	13.4

Replacement Parts

3101	replacement blades for Cat. No. 3100
------	--------------------------------------

Hand Notcher



- Allows quick, clean, 30° "V" shaped cuts in sheet metal.
- Drop-forged, high-impact steel jaw with 13/16" (21 mm) maximum throat depth.
- Jaws' hook design allows easy notching of corners and take-off tabs without slippage.
- All steel construction with nickel-plate and black-oxide finish provides long life and durability.
- Hardened steel handles include hand guards and are covered with vinyl grips for added comfort and easy operation.

86551

Cat. No.	Overall Length	Handle Color	Weight (lbs.)
86551	8-1/2" (216 mm)	blue	1.0

Nibbler Tool

- Cuts soft sheet metal, plastic, soft copper and aluminum, and tubing.
- Ideal for air conditioning and heating installation, automobile work, model making, and sheet metal construction.



- 1/4" cutting kerf.

76011B

Cat. No.	Description	Cuts Up to	Weight (oz.)
76011B	nibbler cutter with blade	18 gauge soft sheet metal, soft copper and aluminum up to 1/16", and tubing from a 1" I.D.	5.6

Replacement Parts

76012B	replacement blade for Cat. No. 76011B
--------	---------------------------------------

Seaming & Folding Tools

Seamers – Straight and Offset

- Compound-leverage mechanism easily and accurately bends, seams, and flattens sheet metal and non-ferrous metals.
- Jaw marked in 1/4" (6 mm) increments for precise bending measurements.
- All-steel construction and nickel-chrome plated hardware provide long life and durability.
- Vinyl grips with handle stops for added comfort and easy operation.
- Straight-handle model is used for most general applications.
- Offset-handle model (not pictured) is for use in overhead or confined areas .
- Broader jaw model for forming wider folds.
- Folds 22 gauge CRSM and 24 gauge SSSM.

Cat. No.	Type	Jaw Size	Overall Length	Handle Color	Weight (lbs.)
86553	straight-hand seamer	3"	8-3/8" (213 mm)	blue	1.45
86552	offset-hand seamer	3"	8" (203 mm)	blue	1.46
86556	straight-hand seamer	6"	8-3/8" (213 mm)	blue	1.87



86556

All dimensions are in inches and (millimeters).

⚠WARNING: Always wear approved eye protection.

⚠WARNING: Never use on or near live electrical circuits.

Seaming & Folding Tools

Seamer Tongs, Straight and Offset

- Hot-drop forged for strength.
- Bending depth indicators marked in 1/4" (6 mm) increments.
- Cushioned handles.
- Offset-handle model for greater power and easy use in overhead and confined areas.



Cat. No.	Type	Jaw Size	Overall Length	Bends	Handle Color	Weight (lbs.)
86554	offset	3"	9-3/4" (248 mm)	22 ga. CRSM	red	1.8
86555	straight	3"	9-3/4" (248 mm)	22 ga. CRSM	red	1.8

Tube Benders

Swivel Handle Tube Bender

- Swivel handle repositions midway through bend to gain control, reduce efforts, and prevent handles from crossing.
- Easily fabricates bends up to 180°.
- Calibrated to show angle of bend.



Cat. No.	Closed Overall Length	Tube O.D.	Weight (lbs.)
8900-3/8	14-1/4" (362 mm)	3/8"	1.75
8900-1/2	21-7/8" (556 mm)	1/2"	3.50

8900-1/2

Professional 4-in-1 Tube Bender



89030

- Bends four popular tube sizes.
- Calibrated markings for accurate left-hand, right-hand, and offset bends up to 90°.
- For soft copper, aluminum, and steel tubing.
- Bends 3/16", 1/4", 5/16" and 3/8" (6 mm and 8 mm) O.D. tubing.

Cat. No.	Closed Overall Length	Weight (lbs.)
89030	10" (254 mm)	1.0

Folding Tools



88980

- Two folding depths: 3/8" (10 mm) and 1" (25 mm).
- Handy sight gauges for accurate depth alignment.
- Made of heavy-duty 16 gauge steel for folding strength.

Cat. No.	Overall Length	Folds	Weight (lbs.)
88980	12" (305 mm)	24 ga. CRSM and 28 ga. SSSM	1.3
88981	18" (457 mm)	24 ga. CRSM and 28 ga. SSSM	2.0
88982	24" (610 mm)	24 ga. CRSM and 28 ga. SSSM	2.6

Spring Type Tube Bender Sets

- 8-Pc. Set: Bends 1/4" to 7/8" O.D. tubing.
3-Pc. Set: Bends 1/4" to 3/8" O.D. tubing.
- Easily allows hand bending of soft copper and aluminum tubing into any shape without collapsing walls.
- Belled end for quick tube removal.

Cat. No.	Type	Overall Length	Weight (oz.)
89018	8 pc. set	10" (254 mm) - 12" (305 mm)	50.75
89019	3 pc. set	10" (254 mm)	10



89019

All dimensions are in inches and (millimeters).

⚠ WARNING: Always wear approved eye protection.

⚠ WARNING: Never use on or near live electrical circuits.



Tube Cutters

Professional Tube Cutter



88904

- Accurate 4 roller tracking system – no spiraling.
- Professional reaming tool.
- Extra cutting wheel included in handle.

Cat. No.	Overall Length	Cuts	Weight (lbs.)
88904	6-1/32" (153 mm)	1/8" - 1-1/8" steel and copper tubing	1.31
Replacement Parts			
88905	replacement wheel for Cat. No. 88904		.08

Professional Tube Cutter



88975

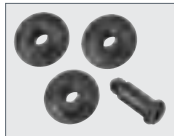

88976

- Smooth feed mechanism for precise, right angle cutting action.
- Includes retractable reamer with filing surface and spare cutter wheel.
- Not designed for cutting stainless steel or hard tempered tubing.

Cat. No.	Overall Length	Cuts	Weight (oz.)
88975	5" (127 mm)	1/8" - 1-1/8" O.D. tubing	9.5
Replacement Parts			
88976	replacement wheels + screw for Cat. No. 88975		

Swaging Tool – Punch Type

Professional 6-in-1 Swaging Punch



66400

- Swages six sizes of tubing.
- Hex design for ease of extraction.
- Precision machined surface for ease of forming.
- High-alloy steel, heat-treated for strength and durability.

Cat. No.	Overall Length	Swages	Weight (oz.)
66400	5-3/16" (132 mm)	3/16", 1/4", 5/16", 3/8", 1/2", 5/8" O.D. tubing	5.92

Professional Mini Tube Cutter



88977



88978

- Perfect for tight space cutting. Requires only 1-3/8" swing radius.
- Smooth feed mechanism for precise, right angle cutting action.
- Not designed for cutting stainless steel or hard tempered tubing.

Cat. No.	Overall Length	Cuts	Weight (oz.)
88977	1-3/4" (44 mm)	1/8"-5/8" O.D. tubing	2.5
Replacement Parts			
88978	replacement wheels + screw for Cat. No. 88977		

Tube Cutter Accessories

Inner-Outer Reaming and Deburring Tool

- Reams inside and outside edges of tubing.
- Deburrs with clockwise and counter-clockwise rotations.
- Reams copper, aluminum, PVC, and brass tubing.



89025

Cat. No.	Overall Length	Color	Reams	Weight (oz.)
89025	2-1/4" (57 mm)	yellow	3/16" to 1-1/2" O.D. tubing	10.08

Tube Flaring & Swaging Tools

45° Flaring and Swaging Tool Sets



89020

Includes case

- Converts from flares to swages with easy screw-on application.
- Self-centering, slip-on forged steel yoke easily forms quality flares/swages.
- Flares 1/8", 3/16", 1/4", 5/16", 3/8", 7/16", 1/2", 5/8" and 3/4" O.D.
- Swages 3/16", 1/4", 5/16", 3/8", 1/2", 5/8" and 3/4" O.D. tubing.
- Cat. No. 89021 Flares 3/16", 1/4", 5/16", 3/8", 7/16", 1/2" and 5/8" O.D. tubing.

Cat. No.	Dimensions	Weight
89020	6-1/8" L (157 mm) x 6-1/2" W (165 mm) x 4-13/32" H (112 mm)	4.71 lbs.
89021	7" (178 mm) L x 4-13/16" W (122 mm) x 3-9/32" H (236 mm)	2.0 lbs.

All dimensions are in inches and (millimeters).

⚠WARNING: Always wear approved eye protection.

⚠WARNING: Never use on or near live electrical circuits.



Duct Stretching & Slitting Tools

Duct Stretcher



89565

- Aligns and pulls ductwork together, easing installation of drive cleats.
- Offset handle protects hand.

Cat. No.	Overall Length	Weight (oz.)
89565	16" (406 mm)	12

Duct Slitting Tool



DS7

- Blade used to scribe a line or pierce and enlarge holes in sheet metal.
- Cushion-Grip handle for greater comfort and control.
- Patented Tip-Ident® quickly identifies the type of tool and tip orientation.

Cat. No.	Overall Length	Weight (oz.)
DS7	12-5/8" (321 mm)	5.6

Crimping Tools

5-Blade Crimper

- Produces factory-precision indentations in stove pipe and round duct with just a squeeze.
- Compound-leverage mechanism, heavy-duty jaw/handle linkage, and closing stop provide easy operation and consistent crimps for virtually leak-proof connections.
- Hardened steel handles include hand guards covered with vinyl grips for added comfort and easy operation.
- All steel construction and nickel-plating provide long life and consistent crimp profile.



86550

Cat. No.	Overall Length	Crimps	Handle Color	Weight (lbs.)
86550	9" (229 mm)	24 ga. CRSM and 28 ga. SSSM	blue	1.00

Sheet Metal Fasteners

Self-Piercing Sheet Metal Screws

- Zinc plated.
- Sheet metal screws with self piercing tips.
- Slotted 1/4" hex head washer.



8910-3/4

Cat. No.	Length	Driver Type	Size	Qty	Head Type
8910-3/4	3/4" (19 mm)	1/4" slotted	#8	1000	hex washer
8910-1/2	1/2" (13 mm)	1/4" slotted	#8	1000	hex washer

Magnetic Hex Drivers

Magnetic Hex Drivers

- For driving sheet metal screws.
- Strong Rare Earth magnets for maximum holding.
- 1/4" hex shank with quick release groove.



86602

Cat. No.	Description	Overall Length	Weight (lbs.)
3-Pack			
86600	1/4" magnetic hex driver – 3 pack	1-3/4" (45 mm)	.12
86601	5/16" magnetic hex driver – 3 pack	1-3/4" (45 mm)	.14
86602	3/8" magnetic hex driver – 3 pack	1-3/4" (45 mm)	.16
10-Pack Punch Card for Individual Sale			
86600-10	1/4" magnetic hex driver	1-3/4" (45 mm)	.43
86601-10	5/16" magnetic hex driver	1-3/4" (45 mm)	.49
86602-10	3/8" magnetic hex driver	1-3/4" (45 mm)	.57

All dimensions are in inches and (millimeters).

⚠WARNING: Always wear approved eye protection.

⚠WARNING: Never use on or near live electrical circuits.



Refrigeration Wrenches

Ratcheting Refrigeration Wrenches

- Fully reversible ratchet wrenches designed for refrigeration packing gland nuts and valve stem sockets.
- Also designed for beam-clamp installation.
- Wrenches are compact in size, with clearly marked sockets for four nut sizes.
- Quick-flip reversing lever permits instant ratchet reversal.
- Wrenches are ruggedly built and have polished chrome finish with smooth edges for comfort.



68310

Cat. No.	Socket Sizes	Length	Weight (lbs.)
68309	3/16" and 1/4" sq. x 1/2" and 9/16" hex	6-13/16" (173 mm)	.43
68310	3/16" and 5/16" sq. x 1/4" and 3/8" sq.	5-1/2" (140 mm)	.20
68310-24	24 pack of Cat. No. 68310	5-1/2" (140 mm)	4.70

Nylon Tie Tensioning Tools

Nylon Tie Tensioning Tools

- Designed for work with ties rated at 120 - 250 lbs. (54 - 113 kg).
- Tensions up to 65 lbs. of force (30 kg).
- Maximum tie width of 15/32" (12 mm).
- Handle grips for comfort.
- Excess tie material is automatically cut off (Cat. No. 86571 only).

Cat. No.	Description	Weight (lbs.)
86570	nylon tie tensioning tool – manual	0.87
86571	nylon tie tensioning tool – automatic	1.01



86571



86570

Special-Purpose Knives

Serrated Duct Knife

- Cuts duct board and flexible duct.
- Double-edged knife – regular and serrated.
- Cushion-grip handle for comfort.
- Includes puncture resistant nylon sheath with belt loop.



DK06

Cat. No.	Blade Steel	Blade Length	Weight (lbs.)
DK06	stainless steel	5.5" (140 mm)	0.53



Specialty Screwdrivers

11-in-1 Screwdriver/Nut Driver with Schrader® Valve Removal/Installation Bit

Additional Features:

- Includes unique style bit for installation/removal of common TR-4 Schrader® valves and aggressive thread extractor tip for backing out broken cores.
- Great for HVAC and other industrial applications.
- Cushion-Grip handle for greater torque and comfort.
- Blast finish bit tips provide a firm hold and reduce cam out.



32527

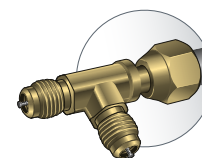

Schrader® is a registered trademark of Schrader International, Inc.

Cat. No.	Contains	Weight (lbs.)
32527	3/8", 5/16" and 1/4" nut drivers, #1 and #2 Phillips, #1 square and #2 square, 1/4" and 3/16" slotted, Schrader® valve core removal/installation – extractor	.44

All dimensions are in inches and (millimeters).

WARNING: Always wear approved eye protection.

WARNING: Never use on or near live electrical circuits.



Hammers

Setting Hammer



820-16

- Durable epoxy resin handle helps to protect neck from fraying and splintering if incorrectly struck or over struck.
- High-strength fiberglass shaft absorbs shock and keeps head tight.
- Cushioned, PVC grip bonded to handle.
- Special high-carbon steel, octagon shaped head with flat striking surface and rounded cross peen.

Cat. No.	Head Weight	Overall Length	Weight (lbs.)
820-16	16 oz. (454 g)	13" (330 mm)	1.6

Riveting Hammer



821-12

- High-carbon steel round head is forged and hardened.
- Flat striking surface with rounded cross peen.
- Straight-grain American hickory handle is stained and lacquered.

Cat. No.	Head Weight	Overall Length	Weight (lbs.)
821-12	12 oz. (340 g)	12-1/4" (311 mm)	1.1

Dead Blow Hammers



811-16

- Durable, abrasion resistant non-marring hammer face.
- Increased striking force with zero impact rebound.
- Design isolates user from striking impact and reduces fatigue.
- 40% more driving power than other dead blow hammers.
- Protects job surface from damage.
- Applications: HVAC, metal fabrication, electronics, oil and mining, wood and metal assembly, automotive, aerospace.

Cat. No.	Overall Length	Head Weight	Weight (lbs.)
811-16	12.5" (318 mm)	16 oz. (454 g)	1.44
811-32	18" (457 mm)	32 oz. (908 g)	1.8



All dimensions are in inches and (millimeters).

WARNING: Always wear approved eye protection.

Holemaking Products & Accessories

Made of top-of-the-line materials for longer lasting performance, Klein's diverse line of drill bits and holemaking products and accessories provide accuracy and consistency to get the job done right.

For Professionals... Since 1857®

Holemaking Products & Accessories



Flexible Drill Bits

Flex Bit Augers



- Used to drill holes through wood within a wall.
- Tapered back for easy bit retrieval.
- Spring steel shaft resists deformation.
- Screw point tip pulls the bit through wood.
- Hole in tip allows for use with wire or cable pulling grip.

Cat. No.	Length	Weight (lbs.)
53716	3/8" x 54" (9.5 mm x 1372 mm)	1.00
53717	3/8" x 72" (9.5 mm x 1829 mm)	1.00
53718	9/16" x 54" (14 mm x 1372 mm)	1.00
53719	3/4" x 54" (19 mm x 1372 mm)	2.00
53751	3/4" x 72" (19 mm x 1829 mm)	2.00
53720	1" x 54" (25 mm x 1829 mm)	2.00



53719

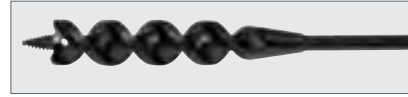

53720



53718



53716

Flex Bit Extensions



53722

- Connects to the end of a flex bit and extends the length.

Cat. No.	For Use with Flex Bits	Length	Connection Diameter	Weight (lbs.)
53722	3/4" and larger	54" (1372 mm)	5/8" (14 mm)	1.00
53723	9/16" and smaller	54" (1372 mm)	7/16" (11 mm)	1.00

Flex Bit Placement Tool

- For use with flexible drill bits.
- Positions flexible drill bits horizontally or vertically within a wall.
- Cushion Grip handle for non-slip comfort.
- Folding design stores more compactly than standard tool.



53715

Cat. No.	Length	Weight (lbs.)
53715	11" (279 mm)	1.00

All dimensions are in inches and (millimeters) unless otherwise specified.

WARNING: Always wear approved eye protection.

WARNING: Never use on or near live electrical circuits.

NOTE: Read and follow safety instructions in power tool owner's manual.



Pulling Grips

Pulling Grips



KPS050



KPS075

- Used to pull wire or cable through walls.
- Pulling grip attaches to the hole in the tip of the flex bit; wire mesh holds the wire during the pull.
- Swivel end helps reduce twisting

Cat. No.	Capacity	Maximum Safe Load	Weight (lbs.)
KPS050	1/2" - 9/16" (12 mm - 14 mm)	100 lb	.07
KPS075	3/4" - 1" (19 mm - 25 mm)	185 lb	.11

⚠WARNING: Do not exceed maximum safe load as listed on the label attached to the product.

⚠WARNING: Always match proper size and type of grip to application.

⚠WARNING: Always inspect equipment before use.

Flex Bit Kit

Flex Bit Kit

- 3-piece kit includes folding placement tool, 1/2"-9/16" O.D. pulling grip and 9/16" x 54" flexible drill bit.
- Everything you need to pull up to 9/16" O.D. wire.
- Complete kit used for drilling and pulling wire and cable.
- Use placement tool (Cat. No. 53715) to guide bit through walls.
- Flexible drill bit (Cat. No. 53718) makes 9/16" holes in wood.
- Pulling grip (Cat. No. KPS050) attaches to the flexible drill bit after the hole has been made and pulls 1/2" - 9/16" wire and cable.

Cat. No.	Kit Contains	Weight (lbs.)
53721		2.00

Cat. No.	Description
53715	flex bit placement tool
53718	flex drill bit - 9/16" x 54" (14 mm x 1372 mm)
KPS050	pulling grip - 1/2"-9/16" (12 mm - 14 mm)



53721

All dimensions are in inches and (millimeters) unless otherwise specified.

NOTE: Read and follow safety instructions in power tool owner's manual.

⚠WARNING: Never use on or near live electrical circuits.

⚠WARNING: Always ensure that you and persons in the vicinity wear approved eye protection.



Hole Saw Kits

Master Electrician's Hole Saw Kit

- Includes the most commonly used saws and arbors.
- All components are packed in a metal carrying case.

Cat. No.	Set Contains		Weight (lbs.)
31640			8.10
	Hole Saws		
	Cat. No.	Size	
	31514	7/8"	
	31518	1-1/8"	
	31522	1-3/8"	
	31528	1-3/4"	
	31532	2"	
	31540	2-1/2"	
	31548	3"	
	31558	3-5/8"	
	31566	4-1/8"	
	31572	4-1/2"	
	Arbors		
	Cat. No.	Size	
	31650	1/4"	
	31660	7/16"	
	31670	7/16"	

Note: Set pilot drill point 1/8" beyond tooth points.

Large Size Hole Saw Kit

- Contains the sizes necessary to upgrade an Electrician's Hole Saw Kit into a Master Electrician's set.
- All components are packed in a metal carrying case.

Cat. No.	Set Contains		Weight (lbs.)
31645			6.60
	Hole Saws		
	Cat. No.	Size	
	31548	3"	
	31558	3-5/8"	
	31566	4-1/8"	
	31572	4-1/2"	
	Arbors		
	Cat. No.	Size	
	31670	7/16"	

Note: Set pilot drill point 1/8" beyond tooth points.

Electrician's Hole Saw Kit

- Contains the most popular sizes for basic electrical work.
- All components are packed in a rust-proof, molded plastic carrying case.

Cat. No.	Set Contains		Weight (lbs.)
31630			2.60
	Hole Saws		
	Cat. No.	Size	
	31514	7/8"	
	31518	1-1/8"	
	31522	1-3/8"	
	31528	1-3/4"	
	31532	2"	
	31540	2-1/2"	
	Arbors		
	Cat. No.	Size	
	31660	7/16"	
	31670	7/16"	

Note: Set pilot drill point 1/8" beyond tooth points.

All dimensions are in inches and (millimeters) unless otherwise specified.

NOTE: Read and follow safety instructions in power tool owner's manual.

WARNING: Never use on or near live electrical circuits.



31640

Journeyman's Hole Saw Kit

- The most frequently used sizes and an arbor extension for hard to reach spots.
- All components are packed in a rust-proof, molded plastic carrying case.

Cat. No.	Set Contains		Weight (lbs.)
31635			4.50
	Hole Saws		
	Cat. No.	Size	
	31512	3/4"	
	31514	7/8"	
	31518	1-1/8"	
	31522	1-3/8"	
	31524	1-1/2"	
	31528	1-3/4"	
	31532	2"	
	31536	2-1/4"	
	31540	2-1/2"	
	Arbors		
	Cat. No.	Size	
	31650	1/4"	
	31660	7/16"	
	31670	7/16"	
	Arbor Extender		
	Cat. No.	Size	
	31678	12"	

Note: Set pilot drill point 1/8" beyond tooth points.



Hole Saws

Bi-Metal Hole Saws

- Cuts through steel, wood, plastic, stainless steel, and cast iron.
- Rugged bi-metal cobalt construction for heavy-duty cutting.
- Deep cup cuts through studs in one pass.
- Variable pitch teeth for faster, smoother cutting and less vibration.
- Longer lasting design for more cuts per saw.
- Multiple knock-out slots and holes for easy core removal.



31600



31532

Cat. No.	Saw Diameter	Pipe Tap Size*	Pipe Entr. Size**	For Use with Arbor No.	Weight (lbs.)
31510	5/8" (16 mm)	—	—	31650, 31655, 31660	.05
31512	3/4" (19 mm)	1/2" (13 mm)	3/8" (10 mm)	31650, 31655, 31660	.06
31514	7/8" (22 mm)	3/4" (19 mm)	1/2" (13 mm)	31650, 31655, 31660	.60
31516	1" (25 mm)	—	—	31650, 31655, 31660	.07
31518	1-1/8" (29 mm)	1" (25 mm)	3/4" (19 mm)	31650, 31655, 31660	.08
31520	1-1/4" (32 mm)	—	—	31665, 31670	.09
31522	1-3/8" (35 mm)	—	1" (25 mm)	31665, 31670	.12
31524	1-1/2" (38 mm)	1-1/4" (32 mm)	—	31665, 31670	.09
31526	1-5/8" (41 mm)	—	—	31665, 31670	.10
31528	1-3/4" (44 mm)	1-1/2" (38 mm)	1-1/4" (32 mm)	31665, 31670	.11
31532	2" (51 mm)	—	1-1/2" (38 mm)	31665, 31670	.13
31534	2-1/8" (54 mm)	—	—	31665, 31670	.14
31536	2-1/4" (57 mm)	2" (51 mm)	—	31665, 31670	.15
31538	2-3/8" (60 mm)	—	—	31665, 31670	.16
31540	2-1/2" (64 mm)	—	2" (51 mm)	31665, 31670	.17
31542	2-5/8" (67 mm)	2-1/2" (64 mm)	—	31665, 31670	.18
31544	2-3/4" (70 mm)	—	—	31665, 31670	.19
31548	3" (76 mm)	—	2-1/2" (64 mm)	31665, 31670	.22
31552	3-1/4" (83 mm)	3" (76 mm)	—	31665, 31670	.26
31556	3-1/2" (89 mm)	—	—	31665, 31670	.28
31558	3-5/8" (92 mm)	—	3" (76 mm)	31665, 31670	.29
31564	4" (102 mm)	—	—	31665, 31670	.33
31566	4-1/8" (105 mm)	—	3-1/2" (89 mm)	31665, 31670	.36
31568	4-1/4" (108 mm)	4" (102 mm)	—	31665, 31670	.36
31572	4-1/2" (114 mm)	—	4" (102 mm)	31665, 31670	.40
31576	4-3/4" (121 mm)	—	—	31665, 31670	.50
31580	5" (127 mm)	—	—	31665, 31670	.54
31596	6" (152 mm)	—	—	31665, 31670	.75
31600SEN	6-3/8" (162 mm)	—	—	31665, 31670	2.00
31606	6-5/8" (168 mm)	—	—	31665, 31670	2.25

Note: Set pilot drill point 1/8" beyond tooth points.

Note: Pipe sizes listed in the "Pipe Tap Size" and "Pipe Entrance Size" columns are standard industry sizes. All pipes are sized by the nominal inside diameter.

*Pipe Tap Size – The sizes listed provide the necessary information whenever a pipe is to be threaded into tanks, boilers, etc. To secure the best results, the hole should be reamed before tapping with a reamer having a taper of 3/4" per foot.

**Pipe Entrance Size – The sizes listed provide the necessary information for any given pipe size to have sufficient clearance to pass through beams, walls, bulkheads, etc.

All dimensions are in inches and (millimeters) unless otherwise specified.

NOTE: Read and follow safety instructions in power tool owner's manual.

WARNING: Never use on or near live electrical circuits.

WARNING: Always ensure that you and persons in the vicinity wear approved eye protection.



Hole Saws

Carbide Grit Hole Saws

- Available in the most common sizes for recessed can lights.
- Carbide grit for smooth cuts and minimal tear out.
- Long-lasting carbide grit will not dull in abrasive materials.
- Grit design reduces the kick when starting a cut in plywood.
- Cuts through drywall, ceiling tile, lathe/plaster, cement board and wood.

Cat. No.	Saw Diameter	For Use with Arbor No.	Weight (lbs.)
31605	6-3/8" (161 mm)	31168, 31665, 31670	1.65
31607	6-5/8" (168 mm)	31168, 31665, 31670	1.65
31611	6-7/8" (174 mm)	31168, 31665, 31670	1.75

Note: Set pilot drill point 1/8" beyond tooth points.



31605

Hole-Saw Arbors and Accessories

- 118° split point pilot bits.
- Hardened mandrels for long thread life.



31676



31670



31650



31655



31660



31665

* Collar O.D. 3/4" (19 mm)

Note: Set pilot drill point 1/8" beyond tooth points.



31678

Cat. No.	Shank Style	Pins	Shank Size	Electric Drill Size	Thread Size	Weight (lbs.)
31650	round tri-lobe	N	1/4" (6 mm)	1/4" and larger	1/2" - 20	.14
31655	hexagonal	N	3/8" (10 mm)	3/8" and larger	1/2" - 20	.16
31660	hexagonal	N	7/16" (11 mm)	1/2" and larger	1/2" - 20	.16
31665	hexagonal	N	7/16" (11 mm)	1/2" and larger	5/8" - 18	.50
31670	hexagonal	Threaded	7/16" (11 mm)	1/2" and larger	5/8" - 18	.55

Replacement Pilot Drills for Hole-Saw Arbors

31672	1/4" Replacement Pilot Drill Bit for Klein Arbors 31650, 31660, 31665, 31670	.02
31674	1/4" Replacement Pilot Drill Bit for Klein Arbors 31655	.04
31676	Arbor Adapter; converts 1/2" - 20 to 5/8" - 18	.03
31678	12" Arbor Extender*	7/16" (11 mm) 1/2" and larger - .77

Adjustable Hole Saw

- Quickly and smoothly cuts cleaner holes in drywall and ceiling tiles.
- Blades adjust to cut holes from 2" to 7" in diameter.
- Fits most 3/8" and 1/2" drill chucks.
- No binding while cutting.
- No additional tools needed to adjust the hole saw.
- Newly redesigned dust shield (two included) for longer life.
- Hex key included.

Cat. No.	Range	Weight (lbs.)
53731	2" - 7" (51 mm - 177 mm)	.31



53731

All dimensions are in inches and (millimeters) unless otherwise specified.

NOTE: Read and follow safety instructions in power tool owner's manual.

WARNING: Never use on or near live electrical circuits.

WARNING: Always ensure that you and persons in the vicinity wear approved eye protection.



Carbide-Tipped Hole Cutters

Carbide Hole Cutter

Cat. No.	Size	Conduit & Pipe Sizes	Weight (lbs.)
31850	3/4"	–	.25
31852	7/8"	1/2"	.30
31854	1"	–	.35
31856	1-1/8"	3/4"	.40
31857	1-7/32"	–	.40
31858	1-1/4"	–	.40
31860	1-3/8"	1"	.45
31862	1-7/16"	–	.40
31864	1-1/2"	–	.45
31866	1-3/4"	1-1/4"	.70
31868	2"	1-1/2"	.80
31870	2-1/2"	2"	.95
Replacement Parts			
31874	replacement hole cutter pilot bit		.05



31860

- Cuts quick, precise holes in stainless steel, mild steel, iron, copper and brass sheet up to 3/16" (5 mm) thick.
- Smooth start pilot drill bit for greater control.
- Split point pilot drill bit prevents bit walking.
- Integrated flange prevents the operator from drilling beyond the sheet metal.
- Ejection spring for easy slug removal.

Carbide-Tipped Hole Cutter Kits

4-Piece Carbide Hole Cutter Kit

- Cuts quick, precise holes in stainless steel, mild steel, iron, copper and brass sheet up to 3/16" (5 mm) thick.
- Split point pilot drill bit prevents bit walking.
- Integrated flange prevents the operator from drilling beyond the sheet metal.
- Conduit and pipe sizes: 1/2"-1".

Cat. No.	Set Contains	Weight (lbs.)
31872	Carbide Hole Cutters	1.45
Cat. No.	Size	
31852	7/8"	
31856	1-1/8"	
31860	1-3/8"	
	extra pilot bit	



31872

8-Piece Master Electrician's Hole Cutter Kit

- Cuts quick, precise holes in stainless steel, mild steel, iron, copper and brass sheet up to 3/16" (5 mm) thick.
- Split point pilot drill bit prevents bit walking.
- Integrated flange prevents the operator from drilling beyond the sheet metal.
- Conduit and pipe sizes: 1/2"-2"

Cat. No.	Set Contains	Weight (lbs.)
31873	Carbide Hole Cutters	4.30
Cat. No.	Size	
31852	7/8"	
31856	1-1/8"	
31860	1-3/8"	
31866	1-3/4"	
31868	2"	
31870	2-1/2"	
	2 extra pilot bits	



31873

All dimensions are in inches and (millimeters) unless otherwise specified.

NOTE: Read and follow safety instructions in power tool owner's manual.

WARNING: Never use on or near live electrical circuits.

WARNING: Always ensure that you and persons in the vicinity wear approved eye protection.



Knockout Punches

Knockout Punch Set

- Optimized design reduces wrench effort.
- Slugs are split inside for easy removal.
- Maximum capacity of 10 gauge mild steel. Also cuts aluminum, fiberglass and plastic.
- Punches holes cleanly and accurately.
- Set includes 1/2" or 3/4" punch and die with draw stud.

Cat. No.	Overall Length	Conduit Size	Weight (lbs.)
53727	4" (102 mm)	3/4" (19 mm)	.98
53728	2-5/8" (67 mm)	1/2" (12.5 mm)	.45



Knockout Punch Set with Wrench

- Set includes: 1" ratcheting wrench, knockout punches, dies and draw studs for 1/2", 3/4", 1", 1-1/4", 1-1/2", and 2" conduit sizes.
- Cutting capacity 10 gauge mild steel; also cuts aluminum, fiberglass and plastic.
- Splits slugs for easy removal.
- Punches holes cleanly and accurately.
- Kit includes six different size knockout punches and dies, two draw studs and one ratcheting box end wrench.



Cat. No.				Weight (lbs.)
53732				9.00
Punch Cat. No.	Die Cat. No.	Description	Conduit Size	
53819	53820	knockout punch	1/2" (13 mm)	
53827	53828	knockout punch	3/4" (19 mm)	
53837	53838	knockout punch	1" (25 mm)	
53849	53850	knockout punch	1-1/4" (32 mm)	
53857	53858	knockout punch	1-1/2" (38 mm)	
53867	53868	knockout punch	2" (51 mm)	
Cat. No.	Description	Size		
53873	ratcheting wrench	1" (25 mm)		
53871	draw stud	3/8" x 2-5/8" (9.5 mm x 67 mm)		
53872	draw stud	3/4" x 4" (19 mm x 102 mm)		



▲WARNING: Do NOT push or hammer wrench.

▲WARNING: Do NOT extend handle length of wrench.

All dimensions are in inches and (millimeters) unless otherwise specified.

NOTE: Read and follow safety instructions in power tool owner's manual.

▲WARNING: Never use on or near live electrical circuits.

▲WARNING: Always ensure that you and persons in the vicinity wear approved eye protection.



Step-Drill Bits

High Speed Steel Step-Drill Bits — Inch

- Single-fluted design eliminates skidding and makes for easier resharpening.
- Laser-etched hole sizes are easy-to-read and permanent.
- Anti-skid tip eliminates the need for center punching or pilot hole drilling for most sizes.
- Drill multiple-size holes in thin sections of metal, plastic and wood using a single bit.
- Works in most metals (steel, brass, aluminum, copper), as well as in plastic and wood.



Cat. No.	Quick Reference Number	No. of Hole Sizes per Bit	Size Range (Hole Diameter)	Pilot Hole Required	Electric Drill Size	Depth Penetration for Each Step	Weight (lbs.)
59001	1	13 in 1/32" increments	1/8" to 1/2"	no	1/4" and larger	1/8"	.05
59002	2	8 in 1/16" increments	9/16" to 1"	yes, 1/2" or larger	1/2" and larger	1/8"	.20
59003	3	9 in 1/16" increments	1/4" to 3/4"	no	3/8" and larger	1/8"	.15
59004	4	10 in 1/8" increments	13/16" to 1-3/8"	yes, 3/4" or larger	1/2" and larger	1/8"	.50
59005	5	6 in 1/16" increments	3/16" to 1/2"	no	1/4" and larger	3/8"	.05
59008	8	1	7/8"	no	3/8" and larger	not applicable	.10
59009	9	10 in 1/8" increments	1/4" to 1-3/8"	no	1/2" and larger	1/8"	.46
59011	11	2	7/8" and 1-1/8"	no	1/2" and larger	1/8"	.30
59014	14	12 in 1/16" increments	3/16" to 7/8"	no	3/8" and larger	1/8"	.15

Titanium-Nitride Coated Step-Drill Bits

- Similar to Klein high-speed steel step-drill bits, but with a titanium-nitride coating (82 – 86 Rockwell C hardness).
- Coating reduces friction for cooler, smoother running without lubrication; allows bits to last up to 4 to 5 times longer than steel drill bits.
- Single-fluted design eliminates skidding and makes for easier resharpening.
- Laser-etched hole sizes are easy-to-read and permanent.
- Bits are perfect for drilling accurate, round holes in thin (up to 1/8") metal (steel, brass, aluminum and copper), as well as plastic and wood.
- Anti-skid tip eliminates the need for center punching or pilot hole drilling.



Cat. No.	Quick Reference Number	No. of Hole Sizes per Bit	Size Range (Hole Diameter)	Pilot Hole Required	Electric Drill Size	Depth Penetration for Each Step	Weight (lbs.)
59001T	1T	13 in 1/32" increments	1/8" to 1/2"	no	1/4" and larger	1/8"	.10
59003T	3T	9 in 1/16" increments	1/4" to 3/4"	no	3/8" and larger	1/8"	.15
59005T	5T	6 in 1/16" increments	3/16" to 1/2"	no	1/4" and larger	3/8"	.05
59009T	9	10 in 1/8" increments	1/4" to 1-3/8"	no	1/2" and larger	1/8"	.46
59014T	14T	12 in 1/16" increments	3/16" to 7/8"	no	3/8" and larger	1/8"	.15

All dimensions are in inches and (millimeters) unless otherwise specified.

⚠WARNING: Never use on or near live electrical circuits.

NOTE: Read and follow safety instructions in power tool owner's manual.

⚠WARNING: Always ensure that you and persons in the vicinity wear approved eye protection.

Step-Drill Bits

Cobalt Step-Drill Bits

- Similar to Klein high-speed steel step-drill bits, but with a cobalt finish.
- Coating reduces friction for cooler, smoother running without lubrication; allows bits to last longer than ordinary bits.
- Single-fluted design eliminates skidding and makes for easier resharpening.
- Laser-etched hole sizes are easy-to-read and permanent.
- Bits are perfect for drilling accurate, round holes in thin (up to 1/8") metal (steel, brass, aluminum and copper), as well as plastic and wood.
- Anti-skid tip eliminates the need for center punching or pilot hole drilling.



Cat. No.	No. of Hole Sizes per Bit	Size Range (Hole Diameter)	Pilot Hole Required	Electric Drill Size	Depth Penetration for Each Step	Weight (lbs.)
59031	9 in 1 mm increments	4 mm to 12 mm	no	1/4" and larger	5 mm	.05
59034	10 in 2 mm increments	4 mm to 22 mm	no	3/8" and larger	3.5 mm	.14

Ship-Auger Bits

Ship-Auger Bits with Screw Point

- Bits drill through nails, wood, vinyl, plastics and heavy timber.
- Special bit steel with machine-ground flutes and polished edges for smooth, wobble-free boring.
- Feed-screw pilot draws bit into wood.
- Full length is heat-treated and tempered.
- Deep, open-throat design clears chips for faster, cleaner cuts.
- Shanks are 7/16" hex to fit 1/2" and larger three-jaw chucks.



- Head and twist are ground to correct clearance for easy removal from hole.
- For heavy construction and repair work in mines, on docks and bridges, and for electrical work.

Cat. No.	Bit Size	Twist Length	Overall Length	Weight (lbs.)
53401	11/16"	4" (102 mm)	6" (152 mm)	.30
53402	3/4"	4" (102 mm)	6" (152 mm)	.40
53403	13/16"	4" (102 mm)	6" (152 mm)	.40
53404	7/8"	4" (102 mm)	6" (152 mm)	.50
53405	15/16"	4" (102 mm)	6" (152 mm)	.50
53406	1"	4" (102 mm)	6" (152 mm)	.50
53407	1-1/16"	4" (102 mm)	6" (152 mm)	.60
53408	1-1/8"	4" (102 mm)	6" (152 mm)	.80
53409	1-1/4"	4" (102 mm)	6" (152 mm)	1.00
53410	1-3/8"	4" (102 mm)	6" (152 mm)	.80
53411	1-1/2"	4" (102 mm)	6" (152 mm)	.90
53430	1-1/8"	4-3/4" (121 mm)	7-3/4" (197 mm)	.80
53434	9/16"	15" (381 mm)	18" (457 mm)	.65

Cat. No.	Bit Size	Twist Length	Overall Length	Weight (lbs.)
53435	5/8"	15" (381 mm)	18" (457 mm)	.80
53436	11/16"	15" (381 mm)	18" (457 mm)	.85
53437	3/4"	15" (381 mm)	18" (457 mm)	.95
53438	13/16"	15" (381 mm)	18" (457 mm)	1.05
53439	7/8"	15" (381 mm)	18" (457 mm)	1.20
53440	15/16"	15" (381 mm)	18" (457 mm)	1.50
53441	1"	15" (381 mm)	18" (457 mm)	1.70
53442	1-1/16"	15" (381 mm)	18" (457 mm)	1.95
53443	1-1/8"	15" (381 mm)	18" (457 mm)	1.80
53444	1-1/4"	15" (381 mm)	18" (457 mm)	2.20
53445	1-3/8"	15" (381 mm)	18" (457 mm)	2.80
53446	1-1/2"	15" (381 mm)	18" (457 mm)	3.45

All dimensions are in inches and (millimeters) unless otherwise specified.

WARNING: Never use on or near live electrical circuits.

NOTE: Read and follow safety instructions in power tool owner's manual.

WARNING: Always ensure that you and persons in the vicinity wear approved eye protection.



Drill Bit Sets

13-Piece Regular-Point Drill-Bit Set

- Hinged metal box with one stand-up bit holder.

Cat. No.	Set Contains				Weight (lbs.)	
53002					.60	
Cat. No.	Bit Size	Cat. No.	Bit Size			
53100	1/16"	53107	11/64"			
53101	5/64"	53108	3/16"			
53102	3/32"	53109	13/64"			
53103	7/64"	53110	7/32"			
53104	1/8"	53111	15/64"			
53105	9/64"	53112	1/4"			
53106	5/32"					



53002

15-Piece Regular-Point Drill-Bit Set

- Hinged metal box with two stand-up bit holders.

Cat. No.	Set Contains				Weight (lbs.)	
53001					2.00	
Cat. No.	Bit Size	Cat. No.	Bit Size			
53100	1/16"	53116	5/16"			
53102	3/32"	53118	11/32"			
53104	1/8"	53120	3/8"			
53106	5/32"	53122	13/32"			
53108	3/16"	53124	7/16"			
53110	7/32"	53126	15/32"			
53112	1/4"	53128	1/2"			
53114	9/32"					



53001

29-Piece Regular-Point Drill-Bit Set

- Hinged metal box with three stand-up bit holders.

Cat. No.	Set Contains				Weight (lbs.)	
53000					3.25	
Cat. No.	Bit Size	Cat. No.	Bit Size			
53100	1/16"	53115	19/64"			
53101	5/64"	53116	5/16"			
53102	3/32"	53117	21/64"			
53103	7/64"	53118	11/32"			
53104	1/8"	53119	23/64"			
53105	9/64"	53120	3/8"			
53106	5/32"	53121	25/64"			
53107	11/64"	53122	13/32"			
53108	3/16"	53123	27/64"			
53109	13/64"	53124	7/16"			
53110	7/32"	53125	29/64"			
53111	15/64"	53126	15/32"			
53112	1/4"	53127	31/64"			
53113	17/64"	53128	1/2"			
53114	9/32"					

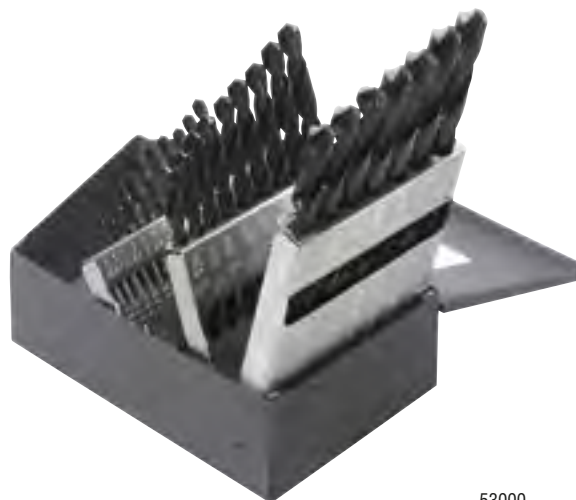

53000

All dimensions are in inches and (millimeters) unless otherwise specified.

NOTE: Read and follow safety instructions in power tool owner's manual.

▲WARNING: Never use on or near live electrical circuits.

▲WARNING: Always ensure that you and persons in the vicinity wear approved eye protection.



Drill Bits

Regular-Point 118° High-Speed Drill Bits

- General-purpose, high-speed bits for reliable performance in a wide range of materials.
- Standard jobber length.
- Black-oxide finish reduces chip welding.
- Lightly roughened surface has higher lubricity for easier chip flow.

Cat. No.	Bit Size	Flute Length	Overall Length	Weight (lbs.)
53100	1/16"	7/8" (22 mm)	1-7/8" (48 mm)	.01
53101	5/64"	1" (25 mm)	2" (51 mm)	.01
53102	3/32"	1-1/4" (32 mm)	2-1/4" (57 mm)	.01
53103	7/64"	1-1/2" (38 mm)	2-5/8" (67 mm)	.01
53104	1/8"	1-5/8" (41 mm)	2-3/4" (70 mm)	.01
53105	9/64"	1-3/4" (44 mm)	2-7/8" (73 mm)	.01
53106	5/32"	2" (51 mm)	3-1/8" (79 mm)	.01
53107	11/64"	2-1/8" (54 mm)	3-1/4" (83 mm)	.01
53108	3/16"	2-5/16" (59 mm)	3-1/2" (89 mm)	.02
53109	13/64"	2-7/16" (62 mm)	3-5/8" (92 mm)	.02
53110	7/32"	2-1/2" (64 mm)	3-3/4" (95 mm)	.05
53111	15/64"	2-5/8" (67 mm)	3-7/8" (98 mm)	.05
53112	1/4"	2-3/4" (70 mm)	4" (102 mm)	.05
53113	17/64"	2-7/8" (73 mm)	4-1/8" (105 mm)	.05
53114	9/32"	2-15/16" (75 mm)	4-1/4" (108 mm)	.05



53128

Cat. No.	Bit Size	Flute Length	Overall Length	Weight (lbs.)
53115	19/64"	3-1/16" (78 mm)	4-3/8" (111 mm)	.05
53116	5/16"	3-3/16" (81 mm)	4-1/2" (114 mm)	.05
53117	21/64"	3-5/16" (84 mm)	4-5/8" (117 mm)	.10
53118	11/32"	3-7/16" (87 mm)	4-3/4" (121 mm)	.05
53119	23/64"	3-1/2" (89 mm)	4-7/8" (124 mm)	.10
53120	3/8"	3-5/8" (92 mm)	5" (127 mm)	.10
53121	25/64"	3-3/4" (95 mm)	5-1/8" (130 mm)	.10
53122	13/32"	3-7/8" (98 mm)	5-1/4" (133 mm)	.15
53123	27/64"	3-15/16" (100 mm)	5-3/8" (137 mm)	.15
53124	7/16"	4-1/16" (103 mm)	5-1/2" (140 mm)	.15
53125	29/64"	4-3/16" (106 mm)	5-5/8" (143 mm)	.18
53126	15/32"	4-5/16" (110 mm)	5-3/4" (146 mm)	.15
53127	31/64"	4-3/8" (111 mm)	5-7/8" (149 mm)	.20
53128	1/2"	4-1/2" (114 mm)	6" (152 mm)	.20

4-Piece, Carbide-Tipped, Masonry Drill Bit Set



53004

- Protective plastic storage pouch.

Cat. No.	Set Contains	Weight (lbs.)
53004		.30

Cat. No.	Bit Size
53175	1/4"
53176	5/16"
53177	3/8"
53178	1/2"

Carbide-Tipped, Masonry Drill Bits



53178

- Drills through hard materials such as brick, concrete, plaster, and tile.
- Black-oxide finish reduces chip welding.

Cat. No.	Bit Size	Shank Diameter	Overall Length	Weight (lbs.)
53175	1/4"	1/4"	4" (102 mm)	.05
53176	5/16"	1/4"	4" (102 mm)	.05
53177	3/8"	1/4"	4" (102 mm)	.05
53178	1/2"	1/4"	4" (102 mm)	.10

Anchors

Conical Anchor Kit – 100 Fasteners

- Kit contains: 100 #2 Phillips, 10 x 1" Screws, and 100 plastic anchors.
- 1/4" Masonry drill bit also included.

Cat. No.	Anchor Size	Screw Size	Bit Size	Weight (lbs.)
53729	10 - 12	10 x 1" (25 mm)	1/4" (6 mm)	1.00



53729

All dimensions are in inches and (millimeters) unless otherwise specified.

NOTE: Read and follow safety instructions in power tool owner's manual.

WARNING: Never use on or near live electrical circuits.

WARNING: Always ensure that you and persons in the vicinity wear approved eye protection.



JOURNEYMAN Aviation SNIPS

Aviation, Offset & Right Angle

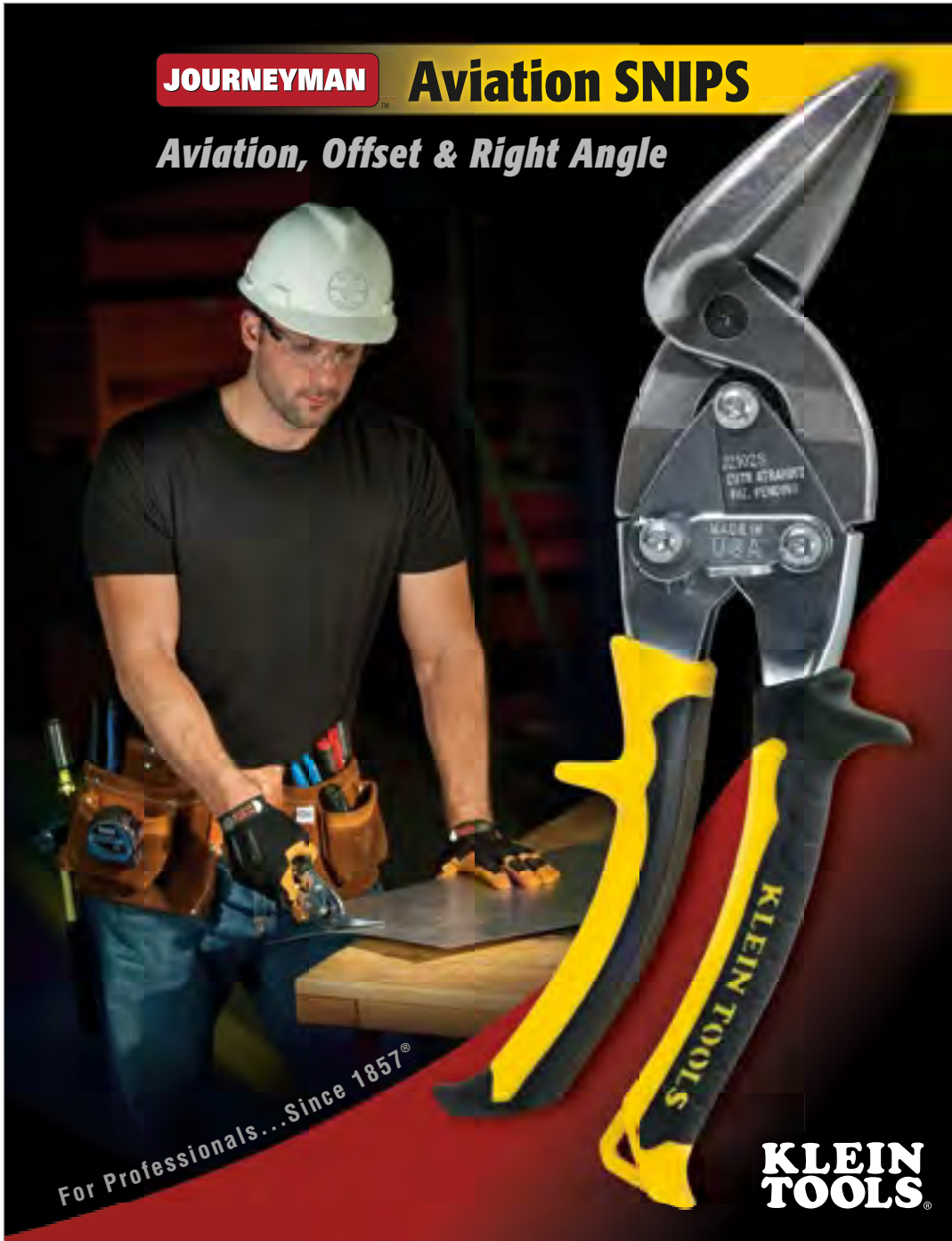

For Professionals... Since 1857®

**KLEIN
TOOLS®**



Saws & Blades

Saws and blades from Klein are designed with the professional user in mind, providing superior results with less effort.

F O R P r o f e s s i o n a l s S i n c e 1 8 5 7 ®



Saws & Blades



Saws & Blades

High-Tension Hack Saw

- Adjustable blade tension up to 30,000 PSI for fast, precise cuts.
- Soft-touch grips.
- Alternative 45 degree mounting for flush cutting.
- Front mount for reciprocating saw blades.
- Blade storage in handle.
- Includes 12" x 24 TPI bi-metal hack saw blade and 6" x 24 TPI reciprocating saw blade.



702-12

Cat. No.	Blade Length	Overall Length	Weight (lbs.)
702-12	12" (305 mm)	16-1/4" (413 mm)	1.45

Heavy-Weight Hacksaws

- A rugged, heavy-duty saw with the versatility to satisfy professional requirements.
- Greater weight means a faster job.
- Permits efficient one-hand use where necessary.
- Blade cuts fully through to a flat surface.
- Converts easily from vertical to horizontal position for full-flush cutting.
- Durable, tubular steel frame and die-cast zinc handles with blue finish.
- Pivot-action front end with slotted tensioning rod permits maximum tightening of blade for more efficient sawing and longer blade life.
- Curved front-end design for comfortable two-hand use.
- Storage for extra blades in tubular steel frame.



701-10

Cat. No.	Blade Length	Overall Length	Weight (lbs.)
701-10	10" (254 mm)	14" (356 mm)	2.05
701-12	12" (305 mm)	16" (406 mm)	2.10

Dual-Purpose Hacksaw — Golden Tri-Cut™ 3-in-1 Blade

- Blade has three teeth sizes.
- Blade converts quickly to 90° or 45° for standard or flush-cut applications.
- Pivot-lock adjusts blade tension for straighter cuts and longer blade life.
- Set screw allows for storage of extra blades and secures blade for "jab" sawing.
- Aluminum finger grip handle and front end.
- Thumb guard for two-hand sawing.



701-S

Cat. No.	Blade Length	Overall Length	Weight (lbs.)
701-S	12" (305 mm)	16" (406 mm)	1.45



Blade has
three teeth
sizes

All dimensions are in inches and (millimeters).

▲WARNING: Always wear approved eye protection.

▲WARNING: Never use on or near live electrical circuits.

Saws & Blades

Bi-Metal Blades

1224BI

- Special high-speed steel teeth fused to regular carbon-steel body, which provides superior cutting and longer life.
- Withstands greater saw tension for less blade flexing.
- Fits all 12" (305 mm) hacksaw blades.
- Blue finish.
- Available in box of 100 blades or in a reclosable, heavy-vinyl, seal-tight pouch of ten blades.

Cat. No.	Pack Size	Teeth Per Inch	Length	Weight Per Pack (lbs.)
1218BI-P	10-pack	18	12" (305 mm)	.45
1224BI-P	10-pack	24	12" (305 mm)	.45
1232BI-P	10-pack	32	12" (305 mm)	.45
1218BI	100-pack	18	12" (305 mm)	4.50
1224BI	100-pack	24	12" (305 mm)	4.50
1232BI	100-pack	32	12" (305 mm)	4.50

Jab Saw

- Cuts drywall, wallboard, plywood and plastic.
- Triple ground teeth for a fast cut.
- Blade cuts in both directions (push and pull).
- Hardened, carbon-steel blade for durability.
- Hardened, beveled blade point for scoring and plunge cuts.
- Comfort cushion grip with thumb groove.
- Handle structure designed for strength and durability.
- Flat-end grip for palming or punching through drywall.



725

Cat. No.	Blade Length	Overall Length	Weight (lbs.)
725	6" (152 mm)	12" (305 mm)	.31

▲WARNING: Never use blade as a prying device as blades may break & cause injury.

Magic-Slot Compass Saws

- Magic-Slot design allows fast blade changing without removing thumbscrew.
- Handle is strong, lightweight, die-cast zinc with blue finish.
- Handle is contoured for comfort.
- Blade is tough, high-quality carbon steel, 8" (203 mm) long, with ten teeth per inch for general-purpose use.
- Replacement blades and handle can be ordered separately.



703

Cat. No.	Description	Overall Length	Teeth Per Inch	Weight (lbs.)
703	Magic-Slot compass saw complete with Cat. No. 706 blade	13" (330 mm)	10	1.20
702	Magic-Slot compass saw handle only. Takes only Magic-Slot cut-in or general-purpose blades.	5" (127 mm)	—	1.10

Compass Saw Blades



709

- For cutting through wallboard or Masonite to install wiring, outlet boxes, etc.
- Tough high-quality carbon steel.
- Pointed starter tip.
- Fits Magic-Slot compass saw handle Cat. No. 702.

Golden Tri-Cut™ Blades

1200BI



Blade has three teeth sizes

- Unique design provides three teeth sizes on one blade.
- Has 32 teeth/inch up front for quick starts, 24 teeth/inch in the middle and 18 teeth/inch on the end for fast and smooth conventional cutting.
- Special high-speed steel teeth fused to carbon-steel provide superior cutting action and long life.
- Gold finish.
- Available in box of 100 blades or reclosable, heavy-vinyl, seal-tight pouch of ten blades.

Cat. No.	Pack Size	Teeth Per Inch	Length	Weight Per Pack (lbs.)
1200BI-P	10-pack	32-24-18	12" (305 mm)	.45
1200BI	100-pack	32-24-18	12" (305 mm)	4.50



All dimensions are in inches and (millimeters).

▲WARNING: Always wear approved eye protection.

▲WARNING: Never use on or near live electrical circuits.

Reciprocating Saw Blades

Premium Reciprocating Saw Blades

- Heavy duty, bi-metal blades are 1" wide and .042 thick, which offers greater rigidity for smooth, straight, accurate cuts.
- Innovative tooth geometry and blade design for faster cutting, less vibration and longer blade life.
- Available in blade lengths of 6", 9" and 12" to meet a variety of cutting applications.
- 1/2" universal shank to fit all popular reciprocating saw tools.



31810

Cat. No.	Blade Length	TPI	Blade Width	Blade Thickness	Pack	Main Applications
31810	6"	10	1"	0.042	5	HD - Metal
31802	6"	14	1"	0.042	5	HD - Metals 1/8" thick & above
31804	6"	18	1"	0.042	5	HD - Metals 18 ga. to 1/8"
31806	6"	24	1"	0.042	5	HD - Metals 18 ga. & under
31808	9"	10	1"	0.042	5	HD - Metal
31832	9"	14	1"	0.042	5	HD - Metals 1/8" thick & above
31834	9"	18	1"	0.042	5	HD - Metals 18 ga. to 1/8"
31836	12"	10	1"	0.042	5	HD - Metal
31838	12"	14	1"	0.042	5	HD - Metals 1/8" thick & above
31840	12"	18	1"	0.042	5	HD - Metals 18 ga. to 1/8"

Reciprocating Saw Blades

- Bi-metal blades in a variety of blade lengths and thicknesses for different cutting applications.
- Shock resistant teeth resist strippage.
- 1/2" universal shank to fit all popular reciprocating saw tools.

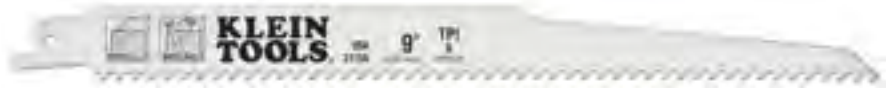

31750



31722

Cat. No.	Blade Length	TPI	Blade Width	Blade Thickness	Pack	Main Applications
31710	6"	6	3/4"	0.035	5	Wood with nails
31710-15	6"	6	3/4"	0.035	15	Wood with nails
31714	6"	6	3/4"	0.035	5	Plaster
31716	6"	6	3/4"	0.050	5	Wood with nails
31716-15	6"	6	3/4"	0.050	15	Wood with nails
31720	6"	10	3/4"	0.035	5	Wood, plastic and non-ferrous
31722	6"	14	3/4"	0.035	5	Heavy ga. metals
31722-15	6"	14	3/4"	0.035	15	Heavy ga. metals
31722-50	6"	14	3/4"	0.035	50	Heavy ga. metals
31728	6"	18	3/4"	0.035	5	Heavy ga. metals
31728-15	6"	18	3/4"	0.035	15	Heavy ga. metals
31728-50	6"	18	3/4"	0.035	50	Heavy ga. metals
31734	6"	24	3/4"	0.035	5	18 ga. and under
31734-15	6"	24	3/4"	0.035	15	18 ga. and under

Cat. No.	Blade Length	TPI	Blade Width	Blade Thickness	Pack	Main Applications
31738	8"	10/14	3/4"	0.035	5	Wood with nails
31738-15	8"	10/14	3/4"	0.035	15	Wood with nails
31742	8"	14	3/4"	0.035	5	Heavy ga. metals
31742-15	8"	14	3/4"	0.035	15	Heavy ga. metals
31746	8"	18	3/4"	0.035	5	Heavy ga. metals
31746-15	8"	18	3/4"	0.035	15	Heavy ga. metals
31750	9"	6	3/4"	0.050	5	Wood with nails
31750-15	9"	6	3/4"	0.050	15	Wood with nails
31754	9"	6	7/8"	0.062	3	Demo
31756	9"	10	7/8"	0.062	3	Demo
31758	12"	6	3/4"	0.050	5	Wood with nails
31758-15	12"	6	3/4"	0.050	15	Wood with nails
31762	12"	6	7/8"	0.062	3	Demo
31764	12"	10	7/8"	0.062	3	Demo
31766	12"	10/14	3/4"	0.050	5	Wood with nails

All dimensions are in inches and (millimeters).

▲WARNING: Always wear approved eye protection.

▲WARNING: Never use on or near live electrical circuits.



Knives & Cutting Tools

Klein provides a wide range of knives, scissors and other cutting tools for professional applications across all trades.

F O R P R O F E S S I O N A L S S I N C E 1 8 5 7 ®

Knives & Cutting Tools



Pocket Knives – One Blade

Lightweight Lockback Knives

- Blades are AUS 8 stainless steel hardened to 58-59 Rc.
- Premium quality blade offers superior edge holding.
- Impact-resistant nylon resin handle with rubber insert (Cat. Nos. 44002-44005).
- Slim and comfortable silver anodized-aluminum handle for corrosion-resistance (Cat. Nos. 44000, 44001, 44006, 44007).
- Black chrome blade and black anodized-aluminum handle for corrosion-resistance (Cat. Nos. 44000-BLK and 44001-BLK).
- Reversible thumb stud provides easy one-handed opening.

Cat. No.	Blade Steel	Blade Length	Length Closed	Weight (oz.)
Drop Point Blade				
44000	AUS 8 stainless steel	2-1/4" (57 mm)	3-1/8" (76 mm)	1.5
44000-BLK	AUS 8 stainless steel	2-1/4" (57 mm)	3-1/8" (76 mm)	1.1
44001*	AUS 8 stainless steel	2-1/2" (64 mm)	3-1/2" (89 mm)	2.5
44001-BLK*	AUS 8 stainless steel	2-1/2" (64 mm)	3-1/2" (89 mm)	1.3
44002	AUS 8 stainless steel	2-3/8" (60 mm)	3-1/2" (89 mm)	1.5
44003	AUS 8 stainless steel	2-3/4" (70 mm)	4-1/8" (105 mm)	2.5
Sheepfoot Blade				
44004	AUS 8 stainless steel	2-3/8" (60 mm)	3-1/2" (89 mm)	1.5
44005	AUS 8 stainless steel	2-5/8" (67 mm)	4-1/8" (105 mm)	2.5
44006*	AUS 8 stainless steel	2-5/8" (67 mm)	3-1/2" (89 mm)	1.3
Coping Blade				
44007*	AUS 8 stainless steel	2-1/2" (63 mm)	3-1/2" (89 mm)	1.5

* Includes a pocket/belt clip.



44001-BLK



44001



44002



44005

Money-Clip Pocket Knife – Spearpoint Blade and Nail File

- Handsome, brushed stainless steel case with rosewood insert.
- Includes money clip, 1-1/2" (38 mm) spearpoint blade and 1-1/2" (38 mm) nail file.

Cat. No.	Blade Type	Blade Length	Length Closed	Weight (oz.)
44031	stainless steel	1-1/2" (38 mm)	2-1/8" x 7/8" x 1/4" (54 mm x 22 mm x 6 mm)	.80



44031

All dimensions are in inches and (millimeters).

▲WARNING: Always wear approved eye protection.

▲WARNING: Never use on or near live electrical circuits.



Pocket Knives – One Blade

Compact Pocket Knives – Drop Point Blade

- Compact and lightweight knives.
- Stainless steel handles and blades for long life.



44033

- Rosewood handle inserts on both sides.
- Modified spearpoint blades lock open.

Cat. No.	Blade Steel	Blade Length	Length Closed	Weight (oz.)
44032	stainless steel	1-5/8" (41 mm)	2-1/2" (64 mm)	1.0
44033	stainless steel	2" (51 mm)	3" (76 mm)	1.8
44034	stainless steel	2-5/8" (67 mm)	4" (102 mm)	4.0

Sportsman Knives – Drop Point Blade

- Curved handle with big bolster.
- Brass bolsters and ebony wood handles.
- Stainless steel blades for long life.
- Brass linings.



44037

- Blade locks open.
- Cat. No. 44037 furnished with leather snap case with belt loop.

Cat. No.	Blade Steel	Blade Length	Length Closed	Weight (oz.)
44035	stainless steel	2" (51 mm)	3" (76 mm)	1.5
44036	stainless steel	2-3/8" (60 mm)	3-1/2" (89 mm)	2.5
44037	stainless steel	3-3/8" (86 mm)	4-7/8" (124 mm)	6.5

Pocket Knives – Coping Blade

- Coping-type blade.
- Compact and lightweight.
- Ideal for skinning small wire and cable.

Cat. No.	Blade Steel	Blade Length	Length Closed	Weight (oz.)
1550-5	carbon steel	2-1/4" (57mm)	3-1/4" (83mm)	1.5
1550-11*	carbon steel	2-1/4" (57mm)	3-1/4" (83mm)	1.5
1550-14*	carbon steel	3" (76mm)	4-1/4" (108mm)	4.0
1550-45	stainless steel	2-1/4" (57mm)	3-1/4" (83mm)	1.5

*Blade locks open



1550-11

Pocket Knives – Sheepfoot Slitting Blade

- Extra-large curved sheepfoot slitting-blade – 2-5/8" (67 mm) long.
- Ideal for heavy-duty line work.
- Woodgrain plastic handle.
- Blade locks open.



1550-4

Cat. No.	Blade Steel	Blade Length	Length Closed	Weight (oz.)
1550-4	carbon steel	2-5/8" (67 mm)	4" (102 mm)	4.0
1550-44	stainless steel	2-5/8" (67 mm)	4" (102 mm)	4.0

Pocket Knife – Slitting Blade

- Large, stainless steel, curved-sheepfoot slitting blade – 2-1/2" (64 mm) long.
- Ideal for heavy-duty line work.
- Plastic handle.
- Blade locks open.



1550-24

Cat. No.	Blade Steel	Blade Length	Length Closed	Weight (oz.)
1550-24	stainless steel	2-1/2" (64 mm)	4-3/8" (111 mm)	2.5

All dimensions are in inches and (millimeters).

▲WARNING: Always wear approved eye protection.

▲WARNING: Never use on or near live electrical circuits.



Pocket Knives – Two Blades

2-Blade Pocket Knives – Spearpoint and Screwdriver-Tip Blades



- Standard spearpoint blade – 2-1/2" (64 mm) long.
- Screwdriver-tip blade – 2-1/2" (64 mm) long.
- Screwdriver-tip blade locks open.

Cat. No.	Blade Steel	Blade Lengths	Length Closed	Weight (oz.)
1550-2	carbon steel	2-1/2" (64 mm)	3-3/4" (95 mm)	4.0
1550-42	stainless steel	2-1/2" (64 mm)	3-3/4" (95 mm)	4.0

2-Blade Pocket Knife – Sheepfoot and Screwdriver-Tip Blades



- Curved sheepfoot slitting blade – 2-3/8" (60 mm) long.
- Screwdriver-tip blade – 2-1/2" (64 mm) long.
- Screwdriver blade locks open.

Cat. No.	Blade Steel	Blade Lengths	Length Closed	Weight (oz.)
1550-7	carbon steel	2-3/8" (60 mm) and 2-1/2" (64 mm)	3-3/4" (95 mm)	4.0

2-Blade Pocket Knife – Sheepfoot and Insulation-Slitting Blades

- Curved sheepfoot skinning blade – 2-3/8" (60 mm) long.
- Special insulation-slitting blade – 1-1/2" (38 mm) long.
- Slitting blade locks open.

Cat. No.	Blade Steel	Blade Lengths	Length Closed	Weight (oz.)
1550-10	carbon steel	2-3/8" (60 mm) and 1-1/2" (38 mm)	3-3/4" (95 mm)	4.0



1550-7

Pocket Knives – Three Blades

3-Blade Pocket Knife – Sheepfoot, Spearpoint and Screwdriver-Tip Blades

- Curved sheepfoot skinning blade – 2-3/8" (60 mm) long.



- Standard spearpoint blade – 2-1/2" (64 mm) long.
- Screwdriver-tip blade – 2-1/2" (64 mm) long.
- Screwdriver blade locks open.

Cat. No.	Blade Steel	Blade Lengths	Length Closed	Weight (oz.)
1550-6	carbon steel	2-3/8" (60 mm), 2-1/2" (64 mm), 2-1/2" (64 mm)	3-3/4" (95 mm)	5.0

3-Blade Pocket Knife – Spearpoint, Insulation-Slitting and Screwdriver-Tip Blades



- Spearpoint blade – 2-1/2" (64 mm) long.
- Special insulation-slitting blade – 1-1/2" (38 mm) long.
- Screwdriver-tip blade – 2-1/2" (64 mm) long.
- Both slitting blade and screwdriver-tip blade lock open.

Cat. No.	Blade Steel	Blade Lengths	Length Closed	Weight (oz.)
1550-9	carbon steel	2-1/2" (64 mm), 1-1/2" (38 mm), 2-1/2" (64 mm)	3-3/4" (95 mm)	5.0

All dimensions are in inches and (millimeters).

▲WARNING: Always wear approved eye protection.

▲WARNING: Never use on or near live electrical circuits.



Sharpening Tools

Pocket-Sized Knife Sharpener

- A rugged, versatile sharpener featuring fine craftsmanship and unique design.
- Blade unscrews and stores in handle for convenient carrying in tool box, pouch, or pocket.
- Blade is precision-cut, hard-chromed steel for accurate, consistent sharpening and long life.
- Magnetized to trap metal particles when sharpening.
- Handle is a high-visibility orange color with handy pocket clip.



44151

Cat. No.	Blade Length	Length Closed	Weight (lbs.)
44151	3-3/4" (95 mm)	5-1/2" (140 mm)	.05

Combination Knife and Scissors Sharpener

- High-grade, tungsten-carbide inserts sharpen both sides of the blade at the same time.
- Restores knife edge in three or four strokes.
- Built-in finger guard helps to protect your hand.
- Lightweight, compact size for easy carrying and storage.
- Sharpens electrician's scissors, pocket knives, retractable-blade utility knives, razor blade knives and serrated knives.



48036

Cat. No.	Overall Size	Weight (lbs.)
48036	4" L x 2-1/4" W x 3/4" D (102 mm x 57 mm x 19 mm)	.10

⚠WARNING: Improper use of knife and scissors sharpener and/or failure to follow instructions can result in injuries. Keep your fingers behind the curved guard and your thumb securely on the multi-grooved thumb-rest indentation, never in front of it.

Utility Knives

Utility Knife — Retractable Blade

- Top button moves heavy-duty, razor-edged blade to any of three cutting positions.
- Double-ended, reversible blade retracts fully for carrying.
- Lightweight aluminum handle is shaped for comfort.
- Accepts most standard blades.
- Includes three standard blades, stored in handle.
- Blades made in the U.S.A.
- Leather holder available, Cat. No. 5185.



44100

Cat. No.	Length Closed	Weight (lbs.)
44100	6" (152 mm)	.22

Utility Knife Blades

- Heavy-duty razor-edged blades.
- Universal size fits Klein and most other makes of utility knives.
- Blades are reversible for extra life.
- Blades made in the U.S.A.

Cat. No.	Blade Size	Package Size	Weight (lbs.)
44101	2-7/16" x .025" (62 mm x 6 mm)	5 blades	.05
44104	2-7/16" x .025" (62 mm x 6 mm)	bulk package of 400 blades	4.0

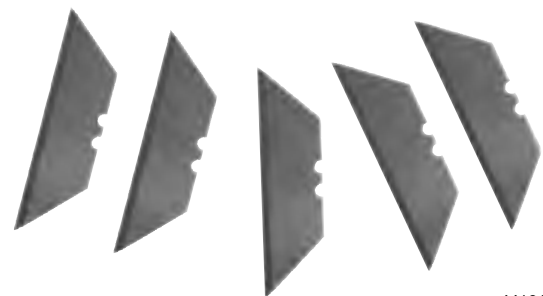

44101

All dimensions are in inches and (millimeters).

⚠WARNING: Always wear approved eye protection.

⚠WARNING: Never use on or near live electrical circuits.



Utility Knives

Auto Loading Folding Retractable Utility Knife



44130

- Auto-loading blade for faster and safer blade changes.
- High quality triple ground blades stay sharp longer.
- Quick release button for easy blade change.
- Heavy-duty, durable construction.
- Rubber grips on handle for improved control and comfort.
- Internal blade storage holds and includes 3 blades.



Cat. No.	Length Closed	Overall Length w/Blade	Weight
44130	4.25" (108 mm)	6.625" (168.3 mm)	.47 lbs. (0.21 kg)

Auto Loading Retractable Utility Knife



44132

- Auto-loading blade for faster and safer blade changes.
- High quality triple ground blades stay sharp longer.
- Quick release button for easy blade change.
- Heavy-duty, durable construction.
- Rubber grips on handle for improved control and comfort.
- Internal blade storage holds and includes 3 blades.

Cat. No.	Length Closed	Overall Length w/Blade	Weight
44132	6.25" (158.8 mm)	N/A	.48 lbs. (0.22 kg)

Folding Utility Knife



44131

- Push button to easily open and close.
- High quality triple ground blades stay sharp longer.
- Rubber grips on handle for improved control and comfort.
- Heavy-duty, durable construction.

Cat. No.	Length Closed	Overall Length w/Blade	Weight
44131	4.125" (104.8 mm)	4.50" (114.3 mm)	.27 lbs. (0.12 kg)

Klein Kurve® Retractable Utility Knife



44133

- Designed for improved comfort & cutting ability.
- High quality triple ground blades stay sharp longer.
- Quick release button for easy blade change.
- Heavy-duty, durable construction.
- Rubber grips on handle for improved control and comfort.
- Includes 6 blades.



Cat. No.	Length Closed	Overall Length w/Blade	Weight
44133	6.875" (174.6 mm)	N/A	.47 lbs. (0.21 kg)

Utility Knife Blade Dispenser



44103

- 50 blades included.
- High quality triple ground blades stay sharp longer.
- Gauge on dispenser indicates blades remaining.
- Convenient interim storage for used blades.
- Blades are compatible with all standard utility knives.

Cat. No.	Dimensions	Weight
44103	4.33" x 2.80" x 1.30" (71 mm x 32 mm x 110 mm)	1 lb. (0.45 kg)

All dimensions are in inches and (millimeters).

⚠WARNING: Always wear approved eye protection.

⚠WARNING: Never use on or near live electrical circuits.

⚠WARNING: Blades are intended for cutting only, and should be handled and disposed of with care. Bending the blade can cause it to break, possibly resulting in bodily injury.



Special-Purpose Knives

Cable-Sheath Splitting Knife



1515-S

- Compact, lightweight knife for opening lead cables.
- Rugged, forged tempered cutlery steel blade.
- Sharp, chisel-shaped edge.
- Hammer head on back.
- Plastic-dipped handle for comfort.
- Leather guard available, Cat. No. 5574S.

Cat. No.	Overall Length	Blade Length	Weight (lbs.)
1515-S	7-3/8" (187 mm)	2-19/32" (66 mm)	.35

Cable/Lineman's Skinning Knives



1570-3

- Three-inch steel blade withstands frequent scoring and slitting of cable jacket.
- Blade and ring are securely molded in handle.
- Notch on blade back for scraping or removing wire insulation.
- Comfortable textured handle with finger grooves and guard.
- No contact between stainless steel ring and hardened steel blade (Cat. No. 1570-3).
- Rectangle-shaped handle design for attachment to some utility hot stick equipment.
- Leather sheath available, Cat. No. 5163.

Cat. No.	Description	Handle Color	Length Less Ring	Weight (lbs.)
1570-3	hook blade, notch, and ring	black	8" (203 mm)	.30
1570-3LR	hook blade and notch	black	8" (203 mm)	.29

Cable-Splicer's Knife



44200

- Special-purpose short blade with comfortable, full-sized, heavy-duty handle.
- Coping-type blade made of the finest cutlery steel, tough and carefully tempered to hold its edge.
- Handle is textured for comfort and firm grip.
- Hang hole for easy storage and portability.

Cat. No.	Overall Length	Blade Length	Weight (lbs.)
44200	6-1/4" (159 mm)	1-3/4" (44 mm)	.15

All dimensions are in inches and (millimeters).

▲WARNING: Always wear approved eye protection.

Bell System Cable-Sheath Splitting Knife — Heavy-Duty



1515-1

- Heavy-duty knife for splitting cable sheaths.
- Rugged, forged tempered cutlery steel blade.
- Sharp chisel-shaped edge.
- Plastic-dipped handle for comfort.
- Leather guard available, Cat. No. 5574L.

Cat. No.	Overall Length	Blade Length	Weight (lbs.)
1515-1	8-3/4" (222 mm)	4-1/2" (114 mm)	1.20

Cable-Splicer's Kits



46037

- Cuts cable, telephone wire, and strips insulation.
- Dimensions: 2-1/8" x 7-1/2" (54 mm x 191 mm).

Cat. No.	Kit Contains	Weight (lbs.)
46037	cable splicer's kit	.50

Cat. No.	Description
44200	cable-splicer's knife
2100-7	electrician's scissors with stripping notches
5187	slotted leather holder for belts up to 2" (51 mm) wide

Cat. No.	Kit Contains	Weight (lbs.)
46039	cable splicer's kit - with free-fall snip	.58

Cat. No.	Description
44200	cable-splicer's knife
2101-0	free-fall snip
5187	slotted leather holder for belts up to 2" (51 mm) wide



▲WARNING: Never use on or near live electrical circuits.

▲WARNING: NOT insulated. Will NOT protect against electrical shock.

Electrician's Scissors

Electrician's Scissors



2100-5

- Designed for telecom and electrical applications and heavy-duty use.
- Strong, tough tempered steel.
- Nickel-plated finish resists corrosion.
- Scraper and file on outside of both blades.

Cat. No.	Overall Length	Cutting Length	Weight (lbs.)
2100-5	5-1/4" (133 mm)	1-7/8" (48 mm)	.20

Electrician's Scissors – Stripping Notches



2100-7

- Upper blade has notches for stripping 19 AWG and 23 AWG wire.
- Designed for telecom and electrical applications and heavy-duty use.
- Strong, tough tempered steel.
- Nickel-plated finish resists corrosion.
- Scraper and file on outside of both blades.
- Serrated, lower blade reduces slippage.

Cat. No.	Overall Length	Cutting Length	Weight (lbs.)
2100-7	5-1/4" (133 mm)	1-7/8" (48 mm)	.20

Stainless Steel Electrician's Scissors – Stripping Notches



2100-9



2100-8

- Stainless steel blades to maintain blade durability and sharpness.
- Blade is fully serrated for non-slip cutting action.
- Free-fall snip feature for ease of use (2100-8).
- Cuts electrical communication 19 AWG and 23 AWG wire.
- Extended handle provides comfort and cutting leverage for wire cutting application (2100-8).
- 56 HRC.

Cat. No.	Overall Length	Cutting Length	Weight (lbs.)
2100-8	6-5/16" (160 mm)	1-7/8" (48 mm)	.21
2100-9	5-1/4" (133 mm)	1-7/8" (48 mm)	.21

Industrial High-Leverage Shears

High-Leverage Snip



22000

- Nickel chrome plating resists corrosion and rusting.
- Broad, short jaws provide powerful cutting action (22001, 22002).
- One blade is serrated for non-slip cutting action (22001, 22002).
- Extended handle provides comfort and cutting leverage (22002, 22003).
- High-leverage provides powerful cutting action for light metals, rubber and heavy fabrics (22000, 22003).
- Cuts light wire, fabric, cable and cordage (22001).
- Cuts rubber, cables, light metal, wire metal screens, cordage, plastics and ropes (22002).

Cat. No.	Overall Length	Cutting Length	Weight (lbs.)
22000	7" (180 mm)	1-3/4" (45 mm)	.34
22001	8" (203 mm)	2" (51 mm)	.55
22002	8-1/2" (216 mm)	2" (51 mm)	.55
22003	9" (229 mm)	3" (76 mm)	.49

Large Broad Blade Utility Shear



22002

Broad Blade Utility Shear



22001

8" High-Leverage Utility Shear



22003

All dimensions are in inches and (millimeters).

▲WARNING: Always wear approved eye protection.

▲WARNING: Never use on or near live electrical circuits.



Industrial Utility Snips

High-Leverage Kevlar® Snip

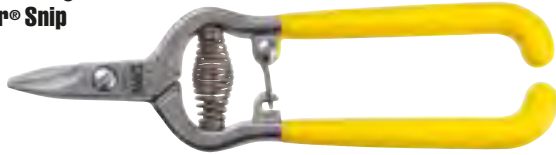

24000

- Nickel chrome plating resists corrosion and rusting.
- One blade is serrated for non-slip cutting action.
- Spring loaded for self-opening action.
- Handy closure lock for convenient storage (24000, 24001).
- Compatible for right- and left-handed users.
- Excellent for cutting Kevlar® insulation in fiber optic applications (24000, 24001).
- Excellent for cutting electronics and filaments (24005).

Kevlar® is a registered trademark of E.I. du Pont de Nemours and Company.

Spring Action Snip



24001

5" Electronic Filament Snip

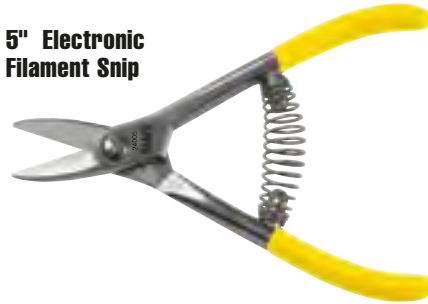

24005

Cat. No.	Overall Length	Cutting Length	Weight (lbs.)
24000	6-1/2" (165 mm)	5/8" (16 mm)	.28
24001	6-1/2" (165 mm)	1" (25 mm)	.28
24005	5" (127 mm)	1" (25 mm)	.22

Bent Trimmers

8" Bent Trimmer

- Cuts plastic, rubber, rubber roofing, roofing materials, cording, vinyl, fiberglass components and cloth materials.



23008

Features:

- Nickel-chrome plating resists corrosion and rusting.
- Extended handle provides comfort and cutting leverage.



23010

10" Bent Trimmer

- Cuts plastic, rubber, rubber roofing, roofing materials, cording, vinyl, fiberglass insulation and cloth materials.

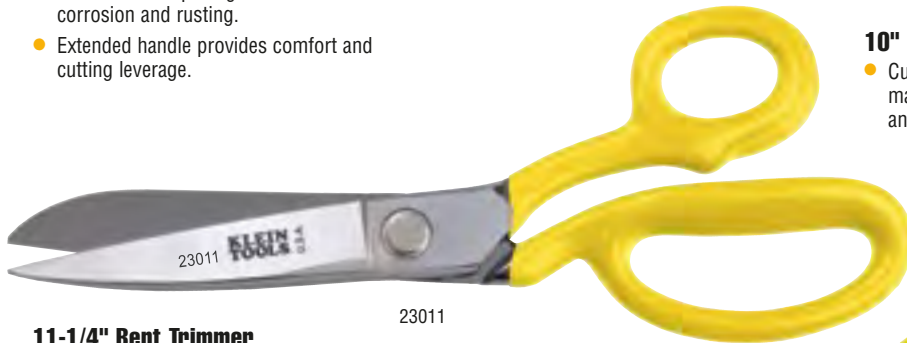

23011

11-1/4" Bent Trimmer

- Cuts felt lining, muslin, cord, rubber, abrasive materials and multiple layers of fabric.



23015

Single Serrated Blunt Blade Shear

- Cuts belting, abrasive belting, heavy fabric, leather, upholstery and heavy carpet.
- Deep serrated blade for non-slip cutting action.

Cat. No.	Overall Length	Cutting Length	Weight (lbs.)
23008	9" (229 mm)	3-1/2" (89 mm)	.41
23010	10-1/2" (267 mm)	4-1/2" (114 mm)	.99
23011	11-1/4" (286 mm)	4-3/4" (121 mm)	1.24
23015	9-3/4" (248 mm)	3-3/16" (81 mm)	.94

All dimensions are in inches and (millimeters).

WARNING: Always wear approved eye protection.

WARNING: Never use on or near live electrical circuits.



Hammers, Chisels & Punches

Klein hammers, chisels and punches are designed and created to strike through jobsite challenges. Engineered with the professional in mind, each tool is job-matched to fit the task at hand.

For Professionals... Since 1857®



Hammers

Electrician's Straight-Claw Hammer



- Durable plastic-alloy jacketing helps to protect neck from fraying and splintering if incorrectly struck or overstruck.
- High-strength fiberglass shaft absorbs shock and keeps head tight.
- Comfortable, perforated neoprene grip bonded to handle.
- Extra-long neck and narrow striking face are ideal for reaching into outlet boxes and other tight areas.
- Balanced and designed specifically for use in electrical work.

807-18

Cat. No.	Head Weight	Overall Length	Weight (lbs.)
807-18	18 oz. (510 g)	15" (381 mm)	1.85

Curved-Claw Hammers — Heavy-Duty



- Durable plastic-alloy jacketing helps to protect neck from fraying and splintering if incorrectly struck or overstruck.
- High-strength fiberglass shaft absorbs shock and keeps head tight.
- Comfortable, perforated neoprene grip bonded to handle.
- Curved claw gives maximum nail-pulling leverage.

818-16

Cat. No.	Head Weight	Overall Length	Weight (lbs.)
818-16	16 oz. (454 g)	13" (330 mm)	1.85
818-20	20 oz. (567 g)	14" (356 mm)	2.00

Lineman's Straight-Claw Hammer



832-32

- Heavy-duty, double-duty hammer drives lags and pulls large nails.
- Special high-carbon steel head with solid, octagon-shaped driving end and thick, strong claw.
- Straight-grain hickory handle, lacquered to withstand weather.

Cat. No.	Head Weight	Overall Length	Weight (lbs.)
832-32	32 oz. (907 g)	15" (381 mm)	2.50

Straight-Claw Hammers — Heavy-Duty



808-16

- Durable plastic-alloy jacketing helps to protect neck from fraying and splintering if incorrectly struck or overstruck.
- High-strength fiberglass shaft absorbs shock and keeps head tight.
- Comfortable, perforated neoprene grip bonded to handle.
- Straight-claw design for easy nail pulling in tight quarters.

Cat. No.	Head Weight	Overall Length	Weight (lbs.)
808-16	16 oz. (454 g)	13" (330 mm)	1.85
808-20	20 oz. (567 g)	14" (356 mm)	2.00

Ball-Peen Hammers



803-12

- Forged high-carbon steel head is hardened for additional durability.
- Crowned face with uniform bevel.
- Smoothly rounded peen.
- Straight-grain hickory handle is stained and lacquered to withstand weather.

Cat. No.	Head Weight	Overall Length	Weight (lbs.)
803-8	8 oz. (227 g)	11-1/2" (292 mm)	.75
803-12	12 oz. (340 g)	12-1/2" (318 mm)	1.10
803-16	16 oz. (454 g)	13-1/2" (343 mm)	1.40
803-24	24 oz. (680 g)	15" (381 mm)	1.90
803-32	32 oz. (907 g)	15" (381 mm)	2.50

Hand-Drilling Hammer



823-48

- Extra-heavy, forged steel head, hardened and tempered.
- Short handle for working in close quarters.
- Select hickory handle, triple-wedged and lacquered to withstand weather.
- Special handle treatment removes handle moisture and replaces it with oil to help eliminate the effects of extreme temperatures.

Cat. No.	Head Weight	Overall Length	Weight (lbs.)
823-48	48 oz. (1361 g)	10" (254 mm)	3.25

All dimensions are in inches and (millimeters) unless otherwise specified.

For Sledge, Brass, Copper + Normalized Hammers, see Mining Tools section

⚠WARNING: Always wear approved eye protection.



Hammers

Lineman's Double-Face Hammer



809-36

- Designed for pole-line work.
- Rugged and well-balanced, with the weight to drive lag bolts.
- Forged, tempered-steel head is only 3-3/4" (95 mm) long for use in tight areas.
- Identical faces with 1-3/4" (44 mm) round-crown driving surface and beveled edges.

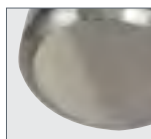

both sides

Cat. No.	Head Weight	Overall Length	Weight (lbs.)
809-36	36 oz. (1021 g)	14" (356 mm)	2.50

Setting Hammer



820-16

- Durable epoxy resin handle helps to protect neck from fraying and splintering if incorrectly struck or over struck.
- High-strength fiberglass shaft absorbs shock and keeps head tight.
- Cushioned, PVC grip bonded to handle.
- Special high-carbon steel, octagon-shaped head with flat striking surface and rounded cross peen.

Cat. No.	Head Weight	Overall Length	Weight (lbs.)
820-16	16 oz. (454 g)	13" (330 mm)	1.6

Dead Blow Hammers



811-16



When struck, the shot directs the striking power and increases the impact, creating a dead blow effect. The reduced rebound upon impact transfers full energy of the blow to the object being struck.

Lineman's Milled-Face Hammer



809-36MF

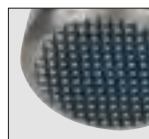

side 1

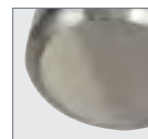

side 2

- One milled face for driving staples used in pole-line work and common, unhardened nails.
- Other face is smooth for driving heavier duty hardware.
- Rugged and well-balanced, with the weight to drive lag bolts.
- Forged, tempered-steel head is only 3-3/4" (95 mm) long for use in tight areas.

Cat. No.	Head Weight	Overall Length	Weight (lbs.)
809-36MF	36 oz. (1021 g)	14" (356 mm)	2.50

Riveting Hammer



821-12

- Forged high-carbon steel round head is hardened for additional durability.
- Flat striking surface with rounded cross peen.
- Straight-grain American hickory handle is stained and lacquered.

Cat. No.	Head Weight	Overall Length	Weight (lbs.)
821-12	12 oz. (340 g)	12-1/4" (311 mm)	1.1

- Durable, abrasion resistant non-marring hammer face.
- Increased striking force with zero impact rebound.
- Design isolates user from striking impact and reduces fatigue.
- 40% more driving power than other dead blow hammers.
- Protects job surface from damage.
- Applications: HVAC, metal fabrication, electronics, oil and mining, wood and metal assembly, automotive, aerospace.

Cat. No.	Head Weight	Overall Length	Weight (lbs.)
811-16	16 oz. (454 g)	12.5" (318 mm)	1.44
811-32	32 oz. (908 g)	18" (457 mm)	1.8

All dimensions are in inches and (millimeters) unless otherwise specified.

For Sledge, Brass, Copper + Normalized Hammers, see Mining Tools section

⚠WARNING: Always wear approved eye protection.



Chisels

Cold Chisels



66142

- Heat-treated, high-carbon steel for necessary hardness and durability.
- Cuts, shapes and removes metal.
- Corrosion-resistant black finish.

Cat. No.	Blade Width	Overall Length	Weight (lbs.)
66140	3/8" (10 mm)	5" (127 mm)	.10
66142	1/2" (13 mm)	6" (152 mm)	.20
66143	5/8" (16 mm)	6-1/2" (165 mm)	.35
66144	3/4" (19 mm)	7-1/2" (191 mm)	.60
66145	7/8" (22 mm)	8" (203 mm)	.85
66146	1" (25 mm)	8-1/2" (216 mm)	1.31

Electrician's Chisel



66100

- One-piece handle and blade forged of strong alloy steel.
- Corrosion-resistant black finish extends to the polished blade edge.

Cat. No.	Blade Width	Overall Length	Weight (lbs.)
66100	2-3/4" (70 mm)	8" (203 mm)	1.10

Center Punches



66313

- High-carbon steel for durability.
- Rugged design for impact strength.
- Smooth-ground points heat-treated to stay sharp and true longer.
- Corrosion-resistant black finish.

Cat. No.	Shank Diameter	Overall Length	Weight (lbs.)
66310	1/4" (6 mm)	4 1/4" (108 mm)	.05
66311	5/16" (8 mm)	4 1/2" (114 mm)	.10
66312	3/8" (10 mm)	5" (127 mm)	.10
66313	1/2" (13 mm)	6" (152 mm)	.25

Cold Chisels — Long-Length



66177

- Heat-treated, high-carbon steel for necessary hardness and durability.
- Cuts, shapes and removes metal.
- Accurately ground edge and long length work better in hard-to-reach areas.
- Corrosion-resistant black finish.

Cat. No.	Blade Width	Overall Length	Weight (lbs.)
66174	1/2" (13 mm)	12" (305 mm)	.40
66177	3/4" (19 mm)	12" (305 mm)	1.05
66183	1" (25 mm)	12" (305 mm)	2.05

Punches

Drift Punches



66343

- High-carbon steel for durability.
- Rugged design for impact strength.
- Strong, heat-treated points are smooth and precision tapered. Corrosion-resistant black finish.

Cat. No.	Point	Taper	Overall Length	Weight (lbs.)
66340	1/8" (3 mm)	4-1/4" (108 mm)	8" (203 mm)	.20
66342	3/16" (5 mm)	5" (127 mm)	9" (229 mm)	.35
66343	1/4" (6 mm)	5-1/2" (140 mm)	11" (279 mm)	.75
66344	5/16" (8 mm)	5-1/2" (140 mm)	11" (279 mm)	.75

Pin Punches



66324

- High-carbon steel for durability.
- Precision-ground shank.
- Heat-treated for added strength and hardness at working end.
- Corrosion-resistant black finish.

Cat. No.	Point Diameter	Overall Length	Weight (lbs.)
66320	1/16" (1.5 mm)	4-1/4" (108 mm)	.05
66321	3/32" (2 mm)	4-3/4" (121 mm)	.10
66322	1/8" (3 mm)	5" (127 mm)	.10
66323	5/32" (4 mm)	5-1/4" (133 mm)	.10
66324	3/16" (5 mm)	5-1/2" (140 mm)	.10
66325	1/4" (6 mm)	7" (178 mm)	.20

All dimensions are in inches and (millimeters) unless otherwise specified.

For additional Chisels and Punches, see Mining Tools section

⚠WARNING: Always wear approved eye protection.



Electrical Test & Measurement

Crafted for optimum durability, reliability and functionality, our innovative line of test and measurement equipment is engineered with the user in mind. Designed for, and by electricians, our electrical testers provide the latest in innovative, time-saving features that professionals require.

For Professionals... Since 1857®



Multimeters

USA Made Professional Series Multimeters

- True RMS for accurate readings of all signals.
- Low impedance reduces ghost voltage.
- Enhanced basic DC accuracy.
- Bar graph responds quickly to changes in measurement.



Made in USA of US and imported parts.



Additional Features for Cat. No. MM6000

- Max / Min / Relative reading for quick troubleshooting in the field.
- Measures frequency, duty cycle, temperature, and capacitance.
- Lead warning indicates when test leads are not properly connected.

*A NIST certified product is guaranteed to have been specially tested to ensure its accuracy. NIST certified meters are special order (lead time: 7 business days). NIST certifications are good for one year from the date of calibration.



Suggested accessories for Cat. Nos. MM5000 & MM6000

- Magnetic hanger kit (Cat. No. 69190)

Measurement		MM5000/ MM5000N* Electrician's TRMS Multimeter	MM6000/ MM6000N* Electrician's / HVAC TRMS Multimeter
AC Current		—	10A
DC Current		—	10A
AC Voltage		1000V	1000V
DC Voltage		1000V	1000V
Audible Continuity		•	•
Resistance Range		40MΩ	50MΩ
Data Hold	HOLD	•	•
Diode Test		•	•
Protective Boot		•	•
Lead Storage		•	•
Auto Power Off	Apo	•	•
Back Light		•	•
Auto Ranging	AUTO	•	•
Temperature	°F °C	—	-58~1832°F -50~1000°C
uA Setting		•	•
Capacitance		—	6000µF
Range Hold	RANGE	•	•
Frequency	Hz	—	399.9kHz
Max/Min	MAX/MIN	•	•
Duty Cycle	%	—	•
Relative Reading		—	•
Optional Hanger Kit		•	•
Bar Graph		•	•
Lead Warning		—	•
Auto Hold	A-HOLD	•	•
True RMS	TRMS	•	•
Low Impedance	LOW Z	•	•
Ingress Protection		IP40	IP20
Drop Protection		3m (10 ft)	3m (10 ft)
Safety Rating		CAT IV 600V	CAT IV 600V
Basic DC Accuracy		±0.3%	±0.2%
Counts	00.00	4000	6000
Listings			



All dimensions are in inches and (millimeters).

Multimeters

Professional Series Multimeters

- Measures continuity, resistance and voltage.
- Data Hold feature saves measurement for later viewing.
- Audible continuity indicator.
- Lead storage.

Additional features for MM500:

- User-friendly three button design.
- IP67 dust and water proof.
- 10 foot / 3 meter drop protection.
- CAT IV safety rating for 600V.



CAT IV

NEW!

Measurement		MM100 Manual Ranging Multimeter	MM200 Auto Ranging Multimeter	MM500 Auto Ranging Multimeter
AC Current		—	10A	—
DC Current		10A	10A	—
AC Voltage		600V	600V	750V
DC Voltage		600V	600V	750V
Audible Continuity		●	●	●
Resistance Range		2MΩ	40MΩ	4000Ω
Battery Test		●	—	—
Data Hold		●	●	—
Diode Test		●	●	—
Protective Boot		●	●	—
Lead Storage		●	●	●
Auto Power Off		—	●	●
Back Light		—	●	●
Auto Ranging		—	●	●
Temperature		—	-4~1832°F	—
uA Setting		—	●	—
Capacitance		—	200μF	—
Range Hold		—	●	—
Frequency		—	1MHz	—
Max/Min		—	—	—
Duty Cycle		—	—	—
Relative Reading		—	—	—
Optional Hanger Kit		—	—	—
Bar Graph		—	—	—
Lead Warning		—	—	—
Auto Hold		—	—	●
True RMS		—	—	—
Low Impedance		—	—	—
Ingress Protection		—	—	IP67
Drop Protection		1m (3 ft)	1m (3 ft)	3m (10 ft)
Safety Rating		CAT III 600V	CAT III 600V	CAT IV 600V
Basic DC Accuracy		±0.5%	±0.5%	±0.5%
Counts		2000	4000	4000
Listings				
		3194551	3194551	452K



Multimeters

Professional Series Multimeters Continued

*A NIST certified product is guaranteed to have been specially tested to ensure its accuracy. NIST certified meters are special order (lead time: 7 business days). NIST certifications are good for one year from the date of calibration.



Measurement		MM1000/ MM1000N* Electrician's / HVAC Multimeter	MM1300/ MM1300N* Electrician's / HVAC Multimeter	MM2000/ MM2000N* Electrician's / HVAC TRMS Multimeter	MM2300/ MM2300N* Electrician's / HVAC TRMS Multimeter
AC Current	\tilde{A}	10A	10A	10A	10A
DC Current	\bar{A}	10A	10A	10A	10A
AC Voltage	\tilde{V}	1000V	1000V	1000V	1000V
DC Voltage	\bar{V}	1000V	1000V	1000V	1000V
Audible Continuity	o)	●	●	●	●
Resistance Range	Ω	40M Ω	60M Ω	40M Ω	60M Ω
Data Hold	HOLD	●	●	●	●
Diode Test	$\rightarrow $	●	●	●	●
Protective Boot		●	●	●	●
Lead Storage		●	●	●	●
Auto Power Off	Apo	●	●	●	●
Back Light		●	●	●	●
Auto Ranging	AUTO	●	●	●	●
Temperature	$^{\circ}F$ $^{\circ}C$	-58-1832 $^{\circ}F$ -50-1000 $^{\circ}C$	-58-1832 $^{\circ}F$ -50-1000 $^{\circ}C$	-58-1832 $^{\circ}F$ -50-1000 $^{\circ}C$	-58-1832 $^{\circ}F$ -50-1000 $^{\circ}C$
uA Setting	$\tilde{\mu}A$	●	●	●	●
Capacitance	H	4000 μF	6000 μF	4000 μF	6000 μF
Range Hold	RANGE	●	●	●	●
Frequency	Hz	499.9kHz	499.9kHz	499.9kHz	499.9kHz
Max/Min	MAX/MIN	●	●	●	●
Duty Cycle	%	●	●	●	●
Relative Reading	Δ	●	●	●	●
Optional Hanger Kit		●	●	●	●
Bar Graph		●	●	●	●
Lead Warning		—	●	—	●
Auto Hold	A-HOLD	—	●	—	●
True RMS	TRMS	—	—	●	●
Low Impedance	LOW Z	—	—	●	●
Ingress Protection		IP20	IP20	IP20	IP20
Drop Protection		2m (6 ft)	2m (6 ft)	2m (6 ft)	2m (6 ft)
Safety Rating		CAT IV 600V	CAT IV 600V	CAT IV 600V	CAT IV 600V
Basic DC Accuracy		$\pm 0.5\%$	$\pm 0.5\%$	$\pm 0.5\%$	$\pm 0.5\%$
Counts		4000	6000	4000	6000
Listings					

All dimensions are in inches and (millimeters).



Multimeters

Multimeter Specifications

Cat. No.	NIST certified	CAT Rating	Batteries	Height	Width	Depth	Weight	Included Accessories
MM100	—	CAT III 600V	1 x 9V	5.75" (146 mm)	2.75" (70 mm)	1.75" (45 mm)	8.0 oz. (227 g)	test leads
MM200	—	CAT III 600V	1 x 9V	5.75" (146 mm)	2.75" (70 mm)	1.75" (45 mm)	8.2 oz. (232 g)	test leads thermocouple
MM500	—	CAT IV 600V	2 x AAA	5.75" (146 mm)	2.75" (70 mm)	1.75" (45 mm)	8.0 oz. (227 g)	test leads NEW!
MM1000	—	CAT IV 600V	2 x AAA	7.00" (178 mm)	3.50" (89 mm)	1.875" (48 mm)	14.0 oz. (397 g)	test leads, thermocouple
MM1000N	yes	CAT IV 600V	2 x AAA	7.00" (178 mm)	3.50" (89 mm)	1.875" (48 mm)	14.0 oz. (397 g)	test leads, thermocouple
MM1300	—	CAT IV 600V	2 x AAA	7.00" (178 mm)	3.50" (89 mm)	1.875" (48 mm)	14.0 oz. (397 g)	test leads, thermocouple, case
MM1300N	yes	CAT IV 600V	2 x AAA	7.00" (178 mm)	3.50" (89 mm)	1.875" (48 mm)	14.0 oz. (397 g)	test leads, thermocouple, case
MM2000	—	CAT IV 600V	2 x AAA	7.00" (178 mm)	3.50" (89 mm)	1.875" (48 mm)	14.0 oz. (397 g)	test leads, thermocouple
MM2000N	yes	CAT IV 600V	2 x AAA	7.00" (178 mm)	3.50" (89 mm)	1.875" (48 mm)	14.0 oz. (397 g)	test leads, thermocouple
MM2300	—	CAT IV 600V	2 x AAA	7.00" (178 mm)	3.50" (89 mm)	1.875" (48 mm)	14.0 oz. (397 g)	test leads, thermocouple, case
MM2300N	yes	CAT IV 600V	2 x AAA	7.00" (178 mm)	3.50" (89 mm)	1.875" (48 mm)	14.0 oz. (397 g)	test leads, thermocouple, case
MM5000	—	CAT IV 600V	2 x AAA	7.00" (178 mm)	3.50" (89 mm)	1.875" (48 mm)	14.0 oz. (397 g)	test leads, case
MM5000N	yes	CAT IV 600V	2 x AAA	7.00" (178 mm)	3.50" (89 mm)	1.875" (48 mm)	14.0 oz. (397 g)	test leads, case
MM6000	—	CAT IV 600V	2 x AAA	7.00" (178 mm)	3.50" (89 mm)	1.875" (48 mm)	14.0 oz. (397 g)	test leads, thermocouple, case
MM6000N	yes	CAT IV 600V	2 x AAA	7.00" (178 mm)	3.50" (89 mm)	1.875" (48 mm)	14.0 oz. (397 g)	test leads, thermocouple, case

Multimeter Replacement Fuses



69192

Cat. No.	For Use With	Fuse Type
69191	MM1000, MM1300, MM2000, MM2300, MM6000	F 11A / 1000V
69192	MM1000, MM1300, MM2000, MM2300, MM6000	F 440mA / 1000V
69193	MM100 Fuse Kit	F10A / 500V, F250mA / 250V
69194	MM200 Fuse Kit	F10A / 500V, F400mA / 250V

▲WARNINGS:

To ensure safe operation and service of the tester, follow these instructions. Failure to observe these warnings can result in severe injury or death.

- Before each use, verify meter operation by measuring a known voltage or current.
- Never use the meter on a circuit with voltages that exceed the category based rating of this meter.
- Do not use the meter during electrical storms, or in wet weather.
- Do not use the meter or test leads if they appear to be damaged.
- Ensure meter leads are fully seated, and keep fingers away from the metal probe contacts when making measurements.
- Do not open the meter to replace batteries while the probes are connected.
- Use caution when working with voltages above 60V DC, or 25V AC RMS. Such voltages pose a shock hazard.
- To avoid false readings that can lead to electrical shock, replace batteries if a low battery indicator appears.
- Unless measuring voltage or current, shut off and lock out power before measuring resistance or capacitance.
- Always adhere to local and national safety codes. Use individual protective equipment to prevent shock and arc blast injury where hazardous live conductors are exposed.

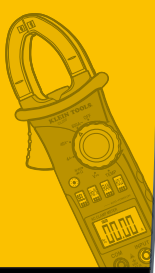

Clamp Meters

Professional Series Clamp Meters

- Large jaw sizes.
- Worklights illuminate dark work spaces.
- Data hold captures measurements in any situation.

Additional Features for Cat. Nos. CL1000, CL1200, CL1300

- Built-in magnetic mount for hands-free convenience.
- Non-contact voltage detection at the push of a button.
- Quick-response bar graph shows elusive fluctuations.



Measurement		CL100 600A AC Clamp Meter	CL200 600A AC Clamp Meter w/ Temp	CL1000/CL1000N* 400A AC Clamp Meter	CL1200/CL1200N* 600A AC Clamp Meter	CL1300/CL1300N* 600A AC Clamp Meter w/ Temp
AC Current		600A	600A	400A	600A	600A
DC Current		—	—	—	—	—
AC Voltage		600V	600V	750V	750V	750V
DC Voltage		600V	600V	1000V	1000V	1000V
Audible Continuity		•	•	•	•	•
Resistance Range		20MΩ	40MΩ	40MΩ	60MΩ	60MΩ
Data Hold		•	•	•	•	•
Auto Power Off		•	•	•	•	•
Diode Test		•	•	•	•	•
Back Light		•	•	•	•	•
Work/Clamp Light		•	•	•	•	•
Frequency		—	100kHz	499.9kHz	499.9kHz	499.9kHz
Capacitance		—	100μF	4000μF	6000μF	6000μF
Duty Cycle		—	•	•	•	•
Temperature		—	-4-1832°F -20-1000°C	—	—	-22-752°F -30-1000°C
Non-Contact Voltage Test		—	—	•	•	•
Max/Min		Max	—	•	•	•
μA Setting		—	•	•	•	•
Rel/Zero		—	—	—	•	•
Magnetic Mount		—	—	•	•	•
Bar Graph		—	—	•	•	•
True RMS		—	—	—	—	—
Low Impedance		—	—	—	—	—
Ingress Protection		—	—	—	IP42	IP42
Drop Protection		1m (3 ft)	1m (3 ft)	1m (3 ft)	2m (6 ft)	2m (6 ft)
Safety Rating		CAT III 600V	CAT III 600V	CAT III 600V	CAT IV 600V	CAT IV 600V
Counts		2000	4000	4000	6000	6000
Listings						

All dimensions are in inches and (millimeters).



Clamp Meters

Professional Series Clamp Meters Cont.

**Additional Features for
Cat. Nos. CL2000, CL2200, CL2300, CL2500**

- Built-in magnetic mount for hands-free convenience.
- Non-contact voltage detection at the push of a button.
- Quick-response bar graph shows elusive fluctuations.

**A NIST certified product is guaranteed to have been specially tested to ensure its accuracy. NIST certified meters are special order (lead time: 7 business days). NIST certifications are good for one year from the date of calibration.*



Measurement		CL2000/CL2000* 400A AC/DC TRMS Clamp Meter	CL2200/ CL2200* 600A AC/DC TRMS Clamp Meter	CL2300/ CL2300* 600A AC/DC TRMS Clamp Meter w/ Temp	CL2500/ CL2500* 1000A AC/DC TRMS Clamp Meter
AC Current		400A	600A	600A	1000A
DC Current		400A	600A	600A	1000A
AC Voltage		750V	750V	750V	750V
DC Voltage		1000V	1000V	1000V	1000V
Audible Continuity		•	•	•	•
Resistance Range		40MΩ	60MΩ	60MΩ	60MΩ
Data Hold	HOLD	•	•	•	•
Auto Power Off	Apo	•	•	•	•
Diode Test		•	•	•	•
Back Light		•	•	•	•
Work/Clamp Light		•	•	•	•
Frequency	Hz	499.9kHz	499.9kHz	499.9kHz	499.9kHz
Capacitance		4000μF	6000μF	6000μF	6000μF
Duty Cycle	%	•	•	•	•
Temperature	°F °C	—	—	-22-752°F -30-400°C	—
Non-Contact Voltage Test	NCV	•	•	•	•
Max/Min	MAX/MIN	•	•	•	•
μA Setting		•	•	•	•
Rel/Zero		•	•	•	•
Magnetic Mount		•	•	•	•
Bar Graph		•	•	•	•
True RMS	TRMS	•	•	•	•
Low Impedance	LOW Z	—	—	—	—
Ingress Protection		—	IP42	IP42	IP42
Drop Protection		1m (3 ft)	2m (6 ft)	2m (6 ft)	1m (3 ft)
Safety Rating		CAT III 600V	CAT IV 600V	CAT IV 600V	CAT IV 600V
Counts		4000	6000	6000	6000
Listings		UL US LISTED 45ZK	UL US LISTED 45ZK	UL US LISTED 45ZK	UL US LISTED 45ZK

All dimensions are in inches and (millimeters).



Clamp Meters

Clamp Meter Specifications

Cat. No.	CAT Rating	Batteries	Jaw Size	Height	Width	Depth	Weight	Included Accessories
CL100	CAT III 600V	3 x AAA	1.0" (25 mm)	8.2" (208 mm)	3.0" (76 mm)	1.4" (36 mm)	9.9 oz. (281 g)	test leads, case
CL200	CAT III 600V	3 x AAA	1.0" (25 mm)	8.2" (208 mm)	3.0" (76 mm)	1.4" (36 mm)	10.0 oz. (283 g)	test leads, case, thermocouple
CL1000	CAT III 600V	2 x AAA	1.25" (32 mm)	8.875" (225 mm)	3.375" (86 mm)	1.5" (38 mm)	10.7 oz. (303 g)	test leads, case
CL1200	CAT III 600V	2 x AAA	1.25" (32 mm)	7.65" (194 mm)	2.56" (65 mm)	1.38" (35 mm)	11.9 oz. (337 g)	test leads, case
CL1300	CAT III 600V	2 x AAA	1.25" (32 mm)	7.65" (194 mm)	2.56" (65 mm)	1.38" (35 mm)	11.9 oz. (337 g)	test leads, case, thermocouple
CL2000	CAT III 600V	2 x AAA	1.25" (32 mm)	8.875" (225 mm)	3.375" (86 mm)	1.5" (38 mm)	10.7 oz. (303 g)	test leads, case
CL2200	CAT III 600V	2 x AAA	1.25" (32 mm)	7.65" (194 mm)	2.56" (65 mm)	1.38" (35 mm)	11.9 oz. (337 g)	test leads, case
CL2300	CAT III 600V	2 x AAA	1.25" (32 mm)	7.65" (194 mm)	2.56" (65 mm)	1.38" (35 mm)	11.9 oz. (337 g)	test leads, case, thermocouple
CL2500	CAT IV 600V	2 x AAA	1.97" (50 mm)	8.09" (205 mm)	2.56" (65 mm)	1.38" (35 mm)	13.6 oz. (386 g)	test leads, case



⚠WARNINGS:

To ensure safe operation and service of the tester, follow these instructions. Failure to observe these warnings can result in severe injury or death.

- Before each use, verify meter operation by measuring a known voltage or current.
- Never use the meter on a circuit with voltages that exceed the category based rating of this meter.
- Do not use the meter during electrical storms, or in wet weather.
- Do not use the meter or test leads if they appear to be damaged.
- Ensure meter leads are fully seated, and keep fingers away from the metal probe contacts when making measurements.
- Do not open the meter to replace batteries while the probes are connected.
- Use caution when working with voltages above 60V DC, or 25V AC RMS. Such voltages pose a shock hazard.
- To avoid false readings that can lead to electrical shock, replace batteries if a low battery indicator appears.
- Unless measuring voltage or current, shut off and lock out power before measuring resistance or capacitance.
- Always adhere to local and national safety codes. Use individual protective equipment to prevent shock and arc blast injury where hazardous live conductors are exposed.

Specialty Clamp Meters

200A AC Fork Meter

- Open jaw conveniently measures 1/0 wire and AC currents up to 200A. Cat. No. CL3200 measures 3/0 wire.
- Backlit display is readable even in dark locations.
- Relative reading feature automatically calculates the difference between the live measurement and a previously stored measurement.



**A NIST certified product is guaranteed to have been specially tested to ensure its accuracy. NIST certified meters are special order (lead time: 7 business days). NIST certifications are good for one year from the date of calibration.*



200A AC Hook Meter

- Unique hook-style current clamp fits into tight spaces and measures 1/0 wire.
- Automatically selects voltage or current based on what is being measured. No manual switching between current and voltage required.
- Bright white LED worklight illuminates any workspace.



Measurement		CL3000	CL3100	CL3200/ CL3200N*
		200A AC Fork Meter	200A AC Hook Meter	200A AC Fork Meter
AC Current	\tilde{A}	200A	200A	200A
AC Voltage	\tilde{V}	750V	750V	750V
DC Voltage	\bar{V}	1000V	1000V	1000V
Resistance	Ω	40M Ω	40M Ω	40M Ω
Capacitance	μF	40 μF	—	—
Frequency / Duty Cycle	Hz%	100kHz	—	—
Diode Test	$\rightarrow $	●	—	—
Continuity	\equiv	●	●	●
Accepts Wire		1/0	1/0	3/0
Non Contact Voltage	NCV	—	—	●
Data Hold	HOLD	●	—	●
Relative Reading	Δ	●	—	—
Auto Power-Off	Apo	●	●	●
Auto Range	RANGE	●	●	●
Backlight	\odot	●	●	●
Worklight	\rightarrow	—	●	●
Voltage / Current Auto Select	Auto	—	●	●
Max/Min	MAX/MIN	—	●	—
Bar Graph	\equiv	—	●	●
Magnetic Hanger	\hookrightarrow	—	●	●
Low Impedance	LOW Z	—	—	●
Ingress Protection	\equiv	—	—	IP30
Drop Protection	\downarrow	1m (3 ft)	1m (3 ft)	2m (6 ft)
Safety Rating	\triangle	CAT III 600V	CAT IV 600V	CAT IV 600V
Display Counts	00.00	4000	4000	4000
Listings		ETL LISTED	CE	UL LISTED 45ZK

Cat. No.	NIST certified	CAT Rating	Batteries	Jaw Size	Height	Width	Depth	Weight	Included Accessories
CL3000	—	CAT III 600V	1 x 9V	0.5" (13 mm)	7.50" (191 mm)	2.70" (69 mm)	1.70" (43 mm)	7.4 oz. (210 g)	test leads, case
CL3100	—	CAT IV 600V	2 x AAA	0.5" (13 mm)	10.25" (260 mm)	2.50" (64 mm)	1.50" (38 mm)	8.6 oz. (244 g)	test leads, case
CL3200	—	CAT IV 600V	2 x AAA	0.63" (16 mm)	7.06" (179 mm)	2.56" (65 mm)	1.34" (34 mm)	7.9 oz. (224 g)	test leads, case
CL3200N*	yes	CAT IV 600V	2 x AAA	0.63" (16 mm)	7.06" (179 mm)	2.56" (65 mm)	1.34" (34 mm)	7.9 oz. (224 g)	test leads, case

All dimensions are in inches and (millimeters).



Electrical Testers

Electronic Voltage Testers

- Measures AC and DC voltage at nine common levels up to 600V.
- Probe wires with wear indicators built in.
- Bright LEDs indicate voltage reading without batteries installed.
- Low impedance input reduces possibility of ghost voltages.
- Permanently secured test leads are always there when they are needed.
- Molded lead holders are perfect for easy measurements of tamper-proof outlets.
- Vibration and sound alerts for dangerous voltage levels.
- Modern solid-state construction provides CAT IV 600V safety rating.

Additional Features for Cat. No. ET200

- Bright worklight to illuminate your work space.
- Audible continuity.



ET200



Cat. No.	CAT Rating	Batteries	Height	Width	Depth	Weight
ET100	CAT IV 600V	3 x AAA	7.375" (187 mm)	2.375" (60.3 mm)	1.25" (31.8 mm)	8.1 oz. (230 g)
ET200	CAT IV 600V	3 x AAA	7.375" (187 mm)	2.375" (60.3 mm)	1.25" (31.8 mm)	8.1 oz. (230 g)

Digital Circuit Breaker Finder

- Quickly, accurately, and automatically find the correct circuit breaker of any standard 120V outlet.
- Does not require interruption of service. Power can be left on.
- Bright green arrow and loud beeping tone provide clear indication of correct breaker.
- Strong transmitter reaches distances up to 1000 feet.
- Find breakers of light fixtures and bare wires with optional adapter set (Cat. No. 69411, see accessories page).



ET300



Cat. No.	Batteries	Height	Width	Depth	Weight	
ET300	receiver	1 x 9V	6.00" (152 mm)	2.00" (50.8 mm)	0.90" (22.9 mm)	3.2 oz. (90.7 g)
	transmitter	N/A	2.80" (71.1 mm)	1.90" (48.3 mm)	1.20" (30.5 mm)	1.6 oz. (45.4 g)

All dimensions are in inches and (millimeters).



Electrical Testers

Non-Contact Voltage Testers (NCVT-1/NCVT-2)

CAT IV

- Non-contact detection of standard voltage in cables, cords, circuit breakers, lighting fixtures, switches, outlets, and wires.
- High intensity, bright green LED indicates the tester is operational and aids in illuminating the workspace.
- Digitally controlled ON/OFF power button.
- Auto power-off feature conserves and extends battery life.
- Microprocessor controlled low-battery indicator.
- CAT IV 1000 Volt rating provides expanded operation and protection.
- Lightweight, durable polycarbonate plastic resin construction with a convenient pocket-clip.
- Package contains insert card w/ integrated owner's manual and two AAA 1.5 volt batteries.



NCVT-1



Additional Features for Dual Range NCVT-2

- Automatically detects and indicates low voltage (12-48 Volts AC) and standard voltage (48-1000 Volts AC), allowing broad application.
- Non-contact detection of low-voltage in security, entertainment, communications, environmental control, and irrigation systems.

Voltage Range	12 TO 48 VOLTS AC (Low) (NCVT-2 only)	48 TO 1000 VOLTS AC (Standard)
Audible	low-pitched pulsing beeping sound	high-pitched continuous beeping sound
Visual	blue LED turns off and red LED blinks (approximately 2-times per second).	green LED turns off and red LED illuminates continuously.

CAT IV



NCVT-2



UL LISTED 3TMV

Cat. No.	Voltage Range	Frequency Range	Pollution Degree	Batteries	Overall Length	Width	Height	Weight (oz.)	Weight w/ Batteries (oz.)
NCVT-1	48-1000 volts AC	50-500 Hz	2	2 x AAA	5.50" (140 mm)	0.72" (18 mm)	1.0" (25 mm)	0.8 oz. (23 g)	1.6 (46 g)
NCVT-2	12-1000 volts AC	50-500 Hz	2	2 x AAA	5.50" (140 mm)	0.72" (18 mm)	1.0" (25 mm)	0.8 oz. (23 g)	1.6 (46 g)

▲WARNINGS:

- It is important that users of this tester read, understand, and follow all warnings, cautions, safety information, and instructions in the manual before operating or servicing this tester. Failure to follow instructions could result in death or serious injury.
- Risk of electric shock and burn. Contact with live circuits could result in death or serious injury.
- Use caution with voltages above 30V AC as a shock hazard may exist.
- A blinking or steady red glow and an audible beep indicate voltage present. If no indication, voltage could still be present.
- In bright light conditions, the LED visual indicators will be less visible.
- Do not use if green LED is not illuminated.

▲WARNINGS:

- Do not use if tester appears damaged or if the tester is not operating properly. If in doubt, replace the tester.
- Do not apply more than the rated voltage as marked on the tester (1000 volts AC).
- Always wear approved eye protection.
- Before each use, verify operation by testing a known working circuit that is within the rating of this tester.
- Do not rely on this tester with shielded wire. Operation may be affected by differences in socket design and insulation thickness and type.
- Comply with local and national safety requirements.
- If this tester is used in a manner not specified by the manufacturer, protection provided by the tester may be affected.

▲CAUTION: Do not attempt to repair this tester. It contains no serviceable parts. Do not expose the product to extremes in temperature or high humidity.



Specialty Testers

12:1 Infrared Thermometer

- Backlit display.
- Fahrenheit or Celsius.
- MAX, MIN, AVG, Differential calculations.
- 12:1 spot ratio allows quick checks of all types of environments, hazardous extreme temperature ranges, or remote areas.
- Temperature range of -58 to 1000°F (-50 to 538°C).

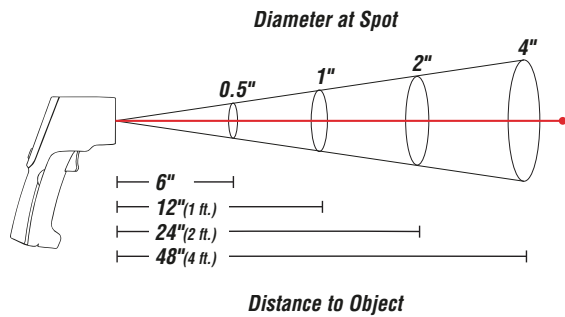

IR1000

Cat. No.	Batteries	Height	Width	Depth	Weight
IR1000	2 x AAA	7" (178 mm)	3.25" (82.6 mm)	1.74" (44.2 mm)	8.1 oz. (230 g)

12:1 Dual Laser Infrared Thermometer

- Backlit display.
- Dual laser targeting.
- Fahrenheit or Celsius button.
- K-Type thermocouple input.
- 12:1 spot ratio.
- -76° to 1022°F measurement range.
- Auto shut off.
- High/Low alarm.
- Auto-scan.
- Work light.

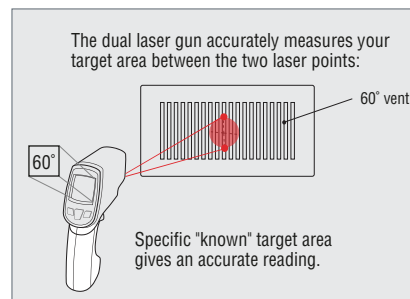
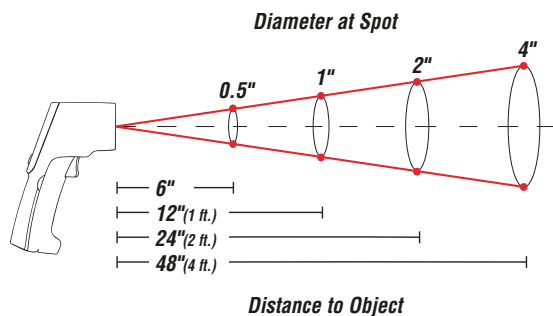

IR2000

*A NIST certified product is guaranteed to have been specially tested to ensure its accuracy. NIST certified meters are special order (lead time: 7 business days). NIST certifications are good for one year from the date of calibration.

Cat. No.	Batteries	Height	Width	Depth	Weight
IR2000	2 x AAA	6.76" (171.7 mm)	1.87" (47.5 mm)	4.7" (119.4 mm)	9.0 oz. (255.1 g)
IR2000N*	2 x AAA	6.76" (171.7 mm)	1.87" (47.5 mm)	4.7" (119.4 mm)	9.0 oz. (255.1 g)

All dimensions are in inches and (millimeters).



Specialty Testers

30:1 Dual Laser Infrared Thermometer

- Backlit display.
- Dual laser targeting.
- Fahrenheit or Celsius button.
- K-Type thermocouple input.
- 30:1 spot ratio.
- -76° to 1400°F measurement range.
- Auto shut off.
- High/Low alarm.
- Auto-scan.
- Work light.

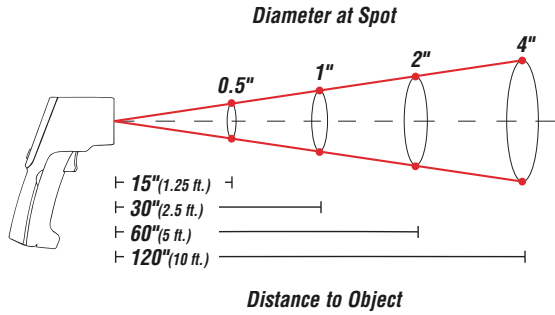

**A NIST certified product is guaranteed to have been specially tested to ensure its accuracy. NIST certified meters are special order (lead time: 7 business days). NIST certifications are good for one year from the date of calibration.*

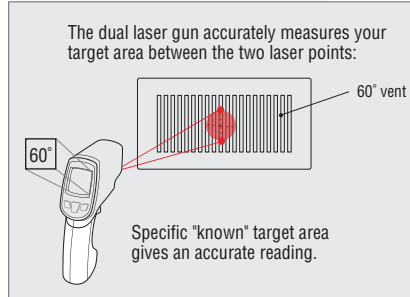

IR3000

Cat. No.	Batteries	Height	Width	Depth	Weight
IR3000	2 x AAA	6.76" (171.7 mm)	1.87" (47.5 mm)	4.7" (119.4 mm)	9.0 oz. (255 g)
IR3000N*	2 x AAA	6.76" (171.7 mm)	1.87" (47.5 mm)	4.7" (119.4 mm)	9.0 oz. (255 g)

Digital Temperature Loggers

Dual Input Temperature Logger

- IP67: Dust and waterproof.
- Differential temperature.
- Data logging.
- 9,999 memory positions.
- MIN, MAX, AVG & Hold.
- USB interface.
- Thermocouple temperature offset.
- Backlit display.
- Probe storage.

Thermocouple	Temperature Range °F	Temperature Range °C
J-Type	-346° to 2192°F	-210° to 1200°C
K-Type	-328° to 2498°F	-200° to 1370°C
T-Type	-328° to 752°F	-200° to 400°C
E-Type	-238° to 1832°F	-150° to 1000°C



DTL302



DTL304

Cat. No.	Inputs	Batteries	Height	Width	Depth	Weight	Included Accessories
DTL302	2	2 x AAA	7.20" (183 mm)	3.70" (94 mm)	1.70" (43 mm)	16.2 oz. (459 g)	magnetic hanger, thermocouples, usb power adapter & cable, software, batteries
DTL304	4	2 x AAA	7.20" (183 mm)	3.70" (94 mm)	1.70" (43 mm)	16.2 oz. (459 g)	magnetic hanger, thermocouples, usb power adapter & cable, software, batteries

All dimensions are in inches and (millimeters).



Specialty Testers

Video Borescope

- Video/audio & photo recording.
- Bright LED worklight.
- IP67: Dust and waterproof camera.
- Screen rotation.
- TV-out & SD card.
- File playback.



Multiple Applications!

- Electrical
 - HVAC
 - Plumbing
 - Automotive
 - Aircraft
- Use to view inaccessible areas:
 - Inside a wall
 - Down the drain
 - In furnace or vent

Package contents:

Main unit, gooseneck camera 17 mm, 18650 series 3.7v 2000mAh rechargeable Li-ion battery, mirror camera attachment, hook camera attachment, magnet camera attachment, USB power adapter/charger, USB data/charger cable, RCA composite A/V to 3.5 mm mini A/V cable, quick start guide, software/instruction manual CD-ROM, carrying case

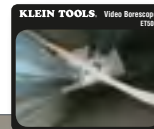

ET500



Cat. No.	Batteries	Height	Width	Depth	Weight
ET500	2 x AAA	7" (178 mm)	3.25" (82.6 mm)	1.74" (44.2 mm)	8.1 oz. (230 g)

Borescope

- 2.4" color LCD.
- Bright LED work light.
- IP67: Dust and waterproof camera.
- Screen mirror.
- Auto power off.



ET510

Multiple Applications!

- Electrical
 - HVAC
 - Plumbing
 - Automotive
 - Aircraft
- Use to view inaccessible areas:
 - Inside a wall
 - Down the drain
 - In furnace or vent

Package contents:

Main unit, gooseneck camera 17 mm, mirror camera attachment, hook camera attachment, magnet camera attachment, USB power adapter/charger, USB data/charger cable.

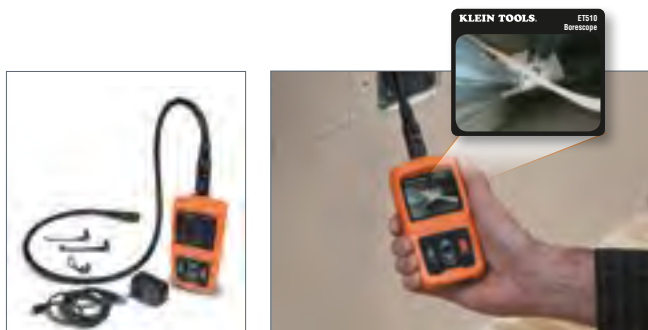

Cat. No.	Batteries	Height	Width	Depth	Weight
ET510	lithium ion	6.53" (165.9 mm)	2.84" (72.2 mm)	1.55" (39.4 mm)	8.08 oz. (229 g)

All dimensions are in inches and (millimeters).



Electrical Testers

Receptacle Testers



Made in USA of US and imported parts.



RT500 RT600

- Designed to detect the most common wiring problems in standard receptacles.
- Conditions indicated: wiring correct, open ground, reverse polarity, open hot, open neutral, hot/ground reversed.
- Conditions NOT indicated: quality of ground, multiple hot wires, combinations of defects, reversal of grounded and grounding conductors.

Cat. No.	GFCI	Dimensions	Weight
RT500	no	1.74" x 2.8" x 1.15" (44.2 mm x 71.1 mm x 29.2 mm)	1.95 oz. (55.3 g)
RT600	yes	1.74" x 2.8" x 1.15" (44.2 mm x 71.1 mm x 29.2 mm)	1.97 oz. (55.9 g)

Continuity Tester

- Quickly reveals shorts or broken circuits in all types of electrical devices and controls.
- Tests for continuity of circuit with power off.
- Bulb in handle glows when circuit is complete (bulb included).
- Pointed 3-3/4" (95 mm) probe gets right to the problem.
- Deluxe 4" (102 mm) long handle with removable nylon cap holds replaceable bulb and battery.
- 36" (915 mm) test lead with alligator clip.
- Uses one AAA battery (not included).



69133



Made in USA of US and imported parts.

Cat. No.	Overall Length	Weight (lbs.)
69133	probe to clip, 43-3/4" (1099 mm)	0.20 oz. (5.7 g)
Replacement Part		
69131	replacement bulb for Cat. No. 69133	0.04 oz. (1.2 g)

Receptacle Testers



RT100 RT200

- Designed to detect the most common wiring problems in standard receptacles.
- Conditions indicated: wiring correct, open ground, reverse polarity, open hot, open neutral, hot/ground reversed.
- Conditions NOT indicated: quality of ground, multiple hot wires, combinations of defects, reversal of grounded and grounding conductors.

Cat. No.	GFCI	Dimensions	Weight
RT100	no	1.5" x 2.75" x 1" (38.1 mm x 69.9 mm x 25.4 mm)	1.27 oz. (36 g)
RT200	yes	1.5" x 2.75" x 1" (38.1 mm x 69.9 mm x 25.4 mm)	1.38 oz. (39.1 g)

Low-Voltage Tester

- Device for checking live 6-24V, AC or DC circuits.
- Tests for shorts in automotive and truck electrical systems, motor field coils, radio and low-voltage circuits, ground circuits of all lamps, wiring, fuses, etc.
- Bulb in handle glows when circuit is complete (bulb included).
- Pointed 3-3/4" (95 mm) probe makes checking easier.
- Deluxe 3-1/2" (89 mm) long handle with nylon top holds replaceable bulb.
- 36" (915 mm) test lead with alligator clip.



69127



Made in USA of US and imported parts.

Cat. No.	Overall Length	Weight (lbs.)
69127	probe to clip, 43-1/4" (1099 mm)	0.20 oz. (5.7 g)
Replacement Part		
69130	replacement bulb for Cat. No. 69127	0.01 oz. (.3 g)

Circuit Tester

- Tests circuits rated from 80 to 600 volts AC/DC.
- High-visibility neon lamp indicator.
- High-impact, sealed 5-11/16" (144 mm) probe on long 24" (610 mm) leads for convenience in testing motors, fuses, relays, switches, etc.
- Resistor between each probe and lead.
- Reliable electronic components.



69105

Cat. No.	Overall Length with Probes	Weight
69105	35" (889 mm)	2.4 oz. (68.1 g)

All dimensions are in inches and (millimeters).

⚠WARNING: Do NOT use continuity tester for checking continuity on live circuits.



Electrical Testers

Multi-Volt Twin-Lead Tester



69135

- Tests for DC polarity, frequency, and polyphase line.
- Checks and indicates voltage on circuits up to 460 volts, AC or DC.
- Combination of glow lamps indicate voltage being tested—110, 220, 277, or 460 volts.
- Test leads furnished with probes on the ends.

Cat. No.	Overall Length	Weight
69135	7-7/8" (200 mm)	0.08 oz. (2.3 g)

Low-Voltage Twin-Lead Tester

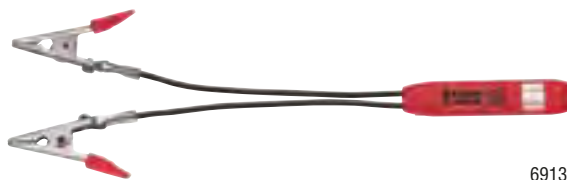

69134

- Tests 5-50 volt, AC or DC circuits and components.
- Built-in lamp glows if circuit is live.
- Each of the 4-1/2" (114 mm) test leads has an alligator clip on the end.
- Handy pocket clip.

Cat. No.	Overall Length	Weight
69134	8" (203 mm)	0.08 oz. (2.3 g)

Test Lead Set



69128

- Red and black.
- Set of two 32" (813 mm) leads.
- Each lead has alligator clips attached to both ends.

Cat. No.	Overall Length	Weight
69128	32" (813 mm)	6.4 oz. (181.4 g)

Circuit Breaker Finder Accessory Kit



69411

- For use with ET300 Digital Circuit Breaker Finder.
- Light socket adapter for finding the correct circuit of a lighting fixture.
- Alligator clip adapter enables use of Digital Circuit Breaker Finder on bare wires.

Cat. No.	Description	Weight
69411	ET300 digital circuit breaker finder accessory kit	2.1 oz. (59.5 g)

Replacement Test Lead Sets

- Standard banana-type inputs compatible with most multimeters and clamp meters.
- Leads compatible with and fit lead storage compartments on most Klein meters.
- Leads also compatible with Klein MM100, MM200, CL100 and CL200 meters but not sized for lead storage compartments.
- Includes one pair each of universal test leads and alligator clips.
- Safety rating: CAT III 1000V / CAT IV 600V.



69410

69416

Additional Features for Premium Silicone Test Lead Set

- Silicone insulated for greater performance in temperature extremes.
- Enhanced strain relief and durability.

Cat. No.	Description	Overall Length	Weight
69410	universal test lead set	42" (1,067 mm)	3.2 oz. (90.7 g)
69416	universal premium silicone test lead set	48" (1,219 mm)	3.4 oz. (96.3 g)

All dimensions are in inches and (millimeters).



Test & Measurement Line Accessories

Replacement K-Type Thermocouples



69412



69413



69414

Cat. No.	Description	Multimeter	Clamp Meter	IR Gun	DTL	Weight
69412	K-type banana thermocouple	MM100, MM1000, MM1300, MM2000, MM2300, MM6000	CL1200, CL1300, CL2300	—	—	0.7 oz. (19.8 g)
69413	K-type thermocouple	—	—	IR2000, IR3000	—	0.2 oz. (5.7 g)
69414	DTL K-type thermocouple	—	—	—	DTL302, DTL304	0.2 oz. (5.7 g)

6 mm Borescope Camera

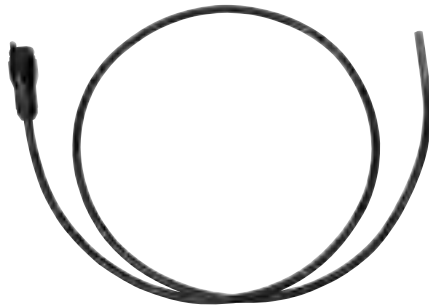

69450

- Bright LED worklight.
- IP67 gooseneck design for greater control and positioning.
- Smaller footprint when penetrating walls and panels.

Cat. No.	Dimensions	Weight
69450	6 mm x 1 m (0.24" x 3.3')	3.5 oz. (99.2 g)
69451	6 mm x 2 m (0.24" x 6.6')	5.5 oz. (155.9 g)

17 mm Borescope Camera



69454

- Bright LED worklight.
- IP67 gooseneck design for greater control and positioning.

Cat. No.	Dimensions	Weight
69454	17 mm x 1 m (0.67" x 3.3')	9.5 oz. (269.3 g)

1 Meter Borescope Camera Extension



69455

- Extends the reach of 17 mm borescope cameras.
- Up to two extensions may be used with 17 mm camera without loss of video quality (3 m / 9.9 ft.).
- Maximum of four extensions plus camera.
- Compatible with smaller diameter cameras.

Cat. No.	Dimensions	Weight
69455	17 mm x 1 m (0.67" x 3.3')	9.3 oz. (263.7 g)

Borescope Attachment Tools



69457

- Compatible with 17 mm diameter camera.

Cat. No.	Set Contains	Weight
69457		0.4 oz. (11.3 g)
Description		Overall Length
	mirror camera attachment	1.625" (44.3 mm)
	hook camera attachment	3.00" (76.2 mm)
	magnet camera attachment	3.25" (82.6 mm)

All dimensions are in inches and (millimeters).



Test & Measurement Line Accessories

Line Splitter

- Assists in measuring the current draw of a connected load up to 15A without splitting the load's power cord.
- Voltmeter input jacks.
- Provides X10 mode and X1 mode.
- Designed for use with Klein Tools Test & Measurement Line (CL100, CL200, CL1000, CL1200, CL1300, CL2000, CL2200, CL2300, CL2500, CL3200).
- Works with many other manufacturers' clamp meters.

⚠WARNINGS:

- Do NOT use with loads greater than 15A.
- Risk of electric shock and burn. Contact with live circuits could result in death or serious injury.
- Do not use if line splitter appears damaged. If in doubt, replace line splitter. Do NOT use line splitter if wet. For indoors use only.

Cat. No.	Overall Length	Width	Weight
69400	6.2" (157 mm)	2.2" (558 mm)	3.9 oz. (110.6 g) w/ batteries



69400

Magnetic Hanger

- For use with multimeters MM1000, MM1300, MM2000, MM2300, MM5000 and MM6000.
- Clips securely into back of rubber boot.
- Strong magnet attaches securely to metal surfaces for hands-free use.

Cat. No.	Description	Weight
69190	magnetic hanger for electrician's multimeters	1.1 oz. (31.2 g)



69190



Test & Measurement Line Accessories

Tradesman Pro™ Carrying Cases

NEW!



69406

69407

69408



Made in USA of US and imported parts.

- Two layers of padding protect even delicate instruments.
- Heavy-duty zipper and rugged PVC coated polyester for durability.
- One interior and one exterior pocket for quick access and organization.
- Sturdy handle with box stitching for secure transportation and convenient hanging.
- Constructed of 1680d ballistic weave.
- Cat. Nos. 69406 and 69407 recommended for meters, testers, infrared guns and small tools.
- Cat. No. 69408 is recommended for meters, testers, borescopes, infrared guns and tools.

Cat. No.	Pockets	Width	Height	Depth	Weight
69406	1	4.50" (114 mm)	9.25" (235 mm)	2.25" (57 mm)	0.38 lbs. (0.17 kg)
69407	2	6.00" (152 mm)	10.25" (260 mm)	2.25" (57 mm)	0.53 lbs. (0.24 kg)
69408	2	7.00" (178 mm)	10.25" (260 mm)	2.25" (57 mm)	0.66 lbs. (0.30 kg)

Carrying Case

- Constructed of 600 Denier nylon with a heavy-duty PVC zipper and zinc alloy zipper tag.
- Convenient storage for most Klein test and measurement products.



69401

Cat. No.	Overall Size	Weight
69401	3-1/2" (89 mm) W x 9-1/2" (235 mm) H x 2 (50 mm)" D	2.5 oz. (70.9 g)



Tool Sets

Some projects are more complex than others and require a variety of tools to be used. For this reason, Klein has tool sets to assist professionals with these demanding projects.

F O R P R O F E S S I O N A L S . . . S I N C E 1 8 5 7 ®



Tool Sets



Tool Sets

41-Piece Journeyman™ Tool Set

JOURNEYMAN



80141

Cat. No.	Set Contains	Weight (lbs.)
80141		29.8

Cat. No.	Description
BLK12	12-piece ball-end hex-key caddy set – inch
J203-6	Journeyman™ standard long-nose pliers
J203-8N	Journeyman™ heavy-duty long-nose pliers – side-cutting & stripping
J502-10	10" Journeyman™ pump pliers with 1-3/4" (44 mm) jaw capacity
D507-8	8" adjustable wrench – extra capacity
D507-12	12" adjustable wrench – extra capacity
600-1	1/4" keystone-tip cushion-grip screwdriver – 1-1/2" (40 mm) round-shank
600-4	1/4" keystone-tip cushion-grip screwdriver – 4" (102 mm) heavy-duty square-shank
601-3	3/16" cabinet-tip cushion-grip screwdriver – 3" (76 mm) round-shank
601-6	3/16" cabinet-tip cushion-grip screwdriver – 6" (152 mm) round-shank
602-6	5/16" keystone-tip cushion-grip screwdriver – 6" (152 mm) heavy-duty round-shank
603-1	No. 2 Phillips cushion-grip screwdriver – 1-1/2" (40 mm) round-shank
603-3	No. 1 Phillips cushion-grip screwdriver – 3" (76 mm) round-shank
603-4B	wire bending No. 2 Phillips cushion-grip screwdriver – 4" (102 mm) round-shank

Cat. No.	Description
605-6	1/4" cabinet-tip cushion-grip screwdriver – 6" (152 mm) heavy-duty round-shank
631	7-piece cushion-grip nut driver set (3/16", 1/4", 5/16", 11/32", 3/8", 7/16", 1/2")
650	cushion-grip scratch awl
662	No. 2 square-recess tip cushion-grip screwdriver – 4" (102 mm) round-shank
670-6	3/16" cabinet-tip cushion-grip screwdriver – Rapi-Drive®
93125	25' x 1" tape measure with magnetic tip
931-9RE	torpedo level - magnetic
J1005	Journeyman™ crimping/cutting tool – non-insulated and insulated connectors
K1412	Klein-Kurve® dual NM cable stripper/cutter
J2000-9NETP	Journeyman™ high-leverage side-cutting pliers – fish tape pulling
J2000-48	Journeyman™ high-leverage diagonal-cutting pliers – angled head
5003-18	18" 10-pocket canvas tool bag with leather bottom
5139	canvas zipper bag
11055	Klein-Kurve® wire stripper/cutter – 10-18 AWG solid & 12-20 AWG stranded
44133	Klein-Kurve® heavy-duty utility knife – quick change retractable blade
46037	cable-splicer's kit
56003	Steel Fish Tape - 125' L x 1/8" W
58889	padded adjustable shoulder strap
60053	standard protective eyewear
J63050	Journeyman™ high-leverage cable cutter
85191	conduit-fitting and reaming screwdriver

All dimensions are in inches and (millimeters) unless otherwise specified.

▲WARNING: The tool belt provided in this kit is NOT an occupational protective belt.

▲WARNING: NOT insulated. Do NOT use these tools on or near live electrical circuits.

▲WARNING: Do NOT use screwdrivers to pry or chisel.

▲WARNING: Always wear approved eye protection.

▲WARNING: Do NOT open the tape measure case. Spring motor is under tension, and opening may cause injury.



Tool Sets

28-Piece Electrician Tool Set



80028

Cat. No.	Set Contains	Weight (lbs.)
80028		17.2

Cat. No.	Description
D203-8	heavy-duty long-nose pliers – side-cutting
D213-9NETP	high-leverage side-cutting pliers – fish tape pulling
D248-8	high-leverage diagonal-cutting pliers – angled head
D502-10	10" pump pliers with 1-3/4" (44 mm) jaw capacity
506-10	10" adjustable wrench – standard capacity
600-4	1/4" keystone-tip cushion-grip screwdriver – 4" (102 mm) heavy-duty square-shank
601-6	3/16" cabinet-tip cushion-grip screwdriver – 6" (152 mm) round-shank
602-6	5/16" keystone-tip cushion-grip screwdriver – 6" (152 mm) heavy-duty round-shank
603-4B	wire bending No. 2 Phillips cushion-grip screwdriver – 4" (102 mm) round-shank
605-6	1/4" cabinet-tip screwdriver – 6" (152 mm) heavy-duty round-shank
631	7-piece cushion-grip nut driver set (3/16", 1/4", 5/16", 11/32", 3/8", 7/16", 1/2")
662	No. 2 square-recess tip cushion-grip screwdriver – 4" (102 mm) round-shank
670-6	3/16" cabinet-tip cushion-grip screwdriver – Rapi-Drive®

Cat. No.	Description
93025	25' x 1" tape measure
930-9	magnetic torpedo level
1005	crimping/cutting tool – non-insulated and insulated connectors
5102-16	16" canvas tool bag
5139	canvas zipper bag
11045	wire stripper/cutter – 10-18 AWG solid wire
44100	utility knife – retractable blade
60056	frameless protective eyewear
85191	conduit-fitting and reaming screwdriver

All dimensions are in inches and (millimeters) unless otherwise specified.

▲WARNING: The tool belt provided in this kit is NOT an occupational protective belt.

▲WARNING: NOT insulated. Do NOT use these tools on or near live electrical circuits.

▲WARNING: Do NOT use screwdrivers to pry or chisel.

▲WARNING: Always wear approved eye protection.

▲WARNING: Do NOT open the tape measure case. Spring motor is under tension, and opening may cause injury.

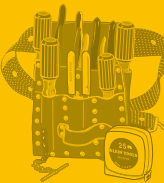

Tool Sets

18-Piece Journeyman™ Tool Set

JOURNEYMAN



80118

Cat. No.	Set Contains	Weight (lbs.)
80118		11.6

Cat. No.	Description
J203-8N	Journeyman™ heavy-duty long-nose pliers – side-cutting & stripping
J502-10	10" Journeyman™ pump pliers with 1-3/4" (44 mm) jaw capacity
D507-10	10" adjustable wrench – extra capacity
603-3	No. 1 Phillips cushion-grip screwdriver – 3" (76 mm) round-shank
603-4B	wire bending No. 2 Phillips cushion-grip screwdriver – 4" (102 mm) round-shank
605-4	1/4" cabinet-tip cushion-grip screwdriver – 4" (102 mm) heavy-duty round-shank
605-6	1/4" cabinet-tip cushion-grip screwdriver – 6" (152 mm) heavy-duty round-shank
630-1/4	1/4" cushion-grip nut driver – 3" (76 mm) shank
630-5/16	5/16" cushion-grip nut driver – 3" (76 mm) shank
662	No. 2 square-recess tip cushion-grip screwdriver – 4" (102 mm) round-shank

Cat. No.	Description
670-6	3/16" cabinet-tip cushion-grip screwdriver – Rapi-Drive®
93125	25' x 1" tape measure with magnetic tip
J2000-9NETP	Journeyman™ high-leverage side-cutting pliers – fish tape pulling
J2000-48	Journeyman™ high-leverage diagonal-cutting pliers - angled head
5165	10-pocket leather tool pouch
5705	Powerline™ web work belt
11055	Klein-Kurve® wire stripper/cutter – 10-18 AWG solid & 12-20 AWG stranded
60053	standard protective eyewear

All dimensions are in inches and (millimeters) unless otherwise specified.

▲WARNING: The tool belt provided in this kit is NOT an occupational protective belt.

▲WARNING: NOT insulated. Do NOT use these tools on or near live electrical circuits.

▲WARNING: Do NOT use screwdrivers to pry or chisel.

▲WARNING: Always wear approved eye protection.

▲WARNING: Do NOT open the tape measure case. Spring motor is under tension, and opening may cause injury.



Tool Sets

14-Piece Electrician Tool Set

Cat. No.	Set Contains	Weight (lbs.)
80014		9.6

Cat. No.	Description
D203-8	heavy-duty long-nose pliers – side-cutting
D213-9NETP	high-leverage side-cutting pliers – fish tape pulling
D248-8	high-leverage diagonal-cutting pliers – angled head
D502-10	10" pump pliers with 1-3/4" (44 mm) jaw capacity
603-3	No. 1 Phillips cushion-grip screwdriver – 3" (76 mm) round-shank
603-4B	wire bending No. 2 Phillips cushion-grip screwdriver – 4" (102 mm) round-shank
605-4	1/4" cabinet-tip cushion-grip screwdriver – 4" (102 mm) heavy-duty round-shank
605-6	1/4" cabinet-tip cushion-grip screwdriver – 6" (152 mm) heavy-duty round-shank
670-6	3/16" cabinet-tip cushion-grip screwdriver – Rapi-Drive®
93025	25' x 1" tape measure
5164	8-pocket leather tool pouch
5225	adjustable web tool belt
11045	wire stripper/cutter – 10-18 AWG solid wire
60056	frameless protective eyewear



80014

12-Piece Electrician Tool Set

Cat. No.	Set Contains	Weight (lbs.)
5300		6.82

Cat. No.	Description
5166	7-pocket leather tool pouch
5225	adjustable web belt
603-3	No. 1 Phillips cushion-grip screwdriver – 3" (76 mm) round-shank
603-4	No. 2 Phillips cushion-grip screwdriver – 4" (102 mm) round-shank
605-4	1/4" cabinet-tip cushion-grip screwdriver – 4" (102 mm) heavy-duty round-shank
605-6	1/4" cabinet-tip cushion-grip screwdriver – 6" (152 mm) heavy-duty round-shank
11045	wire stripper/cutter – 10-18 AWG solid wire
D248-8	high-leverage diagonal-cutting pliers – angled head
D203-8	heavy-duty long-nose pliers – side-cutting
D213-9NETP	high-leverage side-cutting pliers – fish tape pulling
D502-10	pump pliers with 1-3/4" (44 mm) jaw capacity
928-25HV	high-visibility power-return measuring tape



5300

All dimensions are in inches and (millimeters) unless otherwise specified.

▲WARNING: The tool belt provided in this kit is NOT an occupational protective belt.

▲WARNING: NOT insulated. Do NOT use these tools on or near live electrical circuits.

▲WARNING: Do NOT use screwdrivers to pry or chisel.

▲WARNING: Always wear approved eye protection.

▲WARNING: Do NOT open the tape measure case. Spring motor is under tension, and opening may cause injury.

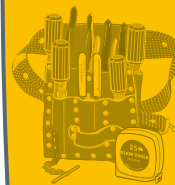

Tool Sets

12-Piece Electrician Tool Set



92003

Cat. No.	Set Contains	Weight (lbs.)
92003		17

Cat. No.	Description
D213-9NETP	9" high-leverage side-cutting pliers – fish tape pulling
D248-8	8" high-leverage diagonal-cutting pliers
D203-8	8" heavy duty long-nose pliers – side-cutting
D502-10	10" pump pliers
11045	wire stripper/cutter
93275	metric/english tape measure with magnetic tip
603-4	No. 2 profilated Phillips tip screwdriver – 4" round shank
605-4	1/4" cabinet tip cushion-grip screwdriver – 4" heavy duty round shank
661	No.1 square-recess tip screwdriver – 4" round shank
662	No. 2 square-recess tip cushion-grip screwdriver – 4" (102 mm) round-shank
5719	18 Pocket Tool Pouch
5705	Powerline™ web work belt

All dimensions are in inches and (millimeters) unless otherwise specified.

▲WARNING: The tool belt provided in this kit is NOT an occupational protective belt.

▲WARNING: NOT insulated. Do NOT use these tools on or near live electrical circuits.

▲WARNING: Do NOT use screwdrivers to pry or chisel.

▲WARNING: Always wear approved eye protection.

▲WARNING: Do NOT open the tape measure case. Spring motor is under tension, and opening may cause injury.



Alphabetical Index

Item	Page	Item	Page	Item	Page
10-in-1 Folding Screwdriver/Nut Driver	97	Cable Cutter, Armored	164	F	
10-in-1 Screwdriver/Nut Driver	97	Cable Cutters	63-68	F to BNC Adapter	44
11-in-1 Schrader® Valve Removal/Installation Bit	97	Cable Cutters, Insulated	74, 75	F to RCA Adapter	44
11-in-1 Screwdriver/Nut Driver	97	Canvas Tool Bags	205, 206	F-Splice Adapter 3 GHz	44
118° High-Speed Drill Bits	289	Carbide Hole Cutter	284	Fasteners, Sheet Metal	275
12-Piece Electrician Tool Set	331, 332	Carbide-Tipped Hole Cutter Kits	284	Fiberglass Tape Measure	153
14-Piece Electrician Tool Set	331	Carbide-Tipped, Masonry Drill Bits	289	Fish Tape Accessories	158-160
18-Piece Journeyman™ Tool Set	330	Chisels	307	Fish Tape Pulling Pliers	9, 192
2000 Series® Pliers .8, 12, 25-27, 64, 72, 73, 76, 77, 162		Clamp Meters	313-315	Fish Tapes	155, 156, 157
28-Piece Electrician Tool Set	329	Cleaners	171	Fish Tapes, Nylon	156
3-in-1 Impact Socket Wrench	136	Coaxial Tools	34, -37, 42, 46-47, 59, 64	Fish Tapes, Steel	157
4-in-1 Screwdriver	104	Combination Tool Apron	186	Flex-Bit Extensions	279
4-in-1 Tube Bender	273	Combination Tools	60	Flex-Bit Kit	280
4-Piece Carbide Hole Cutter Kit	284	Combination Wrenches	126-128	Flex-Bit Placement Tool	279
41-Piece Journeyman™ Tool Set	328	Compression Connectors, Universal	43	Flexible Drill Bits	279
5-in-1 Screwdriver/Nut Driver	97	Compression Connectors, Universal BNC	43	Folding Hex-Keys	144
8-Piece Master Electrician's Hole Cutter Kit	284	Compression Connectors, Universal F	43	Full Face Shield	169
90° F-Adapter 3 GHz	44	Compression Connectors, Universal RCA	43	G	
A		Conduit Bender Handles	164	Gloves	172-177
Adapter, 90° F	44	Conduit Benders	163	Gloves, Journeyman™	172-175
Adapter, F to BNC	44	Conduit Pliers	162	Grips, Copper/Steel Strand – Chicago®	244
Adapter, F to RCA	44	Conduit Scoring Tool	164	Grips, Interchangeable	247
Adapter, F-Splice	44	Conduit Tools	162-164	Grips, Steel Strand – Chicago®	243
Adjustable Hole Saw	283	Connecting Bars	257	Grips, Steel Strand – Haven's®	244
Adjustable Wrenches	124, 125	Construction Bars	260, 261	Grips, Wire Pulling Accessories	247
Aerial Aprons	220	Construction Tools	263, 264, 265	Grizzly® Bar	256
Anchors	289	Construction Wrenches	135-137, 258	Guards, Tool	190
Apron, Combination Tool	186	Copper/Steel Strand – Chicago® Grips	244	H	
Apron, Electrician's Tool	186	Crimping Tools	60, 61, 275	Hacksaw, Dual-Purpose	292
Aprons, Aerial	220	Crimping/Cutting Insulated	74, 75	Hacksaws	292
Armored Cable Cutter	164	Cushion Grip Nut Driver Sets	107-109	Hammers	266, 267, 277, 304-306
ASCR (Aluminum Conductor Steel Reinforced)	232-235	Cushion Grip Nut Drivers	110	Handles, Conduit Bender	164
Aviation Snips	270	Cushion Grip Screwdriver Set	87-90	Hard Hats, Caps and Accessories	169-171
Awls	115	Cutters, Bolt	68, 69	Heavy Duty Tie Wire Belts, Ironworker's	197
B		Cutters, Cable	63-68	Hex-Key Sets	139-147
Bag's, Electrician's	201-204	Cutters, PVC	165	Hex-Key Wrenches	139
Bags, Storage	200-213	Cutters, Tube	274	Hex-Keys, Folding	144
Bags, Tool	200-211	Cutters, Wire	56, 57, 58, 59	Hex-Keys, L-Style	145-147
Bar, Grizzly®	256	Cutting & Notching Tools	270-274	Hex-Keys, T-Handle	140-143
Bars, Connecting	257	D		Hole Saw Kit, Electrician's	281
Bars, Construction	256-260	Diagonal Cutting Pliers	11-12	Hole Saw Kit, Journeyman™	281
Bars, Mining	262	Disposable Dust Mask	169	Hole Saw Kits	281
Belts, Tool	196, 197	Drill Bit Sets	288	Hole Saws	282, 283
Bender, Tube 4-in-1	273	Drill Bits, Flexible	279	Hole-Saw Arbors and Accessories	283
Benders, Conduit	163	Drivers, Magnetic Hex	275	Hooks, Lineman	220
Benders, Tube	273	Dual-Purpose Hacksaw	292	I	
Bent, Trimmers	303	Duct Stretching & Slitting Tools	275	Industrial High-Leverage Shears	302
Bit Set, Magnetic Screwdriver	99	E		Industrial Utility Snips	303
Bits, Carbide-Tipped Masonry	289	Electrical Test & Measurement	308	Insulated Cable Cutters	74, 75
Bits, Drill	288-289	Electrical Testers	317-319, 322-324	Insulated Crimping/Cutting	74, 75
Bits, Replacement	98	Electrician's Bags	201-204	Insulated Diagonal Cutting Pliers	72, 73
Bits, Ship-Auger	287	Electrician's Insulated Cable Cutters	77, 78	Insulated Lineman's Skinning Knife	80
Bits, Step-Drill	286	Electrician's Insulated Pliers	76, 77, 78	Insulated Long-Nose Pliers	78
Block and Tackle	223-226	Electrician's Tool Apron	186	Insulated Nut Drivers	80
Bolt Cutters	68, 69	Electrician's Tool Belt, Tradesman Pro™	191	Insulated Pliers	72, 73, 74
C		Electrician's Hole Saw Kit	281	Insulated Pump Pliers	74
Cable Benders	69	Electrician's Scissors	302	Insulated Screwdrivers	79, 80



Alphabetical Index

Item	Page	Item	Page	Item	Page
Insulated Side-Cutting Pliers	72, 73	Metal Tool Boxes	212, 213	Pliers, Journeyman™, Diagonal Cutting	27
Insulated Strippers	75, 78	Meters, Clamp	313-315	Pliers, Journeyman™, Long Nose	27-28
Insulated Tool Kits	81-84	Meters, Specialty Clamp	316	Pliers, Journeyman™, Side Cutting	25-26
Insulated Tools	72-76	Midget Pliers	14, 15 18-20	Pliers, Lightweight Flush Cutter	15
Insulated Wire Stripper/Cutter	75, 78	Mining & Heavy Industry Tools	259-268	Pliers, Lineman's	9
Interchangeable Jaw Grips & Liners	247	Mining Bars	262	Pliers, Long-Nose	16-17
Introduction – Wire-Mesh Grips	249-252	Multi-Bit Nut Drivers	96, 97	Pliers, Midget	14, 15, 18, 20
Introduction to Wire Pulling Grips	228, 229	Multi-Bit Nut Drivers Replacement Parts	98	Pliers, Pump	22
Ironworker's Heavy Duty Tie Wire Belts	197	Multi-Bit Screwdriver Replacement Parts	98	Pliers, Side-Cutting	8-11
Ironworker's Pliers	10, 11	Multi-Bit Screwdriver Sets	99	Pliers, Slip Joint	21
J		Multi-Bit Screwdrivers	96, 97	Pliers, Special Use	20, 21
Jab Saw	293	Multimeters	309-316	Pliers, Special Use, Long-Nose	20
Journeyman's™ Hole Saw Kit	281	Multimeters, Professional Series	309-312	Pliers, Universal Side Cutting	72
Journeyman™ Crimping Tool	28	Multi-Bit Power Drivers	119	Pocket Knives	296
Journeyman™ Gloves	172-175	N		Pocket Knives, Three Blades	298
Journeyman™ Long Nose Pliers	16, 28	Non-Contact Voltage Testers	318	Pocket Knives, Two Blades	298
Journeyman™ Pliers	25-28	Nut Driver Set, Plastic Handle	111-113	Power Conduit Reamer	94
Journeyman™ Pump Pliers	28	Nut Driver Sets	99, 107-109, 111-113	Power Conduit Reamer	120
Journeyman™ Screwdriver Sets	101	Nut Driver Sets, Cushion Grip	107-109	Power Drivers	120
Journeyman™ Screwdrivers	100	Nut Drivers	96, 97, 98, 99, 107-110	Power Drivers, Multi-Bit	119
Journeyman™ Snips	270	Nut Drivers, Cushion Grip	110	Power Nut Drivers	121
Journeyman™ Cable Cutter	28	Nut Drivers, Insulated	80	Power Tool Accessories	118-121
Journeyman™ Crimping Pliers	28	Nut Drivers, Multi-Bit	96, 97	Powerline™ Series	193
Journeyman™ Diagonal Cutting Pliers	27	Nut Drivers, Plastic Handle	114	Powerline™ Series Padded Suspenders	195
Journeyman™ Long Nose Pliers	27-28	Nylon Fish Tapes	156	Powerline™ Series Padded Tool Belts	194
Journeyman™ Side Cutting Pliers	25-26	Nylon Tie Tensioning Tools	276	Powerline™ Series Tool Pouches	193
K		O		Powerline™ Series Web Work Belt	194
Katapult Wire Stripper/Cutter	58	Offset Screwdrivers	106	Professional Series Multimeters	309-312
Knives and Cutting Tools	295-304	Offset Snips	270-271	Protective Equipment, Personal	167-178
Knives, Pocket	296	Open-End Wrenches	129	Pulling Grips	280
Knives, Special Purpose	300	P		Pump Pliers, Insulated	74
Knives, Utility	299	Padded Suspenders, Powerline™ Series	195	Punches	307
Knockout Punch Set	285	Padded Suspenders, Tradesman Pro™	191	PVC Cutters	165
Knockout Punch Set with Wrench	285	Padded Tool Belts, Powerline™ Series	194	R	
Knockout Punches	285	Personal Protective Equipment	167-178	Ratcheting Box Wrench Sets	134
L		Pins	257	Ratcheting Cable Cutters	66-68
LAN Scout™ Jr. Tester	145-147	Plastic Handle Nut Driver Sets	111-113	Ratcheting Offset Box Wrenches	135
L-Style Hex-Keys	145-147	Plastic Handle Nut Drivers	114	Rebar Hickeys	256
Leather Tool Bags	209	Plastic Handle Screwdrivers	102, 103	Reciprocating Saw Blades	294
Levels	149, 150	Pliers	8-22, 72-74, 76-78	Refrigeration Wrenches	276
Lineman Accessories	220	Pliers Journeyman™, Pump	28	Replacement Parts, Multi-Bit Screwdriver/Nut Drivers	98
Lineman Buckets	215-219	Pliers, 2000 Series® 8, 12, 25-27, 64, 72, 73, 76, 77, 162	10	Right Angle Snips	270-271
Lineman Buckets, Canvas	215-218, 219	Pliers, Combination	10	S	
Lineman Buckets, Hard Body	218	Pliers, Conduit	162	Safety Products	178
Lineman Hooks	220	Pliers, Diagonal Cutting	11-12	Safety Punches	267
Lineman Slings	220	Pliers, Diagonal-Cutting	11-14	Saw Blades, Reciprocating	294
Lineman's Pliers	9	Pliers, Electronics	14, 15	Saw, Jab	293
Lineman's Skinning Knife, Insulated	80	Pliers, Electronics, Long Nose	18-20	Saw, Magic-Slot Compass	293
Lockouts	178	Pliers, Fish Tape Pulling	9, 162	Saws & Blades	292
Long-Nose Pliers	16-17	Pliers, Handles	23	Saws, Hole	282, 283
Long-Nose Pliers, Insulated	74	Pliers, Insulated	72, 73, 74	Schrader® Valve Removal/Installation Bit 11-in-1	97
Lubricants Wire Pulling	161	Pliers, Insulated Diagonal Cutting	72, 73	Scissors, Electrician	302
M		Pliers, Insulated Side-Cutting	72, 73	Screwdriver 11-in-1	97
Magic-Slot Compass Saws	293	Pliers, Ironworker's	10, 11, 13, 14	Screwdriver Sets, Magnetic	99
Magnetic Hex Drivers	275	Pliers, Journeyman™	25-28	Screwdriver Sets, Multi-Bit	99
Magnetic Screwdriver Bit Set	99	Pliers, Journeyman™, Cable Cutter	28	Screwdriver, 10-in-1	97
		Pliers, Journeyman™, Crimping	28	Screwdriver, 4-in-1	104



Alphabetical Index

Item	Page	Item	Page	Item	Page
Screwdriver, 5-in-1	97	Tapes, Warning	178	Tube Flaring & Swaging Tools	274
Screwdriver, Conduit-Fitting and Reaming	94	Tapping Tools	115	Types of Jaw Contours	231
Screwdriver/Nut Driver Folding 10-in-1	97	Telecom Tools	30-32	Types of Wire Pulling Grips	230
Screwdrivers	79, 80 86-106	Test & Measurement Line Accessories	324-326	Tyre Products	268
Screwdrivers Plastic Handle Sets	102	Testers, Electrical	317-319	U	
Screwdrivers, Cushion Grip	87-93	Testers, Electrical	322-324	Universal Compression Connectors	43
Screwdrivers, Cushion Grip	87-93	Testers, Non-Contact Voltage	318	Universal Compression Connectors, BNC	43
Screwdrivers, Insulated	79, 80	Testers, Specialty	319-321	Universal Compression Connectors, F	43
Screwdrivers, Journeyman™	100, 101	Tire Wire Reel	256	Universal Compression Connectors, RCA	43
Screwdrivers, Multi-Bit	96, 97	Tool Bag, Accessories	211	Universal Side-Cutting Pliers	72
Screwdrivers, Multi-Bit	96, 97	Tool Bags	200-211	Utility Knife, Auto Loading Retractable	300
Screwdrivers, Offset	106	Tool Bags, Canvas	205, 206	Utility Knife, Folding	300
Screwdrivers, Plastic Handle, Specialty	104, 105	Tool Bags, Leather	209	Utility Knife, Folding Retractable	300
Screwdrivers, Specialty	94, 95, 276	Tool Bags, Totes	208	Utility Knife, Klein Kurve® Retractable	300
Seaming & Folding Tools	272, 273	Tool Bags, Tradesman Pro™	201-204	Utility Knives	299, 300
Sets, Tool	328	Tool Bags, Vinyl	207	Utility Knives and Blades	299, 300
Sharpening Tools	299	Tool Belts	196-197	V	
Shears, Industrial High-Leverage	302	Tool Belts and Pouch Sets	197	Video Borescope	321
Sheet Metal Fasteners	275	Tool Boxes, Metal	212, 213	Vinyl Tool Bags	207
Sheet Metal Tools/HVAC	269	Tool Combination Apron	186	Voice/Data/Video Connectors	43-45
Ship-Auger Bits	287	Tool Guards	190	Voice/Data/Video Tester Kits	48, 49, 50, 51, 54
Side-Cutting Pliers	8-11	Tool Holders	186-190	Voice/Data/Video Testers	52, 53, 54
Slide Racks	212, 213	Tool Kits, Insulated	81-84	Voice/Data/Video Tool Kits	46, 47
Slings, Lineman	220	Tool Pouches	180-185	Voice/Data/Video Tools	34-42
Snips	270, 271	Tool Pouches, Powerline™ Series	193	W	
Snips, Aviation	270	Tool Set, 12-Piece Electrician	331, 332	Warning Tapes	178
Snips, Industrial Utility	303	Tool Set, 14-Piece Electrician	331	Web Work Belt, Powerline™ Series	194
Snips, Journeyman™	270-271	Tool Set, 18-Piece Journeyman™	330	Wide Range of Cables	245-246
Snips, Offset	270-271	Tool Set, 28-Piece Electrician	329	Wire Cutters	56, 57, 58, 59
Snips, Right Angle	270-271	Tool Set, 41-Piece Journeyman™	328	Wire Mesh Grips	253, 254
Socket Wrench Sets	130, 131	Tool Sets	328	Wire Pulling Grips	243-254
Socket Wrenches	132, 133	Tools, Awls	115	Wire Pulling Grips Accessories	248
Special-Purpose Knives	276	Tools, Combination	60	Wire Pulling Lubricant	161
Specialty Clamp Meters	316	Tools, Conduit	162-164	Wire Pulling Supplies	162
Specialty Plastic Handle Screwdrivers	104	Tools, Conduit Scoring	164	Wire Stripper/Cutter, Katapult	58
Specialty Screwdrivers	276	Tools, Construction	263	Wire Strippers	56, 57, 58, 59
Specialty Screwdrivers	94, 95	Tools, Crimping	275	Wrench Sets	126-134
Specialty Screwdrivers	94, 95	Tools, Cutting & Notching	270	Wrench Sets, Ratcheting Box	134
Specialty Testers	319-321	Tools, Cutting & Notching	270-272	Wrenches	123-138
Specialty Wrenches	136, 137	Tools, Duct Stretching	275	Wrenches, 3-in-1 Impact Socket	136
Spring Tool Set	116	Tools, Duct Stretching & Slitting	275	Wrenches, Adjustable	124, 125
Spring Tools	116	Tools, Nylon Tie Tensioning	276	Wrenches, Combination	126-128
Steel Construction Tools	255	Tools, Seaming & Folding	272	Wrenches, Construction	135-137, 258
Steel Fish Tapes	157	Tools, Sharpening	299	Wrenches, Hex-Key	139
Steel Strand – Chicago® Grips	243	Tools, Slitting	275	Wrenches, Open-End	129
Steel Strand – Haven's® Grips	244	Tools, Spring	116	Wrenches, Ratcheting Box Sets	133, 134
Step-Drill Bits	286	Tools, Steel Construction	255	Wrenches, Ratcheting Offset Box	135
Storage Bags	200-213	Tools, Tapping	115	Wrenches, Refrigeration	276
Strap Wrenches	138	Tools, Tube Flaring & Swaging	274	Wrenches, Socket	132, 133
Stripper/Cutters, Insulated	75, 78	Torque Wrenches	138	Wrenches, Socket Sets	130, 131, 131
Strippers, Insulated	75, 78	Tradesman Pro™	191-192	Wrenches, Specialty	136, 137
Strippers, Wire	56, 57, 58, 59	Tradesman Pro™ Organizer - Electrician's Tool Belt	191	Wrenches, Strap	138
Swaging Tool – Punch Type	274	Tradesman Pro™ Organizer Bags	201-204	Wrenches, Torque	138
T		Tradesman Pro™ Padded Suspenders	191		
T-Handle Hex-Keys	140-143	Tube Benders	273		
Tape Measures	151-153	Tube Cutter Accessories	274		
Tape Measures, Fiberglass	153	Tube Cutters	274		



Numerical Index

Item	Page	Item	Page	Item	Page
A 000	103	1001	59	1106	189
VDV 001-081	39	KSCK-100-1	254	11061	59
VDV 002-818	47	KSSK-100-1	254	11063W	58
VDV 002-820	47	KPS-100-2	254	11073	58
JSDS 01	100	KP-100-24	253	11081	58
V 01	105	1003	58	11082	58
A 010	102	KPS-100-3	254	BD 111	103
VDV 012-811	46	KP-100-36	253	VDV 113-021	35
JSDS 02	101	1004	58	VDV 113-022	35
V 02	105	1005	60	VDV 113-802	35
VDV 026-049	30	1005-INS	74	VDV 113-804	35
VDV 026-049	31	J 1005	28	PH 1-1-5	120
VDV 026-049	38	J 1005	60	SQ 1-1-5	120
VDV 026-812	46	1006	60	S 116	114
VDV 027-813	46	VDV 100-801	35	A 116-2	102
V 03	105	1010	59	A 116-3	102
V 04	105	1011	58	A 116-4	102
V 05	105	1016	60	BL 12	146
KPM-050	253	S 1018	114	BLK 12	145
KPS 050	280	S 1018M	114	LL 12	147
KPS-050-2	254	S 1018M	114	LLK 12	146
DK 06	276	S 106	114	P 12	102
KPS-062-2	254	S 106M	114	S 12	114
KPM-075	253	S 11	114	S 12H	138
KPS 075	280	1100L	271	SS 12	113
KSSK-075-1	254	J 1100L	270	P 120	105
KPS-075-2	254	VDV 110-003	35	1200BI	293
KP-075-24	253	VDV 110-004	35	1200BI-P	293
KP-075-36	253	VDV 110-020	35	CL 1200	315
NCVT-1	318	VDV 110-046	58	VDV 120-005	35
10	147	VDV 110-061	34	VDV 120-006	34
BL 10	146	VDV 110-095	34	12098	10
BLM 10	146	1101R	271	12098-EINS	77
BLMK 10	145	J 1101R	270	12098-INS	72
LLM 10	147	1102S	271	J 12098	26
LMK 10	146	J 1102S	270	PND 1210	121
S 10	114	1104	64	1218BI	293
S 10M	114	11045	57	1218BI-P	293
SS 10	113	11045-INS	75	BD 122	103
CL 100	315	11046	57	1224BI	293
ET 100	317	11047	57	1224BI-P	293
KPJ-100	253	11048	57	1232BI	293
KPM-100	253	11049	57	1232BI-P	293
MM 100	312	11049-INS	75	PND 125	121
RT 100	322	11053	56	KPL-125-1	253
1000	59	11054	56	KSSK-125-1	254
CL 1000	315	11054-EINS	78	KPS-125-2	254
IR 1000	319	11055	56	S 126	114
MM 1000	312	11055-INS	75	S 126M	114
MM 1000N	312	11057	56	CL 1300	315



Numerical Index

Item	Page	Item	Page	Item	Page
MM 1300	312	BL 16	146	1628-30R	241
MM 1300N	312	K 16	105	1628-30S	235
A 130-2	102	LL 16	147	1628-30S	241
A 130-3	102	S 16	114	1628-30T	235
A 131-2	102	1604-10	244	1628-30T	241
BD 133	103	1604-20	244	1628-30U	235
PH 1-35-5	120	1611-20	242	1628-30U	241
SQ 1-35-5	120	1611-30	242	1628-40A	235
BL 14	146	1611-40	242	1628-40A	241
K 14	105	1611-50	242	1628-40U	235
LL 14	147	1613-30	244	1628-40U	241
S 14	114	1613-40	243	1628-40VRU	235
K 1412	56	PH 1-6-2	120	1628-40W	235
K 1412CAN	56	SQ 1-6-2	120	1628-40W	241
SL 14-1-5	120	1625-20	230	1628-40X	235
BD 143	103	1625-20	244	1628-40X	241
SL 14-35-5	120	1625-20 1	244	1628-40Y	235
BD 144	103	1625-20 7/8	244	1628-40Y	241
BD 146	103	1628-16	243	1628-40Z	235
S 146	114	1628-16AT	32	1628-40Z	241
BLM 15	146	1628-16AT	243	1628-50	236
LLM 15	147	1628-16P	239	1628-50A	241
KN 1500P-EX	226	1628-16PE	233	1628-50B	241
KPL-150-1	253	1628-16PE	239	1628-50D	241
KPS-150-2	254	1628-16PF	233	1628-50E	241
KPS-150-3	254	1628-16PF	239	1628-50P	241
KP-150-36	253	1628-16PG	233	1628-50R	241
KT 151T	136	1628-16PG	239	1628-50S	241
1515-S	301	1628-16PH	233	1628-50T	241
1515-1	301	1628-16PH	239	1628-50U	241
KT 155HD	136	1628-16PI	233	1628-50W	241
KT 155T	136	1628-16PJ	233	1628-50X	241
1550-10	298	1628-16PJ	239	1628-50Y	241
1550-11	297	1628-16PK	233	1628-50Z	241
1550-14	297	1628-16PK	239	1628-60	247
1550-2	298	1628-16PL	233	1628-80	247
1550-24	297	1628-16PL	239	1656-20	233
1550-4	297	1628-16PM	233	1656-20	239
1550-42	298	1628-16PM	239	1656-20	242
1550-44	297	1628-16PN	233	1656-30	230
1550-45	297	1628-16PN	239	1656-30	233
1550-5	297	1628-17	243	1656-30	239
1550-6	298	1628-18	243	1656-30	242
1550-7	298	1628-30	241	1656-40	233
1550-9	298	1628-30N	233	1656-40	239
BD 156	103	1628-30N	239	1656-40	242
1560-3	301	1628-30O	233	1656-50	233
1570-3	301	1628-30O	239	1656-50	239
1570-3LR	301	1628-30P	235	1656-50	242
1571-INS	80	1628-30R	235	1656-60	233



Numerical Index

Item	Page	Item	Page	Item	Page
1656-60	239	BL 2	146	VDV 201-040	42
1656-60	242	BLM 2	146	VDV 201-042	42
1659-20	242	LL 2	147	2012	220
1659-30	242	LLM 2	147	201-7CST	11
1659-40	242	NCVT- 2	318	D 201-7CST	11
1659-5AT	32	NHRDA 2	136	D 201-7NE	10
1659-5AT	243	NRHD 2	136	D 201-8	10
1659-50	242	BL 20	146	D 201-8NE	10
1671-10	246	LL 20	147	D 201-9	10
1672-10	246	S 20	114	D 201-9NE	10
1684-5	243	CL 200	315	D 202-6	13
1684-5AT	32	ET 200	317	D 202-6C	13
1684-5AT	243	MM 200	312	203-6-EINS	78
1684-5F	243	RT 200	322	D 203-6	17
1684-74	243	CL 2000	315	D 203-6-INS	74
1685-20	246	IR 2000	319	D 203-6C	17
1685-31	246	IR 2000N	319	D 203-6SCPC	19
1686-10	246	MM 2000	312	J 203-6	28
1686-20	246	MM 2000N	312	D 203-6H2	31
1692-5	243	2000-28-EINS	77	203-7-EINS	78
1692-5AT	32	D 2000-28	12	D 203-7	17
1692-5AT	243	D 2000-28-INS	72	D 203-7-INS	74
1692-5AT	243	J 2000-28	27	D 203-7C	17
1702-20N	226	2000-48-EINS	77	J 203-7	28
T 1710	61	D 2000-48	12	203-8-EINS	78
T 1715	61	D 2000-48-INS	73	D 203-8-INS	73
P 18	103	J 2000-48	27	D 203-8N	16
S 18	114	D 2000-7	8	D 203-8N-INS	73
S 18H	138	D 2000-7CST	11	D 203-8NCR	16
1802-30	224	D 2000-8	8	J 203-8	27
1802-30S	224	J 2000-8	26	J 203-8N	27
H 1802-30	225	2000-9NE-EINS	76	VDV 205-035	42
H 1802-30 S	225	D 2000-9NE	8	VDV 205-036	42
1802-30 S/R	224	D 2000-9NE-INS	72	VDV 205-039	42
1802-30S S/R	224	D 2000-9NECR	9	VDV 205-044	42
H 1802-30 S/R	225	D 2000-9NETH	9	D 206-8C	27
H 1802-30S S/R	225	D 2000-9NETP	162	J 2068C	16
1803-60	226	D 2000-9ST	10	D 209-4C	15
1804-60	226	HD 2000-9NE	8	K 21	105
K 19	105	J 2000-9NE	25	2100L	271
19351	94	J 2000-9NECR	25	J 2100L	271
19352	94	J 2000-9NECRTP	26	2100-5	302
19353	94	J 2000-9NECRTP	162	2100-7	302
19353	94	J 2000-9NETP	25	2100-8	302
19353	94	J 2000-9NETP	162	2100-9	302
19353	162	KPL- 200-1	253	2101R	271
19542	93	J 2001-7NE	26	J 2101R	271
19543	93	KPS- 200-2	254	210122	106
19544	93	KPS- 200-3	254	2102S	271
19555	89	2006	61	J 2102S	271



Numerical Index

Item	Page	Item	Page	Item	Page
2103	271	D 220-7	13	D 252-6SW	13
J 2103S	270	D 220-7-INS	73	25450	248
J 2104L	270	KT 223X4	137	D 257-4	14
J 2105R	270	KT 223X4-INS	137	D 257-4C	14
D 210-6C	14	VDV 226-011	38	258	223
J 2106S	271	VDV 226-011	38	259	223
VDV 211-037	42	VDV 226-817	47	D 259-4C	15
VDV 211-038	42	D 227-7C	21	PH 2-6-2	120
VDV 211-041	42	D 228-7	12	SQ 2-6-2	120
VDV 211-043	42	D 228-8	12	267	223
VDV 211-048	37	D 228-8-INS	72	H 267	223
VDV 211-063	37	J 228-8	27	268	223
PH 2-1-15	120	D 2291	30	H 268	223
SQ 2115	94	D 2291	31	27400	256
SQ 2-1-15	120	K 23	105	27450	190
VDV 212-008	37	CL 2300	315	D 275-5	15
VDV 212-034	42	MM 2300	312	K 28	105
213-8NE-EINS	76	MM 2300N	312	BD 284	103
D 213-8NE	8	23008	303	BD 286	103
D 213-8NE	30	23010	303	D 295-4C	15
J 213-8NE	25	23011	303	BLM 3	146
213-9NE	8	23015	303	LLM 3	147
213-9NE-EINS	76	D 230-4C	15	CL 3000	316
213-9ST	10	D 232-8	21	IR 3000	320
D 213-9	8	SK 234	104	IR 3000N	320
D 213-9NE	8	D 234-6	30	KPS-300-2	254
D 213-9NE	30	D 234-6	30	D 301-5C	17
D 213-9NE-INS	72	D 234-6C	30	D 301-6	17
D 213-9NECR	9	PH 2-35-5	120	D 301-6	29
D 213-9NECR-INS	72	SQ 2-35-5	120	D 301-6C	17
D 213-9NETH	9	D 238-8	12	D 301-7C	17
D 213-9NETP	162	BL 24	146	DTL 302	320
D 213-9ST	10	LL 24	147	D 302-6	20
HD 213-9NE	8	24000	303	DTL 304	320
HD 213-9NETH	9	24001	303	BD 306	103
J 213-9NE	25	24005	303	D 307-5 1/2C	18
J 213-9NECR	25	D 240-6	14	BD 308	103
J 213-9NETP	25	D 243-8	12	3100	272
J 213-9NETP	162	D 244-5C	14	CL 3100	316
A 216-10	103	D 245-5	13	3101	272
A 216-2	103	D 245-5	30	D 310-6C	18
A 216-3	103	D 245-5C	13	31084	294
A 216-4	103	D 248-8-INS	73	VDV 312-012	36
A 216-6	103	J 248-8	27	3146B	32
A 216-8	103	D 248-9ST	13	3146B	136
CL 2200	315	BLM 25	146	PH 3-1-5	120
22000	302	LLM 25	147	SQ 3-1-5	120
22001	302	CL 2500	315	31510	282
22002	302	KPS-250-2	254	31512	282
22003	302	D 252-6	13	31514	282



Numerical Index

Item	Page	Item	Page	Item	Page
31516	282	31734	294	3212	258
31518	282	31734-15	294	3213	137
31520	282	31738	294	3213	258
31522	282	31738-15	294	3214	137
31524	282	31742	294	3214	258
31526	282	31742-15	294	D 321-4 1/2C	18
31528	282	31746	294	3219	137
31532	282	31746-15	294	3219	258
31534	282	D 317-5C	19	3220	137
31536	282	31750	294	3220	258
31538	282	31750-15	294	3221	137
31540	282	31754	294	3221	258
31542	282	31756	294	32215	95
31544	282	31758	294	32216	95
31548	282	31758-15	294	3222	137
31552	282	31762	294	3222	258
31556	282	31764	294	3223	137
31558	282	31766	294	3223	258
31558	282	31802	294	3224	137
31564	282	31806	294	3224	258
31566	282	31808	294	D 322-4 1/2C	18
31572	282	31810	294	3227	125
31576	282	31832	294	3227	137
31580	282	31834	294	3227	258
31596	282	31836	294	3231	137
31600SEN	282	31838	294	3231	258
31606	282	31840	294	3232	137
SL 316-1-5	120	D 318-5 1/2C	19	D 323-4 1/2C	18
31630	281	31850	284	3238	137
31635	281	31852	284	3238	258
SL 316-35-5	120	31854	284	3239	125
31640	281	31856	284	3239	137
31645	281	31857	284	3239	258
31650	283	31858	284	32392	98
31655	283	31860	284	32394	98
31660	283	31862	284	32395	98
31665	283	31864	284	32396	98
31670	283	31866	284	32397	98
31710	294	31868	284	32398	98
31710-15	294	31870	284	32399	98
31714	294	31872	284	3240	257
31716	294	31873	284	32400	98
31716-15	294	CL 3200	316	32401	98
31720	294	CL 3200N	316	3241	257
31722	294	D 320-4 1/2C	20	32410	98
31722-15	294	3210	137	32411	98
31722-50	294	3210	258	32412	98
31728	294	3211	137	3242	257
31728-15	294	3211	258	3243	257
31728-50	294	3212	137	3244	257



Numerical Index

Item	Page	Item	Page	Item	Page
3245	257	32560	96	40012	176
3246	257	32561	96	40014	176
32460	104	32562	96	40015	176
3247	257	3257	257	40016	176
32473	104	3258	257	40017	176
32476	97	3259	257	40018	176
32477	97	3260	257	40020	176
32478	98	32605	119	40021	176
32478	104	32606	119	40022	176
32479	98	3261	257	40030	174
32479	104	3262	257	40031	174
3248	257	3263	257	40032	174
32482	98	3265	257	40034	174
32483	98	VDV 327-103	41	40035	174
32484	98	D 327-5 1/2C	18	40036	174
32485	98	32759	121	40038	174
32500	97	D 328-5 1/2C	19	40039	174
3251	257	D 333-8	162	40040	174
32510	99	33525	82	40042	174
3252	257	33525SC	82	40043	174
32525	99	33526	83	40044	174
32526	99	33527	81	40052	175
32527	97	33528	84	40053	175
32527	276	33529	83	40054	175
32534	97	33532-INS	80	40057	175
32535	97	PH 3-35-5	120	40058	175
32536	97	SQ 3-35-5	120	40059	175
32537	97	D 335-5 1/2C	19	40062	175
32538	97	K 34	105	40063	175
32539	97	P 340	105	40064	175
32540	98	3416	136	40067	175
32541	98	3416A	136	40068	175
32542	98	KPS 350-2	254	40069	175
32543	98	K 36	105	40072	177
32544	98	PH 3-6-2	120	40074	177
32545	98	SQ 3-6-2	120	40080	177
32546	98	D 366-6C	20	40082	177
32547	98	K 38	105	40084	177
32548	98	BL 4	146	40086	177
32549	98	BLM 4	146	40205	172
3255	257	LL 4	147	40206	172
32550	98	LLM 4	147	40207	172
32551	98	ST 4	116	40208	172
32552	98	40001	177	40209	172
32553	98	40002	177	40210	172
32554	98	40003	176	40211	172
32557	96	40004	176	40212	172
32558	96	40006	176	40213	172
32559	96	40008	176	40214	173
3256	257	40010	176	40215	173



Numerical Index

Item	Page	Item	Page	Item	Page
40216	173	42245	185	KT 4501	245
40217	173	42246	185	KT 4502	245
40218	173	42247	183	45200	178
40219	173	4BP25	262	45201	178
40220	173	4HT25	104	455	223
40221	173	4HT27	104	K 46	105
40222	173	VDV 427-015	41	KT 4600	245
JSD 4C06	101	VDV 427-016	41	KT 4601	245
JTH 4E06	140	VDV 427-017	41	KT 4602	245
JTH 4E06	141	VDV 427-018	41	46037	301
JTH 4E07	140	VDV 427-104	41	46039	301
JTH 4E07	141	VDV 427-800	40	KT 4650	245
JSD 4K08	101	VDV 427-805	40	KT 4652	245
JTH 4E08	140	VDV 427-806	40	470	226
JTH 4E08	141	VDV 427-807	39	K 48	105
JTH 4E09	140	VDV 427-807	40	KT 4800	245
JTH 4E09	141	VDV 427-822	39	KT 4801	245
JSD 4PH1	101	4HS316	104	KT 4802	245
4BP10	262	K 44	105	48036	299
JTH 4E10	140	44000	296	48502	223
JTH 4E10	141	44000-BLK	296	ST 49	116
JTH 410E	140	44001	296	4HS932	104
JTH 410E	141	44001-BLK	296	5SDR	265
4H1R1	104	44002	296	5SDSH	265
JTH 4E11	140	44003	296	5WHRG	267
JTH 4E11	141	44004	296	BL 5	146
4BP12	262	44005	296	BLM 5	146
4H1P2	104	44006	296	LL 5	147
4H1R2	104	44007	296	LLM 5	147
JTH 4E12	140	44031	296	S 5	114
JTH 4E12	141	44032	297	KPJ- 50	253
4H1R3	104	44033	297	ET 500	321
JTH 4E13	140	44034	297	MM 500	312
JTH 4E13	141	44035	297	RT 500	322
JTH 4E14	140	44036	297	MM 5000	312
JTH 4E14	141	44037	297	MM 5000N	312
4HT15	104	44100	299	VDV 500-051	53
JTH 4E15	140	44101	299	VDV 500-060	53
JTH 4E15	141	44103	300	500-18	125
4BP16	262	44104	299	500-24	125
JTH 4E17	140	44130	300	5003-18	206
JTH 4E17	141	44131	300	5003-20	206
4BP19	262	44132	300	VDV 500-808	54
JSD 4PH2	101	44133	300	ET 501	321
4HT20	104	44151	299	VDV 501-089	52
42200	186	44200	301	VDV 501-809	50
42201	186	443A	226	VDV 501-814	49
42241	185	4BPSET5	262	VDV 501-814	50
42242	185	KT 4500	230	VDV 501-815	49
42244	185	KT 4500	245	VDV 501-828	48



Numerical Index

Item	Page	Item	Page	Item	Page
VDV 501-829	48	5102-16	205	VDV 512-057	51
502-10-EINS	78	5102-16SP	205	VDV 512-058	51
D 502-10-INS	74	5102-18	205	5121-15	211
J 502-10	28	5102-18SP	205	5121-19	211
D 502-12	22	5102-20	205	5122-16	211
D 502-16	22	5102-22	205	5122-18	211
D 502-6	22	5102-24	205	5124-15	211
D 503-10	22	5102-24SP	205	5124-17	211
D 503-12	22	51028	161	5124-19	211
50350	158	5103S	216	5125	181
50351	158	5104	215	5125L	181
50355	158	5104S	215	5126	181
50400	69	5104VT	215	5127	181
50402	69	5104CLR17	217	5127T	181
D 504-10	22	5104CLR22	217	5129	189
D 504-10B	22	5105-20	205	5130	190
D 504-12	22	5105-24	205	5131	190
D 504-12B	22	5106	215	5136	209
D 504-7	22	5106P	215	5139	210
50500	165	5106S	215	5139B	210
50501	165	5107-6	187	5139C	210
50506	165	5107-9	187	5139L	209
506-15	125	5108-18	209	5139L	210
D 506-4	125	5108-20	209	5139PAD	210
507-10	124	5108-24	209	5140	210
D 507-10	124	5109	215	5140K	180
507-12	124	5109P	215	5141	210
D 507-12	124	5109PS	215	5141P	183
507-6	124	5109S	215	5142	183
D 507-6	124	5109SLR	217	5142P	183
507-8	124	5110-48	219	51425	171
D 507-8	124	5111	180	51427	164
D 509-8	124	511-10	21	51428	164
50992	160	D 511-10	21	51429	164
51A	184	5112	187	5143	219
51TOP	216	5113	216	5144	218
5HCMH1.35	266	5113S	216	5144B	218
5100M	186	5115	209	5144BHB	218
5101	17	D 511-6	21	5144BHHB	218
5101	186	5118C	187	5144H	220
51010	161	5118PRS	187	5144HBS	218
51012	161	5118R	188	5144S	216
51013	161	5118RT	188	5144BHB140S	218
51015	161	5118S	188	5145	180
51017	161	D 511-8	21	5146	183
51018	161	S 5118PRS	187	D 514-8	21
5102S	211	5118P4	188	5CB150025	260
5102-12	205	5118P5	188	5PB150025	261
5102-14	205	5119	181	5CB150030	260
5102-14SP	205	VDV 512-056	51	5PB150030	261



Numerical Index

Item	Page	Item	Page	Item	Page
5151.....	208	5201.....	196	53175.....	289
5152S.....	216	5202L.....	196	53176.....	289
5155.....	206	5202M.....	196	53177.....	289
5156.....	206	5202XL.....	196	53178.....	289
5162T.....	182	5204.....	196	5BD33.....	263
5163.....	186	5225.....	185	5336.....	209
5164.....	182	5225.....	196	53401.....	287
5164T.....	182	5236.....	209	53402.....	287
5165.....	182	5POP25.....	263	53403.....	287
5CB165025.....	260	VDV 526-052.....	52	53404.....	287
5PB165025.....	261	VDV 526-054.....	54	53405.....	287
5CB165030.....	260	VDV 526-055.....	51	53406.....	287
5PB165030.....	261	D 528V.....	30	53407.....	287
5166.....	180	D 528V.....	30	53408.....	287
5167.....	183	5BD30.....	263	53409.....	287
5171PS.....	216	5POP30.....	263	53410.....	287
5172PS.....	216	5300.....	331	53411.....	287
5178.....	180	53000.....	288	53430.....	287
5179.....	184	53001.....	288	53434.....	287
5179S.....	184	53002.....	288	53435.....	287
5180.....	207	53004.....	289	53436.....	287
5CBR180022.....	260	53100.....	289	53437.....	287
5CB180025.....	260	53101.....	289	53438.....	287
5CBR180025.....	260	53102.....	289	53439.....	287
5PB180025.....	261	53103.....	289	53440.....	287
5CB180030.....	260	53104.....	289	53441.....	287
5CBR180030.....	260	53105.....	289	53442.....	287
5GNB180030.....	260	53106.....	289	53443.....	287
5PB180030.....	261	53107.....	289	53444.....	287
5181ORA.....	207	53108.....	289	53445.....	287
5182BLA.....	207	53109.....	289	53446.....	287
51829.....	220	53110.....	289	53715.....	279
51829M.....	220	53111.....	289	53716.....	279
51829MHS.....	220	53112.....	289	53717.....	279
5185.....	187	53113.....	289	53718.....	279
5185ORA.....	207	53114.....	289	53719.....	279
5187.....	186	53115.....	289	53720.....	279
5187T.....	186	53116.....	289	53721.....	280
5188.....	187	53117.....	289	53722.....	279
5188T.....	187	53118.....	289	53723.....	279
5190.....	182	53119.....	289	53725.....	164
5194.....	152	53120.....	289	53727.....	285
5194.....	189	53121.....	289	53728.....	285
5195.....	152	53122.....	289	53731.....	283
5195.....	185	53123.....	289	53732.....	285
5195.....	189	53124.....	289	53751.....	279
5196.....	152	53125.....	289	5POB37516.....	264
5196.....	189	53126.....	289	5POB37520.....	264
5HDRH2.0.....	266	53127.....	289	5415.....	196
5200-15.....	206	53128.....	289	5415L.....	196



Numerical Index

Item	Page	Item	Page	Item	Page
5415S	196	5539YEL	210	56115	159
5415XL	196	55400	191	56116	155
5416	184	55415-8	204	56116	159
5416L	184	55416-10	204	56117	161
5416T	184	55417-18	203	56118	160
5416TC	184	55418-19	203	56120	155
5416TCP	184	55419-SP	204	56120	159
5417	189	55421-BP	203	56125	157
5417T	189	55427	191	56203	163
5420	197	55428	191	56204	163
5420	256	55429	191	56205	163
5420L	256	55452RTB	201	56206	163
5420S	197	55453HSB	201	56207	163
5420S	256	55454DHB	201	56208	163
5420XL	197	55455M	202	56209	163
5420XL	256	55456BPL	202	56210	163
5425M	197	55460	192	56211	163
5425XL	197	55461	192	56240	157
54401	212	5574L	190	56304	159
54445	213	5574S	190	56306	159
54446	213	5TL600	268	56312	159
54447	213	56000	157	56324	159
54448	213	56001	157	56325	159
54451	213	56002	157	56405	159
54474	212	5PB60020	261	56406	159
54476	212	5POB60020	264	56409	159
54477	212	5PB60025	261	56415	159
54484	212	56003	157	56418	159
54486	212	56004	157	5700	193
5PB45016	261	56005	157	57000	138
5POB45016	264	56006	157	57005	138
5PRBP45016	264	56007	157	5701	193
5POB45020	264	56008	157	57010	138
5456	188	56009	155	5702	193
5456T	188	56010	155	5703	193
5456TS	188	56011	156	57034	106
5458	190	56012	156	57036	106
5459T	189	56013	156	5704L	195
5460	189	56014	155	5704M	195
5461T	189	56024	156	5704XL	195
5471	184	56025	156	5705	194
5481	181	5606	220	5706	194
5482	183	56065	157	57060	138
55	23	56104	160	5707	152
5509	190	56105	160	5707	152
55210	197	56106	158	5707	194
5539BLU	210	56107	158	5707	194
5539CPAK	210	56108	162	5708	194
5539NAT	210	56110	162	5709L	195
5539RED	210	56115	155	5709M	195



Numerical Index

Item	Page	Item	Page	Item	Page
5709XL	195	MM 600	312	602-7DD	94
5710L	195	RT 600	322	602-8-INS	79
5710M	195	MM 6000	312	603-1	91
5710XL	195	MM 6000N	312	603-3	91
5712	152	60009	169	603-3B	95
5712	194	VDV 600-096	36	603-4	91
5713	194	600-1	91	603-4-INS	79
5714	194	60010	169	603-4B	95
5716	194	60011	169	603-6	91
5717	195	60015	169	603-7-INS	79
5718	193	60018	170	604-3	92
5719	193	60019	170	605-4B	95
5PB75025	261	60021	170	605-6B	95
5777	208	60022	170	605-7-INS	79
58000	178	60025	170	JSD 6C06	101
58001	178	60027	170	JTH 6E06	141
58002	178	60028	170	JTH 6E06BE	140
58003	178	60030	170	JTH 6E06BE	140
58886	208	60031	170	606-2	92
58888	208	60033	170	JTH 6E07	141
58889	211	60034	170	JTH 6E07BE	140
58890	208	60036	170	JTH 6E07BE	140
59001	286	600-4	91	607-2	92
59001T	286	60046	168	607-3	92
59002	286	60047	168	607-3-INS	79
5POB90020	264	60049	168	607-4	92
5PB90025	261	60053	168	JTH 6E08	141
59003	286	60054	168	JTH 6E08BE	140
59003T	286	60055	168	JTH 6E08BE	140
59004	286	60056	168	608-2	92
59005	286	60057	168	JSD 6K09	101
59005T	286	600-6	91	JTH 6E09	141
59008	286	60060	169	JTH 6E09BE	140
59009	286	60060	169	JTH 6E09BE	140
59009T	286	60080	169	610	108
59011	286	601-10	91	JTH 6E10	141
59014	286	601-3	91	JTH 610E	140
59014T	286	601-4	91	JTH 610E	141
59031	287	601-4-INS	79	JTH 6E10BE	140
59034	287	601-6	91	JTH 6E10BE	140
59985	171	601-7-INS	79	JTH 6M10	143
59990	171	601-8	91	JTH 6M10BE	142
BL 6	146	60210B	198	JTH 6T10	143
BLM 6	146	60223B	198	610-1/4	109
LL 6	147	602-3	91	610-1/4M	110
LLM 6	147	602-4	91	610-3/8M	110
S 6	114	602-4-INS	79	610-5/16	109
S 6H	138	602-4DD	94	610-5/16M	110
ST 6	116	602-6	91	JTH 6E11	141
60	23	602-7-INS	79	JTH 6E11BE	140



Numerical Index

Item	Page	Item	Page	Item	Page
JTH 6E11BE	140	630-10mm	109	632	110
JTH 6E12	141	630-11mm	109	63214	68
JTH 6E12BE	140	630-11/32	109	63218	68
JTH 6E12BE	140	630-11/32M	110	63224	68
612-4	95	63016	64	63230	68
612-4-INS	79	63020	63	63242	68
JTH 6E13	141	63028	64	633	108
JTH 6E13BE	140	630-3/16	109	63314	68
JTH 6E13BE	140	630-3/16M	110	63318	68
613-3	92	630-3/8	109	63324	68
JTH 6E14	141	630-3/8M	110	63330	68
JTH 6E14BE	140	63030	64	63336	68
614-2	92	63035	65	633-4-INS	79
614-3	92	63035SC	65	63342	68
614-4	92	630-4mm	109	633-7-INS	79
614-6	92	630-4.5mm	109	63524	69
JTH 6E15	141	63041	65	63530	69
JTH 6E15BE	140	63041TH	65	63536	69
JTH 6E15BE	140	63045	65	63542	69
JTH 6T15	143	63047	66	63607	67
JTH 6E17	141	630-5mm	109	63700	68
JTH 6E17BE	140	630-5/16	109	63711	66
618-1/4M	110	630-5/16M	110	63750	66
618-5/16M	110	630-5/8	109	63800ACSR	67
JTH 6M2	143	63050	63	63858	67
JTH 6M2BE	142	63050-EINS	77	JTH 6M4	143
JTH 6T20	143	63050-INS	74	JTH 6M4	143
620-3	92	J 63050	28	JTH 6M4BE	142
621-10	92	J 63050	63	JTH 6T40	143
621-6	92	63055	64	640-1/2	110
621-8	92	630-6mm	109	640-1/4	110
623-20	115	63060	66	640-3/16	110
623-24	115	630-7mm	109	640-3/8	110
JTH 6M25	143	630-7/16	109	640-5/16	110
JTH 6M25BE	142	630-7/16M	110	640-5/8	110
JTH 6T25	143	630-8mm	109	640-7/16	110
625-24	115	63081	65	640-9/16	110
625-32	115	630-9/16	109	64306	256
626	115	63090	65	64309	256
JTH 6T27	143	631	107	64310	256
627-20	115	631M	107	64311	256
JSD 6PH3	101	63110	66	64312	256
JTH 6M3	143	63118	68	646M	108
JTH 6M3BE	142	63119	68	646-1/2	109
630M	108	63124	68	646-1/2-INS	80
JTH 6T30	143	63125	68	646-1/2M	110
630-1/2	109	63130	68	646-1/4	109
630-1/2M	110	63131	68	646-1/4-INS	80
630-1/4	109	63136	68	646-1/4M	110
630-1/4M	110	63137	68	646-11/32	109



Numerical Index

Item	Page	Item	Page	Item	Page
646-11/32-INS	80	65620	132	65832	133
646-11/32M	110	65621	132	65907	132
646-3/16	109	65622	132	65908	132
646-3/16-INS	80	65623	132	65909	132
646-3/16M	110	65700	132	65910	132
646-3/8	109	65701	132	65911	132
646-3/8-INS	80	65702	132	65912	132
646-3/8M	110	65703	132	65913	132
646-5/16	109	65704	132	65914	132
646-5/16-INS	80	65705	132	65915	132
646-5/16M	110	65706	132	65916	132
646-5/8	109	65707	132	65917	132
646-5/8-INS	80	65708	132	65918	132
646-7/16	109	65710	132	65919	132
646-7/16-INS	80	65711	132	JTH 6M6	143
646-7/16M	110	65712	132	JTH 6M6BE	142
646-9/16	109	65713	132	S 66	114
646-9/16-INS	80	65714	132	660	92
647	107	65715	132	661	92
647M	107	65716	132	661B	95
JTH 6M5	143	65717	132	66100	307
JTH 6M5BE	142	65720	133	661-4-INS	79
650	115	65721	133	66140	307
65020	116	65722	133	66142	307
65160	108	65723	133	66143	307
65500	131	65724	133	66144	307
65502	130	65800	133	66145	307
65503	131	65801	133	66146	307
65504	131	65802	133	661-7-INS	79
65506	130	65803	133	66174	307
65508	131	65804	133	66177	307
65510	130	65805	133	66183	307
65512	130	65806	133	662	92
65514	130	65807	133	662B	95
65600	132	65808	133	662-4-INS	79
65601	132	65809	133	662-7-INS	79
65602	132	65810	133	663	92
65603	132	65811	133	66310	307
65604	132	65812	133	66311	307
65605	132	65820	133	66312	307
65606	132	65821	133	66313	307
65607	132	65822	133	66320	307
65608	132	65823	133	66321	307
65610	132	65825	133	66322	307
65611	132	65826	133	66323	307
65612	132	65827	133	66324	307
65613	132	65828	133	66325	307
65614	132	65829	133	66340	307
65615	132	65830	133	66342	307
65616	132	65831	133	66343	307



Numerical Index

Item	Page	Item	Page	Item	Page
66344	307	68415	127	69406	192
66385	115	68416	127	69406	326
66400	274	68417	127	69407	192
665	92	68418	127	69407	326
JTH 67T	143	68419	127	69408	192
670-3	93	68420	127	69408	326
670-6	93	68421	127	69410	323
67100	93	68422	127	69411	323
67101	93	68423	127	69412	324
67101	98	68424	127	69413	324
671-6	93	68425	127	69414	324
JTH 68M	142	68450	129	69415	323
JTH 68MB	142	68452	129	69450	324
JTH 6M8	143	68460	129	69451	324
JTH 6M8BE	142	68461	129	69454	324
68005	32	68462	129	69455	324
68005	135	68463	129	69457	324
681-6	93	68464	129	BL 7	146
68200	134	68465	129	DS 7	275
68201	134	68466	129	K 7	112
68202	134	68500	128	LL 7	147
68203	134	68502	128	S 7	114
68204	134	68507	128	70	23
68205	134	68508	128	S 700	112
68206	134	68509	128	70035	104
68221	134	68510	128	70084	111
68222	134	68511	128	701-S	292
68234	135	68512	128	701-10	292
68236	135	68513	128	701-12	292
68238	135	68514	128	702	293
68240	135	68515	128	70200	113
68242	135	68517	128	70204	114
68244	134	68519	128	70205	114
68245	135	69105	322	70206	114
682-6	93	69127	322	70207	114
68309	135	69128	323	70208	114
68309	276	69130	322	70209	114
68310	135	69131	322	70210	114
68310	276	69133	322	70211	114
68310-24	135	69134	323	702-12	292
68310-24	276	69135	323	70220	106
68400	126	691-6	93	70245	114
68402	126	69190	325	70255	114
68404	127	69191	312	703	293
68406	127	69192	312	704	293
68410	127	69193	312	7HBRFRH04	266
68411	127	69194	312	705	293
68412	127	692-6	93	70570	144
68413	127	69400	325	70571	144
68414	127	69401	326	70572	144



Numerical Index

Item	Page	Item	Page	Item	Page
70573	144	76012B	272	VDV 814-633	44
70574	144	VDV 770-050	41	VDV 814-634	44
70575	144	VDV 770-080	51	VDV 814-635	44
70579	144	BL 8	146	VDV 814-636	44
70580	144	BLM 8	146	VDV 814-637	44
70581	144	LL 8	147	VDV 814-638	44
70582	144	LLM 8	147	S 818	114
70583	144	S 8	114	S 818M	114
70586	144	S 8M	114	S 818M	114
70591	144	SS 8	113	818-16	305
706	293	80014	331	818-20	305
707	293	80028	329	820-16	277
7HBRFRH07	266	80118	330	820-16	306
709	293	80141	328	821-12	277
7HBRFRH10	266	803-12	305	821-12	306
7FWSS10025	263	803-16	305	823-48	305
7SC120019	262	803-24	305	VDV 824-632	45
7WRP13	267	803-32	305	VDV 826-600	45
7HBRFRH14	266	803-8	305	VDV 826-601	45
7SC150019	262	807-18	305	VDV 826-602	45
7CHC15013	262	808-16	305	VDV 826-603	45
7WRP16	267	808-20	305	VDV 826-604	45
PND 71610	121	809-36	306	VDV 826-605	45
PND 7165	121	809-36MF	306	VDV 826-611	45
7CHC17516	262	811-16	277	VDV 826-628	45
7SCT1800	261	811-16	306	832-32	305
7SCTH1800	261	811-32	277	85071	90
7SC180019	262	811-32	306	85072	90
7WRP19	267	VDV 812-606	43	85074	88
71980	30	VDV 812-612	43	85075	88
71980	31	VDV 812-615	43	85076	87
7CHC20020	262	VDV 812-618	43	85077	87
7SC210019	262	VDV 812-623	43	85078	87
72192	30	VDV 812-624	43	85091	94
72192	30	VDV 812-625	43	85091	120
7WRP22	267	VDV 812-626	43	85105	88
7SCTH2400	261	VDV 812-627	43	85155	90
7SC240019	262	VDV 813-607	43	85191	94
725	293	VDV 813-608	43	85191	162
7WRP25	267	VDV 813-613	43	85276	102
7BP29219	262	VDV 813-614	43	85484	89
7BP29225	262	VDV 813-616	43	85614	89
7BP29232	262	VDV 813-617	43	85664	90
7WRP32	267	VDV 813-619	43	S 86	114
7SCT3660	261	VDV 813-620	43	S 86M	114
74007	58	VDV 814-609	44	86550	275
74017	60	VDV 814-610	44	86551	272
7SCT4320	261	VDV 814-629	44	86552	272
KPJ -75	253	VDV 814-630	44	86553	272
76011B	272	VDV 814-631	44	86554	273



Numerical Index

Item	Page	Item	Page	Item	Page
86555	273	JTH 9E09	140	NRHDA	136
86556	272	JTH 9E09	141		
86560	272	JTH 9E10	140		
86570	276	JTH 9E10	141		
86571	276	JTH 910E	140		
86600	275	JTH 910E	141		
86600-10	275	JTH 9M10	143		
86601	275	910-6	152		
86601-10	275	JTH 9E11	140		
86602	275	JTH 9E11	141		
86602-10	275	911-6	152		
87904	198	JTH 9E12	140		
87906	198	JTH 9E12	141		
88904	274	JTH 9E13	140		
88905	274	JTH 9E13	141		
88906	164	JTH 9E14	140		
88975	274	JTH 9E14	141		
88976	274	JTH 9E15	140		
88977	274	JTH 9E15	141		
88978	274	PND 91610	121		
88980	273	PND 9165	121		
88981	273	JTH 9E17	140		
88982	273	JTH 9E17	141		
89	23	JTH 9M2	143		
8900-1/2	273	92003	332		
8900-3/8	273	JTH 9M25	143		
89004	112	928-16HV	152		
89018	273	928-25HV	152		
89019	273	JTH 9M3	143		
89020	274	93025	151		
89021	274	930-9	149		
89025	274	93116	151		
89030	273	93125	151		
8910-1/2	275	931-6RE	149		
8910-3/4	275	9317RE	150		
89565	275	931-9RE	149		
89904	113	93225	151		
89969	111	93275	151		
BL 9	146	932-9RE	149		
LL 9	147	9330RE	150		
S 9	114	93430	151		
900-6	152	946-100	153		
901-6	152	946-150	153		
905-6	152	946-50	153		
JTH 9E06	140	JTH 9M5	143		
JTH 9E06	141	JTH 9M6	143		
JTH 9E07	140	JTH 98M	142		
JTH 9E07	141	JTH 9M8	143		
JTH 9E08	140	VDV 999-033	42		
JTH 9E08	141	NRHD	136		



Important information for everyone who uses hand tools...fully illustrated pages of basic facts and practical "how-to" tips.



Prepared by KLEIN TOOLS in conjunction with the Hand Tools Institute. Available from your Klein distributor (Cat. No. 98016).

Warranty

The warranty information on this page may only be applicable in the US and Canada. See www.kleintools.com/warranty for more information.

Warranty

Klein products in this catalog, manufactured and sold for commercial or industrial uses, are warranted to be free from defects in materials and workmanship for the normal life of the product, with the exception of: I. Electronic Test & Measurement products (see warranty below); and II. Ratcheting and Drill-Operated Cable Cutters, which are warranted for one year from the date of purchase. The following consumable products are warranted to be free from defects in materials and workmanship when delivered to the customer: Triple-Taps, Drill Bits, Step Drills, Carbide Hole Cutters, Hole Saws and Arbors; Saw Blades and Jab Saws; disposable Razor and Knife Blades; Stripper Cartridges, Replaceable Cutting Inserts, Bits and Blades; Hand Cleaners and Wire Pulling Lubricant. **THERE ARE NO IMPLIED WARRANTIES OF MERCHANTABILITY OR FITNESS.** At its option Klein will repair or replace, or refund the purchase price of, any product which fails to conform to this warranty under normal use and service. **In no event shall Klein be liable for incidental or consequential damage.**

If your Klein product requires repair or for information on how to exercise your rights under the terms of this warranty, please contact Klein Tools at 1-800-553-4676.

Electronic Test & Measurement Warranty

Klein electronic test and measurement devices (and accessories), manufactured and sold for commercial or industrial uses, are warranted to be free from defects in materials and workmanship for two years from the date of purchase (unless otherwise noted on the product packaging). **THERE ARE NO IMPLIED WARRANTIES OF MERCHANTABILITY OR FITNESS.** At its option, Klein will repair or replace, or refund the purchase price of, any product which fails to conform to this warranty under normal use and service. **In no event shall Klein be liable for incidental or consequential damage.** This warranty does not apply to batteries.

Warranty Returns

All warranty returns must include a Warranty Return Authorization (WRA) number. The WRA for the U.S. can be obtained by calling Customer Service at 1-800-553-4676. (International call 1-847-821-5500) or email serviceonline@kleintools.com.

Specifications of all products in this catalog are subject to change without notice.

Dimensions shown for all forged products in this catalog are as precisely accurate as possible, but subject to very slight variations that are unavoidable in forging and grinding operations. Dimensions of Klein forged tools and all other tools and equipment are always within commercial tolerances recognized for such products.



For over 155 years Klein Tools has remained dedicated to professional tradesmen worldwide, with a commitment to manufacturing the world's finest hand tools right here in America.



Lincolnshire • IL

Committed to American Manufacturing Since 1857



Mansfield • TX

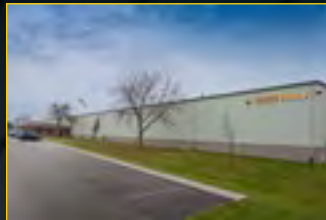

Cedar Rapids • IA



Fort Smith • AR



Elk Grove • IL



Rockford • MI



Bolivar • NY