

ELCO Lighting



MASTER LIGHTING CATALOG

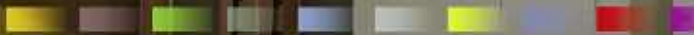

Table of Contents



Line Voltage

- 8" and 7" Architectural Incandescent
- 6" Line Voltage
- 5" Line Voltage
- 4" Line Voltage
- 3" GU10 Line Voltage

3-58



Low Voltage

- 6" Low Voltage
- 5" Low Voltage
- 4" Low Voltage
- 3" Low Voltage

59-95



Compact Fluorescent

- 8" Architectural Compact Fluorescent
- 7" Architectural Compact Fluorescent
- 6" Compact Fluorescent
- 5" Compact Fluorescent
- 4" Architectural Compact Fluorescent



96-144



Commercial Retrofit

- 9" Architectural Compact Fluorescent
- 8" Architectural Compact Fluorescent
- 7" Architectural Compact Fluorescent
- 6" Architectural Compact Fluorescent
- 5" Architectural Compact Fluorescent

145-166



Architectural H.I.D.

- 10" Architectural H.I.D. (MH, HPS)
- 8" Architectural H.I.D. (MH, HPS)
- 6" Architectural H.I.D. (MH)
- 4" Architectural H.I.D. (MH)

167-180

Table of Contents

181-198

Undercabinet Lighting

- Miniature Fluorescent Undercabinet
- Fluorescent Undercabinet Lights
- Incandescent Halogen Undercabinet lights
- Low Voltage Xenon Undercabinet lights
- Decolume Lights
- Mini Low Voltage Halogen Downlights
- Duralight
- Transformer
- Accessories



199-207

Recessed Wall Mount Lighting

NEW!

- Incandescent Diecast Brick Lights
- Compact Fluorescent Diecast Brick Lights
- Incandescent and LED Mini-Step Lights
- Compact Fluorescent Flood Lights
- Incandescent Step Lights
- Compact Fluorescent Step Lights



208-213

Outdoor Lighting

- H.I.D. Wallpacks
- H.I.D. Flood Lights



214-237



Exit Signs and Emergency Lighting

- Exit Signs
- Emergency Lights
- Exit Sign and Emergency Light Accessories
- 8" Compact Fluorescent Emergency Downlights
- 7" Architectural Compact Fluorescent Emergency Downlights



238-249

Accessories

- Adjustable Hole Cutter
- Accessories for Recessed Fixtures
- Recessed and Track Lighting Displays
- Transformers
- Lamps



Line Voltage

Elco Lighting's extensive collection of line voltage products include everything your application requires, including wall-washers, scoops, adjustable gimbals, gimbal/baffle combinations, pinholes, adjustable spots, trendy shower trims and more. Available in 3", 4", 5", 6", 7" and 8" apertures. Our impressive sloped ceiling collection boasts the broadest variety of sloped ceiling trims ever. All product specification sheets can be downloaded from our website at www.elcolighting.com

3-58



8" Architectural Incandescent Downlight

ELH8T

8" Incandescent Downlight

- Recessed Downlight, 8" Commercial frame.
- Galvanized Steel Construction.
- Polycarbonate white trim ring.
- 120V, 200Watts Maximum
- PAR30-PAR38 or A-lamp
- Lamp and Hanger bars not included.

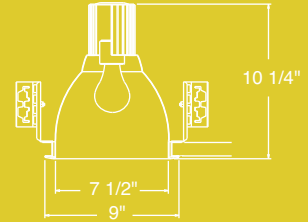

EL 816C

EL 816F (Self flanged)

Reflector Trim
Lamp: 200W Max
PAR38 or A-lamp
OD: 9"



EL 833W

Reflector with Baffle Trim
Lamp: 200W Max
PAR38 or A-lamp
OD: 9"



EL 816G

Reflector Trim
Lamp: 200W Max
PAR38 or A-lamp
OD: 9"



EL 838C

Clear Wall Wash
Reflector Trim
Lamp: 200W Max
PAR38-PAR30 or A-lamp
OD: 9"

NEW!



EL 832C

Regressed Prismatic
lens Chrome Reflector
Lamp: 150W Max
PAR38 or A-lamp
OD: 9"



EL 852B

Regressed Lens
Baffle Trim
Lamp: 150W Max
PAR38 or A-lamp
OD: 9"



EL 832G

Regressed Prismatic lens
Chrome Reflector
Lamp: 150W Max
PAR38 or A-lamp
OD: 9"



EL 852W

Regressed Lens
Baffle Trim
Lamp: 150W Max
PAR38 or A-lamp
OD: 9"



7" Architectural Incandescent Downlight

ELH7T

7" Incandescent Downlight

- Recessed Downlight, 7" Commercial frame
- Galvanized Steel Construction
- 120V, 150 Watts Maximum
- PAR30-PAR38 or A lamp
- Lamp and Hanger bars not included

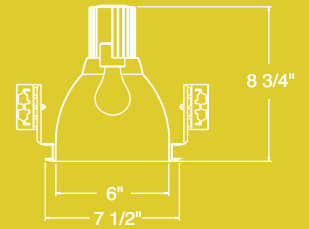

EL 716C

EL 716F (Self flanged)
Specular Clear Reflector
OD: 7 1/2"



EL 733W

Baffle Reflector Trim
OD: 7 1/2"



EL 716G

Specular Reflector
Reflector
OD: 7 1/2"



EL 737C

Clear Wall Wash
Reflector Trim
OD: 7 1/2"

NEW!



EL 732C

EL 732F (Self flanged)
Regressed Fresnel lens
Chrome Reflector
OD: 7 1/2"



EL 752W

EL 752B
Regressed Lens
Baffle Trim
OD: 7 1/2"



EL 732G

Regressed Fresnel lens
Chrome Reflector
OD: 7 1/2"



EL 733B

Baffle Reflector Trim
OD: 7 1/2"



EL 755W

EL 755B
Wall Wash Reflector
with Baffle
OD: 7 1/2"



New Type IC Housing EL71C

A

Double adjustable bracket and socket plate made from light and strong aluminum

Height: 7 1/2"

Ceiling Opening: 6 1/2"

Lamp: 90W Max

B

Socket is protected (red cap) from paint over spray.

C

Locking screw for securing hanger bars after installation

D

"Lock Loop" for added strength. Break out line for 12" joist spacing.

E

Slots for T-bar installations
Self leveler lip

F

Inch marks for accurate height adjustments

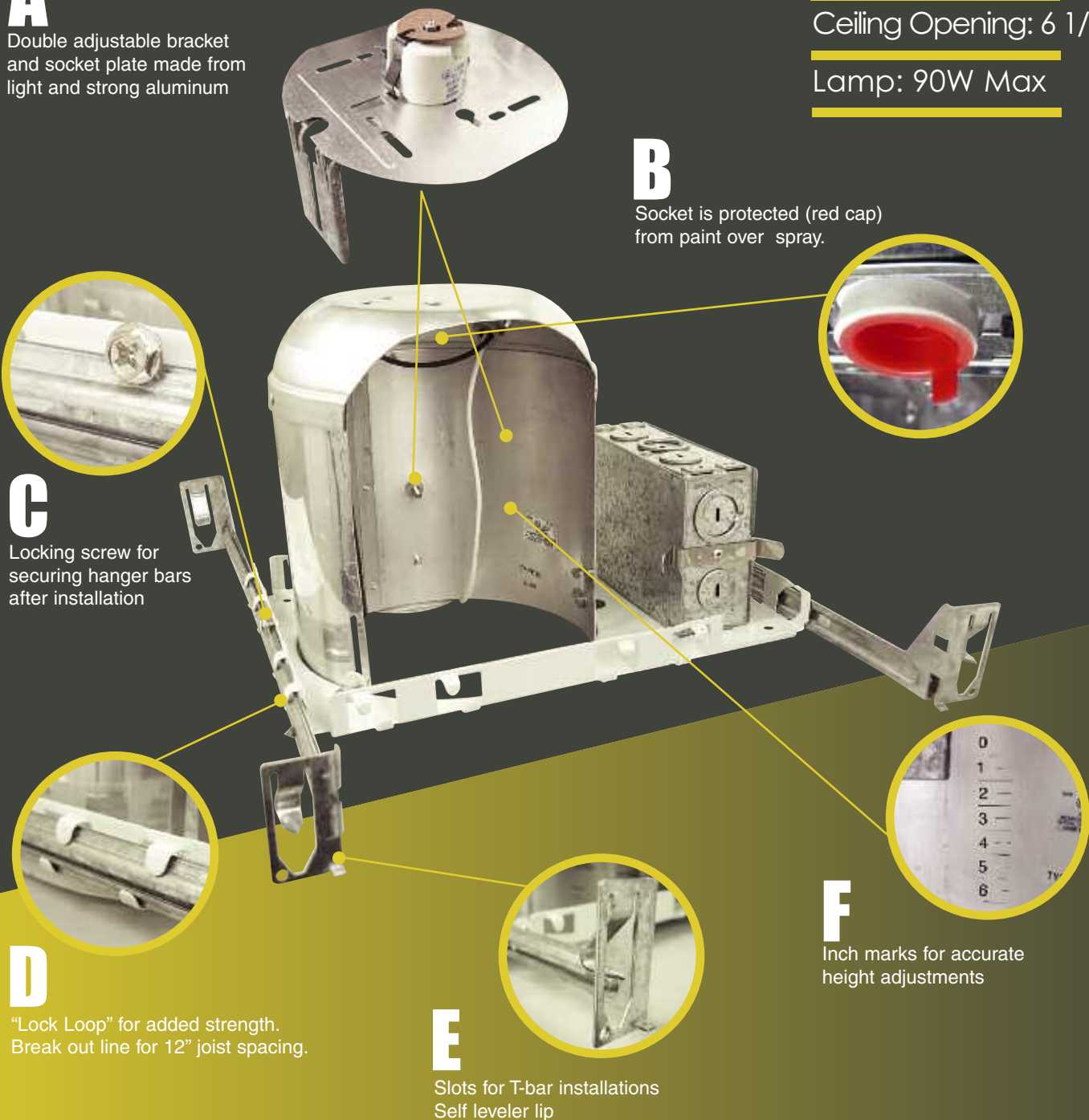

Features:

- All aluminum light weight housing.
- Integral thermal protector guards against improper lamping.
- Adjustable socket bracket.
- Feed through wiring box for use with 75° C supply wire.
- U.L. damp location listed.
- U.L. listed for direct contact with insulation.

EL530KW

5" Open Trim

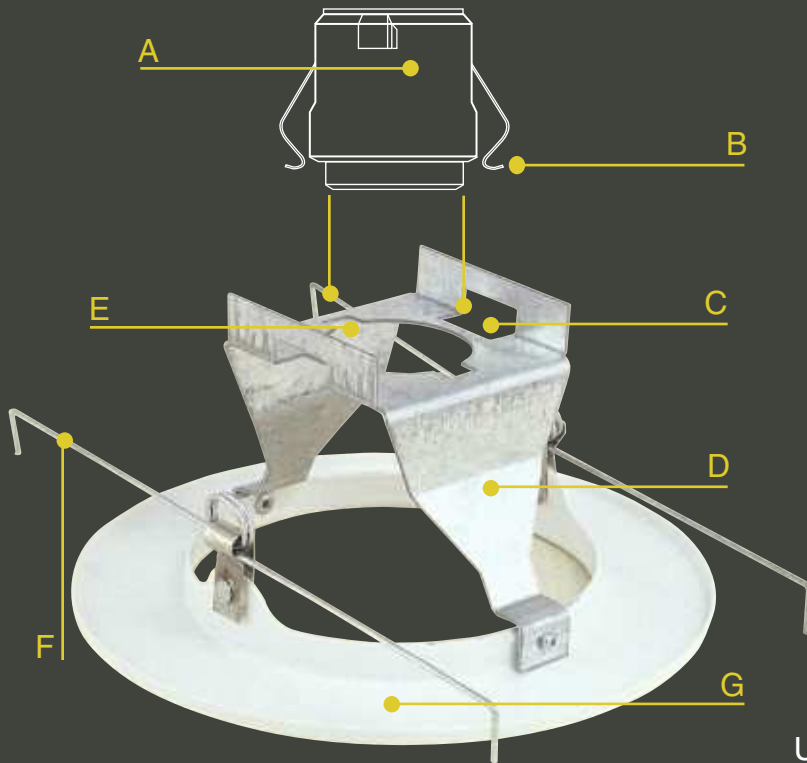

- A Medium base socket
- B Mounting Clips
- C Fits other manufacturers sockets
- D Socketholder Bracket
- E Fits Elco's sockets
- F Torsion Springs
- G Powder coated metal trim ring

U.S. Patent No. 6,364,511

Universal Socketholder Brackets For 5" Trims

ELP530KW

5" Phenolic Baffle Trim

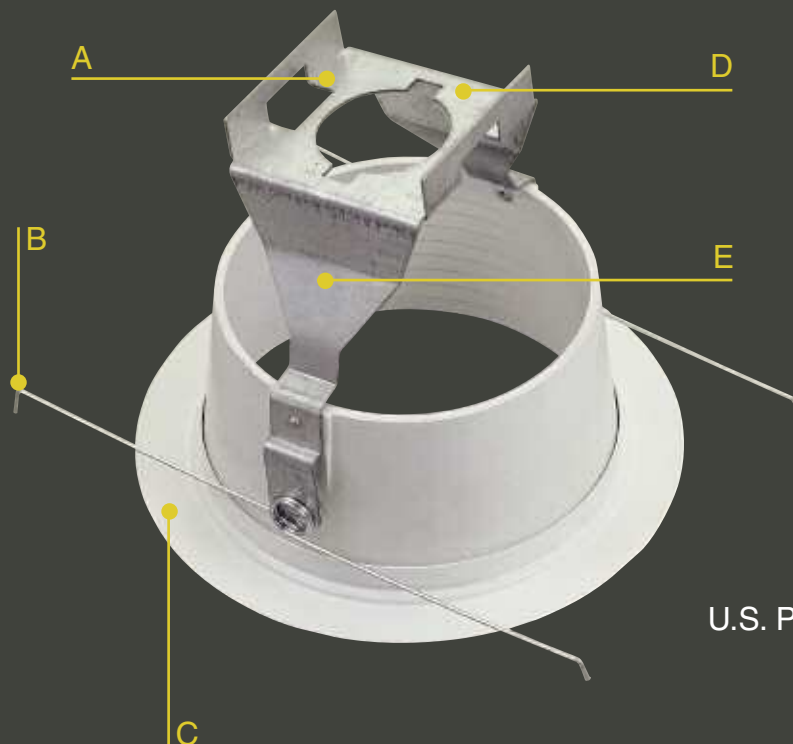

- A Fits other manufacturers sockets
- B Torsion Springs
- C Powder coated metal trim ring
- D Fits Elco's sockets
- E Socketholder Bracket

U.S. Patent No. 6,364,511

Line Voltage Trims

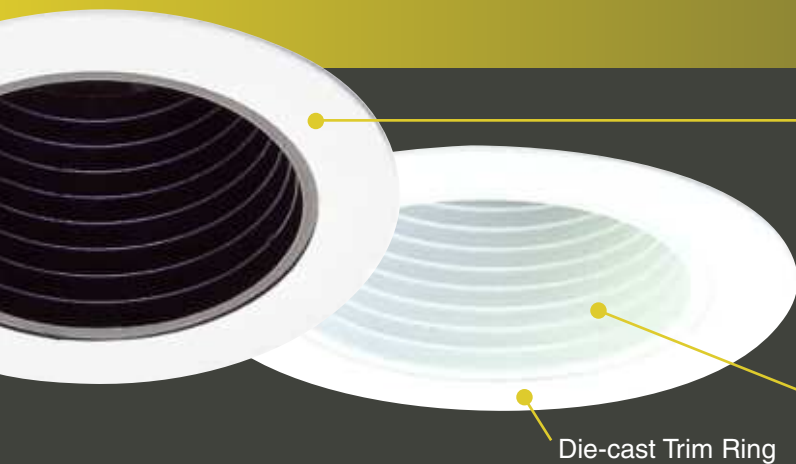

Baffle Trim with Die-cast Trim Ring

EL 994DW - This 4" Line Voltage Trim is less acceptable of corrosion and paint last longer than normal sheet metal trims.

Stepped Phenolic Baffle

Die-cast Trim Ring

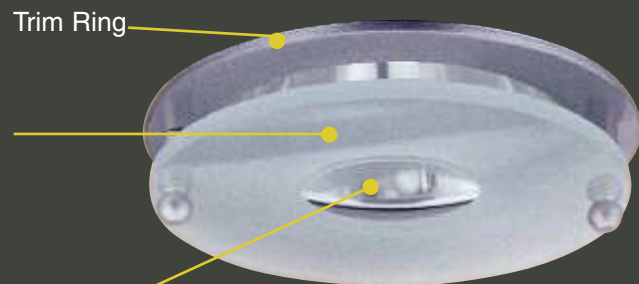

Glass Panel Trim with Reflector

EL 926C - Our new glass panel trim helps to diffuse light and give a softer effect for the ambience of your room.

Reflector

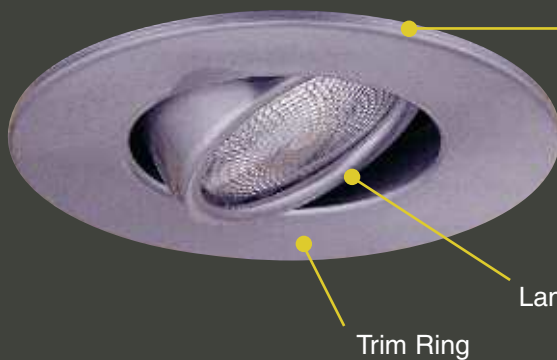

Brushed Nickel Finish Trims

EL 985N - This contemporary finish is perfect for the achitectural designs and trends of today.

Lamp Holder 30° adjustable

Trim Ring

Shower Trims

are great for where a trim is needed for wet locations.

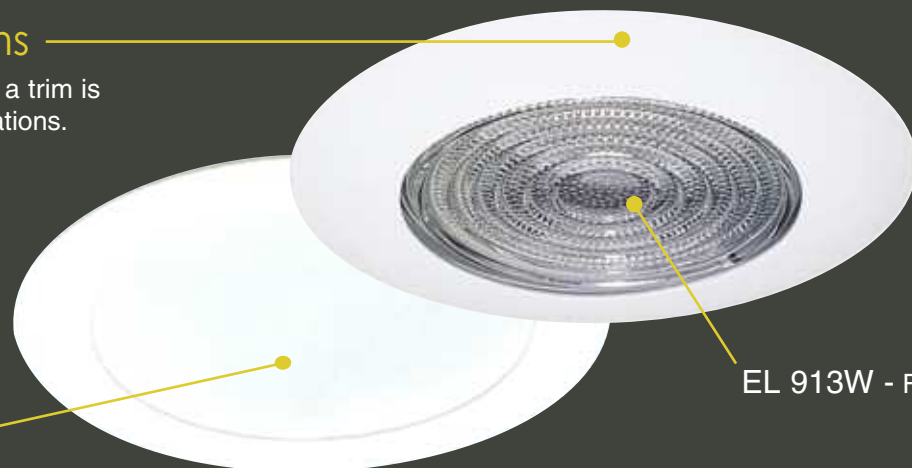

EL 913W - Fresnel Lens

EL 912W - Frosted Lens

4" White Cone Reflector Trim
EL 901W



Cone Trims



Pressure Clips

slides inside the housing gripping the inner walls for secure installations of the trim.

Cone Trims

produce much greater beam spread than normal trims due to the tapered angle of the reflector or baffle.

5" Cone Trims

ELM 500W - White Cone Baffle Trim
ELM 501W - White Cone Smooth Reflector Trim

6" Aluminum Airtight Cone Reflector Trim ELS 311C

Torsion Springs

attaches to a bracket mounted on the inner walls of the housing and holds and seats the trim firmly in place

Spun reflector with aluminum finish.

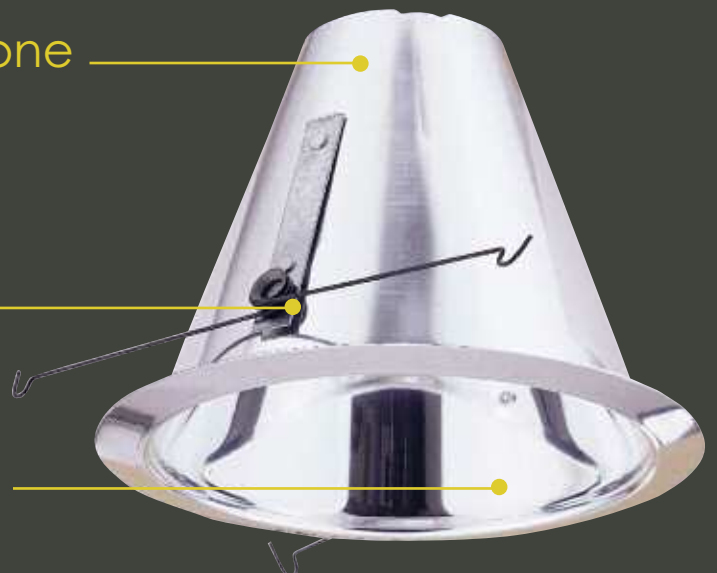

6" Universal IC Recessed Downlight

EL7IC

EL7ICA

EL7ICNB (no bracket)

EL7ICANB

6" Universal Housing

Height: 7 1/2" - Ceiling Opening: 6 1/2"

Lamp: 90W Max

- For installations where the housing will be in direct contact with ceiling insulation.
- Integral thermal protector provides positive protection against over lamping or improper lamping.
- Adjustable socket bracket allows the use of different lamp types and sizes as well as proper and consistent lamp positioning.
- Junction box is listed for through branch circuit wiring and has six 1/2" knockouts with true pry-out slots.

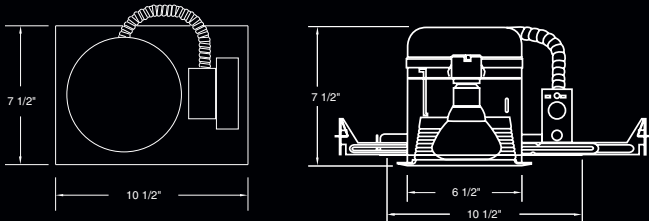

- Captive bar hangers span 24" joists and can be repositioned 90°
- 7 1/2" Height allows for use in 2 x 8 construction.
- Housing adjusts 1 3/8" to accommodate various ceiling thickness.
- U.L. Damp Location listed
- U.L. Feed through listed
- U.L. Listed for direct contact with insulation
- A= ASTM Airtight Fixture

EL7RICA

6" Remodel Housing Type IC

Height: 7 1/2" - Ceiling Opening: 6 1/2"

Lamp: 90W Max

- Integral thermal protector guards against improper lamping.
- Adjustable socket bracket.
- To cut exact size ceiling hole, use Elco EL5000 tool.
- Wiring box for use with 75°C supply wire.
- Unit slips through 6 1/2" ceiling cut out 6 3/8".

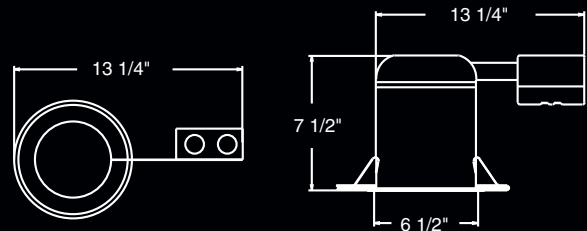

- Integral flange secures fixture against ceiling. Four remodel clips secure housing and accommodate various ceiling thickness. (up to 1 1/4")
- U.L. Damp Location Listed
- U.L. Listed for Direct contact with Insulation
- A= ASTM Airtight Fixture

EL7IC100A

Double Wall Housing Type IC

Height: 7 1/2" - Ceiling Opening: 6 1/2" - Lamp: 100W Max

- Housing is a thermally protected fixture that may be installed in direct contact with ceiling insulation.
- Integral thermal protector guards against improper lamping.
- Double wall aluminum housing.
- Junction box is listed for through branch circuit wiring and has (six) 1/2" knockouts with true pry-outs slots.
- Captive bar hangers span 24" joists and can be repositioned 90°.
- 7 1/2" height allows for use in 2 x 8 construction.
- Housing adjusts 3/4" to accommodate various ceiling thickness.
- U.L. listed for direct contact with insulation.
- A= ASTM Airtight Fixture

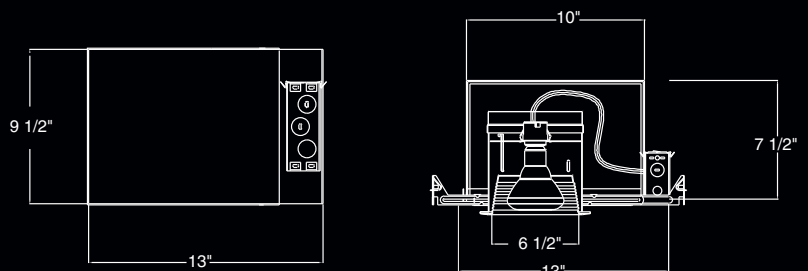

6" Universal Recessed Downlight (Cont.)

R10H

6" Universal Housing
 Height: 7 1/2" - Ceiling Opening: 6 1/2"
 Lamp: 150W Max

- Versatile, reliable and easy to install. The R10H is the best choice for residential and commercial applications.
- Integral thermal protector guards against misuse of insulation materials and improper lamping.
- Adjustable socket bracket allows the use of different lamp types and sizes as well as proper and consistent lamp positioning.
- Junction box is listed for through branch circuit wiring and has (six) 1/2" knockouts with true pry-out slots.

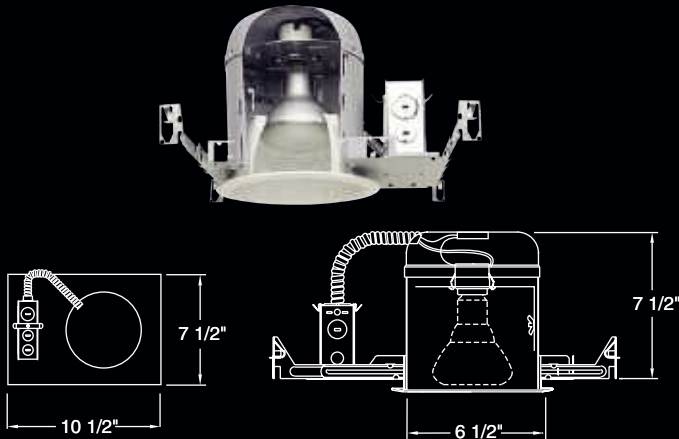

- Captive bar hangers span 24" joists and can be repositioned 90°.
- 7 1/2" height allows for use in 2 x 8 construction. Housing adjusts 1 3/8" to accommodate various ceiling thickness.
- U.L. Damp Location Listed
- U.L. Feed Through Listed

RR10H

6" Remodel Housing
 Height: 7 1/2" - Ceiling Opening: 6 1/2"
 Lamp: 150W Max

- Integral thermal protector guards against misuse of insulation materials and improper lamping.
- To cut exact size ceiling hole, use Elco EL5000 tool.
- Wiring box for use with 75°C supply wire.
- 7 1/2" height allows for use in 2 x 8 construction.

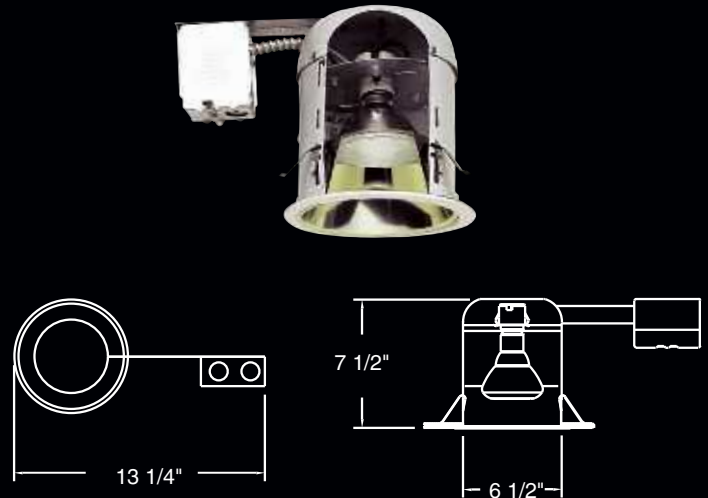

- Unit slips through 6 3/8" ceiling cut out. Integral flange secures fixture against ceiling. Four remodel clips secure housing and accommodate various ceiling thickness.
- Adjustable socket bracket
- U.L. Damp Location Listed
- U.L. Feed Through Listed

R9H

6" Shallow Housing
 Height: 5 1/2" - Ceiling Opening: 6 1/2"
 Lamp: 90W Max

- For use in shallow ceilings where 2 x 6 joist construction is used.
- Integral thermal protector guards against misuse of insulation material and improper lamping.
- Junction box is listed for through branch circuit wiring and has (six) 1/2" knockouts with true pry-out slots.
- Captive bar hangers span 24" joists and can be repositioned 90°.
- 5 1/2" height allows use in 2 x 6.
- Housing adjusts 1 3/8" to accommodate various ceiling thickness.
- Adjustable socket bracket
- U.L. Damp Location Listed
- U.L. Feed Through Listed

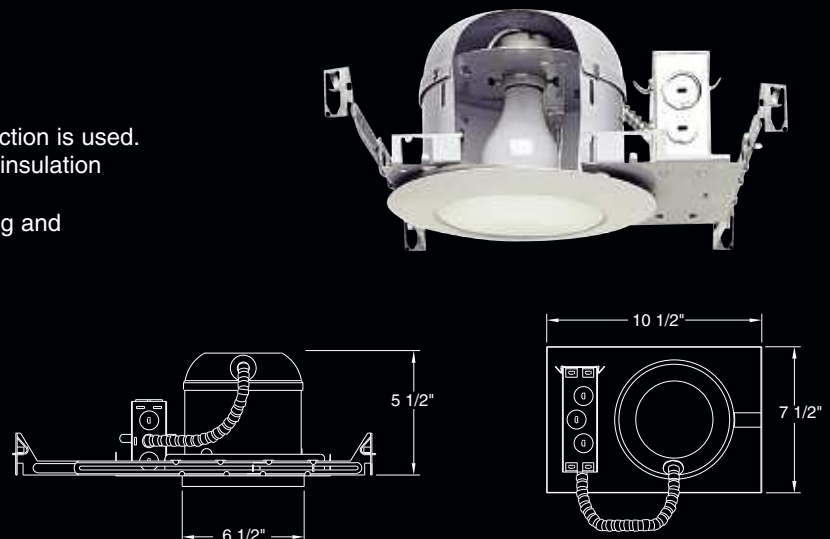

6" Universal Shallow Recessed Downlight

RR9H

6" Shallow Remodel Housing
 Height: 5 1/2" - Ceiling Opening: 6 1/2"
 Lamp: 90W Max

- For quick and easy installation in new or existing ceilings where 2 x 6 joist construction is used.
- Integral thermal protector guards against misuse of insulation material and improper lamping.
- Adjustable socket bracket allows the use of different lamp types and sizes as well as proper and consistent lamp positioning.
- To cut exact size ceiling hole, use Elco EL5000 tool.

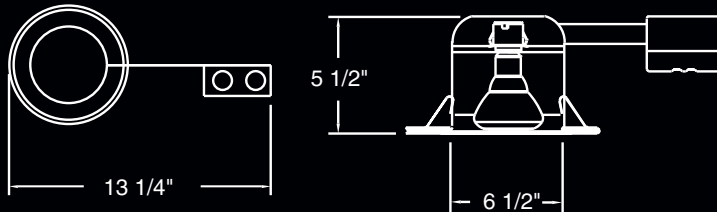

- Wiring box for use with 60°C supply wire.
- 5 1/2" height allows for use in 2 x 6 construction unit slips through 6 3/8" ceiling cut out.
- Integral flange secures fixture against ceiling.
- Four remodel clips secure housing and accommodate various ceiling thickness.

RR9ICA

6" Shallow Remodel Housing Type IC
 Height: 5 1/2" - Ceiling Opening: 6 1/2"
 Lamp: 75W Max

- Integral thermal protector guards against improper lamping.
- Adjustable socket bracket.
- To cut exact size ceiling hole, use Elco EL5000 tool.
- Wiring box for use with 75°C supply wire.
- Unit slips through 6 3/8" ceiling cut out.

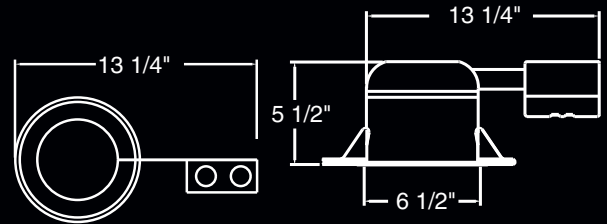

- U.L. listed
- A= ASTM Airtight Fixture

R9ICA

6" Shallow Housing (Type IC)
 Height: 5 1/2" - Ceiling Opening: 6 1/2"
 Lamp: 75W Max

- Thermally protected fixture that may be installed in direct contact with ceiling insulation.
- For use in shallow ceilings where 2" x 6" joist construction is used.
- Intergal thermal protector guards against improper lamping.
- Junction box is listed for through branch circuit wiring and has six 1/2" knockouts with true pry-outs slots.
- Captive bar hangers span 24" joists and can be repositioned 90°.
- Adjustable socket bracket
- U.L. listed
- A= ASTM Airtight Fixture

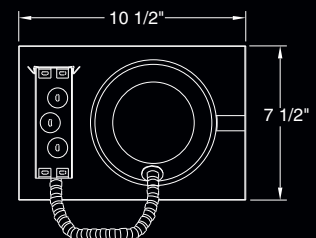
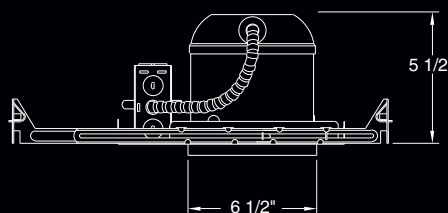

EL 30N
EL 30C
EL 30G
EL 30W

Open Trim
Lamp: PAR30-75W
R30-75W
O.D.: 8"



ELA 101BZ
Reflector
with Baffle
Lamp: 100W-A19
PAR30-75W
O.D.: 7 1/4"

NEW!



EL 40C
EL 40G
EL 40N
EL 40W

Open Trim
Lamp: PAR38-150W
R40-150W
O.D.: 7 1/4"



ELA 101CP
Reflector with Baffle
Lamp: 100W-A19
PAR30-75W
O.D.: 7 1/4"

NEW!



EL 304B
EL 304W
EL 304BG
EL304WG

Wide Flanged
Baffle Trim
Lamp: PAR30-75W
R30-75W
O.D.: 8"

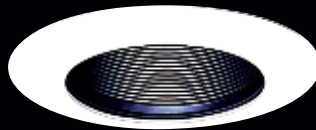

ELA 101NW
ELA 101NB
Reflector with Baffle
Lamp: PAR30-75W
13W-PL-Quad
100W-A19
O.D.: 7 1/4"



ELA 101B
Reflector with Baffle
Lamp: PAR30-75W
13W-PL-Quad
100W-A19
O.D.: 7 1/4"



ELA 101WA
Airtight Reflector
with Baffle
Lamp: PAR30-75W
13W-PL-Quad
100W-A19
O.D.: 7 1/4"



ELA 101N
ELA 101W
Airtight Reflector
with Baffle
Lamp: PAR30-75W
13W-PL-Quad
100W-A19
O.D.: 7 1/4"



ELA 102BZ
ELA 102B
ELA 102N
ELA 102W
Reflector with Baffle
Lamp: 100W-A19
PAR30-75W
O.D.: 7 1/4"

NEW!



6" Baffle Open Trims (Cont.)

ELA 102CP

Reflector with Baffle
Lamp: 100W-A19
PAR30-75W
O.D.: 7 1/4"

NEW!



ELM 30B

ELM 30N

ELM 30BB

ELM 30NB

ELM 30NW

Metal Baffle
Lamp: R30-75W
PAR30-75W
O.D.: 7 1/4"



ELM 30BOV

ELM 30WOV

Metal Baffle
Oversized Ring
Lamp: PAR30-75W
R30-75W
O.D.: 8"



ELM 30BG

Metal Baffle
Lamp: PAR30-75W
R30-75W
O.D.: 7 1/4"



ELM 30W

ELM 30WG

Metal Baffle
Lamp: R30-75W
PAR30-75W
O.D.: 7 1/4"



ELM 30BZ

ELM 30BBZ

ELM 30BCP

ELM 30BZB

ELM 30BZW

ELM 30WBZ

Bronze Metal Baffle
Lamp: PAR30-75W
R30-75W
O.D.: 7 1/4"

NEW!



ELM 30CP

ELM 30CPB

ELM 30CPW

ELM 30WCP

Copper Metal Baffle
Lamp: PAR30-75W
R30-75W
O.D.: 7 1/4"

NEW!



ELM 300W

ELM 300B

Self flanged
airtight Cone
Metal Baffle Trim
with torsion springs.
Lamp: PAR38-90W
BR40-120W, R30-PAR30
75W or 60W-A19
O.D.: 7 1/4"



ELM 302W

ELM 302B

Airtight Cone Metal
Baffle Trim with clips
and plastic trim ring.
Lamp: PAR38-90W
BR40-120W, R30-PAR30
75W or 60W-A19
O.D.: 7 1/4"



ELM 303W

One Piece Airtight
Trim, Self flanged
O.D.: 7 1/4"



ELM 305W

Shallow Airtight
Baffle, Self flanged
with Torsion Springs
Lamp: 75W R30 or PAR30
O.D.: 7 1/4"



ELM 40W

ELM 40N

ELM 40B

White Metal
Stepped Baffle
Lamp: PAR38-150
R40-150W
O.D.: 7 1/4"



6" Baffle Open Trims (Cont.)

ELM 40BZ **NEW!**
ELM 40BBZ
ELM 40BCP
 Bronze Metal Baffle
 Lamp: PAR38-150W
 R40-150W
 O.D.: 7 1/4"



ELP 30B
ELP 30BG
 Phenolic Baffle
 Lamp: PAR30-75W
 R30-75W
 O.D.: 7 1/4"



ELM 40CP **NEW!**
 Copper
 Metal Baffle
 Lamp: PAR38-150W
 R40-150W
 O.D.: 7 1/4"



ELP 30W
ELP 30WG
 Phenolic Baffle
 Lamp: PAR30-75W
 R30-75W
 O.D.: 7 1/4"



ELM 40BOV **NEW!**
ELM 40WOV
 Baffle with
 Oversized Ring
 Lamp: PAR38
 R40-150W
 O.D.: 8"



ELP 40W
ELP 40B
 Phenolic Baffle
 Lamp: R40-150W
 O.D.: 7 1/4"



6" Shower and Lensed Trims

EL 12W
EL 12G
EL 12N
EL 12SH (white Lexan ring)
EL 12KSH (white Lexan ring)
 Shower Trim
 Albalite Lens
 Lamp: 60W-A19
 O.D.: 8"



EL 13W
EL 13G
EL 13N
EL 13SH (white Lexan ring)
EL 13KSH (white Lexan ring)
 Fresnel Shower Trim
 Lamp: 60W-A19
 O.D.: 8"



EL 12BZ **NEW!**
 Shower Trim
 Albalite Lens
 Lamp: 40-60W A19
 O.D.: 8"



EL 13BZ **NEW!**
 Shower Trim
 Fresnel Lens
 Lamp: 60W- A19
 O.D.: 8"



EL 12CP **NEW!**
 Shower Trim
 Albalite Lens
 Lamp: 40-60W A19
 O.D.: 8"



EL 13CP **NEW!**
 Shower Trim
 Fresnel Lens
 Lamp: 60W -A19
 O.D.: 8"



6" Shower and Lensed Trims (Cont.)

EL 16W
 EL 16G
 EL 16SH (white Lexan ring)
 EL 16KSH (white Lexan ring)
 Drop Opal Shower Trim
 Lamp: 60W-A19
 O.D.: 8"



EL 16BZ
 Shower Trim with
 Drop Opal Lens
 Lamp: 40-60W-A19
 O.D.: 8"

NEW!



EL 16CP
 Shower Trim with
 Drop Opal Lens
 Lamp: 40-60W-A19
 O.D.: 8"

NEW!



EL 22W
 EL 22SH (white Lexan ring)
 Frosted Lensed Trim
 O.D.: 8"



EL 112W
 EL 112G
 EL 112SH (white Lexan ring)
 Shower Trim Lens
 with Reflector.
 O.D.: 8"



EL 112BZ
 Shower Trim Lens
 with Reflector.
 Lamp: 60W-A19
 O.D.: 8"

NEW!



EL 112CP
 Shower Trim Lens
 with Reflector.
 Lamp: 60W-A19
 O.D.: 8"

NEW!



EL 113W
 EL 113G
 EL 113SH (white Lexan
 ring)
 Shower Trim Lens with
 Reflector.
 O.D.: 8"



EL 113BZ
 Shower Trim Lens
 with Reflector.
 Lamp: 40W-A19
 O.D.: 8"

NEW!



EL 113CP
 Shower Trim Lens
 with Reflector.
 Lamp: 40W-19
 O.D.: 8"

NEW!



EL 114SH (white Lexan ring)
 Shower Trim with
 Diffused Dome Lens
 and Lexan Ring,
 with Reflector.
 O.D.: 8"



EL 116W
 EL 116G
 EL 116SH (white Lexan ring)
 IC Shower Light and
 IC Lensed Trim with
 Reflector in direct
 contact with insulation.
 O.D.: 8"



EL 116BZ
 Shower Trim with
 Reflector and
 Drop Opal Lens
 Lamp: 40W-A19
 O.D.: 8"

NEW!



EL 116CP
 Shower Trim with
 Reflector and
 Drop Opal Lens
 Lamp: 60W-A19
 O.D.: 8"

NEW!



EL 122W
 EL 122SH (white Lexan ring)
 Shower Trim
 with Reflector and
 Smooth Frosted Lens
 Lamp: 60W-A19
 O.D.: 8"



EL 312SH (white Lexan ring)
 Shower Trim with
 Albalite Lens and
 Reflector for Snap-In Socket.
 O.D.: 8"



6" Shower and Lensed Trims (Cont.)

EL 313SH (white Lexan ring)
Shower Trim with Fresnel
Lens and Reflector for
Snap-In Socket.
O.D.: 8"



ELM 42CP
Baffle with
Regressed
Albalite Lens
Lens with Baffle
Lamp: 60W-A19
O.D.: 7 1/4"

NEW!



EL 316SH (white Lexan ring)
Shower Trim Drop
Opal Lens Socket
Holder Reflector
O.D.: 8"



ELM 422W
Baffle with
Regressed
Frosted Lens
Lamp: 60W-A19
O.D.: 7 1/4"

NEW!



EL 319W **NEW!**
Shower Trim Drop
with white Acrylic Lens
Socket Holder
white Reflector
Lamp: 60W-A19
O.D.: 7 5/8"



ELM 43B
ELM 43W
Baffle with
Regressed
Fresnel Lens
Lamp: 60W-A19
O.D.: 7 1/4"



EL 376BZ **NEW!**
Adjustable Baffle
Trim with Gimbal
Lamp: 75W PAR30
O.D.: 7 1/4"



ELM 46B
ELM 46W
Baffle with
Regressed
Drop Opal Lens
Lamp: 60W-A19
O.D.: 7 1/4"



EL 376CP **NEW!**
Adjustable Baffle
Trim with Gimbal
Lamp: 75W PAR30
O.D.: 7 1/4"



ELM 47W **NEW!**
Baffle with
Regressed
Frosted Lens
Lamp: 60W-A19
O.D.: 7 1/4"

NEW!



ELM 42B
ELM 42W
ELM 42N
Baffle with
Regressed
Albalite Lens
Lamp: 60W-A19
O.D.: 7 1/4"



ELM 42BZ **NEW!**
Baffle with
Regressed
Albalite Lens
Lamp: 60W-A19
O.D.: 7 1/4"



ELS 42W
ELS 42C
ELS 42G
ELS 42B
Reflector with
Regressed
Albalite Lens
Lamp: 60W-A19
O.D.: 7 1/4"



6" Reflector Downlight Trims

ELA 95SC
ELA 95SB
ELA 95SG
ELA 95SW

Wall Wash
with Reflector
Lamp: 60W-A19
O.D.: 7 1/4"



ELA 99SB

Black Reflector
Lamp: 100W-A19
O.D.: 7 1/4"



ELA 99SC
ELA 99SG
ELA 99SW

Specular Cone
Reflector Trim
Lamp: 100W-A19
150W-A21
O.D.: 7 1/4"



NEW!

ELA 99SCBZ

Specular Cone Reflector
Trim, Bronze Ring
Lamp: 100W-A19
O.D.: 7 1/4"



NEW!

ELA 99SCCP

Specular Cone
Reflector Trim,
Copper Ring
Lamp: 100W-A19
O.D.: 7 1/4"



ELS 30B
ELS 30W

Specular Black
Reflector
Lamp: R30-75W
PAR30-150W-R40
O.D.: 7 1/4"



ELS 30C
ELS 30G

Specular Black
Reflector
Lamp: R30-75W
PAR30-150W-R40
O.D.: 7 1/4"



ELS 30GG
ELS 30CC

Specular Gold
Reflector with
Gold Ring
Lamp: R30-75W
PAR30-150W-R40
O.D.: 7 1/4"



ELS 30BZ

NEW!

Specular Bronze
Reflector
Lamp: PAR30-150W
R40-150
O.D.: 7 1/4"



ELS 30CP

NEW!

Specular Copper
Reflector
Lamp: PAR30-150W
R40-150
O.D.: 7 1/4"



ELS 40C
ELS 40G

Specular Reflector
Lamp: PAR38-150W
R40-150W
O.D.: 7 1/4"



ELS 310C

NEW!

Airtight Chrome
Reflector Cone Trim
with Torsion Springs.
Self Flanged.
Lamp: PAR38-90W
BR40 120W, R30-PAR30
75W or 60W-A19
O.D.: 7 1/4"



ELS 311C

Self flanged airtight
chrome Reflector Cone
Trim with torsion springs.
Lamp: PAR38-90W
BR40-120W, R30-PAR30
75W or 60W-A19
O.D.: 7 1/4"



EL 30W
EL 30C
EL 30G
EL 30N

Open Trim
Lamp: PAR30-R30 75W
O.D.: 7 1/4"



EL 79W

Pinhole Trim
Lamp: R20-PAR20
50W
O.D.: 7 1/4"



EL 30BZ

Open Trim
Lamp: PAR30-75W
R30-75W
O.D.: 8"

NEW!



EL 300W

Open Trim with
Lamp Holder Bracket.
Lamp: R30-75W
PAR30-75W
O.D.: 8"

NEW!



EL 30CP

Open Trim
Lamp: PAR30-75W
R30-75W
O.D.: 8"

NEW!



EL 308W

Open Splay
Lamp: PAR30
R30-75W
O.D.: 8"



EL 40N

Open Trim
Lamp: PAR38-150W
R40-150W
O.D.: 8"

NEW!



EL 408W

Open Splay
Lamp: PAR38-150W
R40-150W
O.D.: 8"



EL 40C

Open Trim
Lamp: PAR38-R40
150W
O.D.: 8"

EL 40G



EL 593W

3 3/8" Baffle
Lamp: PAR20-R20
50-75W
O.D.: 7 5/8"

EL 593B



EL 40BZ

Open Trim
Lamp: PAR38-150W
R40-150W
O.D.: 7 1/4"

NEW!



EL 599C

EL 599B

EL 599G

EL 599W

3 3/8" Reflector Trim
Lamp: PAR20-R20
50-75W
O.D.: 7 5/8"



EL 40CP

Open Trim
Lamp: PAR38-150W
R40-150W
O.D.: 7 1/4"

NEW!



ELM 301W

Self flanged airtight
smooth metal Cone Trim
with torsion springs
Lamp: PAR38-90W
BR40-120W, PAR30-R30
75W or 60W-A19
O.D.: 7 1/4"

NEW!



6" Adjustable Recessed Downlight Trims

EL 17B

Baffle Eyeball Trim
Lamp: PAR30-75W
R30-75W
O.D.: 8"



EL 18CP

Copper
Eyeball Trim
Lamp: PAR30-75W
R30-75W
O.D.: 8"

NEW!



EL 17W

Baffle Eyeball Trim
Lamp: PAR30-75W
R30-75W
O.D.: 8"



EL 77W

White Eyeball Trim
Lamp: PAR20-75W
R20-75W
O.D.: 8"



EL 18B

Eyeball Trim
Lamp: PAR30-75W
R30-75W
O.D.: 8"



EL 317W

Adjustable
Gimbal Ring
Lamp: PAR30-75W
O.D.: 8"



EL 18N

Brushed
Nickel Eyeball
Lamp: PAR30-75W
R30-75W
O.D.: 8"



EL 317CP

Adjustable
Gimbal Ring
Lamp: PAR30-75W
O.D.: 8"

NEW!



EL 18W

White Eyeball
Lamp: PAR30-75W
R30-75W
O.D.: 8"



EL 317BZ

Adjustable
Gimbal Ring
Lamp: PAR30-75W
O.D.: 8"

NEW!



EL 18BZ

Bronze Eyeball Trim
Lamp: PAR30-75W
R30-75W
O.D.: 8"

NEW!



EL 318W

Adjustable
Gimbal Ring
Lamp: PAR38-150-90W
O.D.: 7 1/4"



6" Adjustable Recessed Downlight Trims (Cont.)

EL 376B
EL 376N
EL 376W
 Reflector with
 Regressed Gimbal
 Lamp: PAR30 50-75W
 O.D.: 7 1/4"



EL 478W
EL 478B
 Adjustable Reflector
 Lamp: PAR38-150W
 O.D.: 7 1/4"



EL 377W
EL 377B
EL 377C
EL 377G
 Reflector with
 Regressed Gimbal
 Lamp: PAR30 50-75W
 O.D.: 7 1/4"



EL 508B
EL 508W
 Adjustable Spot
 Lamp: MR16-120V
 JDR 60W
 O.D.: 7 1/4"



EL 419BB
EL 419BW
EL 419CG
EL 419CN
EL 419CW
EL 419GG
EL 419GW
EL 419WW
 Reflector Finish with
 Eyeball Finish
 Lamp: PAR30-R30-75W
 O.D.: 7 1/4"



1st letter is reflector finish
 2nd letter is eyeball finish
 Standard trim ring is white.

EL 510B
EL 510N
 Adjustable Spot
 (PSA28 OR PSA29)
 Lamp: MR16-120V
 JDR 60W
 O.D.: 7 1/4"



EL 476W
EL 476B
 Adjustable Baffle
 Trim with Gimbal
 Lamp: PAR38-150W
 O.D.: 7 1/4"



EL 510W
 Adjustable Spot
 (PSA28 OR PSA29)
 Lamp: MR16-120V
 JDR 60W
 O.D.: 7 1/4"



EL 477C
EL 477B
EL 477G
EL 477W
 Adjustable Reflector
 Lamp: PAR38-150W
 O.D.: 7 1/4"



EL 588B
EL 588W
 Adjustable Spot
 (PSA28 OR PSA29)
 Lamp: MR16-120V
 JDR 60W
 O.D.: 7 1/4"



6" Adjustable Recessed Downlight Trims (Cont.)

ELM 38B
ELM 38N
ELM 38W
ELM 38BG
ELM 38BGG

Regressed Eyeball
Baffle Trim
Includes PSE26 Socket
Lamp: PAR30-75W
R30-75W
O.D.: 7 1/4"



ELM 48N
ELM 48NW
Regressed Eyeball
with Baffle Trim
Lamp: R30-75W
O.D.: 7 1/4"



ELM 48W
ELM 48WG
ELM 48WGG

Regressed Eyeball
with Baffle Trim
Lamp: R30-75W
O.D.: 7 1/4"



ELM 38BZ **NEW!**
Regressed Eyeball
Includes PSE26
Socket Extender
Lamp: PAR30-75W
R30-75W
O.D.: 8"



ELM 38CP **NEW!**
Regressed Eyeball
Includes PSE26 Socket
Lamp: PAR30-75W
R30-75W
O.D.: 7 1/4"



ELM 48CP **NEW!**
Regressed Eyeball
with Baffle Trim
Lamp: PAR30-75W
R30-75W
O.D.: 7 1/4"



ELM 48B
ELM 48BB
ELM 48BG
ELM 48BGG
Regressed Eyeball
with Baffle Trim
Lamp: R30-75W
O.D.: 7 1/4"



ELM 48BZ **NEW!**
Regressed Eyeball
with Baffle Trim
Lamp: PAR30-75W
R30-75W
O.D.: 7 1/4"



6" Wall Wash Trims

EL 25W
Wall Wash
Lamp: 60W-A19
O.D.: 8"



ELM 45B
ELM 45W
Scoop Trim with
Wall Wash
Lamp: 60W-A19
O.D.: 7 1/4"



ELA 105B
ELA 105W
Wall Wash Baffle
with Reflector
Lamp: 60W-A19
O.D.: 7 1/4"



Line Voltage Sloped Ceiling

Recessed Downlight Specifically Designed for Sloped Ceilings

Contemporary architecture has builders rushing to incorporate vaulted and cathedral ceilings as a new trend in home building increases in popularity. The most popular style emerging in sloped ceiling lighting is the use of recessed lighting fixtures with baffled downlights. Incorporating these sloped ceiling designs for recessed lighting has not been easy until now. ELCO's new sloped ceiling downlights meet current demands and are designed specifically for sloped ceilings. The baffle and reflector adjust to the pitch of the ceiling and are fully adjustable from 0° to 45° angles to accommodate vaulted or cathedral ceilings.

ELCO's products for sloped ceilings are available in line voltage, low voltage and fluorescent sloped housings and install as easy as ordinary standard recessed fixtures.

ELCO Sloped Line Voltage provides an innovative solution for most sloped ceiling installations. Since the ELCO Sloped Fixture can be used in ceilings ranging from 2/12 (10°) to 12/12 (45°) slopes, there is no need for separate housings or separate trims.

Sloped Conversion Chart

Sloped	2/12	3/12	4/12	5/12	6/12	7/12	8/12	9/12	10/12	11/12	12/12
Degrees	10°	14°	18.5°	22.5°	26.5°	30°	33.5°	36.8°	39.8°	42.5°	45°

U.S. Patent No. 5548499



Angle Cut Baffle

The baffle cylinder is molded on an angle. The baffle grooves remain parallel to the floor providing proper optics and cosmetics.



Elliptical Trim Ring

Die-formed trim ring precisely fits the slanted baffles elliptical aperture for a clean appearance and perfect function.



Lamp Adjustment

allows vertical lamp aiming on ceiling slopes from 2/12 to 12/12.



Baffle Trim Grooves

will always remain parallel to the floor.

Elco's Adjustable Socket Bracket

One of the important features on our sloped ceiling trim, the EL622KW, is the adjustable socket aiming mechanism, which swivels and rotates to align the lamp plumb with the floor or at an angle on the wall. The socket bracket provides quick and consistent lamp settings and is suitable for feed thru and listed for damp locations.

EL900HT

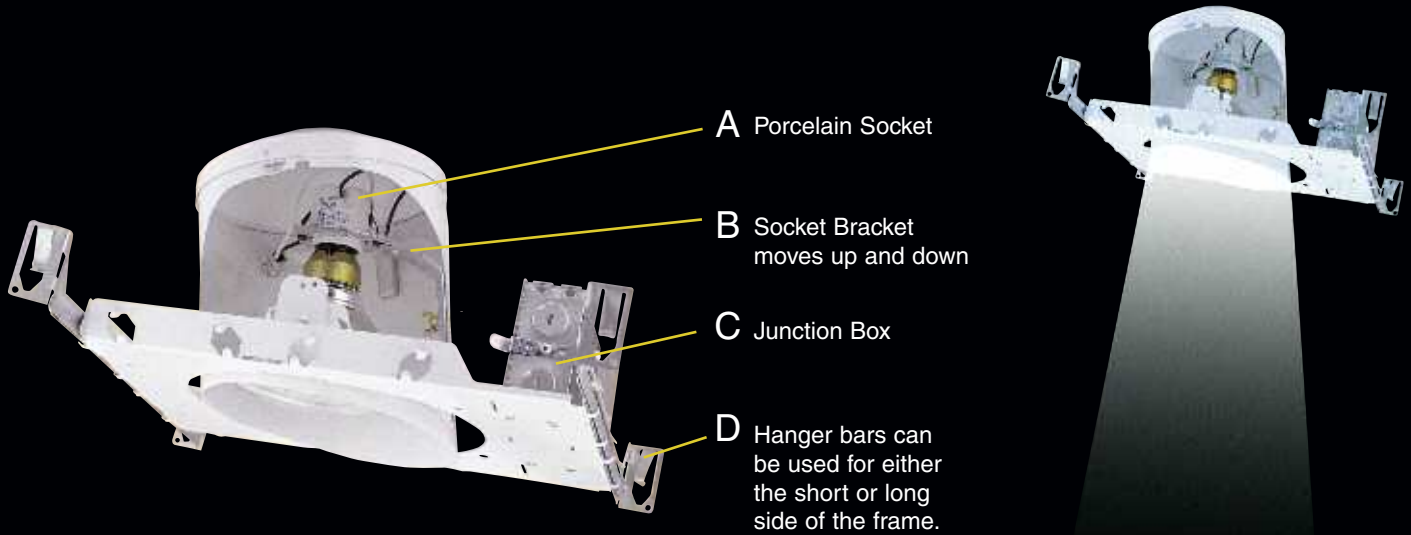

EL622KW (Adjustable)

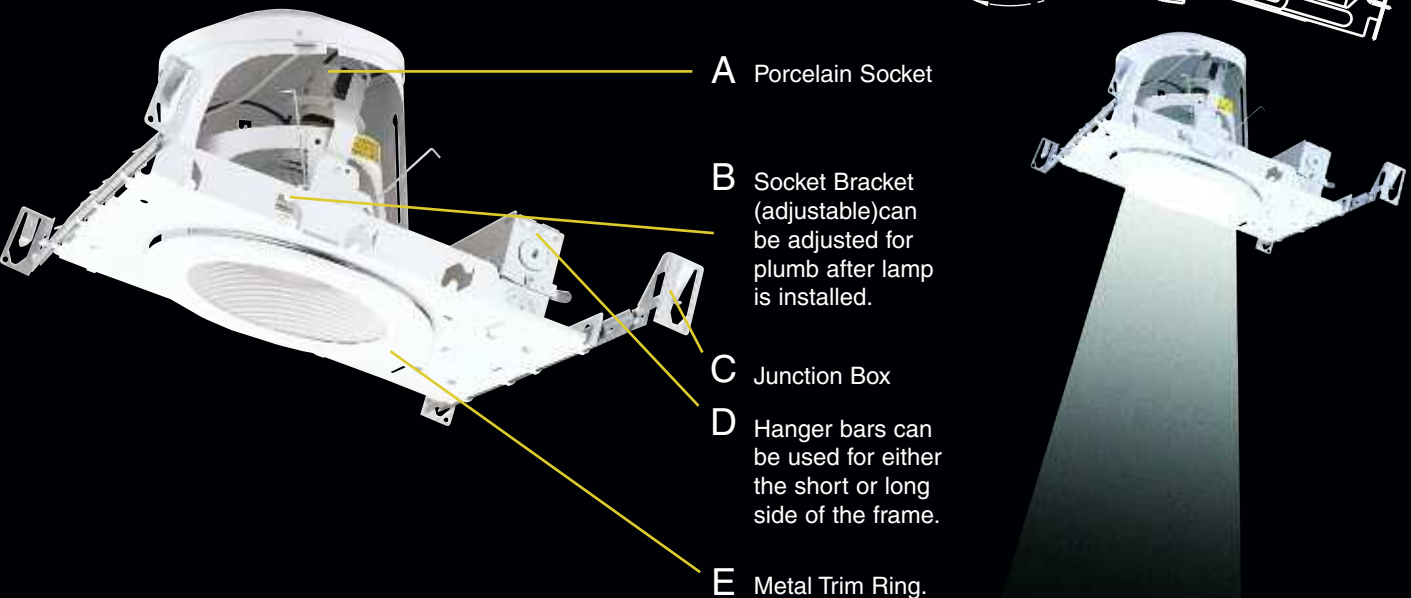

Sloped Ceiling Downlight 2/12 to 12/12 Line Voltage Type

EL900HT

6" Sloped Housing Type Non IC
Height: 7 1/2" - Opening: 6 1/2" x 6 3/4"

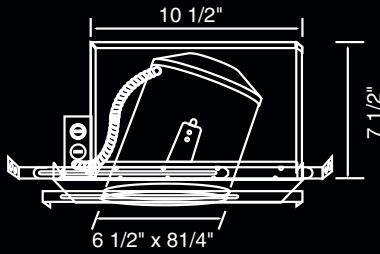

EL900RT

6" Sloped Remodel Type Non IC
Height: 7 1/2" - Opening: 6 1/2" x 6 3/4"

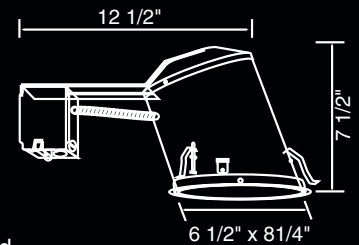

Features for EL900HT and EL900RT

- Junction box is listed for through branch circuit wiring and has (five) 1/4" knockouts with true pryout slots.
- Designed for use in ceilings with slopes from 1/12 to 12/12.
- Integral thermal protector guards against improper lamping.
- Elliptical Aperture and Trim Ring match ceiling slope.
- Slide bar hangers span 24" joists.
- U.L. Damp Location Listed
- U.L. Feed Through Listed

Economy IC Sloped Ceiling Downlight

EL918ICA

6" Slope Housing Type IC (Single Wall)
Opening: 6 1/2" x 6 3/4" - Height: 7 1/2"
Lamp: 75W

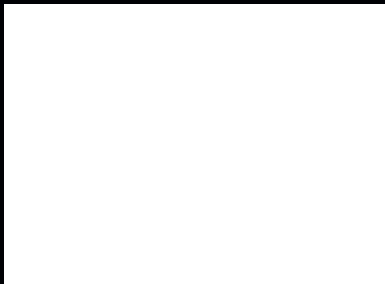

Features for EL918ICA and EL918RICA

- Junction box is listed for through branch circuit wiring and has (five) 1/4" knockouts with true pryout slots.
- Integral thermal protector guards against improper lamping.
- Elliptical Aperture and Trim Ring match ceiling slope.
- Single wall aluminum construction.
- Interlocking bar hangers span 24" joists
- U.L. Damp Location Listed
- U.L. Feed Through Listed
- U.L. listed for direct contact with insulation
- A= ASTM Listed Airtight Fixture

EL918RICA

6" Slope Remodel Housing
Type IC (Single Wall) Lamp: 75W

NEW!

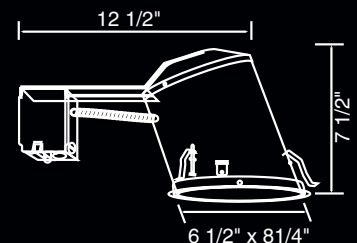

Super IC Sloped Ceiling Downlight

EL936ICA

Adjustable Airtight
6" Sloped Housing Type IC
(Double Wall) - Lamp: 90W

Features for EL936ICA

- Designed for use in ceilings with slopes from 2/12 to 12/12 where the fixture will come in direct contact with insulation. Adjustable trims maintain proper lamp aiming.
- Integral thermal protector guards against improper lamping.
- Junction box is listed for through branch circuit wiring and has (six) 1/2" knockouts with true pry-out slots.
- Double wall aluminum construction.
- Interlocking bar hanger span 24" joists.
- Elliptical aperture and trim ring match ceiling slope.
- U.L. Damp Location Listed
- U.L. Feed Through Listed
- U.L. listed for direct contact with insulation.
- A= ASTM Listed Airtight Fixture

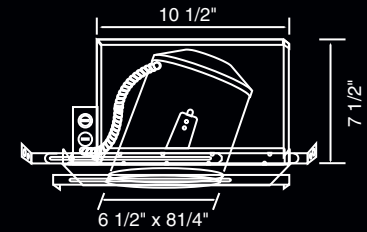

6" Line Voltage Sloped Ceiling Trims

EL 12W

EL 12SH (white Lexan ring)
Albalite Shower Trim
Lamp: 60W-A19
O.D.: 8"



EL 601W

EL 601B
Adjustable Sloped Baffle
with Reflector Trim
Angle: 30° Adjustment
Lamp: PAR30-75W
O.D.: 7 5/8" x 7 7/8"



EL 12CP

Albalite Shower Trim
Lamp: 60W-A19
O.D.: 8"

NEW!



EL 610W

EL 610B
Adjustable Spot
with Baffle Trim
Angle: 30° Adjustment
Lamp: MR16-120V
with PSA28 or PSA29
JDR 75W
O.D.: 8"



EL 13W

EL 13SH (white Lexan ring)
Fresnel Shower Trim
Lamp: 60W-A19
O.D.: 8"



EL 611W

EL 611B
EL 611C
EL 611G
Adjustable Sloped
Spot with Reflector Trim
Angle: 30° Adjustment
Lamp: MR16-120V
with PSA28 or PSA29
JDR 75W
O.D.: 8"



EL 13CP

Fresnel Shower Trim
Lamp: 60W-A19
O.D.: 8"

NEW!

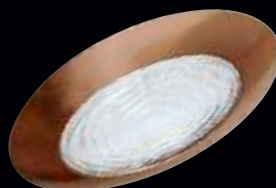

6" Line Voltage Sloped Ceiling Trims (Cont.)

EL 616W
EL 616B
EL 616C
EL 616G

with adjustable bracket
 Sloped Adjustable Trim
 Lamp: PAR38_150W
 PAR30-75W
 O.D.: 7 3/8" x 7 5/8"



EL 622KW
EL 622KB
EL 622KBG

Sloped Phenolic
 Baffle with Adjustable
 Lamp Holder
 Lamp: PAR38-150W or
 PAR30-75W
 O.D.: 7 5/8" x 7 7/8"



EL 616KC
EL 616KG

with adjustable bracket
 Sloped Adjustable
 Trim with Adjustable
 Bracket
 Lamp: PAR38_150W
 PAR30-75W
 O.D.: 7 3/8" x 7 5/8"



EL 623W

Sloped White
 Phenolic Baffle
 and Plastic Ring
 Lamp: PAR30-75W
 O.D.: 7 5/8" x 7 7/8"



EL 618W
EL 618B

Regressed
 Eyeball Baffle
 Lamp: PAR30 R30-75W
 O.D.: 8"



EL 624B
EL 624W

Sloped Phenolic
 Baffle with Gimbal Ring
 Lamp: PAR30-75W
 O.D.: 7 5/8" x 7 7/8"



EL 619CW
EL 619WW

Regressed
 Eyeball Reflector
 Lamp: PAR30 R30-75W
 O.D.: 8"



EL 626B

Sloped Black Phenolic
 Baffle with Gimbal Ring
 Lamp: PAR38-150W
 O.D.: 7 1/16" x 7 3/8"



EL 622W
EL 622B
EL 622BG

Sloped Phenolic Baffle
 Lamp: PAR38-150W or
 PAR30-75W
 O.D.: 7 5/8" x 7 7/8"



EL 626W

Sloped White Phenolic
 Baffle with Gimbal Ring
 Lamp: PAR38-150W
 O.D.: 7 1/16" x 7 3/8"



EL 642G
EL 642B
EL 642C
EL 642W

Reflector with Lens Trim
 Lamp: 60W-A19
 O.D.: 8"



8" Incandescent Square Housing and Trim

EL8SQ

- Shallow Housing 5 3/8"
- 90W Max lamp rating.
- Integral Thermal Protector to Protect against over lamping or improper lamping
- Junction box is listed for through branch circuit wiring with 1/2" and 3/4" pryouts knockouts.
- Captive bar hangers span 24" Joist and can be repositioned 90°
- U.L. listed for damp locations
- U.L. feed through listed



EL 10W

Square Trims with Prismatic Glass Lens
O.D.: 9 3/8 square

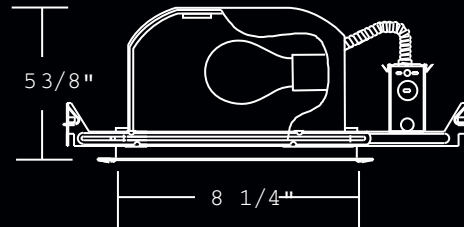

EL 11W

Square Trims with Fresnel Lens
O.D.: 9 3/8 square



EL 15W

Square Louvered Trim
O.D.: 9 3/8 square"



5" Universal Recessed Downlight

EL5ICA

Adjustable Airtight
5" Universal Housing
Height: 7 1/2" - Ceiling Opening: 5 1/2"
Lamp: 75W

- For installations where the housing will be in direct contact with ceiling insulation.
- Integral thermal protector provides positive protection against over lamping or improper lamping.
- Adjustable socket bracket allows the use of different lamp types and sizes as well as proper and consistent lamp positioning.
- Junction box is listed for through branc circuit wiring and has six 1/2" knockouts with true pry-out slots.



- Captive bar hangers span 24" joists and can be repositioned 90°.
- Housing adjusts 1 3/8" to accommodate various ceiling thickness.
- U.L. Damp Location Listed
- U.L. Feed Through Listed
- U.L. Listed for direct contact with insulation
- A= ASTM Airtight

EL5RICA

Adjustable Airtight
5" Remodel Housing IC
Height: 7 1/2" - Ceiling Opening: 5 1/2"
Lamp: 75W

- Integral thermal protector guards against improper lamping.
- To cut exact size ceiling hole, use Elco EL5000 tool.
- Unit slips through 5 1/2" ceiling opening. Integral flange secures fixture against ceiling. Four remodel clips secure housing and accommodate various ceiling thickness.

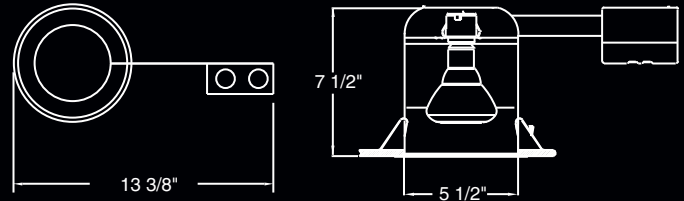

- Wiring box for use with 75°C supply wire.
- Adjustable socket bracket.
- U.L. Damp Location Listed
- A= ASTM Airtight

R5H

Adjustable Airtight
5" Universal Housing
Height: 7 1/2" - Ceiling Opening: 5 1/2" - Lamp: 75W

- Versatile, reliable and easy to install. The R5H is the best choice for residential and commercial applications.
- Integral thermal protector guards against misuse of insulation materials and improper lamping.
- Adjustable socket bracket allows the use of different lamp types and sizes as well as proper and consistent lamp positioning.
- Pre-wired junction box provided with 1/2" and 3/4" knockouts. UL/CUL listed for through branch wiring, maximum (8) No. 12 AWG branch circuit conductors (4 in, 4 out). Junction box equipped with 4 ROMEX Knockouts with internal strain relief clips for easy installation, where code allows. Junction box provided with removable access plates.
- Captive bar hangers span 24" joists and can be repositioned 90°.

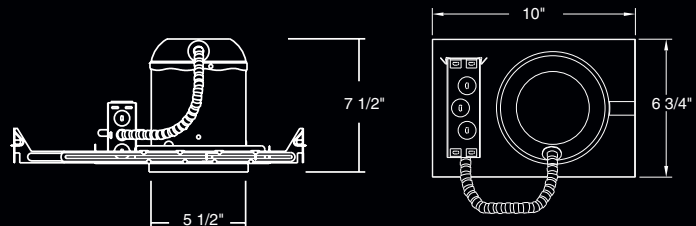

- 7 1/2" height allows for use in 2 x 8 construction. Housing adjusts 1 3/8" to accommodate various ceiling thicknesses.
- UL Damp Location Listed

5" Universal Recessed Downlight (Cont.)

EL55ICA

Adjustable Airtight
 5" Shallow Housing
 Height: 5 1/2" - Ceiling Opening: 5 1/2"
 Lamp: 75W

- For installations where the housing will be in direct contact with ceiling insulation.
- Integral thermal protector provides positive protection against over lamping or improper lamping.
- Adjustable socket bracket allows the use of different lamp types and sizes as well as proper and consistent lamp positioning.
- Junction box is listed for through branch circuit wiring and has six 1/2" knockouts with true pry-out slots.



EL55RICA

Adjustable Airtight
 5" Shallow Remodel Housing
 Height: 5 1/2" - Ceiling Opening: 5 1/2"
 Lamp: 75W

- For installations where the housing will be in direct contact with ceiling insulation.
- Integral thermal protector provides positive protection against over lamping or improper lamping.
- Adjustable socket bracket allows the use of different lamp types and sizes as well as proper and consistent lamp positioning.
- Junction box is listed for through branch circuit wiring and has six 1/2" knockouts with true pry-out slots.

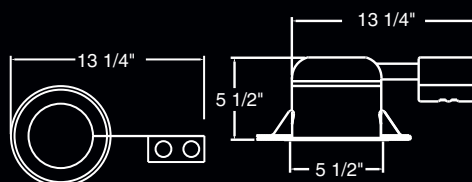

- Captive bar hangers span 24" joists and can be repositioned 90°.
- 5 1/2" height allows for use in 2 x 6 construction.
- Housing adjusts 1 3/8" to accommodate various ceiling thickness.
- U.L. Damp Location Listed
- U.L. Feed Through Listed
- U.L. Listed for direct contact with insulation
- A= ASTM Airtight

- 5 1/2" height allows for use in 2 x 6 construction.
- U.L. Damp Location Listed
- U.L. Feed Through Listed
- U.L. Listed for direct contact with insulation
- A= ASTM Airtight

RR5H

5" Remodel Housing
 Height: 7 1/2" - Ceiling Opening: 5 1/2"
 Lamp: 75W

- Integral thermal protector guards against misuse of insulation materials and improper lamping.
- To cut exact size ceiling hole, use Elco EL5000 tool.
- Wiring box for use with 75°C supply wire.
- 7 1/2" height allows for use in 2 x 8 construction.
- Unit slips through 5 1/2" ceiling opening. Integral flange secures fixture against ceiling. Four remodel clips secure housing and accommodate various ceiling thicknesses.
- Adjustable socket bracket.
- UL Damp Location Listed

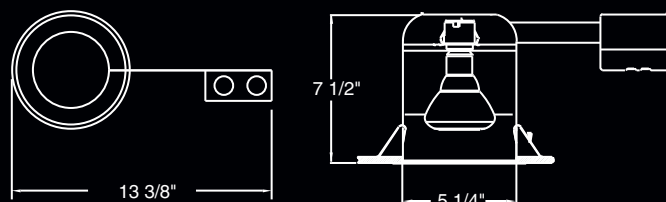

5" Open Trims

EL 530W

Open Trim
Lamp: PAR30-75W
R30-75W
O.D.: 6 1/4"



EL 530KW

Open Trim with
Lamp Holder Bracket
Lamp: PAR30-75W
R30-75W
O.D.: 6 1/4"



5" Baffle Trims

EL 511W

EL 511B

Metal Splay Baffle Trim
Lamp: PAR30-75W
R30-75W
O.D.: 6 1/4"



ELM 5045B

ELM 5045W

Wall Wash Baffle with
Socket Bracket
Lamp: PAR30-75W
R30-75W
O.D.: 6 1/4"

NEW!



ELA 501W

ELA 501B

Reflector with
Baffle Trim
Lamp: PAR30-75W
R30-75W or 60W-A19
O.D.: 6 1/4"



ELM 530W

ELM 530B

ELM 530N

Metal Stepped Baffle
with black finish
Lamp: PAR30-75W
R30-75W
O.D.: 6 1/4"



ELM 500WW

ELM 500W

ELM 500B

Airtight Metal
Cone Baffle
Lamp: PAR30-75W
R30-75W or 60W-A19
O.D.: 6 1/4"



ELM 530BG

Black Metal Baffle
with Gold Ring
Lamp: PAR30-75W
R30-75W
O.D.: 6 1/4"



ELM 5033B

ELM 5033N

ELM 5033W

Baffle Trim with
Socket Bracket
Lamp: PAR30-75W
R30-75W
O.D.: 6 1/4"



ELM 530BZW

ELM 530BZB

ELM 530BZ

Bronze Metal
Stepped Baffle
Lamp: PAR30-75W
R30-75W
O.D.: 6 1/4"

NEW!



ELM 5033CP

Baffle Trim with
Socket Bracket
Lamp: PAR30-75W
R30-75W
O.D.: 6 1/4"

NEW!



ELM 530CP

ELM 530CPB

ELM 530CPW

Copper Metal
Stepped Baffle
Lamp: PAR30-75W
R30-75W
O.D.: 6 1/4"

NEW!



5" Baffle Trims (Cont.)

ELM 530BOV
ELM 530WOV
 Metal Baffle with
 Oversized Ring
 Lamp: PAR30-75W
 R30-75W
 O.D.: 7 1/4"



ELP 530B
ELP 530BG
ELP 530BN
 Phenolic Baffle
 Lamp: PAR30-75W
 R30-75W
 O.D.: 6 1/4"



ELM 530NW
ELM 530NB
 Brushed Nickel
 Metal Stepped Baffle
 Lamp: PAR30-75W
 R30-75W
 O.D.: 6 1/4"



ELP 530W
ELP 530WN
 Phenolic Baffle
 Lamp: R30-75W
 PAR30-75W
 O.D.: 6 1/4"



ELM 530KB
ELM 530KN
ELM 530KW
 Metal Stepped
 Baffle with Lamp
 Holder Bracket
 Lamp: PAR30-75W
 R30-75W
 O.D.: 6 1/4"



ELP 530WCP **NEW!**
 Stepped Baffle
 with Copper Ring
 Lamp: PAR30-75
 R30-75
 O.D.: 6 1/4"



ELM 530KBZ **NEW!**
 Metal Stepped
 Baffle with Lamp
 Holder Bracket
 Lamp: PAR30-75W
 R30-75W
 O.D.: 6 1/4"



ELP 530KB
ELP 530KW
ELP 530KBN
ELP 530KWN
 Phenolic Baffle
 with Universal
 Lampholder Bracket
 LAMP: PAR30-75W
 R30-75W
 O.D.: 6 1/4"



ELM 530KCP **NEW!**
 Metal Stepped
 Baffle with Lamp
 Holder Bracket
 Lamp: PAR30-75W
 R30-75W
 O.D.: 6 1/4"



ELP 530KBBZ **NEW!**
 Phenolic Baffle
 Trim with Lamp
 Holders Bracket
 and torsion springs
 Lamp: PAR30-75
 R30-75
 O.D.: 6 1/4"



ELM 530KBCP **NEW!**
 Metal Stepped
 Baffle with Lamp Holder
 Bracket
 Lamp: PAR30-75W
 R30-75W
 O.D.: 6 1/4"



ELP 530KBCP **NEW!**
 Black Stepped
 Baffle with Copper
 Ring with Bracket
 Lamp: PAR30-75
 R30-75
 O.D.: 6 1/4"





5" Reflector Downlight Trims

ELA 599SB

Black Reflector
Lamp: 60W-A19
O.D.: 6 1/4"



ELA 599SC

Specular Reflector
Lamp: 60W-A19
O.D.: 6 1/4"



ELA 599SG

Gold Reflector
Lamp: 60W-A19
O.D.: 6 1/4"



ELA 599SW

White Reflector
Lamp: 60W-A19
O.D.: 6 1/4"



ELA 599GBZ

Gold Reflector
with Bronze Ring
Lamp: 60W-A19
O.D.: 6 1/4"



NEW!

ELA 599CCP

Clear Reflector with
Cooper Ring
Lamp: 60W-A19
O.D.: 6 1/4"



NEW!

ELA 5099B

ELA 5099C

ELA 5099G

ELA 5099W

Specular Reflector
with Socket Bracket,
White Trim
Lamp: PAR30-75W
R30-75W or 60W-A19
O.D.: 6 1/4"



5" Reflector Downlight Trims (Cont.)

ELM 501W

Airtight Metal Cone Reflector
Lamp: PAR30-75W
R30-75W
O.D.: 7 1/4"



ELS 530W

Specular White Reflector
Lamp: R30-PAR30-75W
O.D.: 6 1/4"



ELS 511C

Airtight Chrome Reflector Cone with Torsion Springs
Lamp: PAR30-75W
R30-75W
O.D.: 6 1/4"



ELS 530GG

ELS 530CC

Specular Gold Reflector with Gold Ring
O.D.: 6 1/4"



ELS 520C

ELS 520B

ELS 520G

ELS 520W

Specular Reflector
Lamp: PAR-R20-75W
O.D.: 6 1/4"



ELS 530KC

ELS 530KB

ELS 530KG

ELS 530KW

Specular Reflector with Lamp Holder Bracket
Lamp: R30-PAR30-75W
O.D.: 6 1/4"

NEW!



ELS 530B

Specular Black Reflector
Lamp: R30-PAR30-75W
O.D.: 6 1/4"



ELS 542C

ELS 542B

ELS 542G

ELS 542W

Regressed Albalite Lens with Reflector
Lamp: 60W-A19
O.D.: 6 1/4"



ELS 530C

Specular Clear Reflector
Lamp: R30-PAR30-75W
O.D.: 6 1/4"



ELS 5030C

ELS 5030G

ELS 5030W

Reflector with Lamp Holder Bracket and torsion springs
Lamp: PAR30-75
R30-75
O.D.: 6 1/4"



ELS 530G

Specular Gold Reflector
Lamp: R30-PAR30-75W
O.D.: 6 1/4"



5" IC Shower and Recess Lensed Trims

EL 512W
EL 512N
EL 512SH (white Lexan ring)
 Albalite Shower Trim
 Lamp: 60W-A19
 O.D.: 6 1/4"



EL 513BZ
 Fresnel Lens
 Shower Trim
 Lamp: 60W-A19
 O.D.: 6 1/4"

NEW!



EL 512BZ
 Albalite Shower Trim
 Lamp: 60W-A19
 O.D.: 6 1/4"

NEW!



EL 513CP
 Fresnel Lens
 Shower Trim
 Lamp: 60W-A19
 O.D.: 6 1/4"

NEW!



EL 512CP
 Albalite Shower Trim
 Lamp: 60W-A19
 O.D.: 6 1/4"

NEW!



EL 513KW
EL 513KSH (white Lexan ring)
 Fresnel Lens
 Shower Trim
 Lamp: 60W-A19
 O.D.: 6 1/4"



EL 512KW
EL 512KSH (white Lexan ring)
 Albalite Shower Trim
 with Bracket
 Lamp: 60W-A19
 O.D.: 6 1/4"



EL 5112W
 Shower Trim with
 Albalite Lens and
 Reflector
 Lamp: 60W-A19
 O.D.: 6 1/4"



EL 5113W
 Shower Trim with
 Fresnel Lens and
 Reflector
 Lamp: 60W-A19
 O.D.: 6 1/4"



EL 513N
EL 513W
EL 513SH (white Lexan ring)
 Fresnel Lens
 Shower Trim
 Lamp: 60W-A19
 O.D.: 6 1/4"



EL 514W
EL 514SH (white Lexan ring)
 Shower Trim with
 Lexan Ring and
 Round Drop Lens
 Lamp: 60W-A19
 O.D.: 6 1/4"



5" IC Shower and Recess Lensed Trims (Cont.)

EL 516BZ
Drop Opal
Shower Lens
Lamp: 60W-A19
O.D.: 6 1/4"

NEW!



EL 542B
Baffle with
Regressed
Albalite Lens
Lamp: 60W-A19
O.D.: 6 1/4"



EL 516CP
Drop Opal
Shower Lens
Lamp: 60W-A19
O.D.: 6 1/4"

NEW!



EL 542W
Baffle with
Regressed
Albalite Lens
Lamp: 60W-A19
O.D.: 6 1/4"



EL 516W
EL 516SH (white Lexan ring)
Drop Opal
Shower Lens
Lamp: 60W-A19
O.D.: 6 1/4"

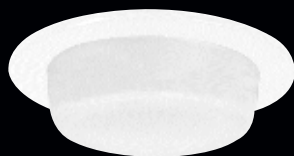

ELS 542C
ELS 542B
ELS 542G
ELS 542W
Regressed Albalite
Lens with Reflector
Lamp: 60W-A19
O.D.: 6 1/4"



EL 5116W
Drop Opal
Lens with Reflector
Lamp: 60W-A19
O.D.: 6 1/4"



EL 546B
EL 546W
Baffle with Regressed
Drop Opal Lens
Lamp: 60W-A19
O.D.: 6 1/4"



5" Adjustable Downlight Trims

EL 515W
Eyeball with Baffle
Lamp: 50W-R20-PAR20
O.D.: 6 1/4"



EL 518G
EL 518N
EL 518W
Eyeball
Lamp: PAR30-75W
O.D.: 6 1/4"



EL 517W
Adjustable
Gimbal Ring
Lamp: PAR30-75W
O.D.: 6 1/4"



EL 518BZ
Bronze Eyeball Trim
Lamp: PAR30-75W
R30-75W
O.D.: 6 1/4"

NEW!



5" Adjustable Downlight Trims (Cont.)

EL 518CP

Copper
Eyeball Trim
Lamp: PAR30-75W
O.D.: 6 1/4"

NEW!



EL 530KW

Open Trim
with Bracket
Lamp: PAR30-75W
O.D.: 6 1/4"



EL 519BB

EL 519CW

EL 519GG

EL 519WW

Reflector with
Regressed Eyeball
Lamp: PAR30-75W
O.D.: 6 1/4"



EL 530KBZ

Open Trim
with Bracket
Lamp: PAR30-75W
O.D.: 6 1/4"

NEW!



EL 519GGG

Regressed Eyeball
Lamp: PAR30-75W
O.D.: 6 1/4"

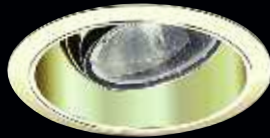

EL 575B

EL 575W

Regressed
Eyeball with Baffle
Lamp: PAR30-75W
O.D.: 6 1/4"



EL 521B

EL 521W

Metal Splay Reflector
Lamp: PAR30-75W
O.D.: 6 1/4"



EL 575BG

EL 575WG

Regressed
Eyeball with Baffle
Lamp: PAR30-75W
O.D.: 6 1/4"



EL 523W

EL 523B

Adjustable Baffle
with White Trim Ring
Lamp: PAR20-50W
R20-50W
I.D.: 3 3/8"
O.D.: 6 1/4"



EL 575BGG

EL 575WGG

Regressed
Eyeball with Baffle
Lamp: PAR30-75W
O.D.: 6 1/4"



EL 525W

EL 525B

EL 525C

EL 525G

Adjustable Reflector
with Lamp Holder Bracket
Lamp: PAR20-50W
R20-50W
I.D.: 3 3/8"
O.D.: 6 1/4"



EL 576B

EL 576W

Adjustable Regressed
Gimbal Ring with Baffle
Lamp: PAR30-75W
O.D.: 6 1/4"



EL 530BZ

Open Trim
Lamp: PAR30-75W
O.D.: 6 1/4"

NEW!



EL 577C

EL 577B

EL 577G

EL 577W

Adjustable
Regressed Gimbal
Ring with Reflector
Lamp: PAR30-75W
O.D.: 6 1/4"



5" Line Voltage Trim Compatibility Chart

Catalog No.	Description	ELCO	Halo	Juno
EL511	Metal Splay Baffle Trim	Y	Y	Y**
EL512	Albalite Shower Trim	Y	N***	Y
EL512K	Albalite Shower Trim	Y	Y	Y
EL513	Fresnel Shower Trim	Y	N***	Y
EL513K	Fresnel Shower Trim	Y	Y	Y
EL514	Shower Trim with Round Drop Opal Lens	Y	Y	Y***
EL515	Eyeball Trim for PAR20 Lamp	Y	Y*	Y
EL516	Drop Opal Shower Trim	Y	N***	Y
EL517	Adjustable Gimbal Ring Trim	Y	Y	Y
EL518	Eyeball Trim for PAR30 Lamp	Y	Y*	Y
EL519	Regressed Eyeball	Y	Y*	Y
EL530K	Open Trim with Bracket	Y	Y	Y
EL530	Open Trim	Y	N	Y
EL542	Regressed Albalite Lens with Baffle	Y	N	Y
EL575	Regressed Eyeball with Baffle	Y	Y*	Y
EL576	Black Adjustable Gimbal with Baffle	Y	Y	Y
EL577	Adjustable Gimbal with Reflector	Y	Y	Y
ELA501	Reflector with Baffle	Y	N	Y
ELA599	Aluminum Reflector Cone	Y	N	Y
ELA5099	Reflector Cone	Y	Y	Y***
ELM500	Airtight Baffle Trim	Y	N	Y
ELM501	Airtight Smooth Trim	Y	N	Y
ELM530	Metal Baffle Trim	Y	N	Y
ELM530K	Metal Baffle Trim	Y	Y	Y
ELM5033	Baffle	Y	Y	Y***
ELM5045	Wall Wash Baffle	Y	Y	Y***
ELP530K	Phenolic Baffle with Bracket	Y	Y	Y
ELP530	Phenolic Baffle	Y	N	Y
ELS511	Airtight Reflector Trim	Y	N	Y
ELS520	Aluminum Reflector for PAR20 or R20	Y	N	Y
ELS530	Aluminum Reflector for PAR30 or R30	Y	N	Y
ELS530K	Alumimum Reflector with Bracket	Y	Y	Y
ELS5030	Reflector with H Bracket	Y	Y	Y***

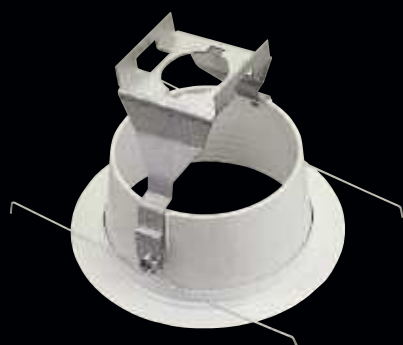

Universal Lampholder Bracket

permits the use of other manufacturers sockets and ELCO Lightings sockets.

U.S. Patent No. 6,364,511

Y = YES **N = NO**

*Order PSA27 Socket Adapter with this trim to fit Halo housings.

**Order PSA25 Socket Adapter with this trim to fit Juno housings.

***Can be special order to fit Halo Please consult factory.

ELCO LIGHTING

introduces...

COPPER & BRONZE



ELCO LIGHTING

Presents the Copper & Bronze Collection. Perfect for the contemporary designs of today. So warm, so bold, so cozy, so comfy... You'll never view lighting the same way again.



The Best Choice in Lighting

2042 E. Vernon Ave., Vernon, CA 90058

TEL 323-231-2600 FAX 323-231-3200

www.elcolighting.com

"We beat their **quality, availability,** and of course their **price**"

4" Miniature Downlight

Knockout for Flex

Romex with strain relief and 1/2" Conduit, Box (4 in and 4 out) maximum of 8 no. 12 AWG.

Junction Box

have extra large 32 cubic inch capacity, and are made of 16 gauge galvanized steel with snap-on covers for easy access from either side.

BOX (4 in and 4 out) maximum of 8 no. 12 AWG

Thermal Protector

Medium Base Socket

with red cap paint cover

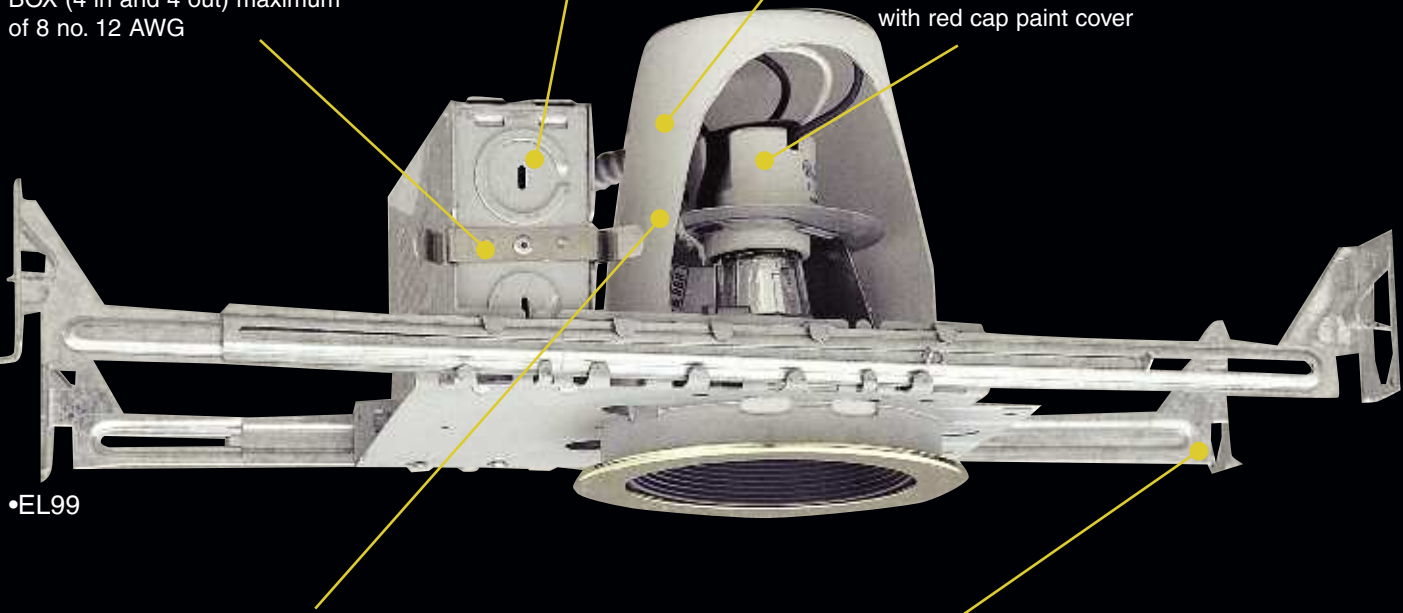

Adjustable Socket Mounting Plate

for adjustable lamp. Eliminates the need for a socket extension.

Hanger Bars

are Designed with large serrated barbs. Barb edge is sharpened and angled against the wood grain, allowing for nail free installation with maximum grip. Use universal hanger bar for residential, commercial of T-bar ceiling.

Junction Box

Knockouts for Flex

Romex with Strain Relief and 1/2" Conduit. BOX (4 in and 4 out) maximum of 8 no. 12 AWG. Eliminates the need for a wire connector saves Time, labor and money.

Romex Cable

4 ROMEX Knockouts with internal strain relief clips for easy installation,

Knockouts

for Romex

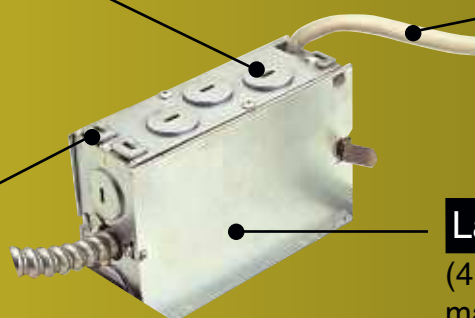

Large Junction Box

(4 in and 4 out) maximum of 8 no. 12 AWG

Available Trims

Baffle

EL 993BG

EL 993BB



Reflector

EL 999DG

EL 999C



Adjustable

EL 955B

EL 955W



Wall Wash

EL 992W

EL 992B



Accent Trims

EL 953BL

EL 952W



Dimensions

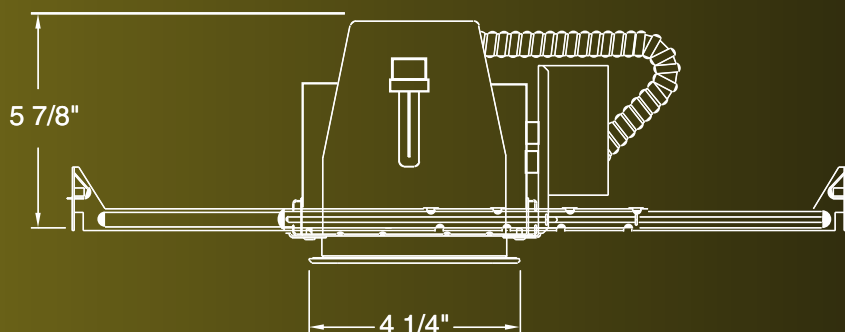

Lamps

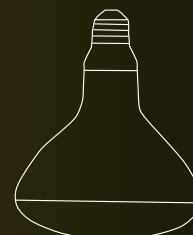

R20 - 50 Watt

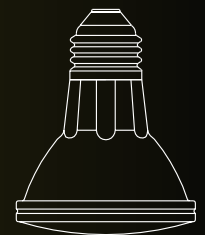

PAR20 - 50 Watt

4" Adjustable Miniature Housings

EL99, EL99A NEW!

4" Miniature Housing
Height: 5 1/2" - Ceiling Opening: 4 1/4"

- Adjustable mini recessed downlight does not need socket extension.
- Integral Thermal Protector guards against misuse of insulation materials and improper lamping.
- Junction box is listed for through branch circuit wiring and has four knockouts with true pryout slots.

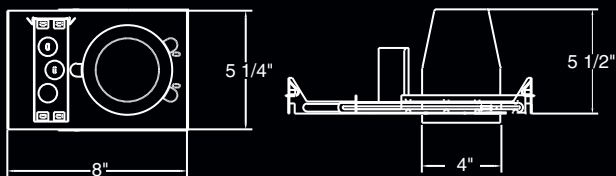

- Captive Bar Hangers will span 24" joists.
- 5 1/2" height allows installation in 2 x 6 construction.
- Housing can be removed from plaster frame for junction box access.
- Adjustable Socket Mounting Plate.
- UL Damp Location Listed
- A= ASTM Airtight Fixture

EL99ICA

4" Miniature Housing Type IC (Airtight)
Height: 5 7/8" - Ceiling Opening: 4 1/4"

- For installations where the housing will be in direct contact with ceiling insulation.
- Integral Thermal Protector guards against improper lamping.
- Junction Box is listed for through branch circuit wiring.

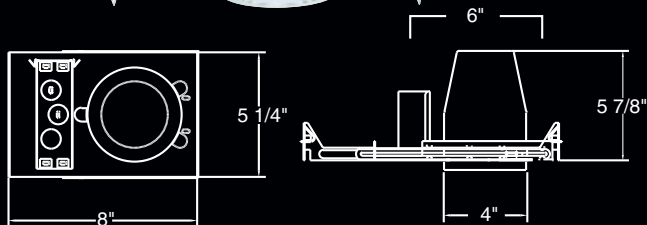

- Captive bar hangers will span 24" joists.
- Adjustable Socket Mounting Plate.
- UL Damp Location Listed
- UL Feed Through Listed
- A= ASTM Airtight Fixture

EL99IC

4" Miniature Housing Type IC
Height: 5 7/8" - Ceiling Opening: 4 1/4"

- For installations where the housing will be in direct contact with ceiling insulation.
- Double wall aluminum housing construction.
- Integral Thermal Protector guards against improper lamping.
- Junction Box is listed for through branch circuit.

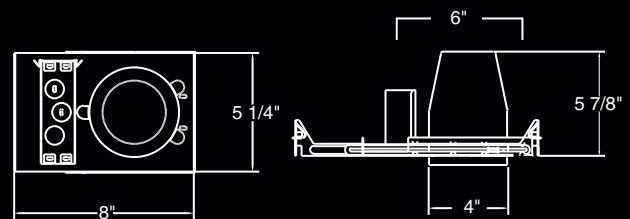

- Captive bar hangers will span 24" joists.
- Adjustable Socket Mounting Plate.
- UL Damp Location Listed
- UL Feed Through Listed

EL99R, EL99RA NEW!

4" Miniature Remodel Housing (Airtight)
Height: 5 7/8" - Ceiling Opening: 4 1/4"

- Adjustable socket Bracket, does not need socket extension.
- Integral Thermal Protector guards against misuse of insulation materials and improper lamping.
- Junction Box is listed for through branch circuit wiring and has four knockouts with true pryout slots.

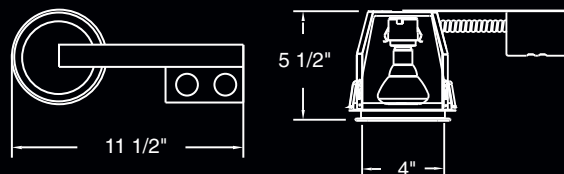

- UL Damp Location Listed
- UL Feed Through Listed
- A= ASTM Airtight Fixture

4" Miniature Baffle Trims

EL 993B

Black Phenolic Baffle
Lamp: 40W-R16, 40W-A19
PAR20-50W, or R20-50W
O.D.: 4 3/4"



EL 993W

White Phenolic Baffle
Lamp: 40W-R16
PAR20-50W, or R20-50W
O.D.: 4 3/4"



EL 993BB

EL 993BN

Phenolic Baffle
Lamp: PAR20-50W
R20-50W
O.D.: 4 3/4"



EL 993BBZ

NEW!

Black Baffle Trim
with Bronze Ring
Lamp: PAR20-50W R16-40W
or R20-50W
O.D.: 4 3/4"



EL 993BG

EL 993BC

Phenolic Baffle
Lamp: PAR20-50W
R20-50W
O.D.: 4 3/4"



EL 993BZW

NEW!

Bronze Baffle Trim
with White Ring
Lamp: A19-40W / PAR20-50W
R16-40W / R20-50W
O.D.: 4 3/4"



EL 993BZ

NEW!

Baffle Bronze Trim
Lamp: A19-40W/
PAR20-50W
R16-40W / R20-50W
O.D.: 4 3/4"



EL 993BCP

NEW!

Black Baffle Trim
with Copper Ring
Lamp: PAR20-50W R16-40W
or R20-50W
O.D.: 4 3/4"



EL 993CP

NEW!

Copper Baffle
Lamp: A19-40W
PAR20-50W or R16-40W
R20-50W
O.D.: 4 3/4"



EL 993CPB

NEW!

Copper Baffle
with Black Ring
Lamp: A19-40W / PAR20-50W
R16-40W / R20-50W
O.D.: 4 3/4"



EL 993N

EL 993NB

EL 993NW

Brushed Nickel
Metal Baffle
Lamp: 40W-R16, PAR20-
50W / R20-50W
O.D.: 4 3/4"



EL 993CPW

NEW!

Copper Baffle
with White Ring
Lamp: A19-40W / PAR20-50W
R16-40W or R20-50W
O.D.: 4 3/4"



4" Miniature Baffle Trims (Cont.)

EL 993WBZ

NEW!

White Baffle Trim
on Bronze Ring
Lamp: A19-40W / PAR20-50W
R16-40W / R20-50W
O.D.: 4 3/4"



EL 993KCPW

NEW!

Baffle with
Lampholder Bracket
Lamp: A19-40W / PAR20-50W
R16-40W or R20-50W
O.D.: 4 3/4"



EL 993WCP

NEW!

White Baffle
Trim on Copper Ring
Lamp: A19-40W / PAR20-50W
R16-40W or R20-50W
O.D.: 4 3/4"



EL 993KNB

Nickel Baffle Trim
with Black Ring with
Lampholder Bracket
Lamp: A19-40W / PAR20-50W
R16-40W / R20-50W
O.D.: 4 3/4"



EL 993KB

EL 993KN

EL 993KW

Metal Baffle with
Lampholder Bracket
Lamp: PAR20-50W
R20-50W
O.D.: 4 3/4"



EL 993KNW

Nickel Baffle Trim
with Black Ring with
Lampholder Bracket
Lamp: A19-40W / PAR20-50W
R16-40W / R20-50W
O.D.: 4 3/4"



EL 993KBN

Black Baffle Trim
with Nickel Ring
with Lampholder Bracket
Lamp: A19-40W / PAR20-50W
R16-40W / R20-50W
O.D.: 4 3/4"



EL 993MB

NEW!

Metal Baffle
Lamp: PAR20-50W
R20-50W
O.D.: 4 3/4"



EL 993KBZ

NEW!

Baffle with
Lampholder Bracket
Lamp: A19-40W / PAR20-50W
R16-40W / R20-50W
O.D.: 4 3/4"

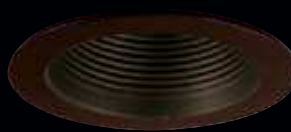

EL 993SW

EL 993SB

Baffle Trim with
special Clips and Socket
Lamp: PAR20-50W
R20-50W
O.D.: 4 3/4"



EL 993KCP

NEW!

Baffle with
Lampholder Bracket
Lamp: A19-40W / PAR20-50W
R16-40W or R20-50W
O.D.: 4 3/4"

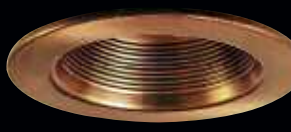

EL 994B

EL 994W

NEW!

Deep Phenolic
Baffle with Metal Ring
Lamp: 40W-R16, 40W-A19
PAR20-50W, or R20-50W
O.D.: 4 3/4"



4" Miniature Baffle Trims (Cont.)

EL 994BG

Phenolic Baffle
with Metal Ring
Lamp: PAR20-50W
R20-50W
O.D.: 4 3/4"



EL 995BZ

Baffle with Adjustable
Lampholder Bracket
Lamp: PAR20-50W
R20-50W
O.D.: 4 7/8"

NEW!



EL 994DW

EL 994DB

Deep Phenolic Baffle
with Diecast Ring
Lamp: 40W-R16, 40W-A19
PAR20-50W, or R20-50W
O.D.: 4 3/4"



EL 995CP

Baffle with Adjustable
Lampholder Bracket
Lamp: PAR20-50W,
R20-50W
O.D.: 4 7/8"

NEW!



EL 995W

EL 995B

EL 995N

Baffle with Adjustable
Lampholder Bracket
Lamp: PAR20-50W, R20-50W,
or PAR16-55W
O.D.: 4 3/4"



EL 941W

EL 941B

Diecast Stepped
Round Trim
Lamp: PAR20-50W,
R20-50W
O.D.: 4 3/4"



4" Wall Wash - Open Trims

EL 925C

EL 925G

EL 925W

Reflector Wall Wash
Lamp: PAR20-50W,
R20-50W, or A19-40W
O.D.: 4 3/4"



EL 992B

EL 992W

Wall Wash Trim
Lamp: PAR20-50W
R20-50W, or A19-40W
O.D.: 4 3/4"



EL 925KC

Reflector Wall Wash
with Bracket
Lamp: PAR20-50W,
R20-50W, or A19-40W
O.D.: 4 3/4"



EL 990BZ

Pinhole Trim
Lamp: PAR20-50W
R20-50W
O.D.: 4 3/4"

NEW!



EL 930W

Open Trim
Lamp: 50W PAR30
O.D.: 4 7/8"

NEW!



EL 990CP

Pinhole Trim
Lamp: PAR20-50W
R20-50W
O.D.: 4 3/4"

NEW!



EL 990W

EL 990N

Pinhole Trim
Lamp: R20-50W
PAR20-50W
O.D.: 4 3/4"



EL 992KW

Wall Wash Trim
with Bracket
Lamp: PAR20-50W
R20-50W, or A19-40W
O.D.: 4 3/4"



4" Reflector Trims

EL 901W

Airtight Smooth
Cone Reflector Trim
Lamp: PAR30-75W
O.D.: 4 3/4"



EL 999W

Reflector Trim
Lamp: R20-50W
PAR20-50W
O.D.: 4 3/4"



EL 999B

Reflector Trim
Lamp: R20-50W
PAR20-50W
O.D.: 4 3/4"



EL 999BZ

Reflector with
Bronze Ring
Lamp: PAR20-50W
PAR20-50W
O.D.: 4 3/4"

NEW!



EL 999C

Reflector Trim
PAR20-50W
O.D.: 4 3/4"



EL 999G

Reflector Trim
PAR20-50W
O.D.: 4 3/4"



EL 999CN

Chrome or Gold
Reflector with
Brushed Nickel Ring
Lamp: R20-50W
PAR20-50W
O.D.: 4 3/4"



EL 999GN

Chrome or Gold
Reflector with
Brushed Nickel Ring
Lamp: R20-50W
PAR20-50W
O.D.: 4 3/4"



EL 999GG

Gold Reflector
with Gold Ring or
Chrome Reflector
with Chrome Ring
Lamp: R20-50W
PAR20-50W
O.D.: 4 3/4"



EL 999CC

Gold Reflector
with Gold Ring or
Chrome Reflector
with Chrome Ring
Lamp: R20-50W
PAR20-50W
O.D.: 4 3/4"



EL 999CP

Copper Reflector
Trim, Copper Ring
Lamp: PAR20-50W
PAR20-50W
O.D.: 4 3/4"

NEW!



EL 999GBZ

Gold Reflector
Trim, Bronze Ring
Lamp: PAR20-50W
PAR20-50W
O.D.: 4 3/4"

NEW!



EL 999GCP

Reflector with
Copper Ring
Lamp: PAR20-50W
PAR20-50W
O.D.: 4 3/4"

NEW!



EL 999KCBZ

Reflector with
Lampholder Bracket
Lamp: A19-40W / PAR20-50W
R16-40W / R20-50W
O.D.: 4 3/4"

NEW!



EL 999KC

Reflector with
Lampholder Bracket
PAR20-50W
O.D.: 4 3/4"



EL 999KG

Reflector with
Lampholder Bracket
PAR20-50W
O.D.: 4 3/4"



EL 999DG

Reflector with
Diecast Ring
Lamp: R20-50W
PAR20-50W
O.D.: 4 3/4"



EL 999DC

Reflector with
Diecast Ring
Lamp: R20-50W
PAR20-50W
O.D.: 4 3/4"



4" Miniature Accent Trims

EL 926N

EL 926B

EL 926C

EL 926G

EL 926W

Chrome Reflector with
Suspended Frosted Glass
Lamp: 50W PAR20 or R20
O.D.: 4 3/4"



EL 926CP

Chrome Reflector
with Suspended
Frosted Lens, Copper Ring
Lamp: 50W PAR20 or R20
O.D.: 4 3/4"

NEW!



EL 952W

EL 952BL

EL 952R

Frosted Glass Trim
Lamp: PAR16-50W
O.D.: 4 3/4"



EL 926BZ

Chrome Reflector
with Suspended
Frosted Lens, Bronze Ring
Lamp: 50W PAR20 or R20
O.D.: 4 3/4"

NEW!



EL 953BL

EL 953W

Blue Frosted
Stepped Glass Trim
Lamp: PAR16-50W
R20-50W
O.D.: 4 3/4"



4" Line Voltage Square Trims

EL 2912 BZ
EL 2912W
 Shower Trim
 with Frosted Lens
 Lamp: R20-30W
 O.D.: 4 3/4"

NEW!



EL 2915 BZ
EL 2915W
 Shower Trim with
 Reflector and Frosted
 Pinhole Glass
 Lamp: R20-30W
 O.D.: 4 3/4"

NEW!



EL 2993W
EL 2993B
EL 2993BB
EL 2993BZ
EL 2993BBZ
EL 2993WBZ
 Phenolic Baffle
 Lamp: 40W-R16, 40W-A19
 PAR20-50W, or R20-50W
 O.D.: 4 3/4"

NEW!



EL 2994W
EL 2994B
 Deep Phenolic
 Baffle with Metal Ring
 Lamp: 40W-R16, 40W-A19
 PAR20-50W, or R20-50W
 O.D.: 4 3/4"

NEW!



EL 2999W
EL 2999B
EL 2999C
EL 2999G
EL 2999GBZ
 Reflector Trim
 PAR20-50W, R20-50W
 O.D.: 4 3/4"

NEW!



EL 29112BZ
EL 29112B
EL 29112W
 Shower Trim
 with Reflector
 and Frosted Lens
 Lamp: 40W-A19
 R20 / PAR20 -50W
 O.D.: 4 3/4"

NEW!



EL 29115W
EL 29115BZ
 Shower Trim with Reflector
 and Frosted Pinhole Glass
 Lamp: R20 / PAR20-50W
 40W-A19
 O.D.: 4 3/4"

NEW!



4" Adjustable Miniature Trims

EL 977C
EL 977W
 Clear Reflector
 with Adustable
 Lampholder Bracket
 Lamp: PAR20-50W
 PAR16-55W
 O.D.: 4 3/4"



EL 985BZ
 Adustable
 Gimbal Ring
 Lamp: PAR20-50W
 O.D.: 4 3/4"

NEW!



EL 977G
EL 977B
 Reflector with Adustable
 Lampholder Bracket
 Lamp: PAR20-50W
 PAR16-55W
 O.D.: 4 3/4"



EL 985CP
 Adustable
 Gimbal Ring
 Lamp: PAR20-50W
 O.D.: 4 3/4"

NEW!



EL 985N
EL 985B
EL 985W
 Adustable Gimbal Ring
 Lamp: PAR20-50W
 O.D.: 4 3/4"



EL 995W
EL 995B
 Baffle with Adustable
 Lampholder Bracket
 Lamp: PAR20-50W
 PAR16-55W
 O.D.: 4 3/4"



4" Miniature Shower Lights

EL 911W

EL 911SH (with Lexan ring)

Shower Trim
with Clear Lens
Lamp: R20-30W
O.D.: 4 3/4"



NEW!

EL 911CP

Shower Trim
with Clear Lens
Lamp: R20-30W
O.D.: 4 3/4"



NEW!

EL 911BZ

Shower Trim
with Clear Lens
Lamp: R20-30W
O.D.: 4 3/4"



NEW!

EL 9111W

EL 9111SH (with Lexan ring)

Shower Trim with
Clear Lens and Reflector
Lamp: R20-30W
O.D.: 4 3/4"



NEW!

EL 912CP

Shower Trim
with Frosted Lens
Lamp: R20-30W
O.D.: 4 3/4"



NEW!

EL 912BZ

Shower Trim
with Frosted Lens
Lamp: R20-30W
O.D.: 4 3/4"



NEW!

EL 912N

EL 912B

EL 912C

EL 912G

EL 912W

EL 912SH (with Lexan ring)

Shower Trim
with Frosted Lens
Lamp: R20-30W
O.D.: 4 3/4"



NEW!

EL 9112W

EL 9112B

EL 9112C

EL 9112G

EL 9112N

EL 9112SH (with Lexan ring)

Shower Trim
with Reflector
and Frosted Lens
Lamp: 40W-A19
R20 / PAR20 -50W
O.D.: 4 3/4"



NEW!

EL 9112BZ

Shower Trim
with Reflector
and Frosted Lens
Lamp: R20 / PAR20-50W
40W-A19
O.D.: 4 3/4"



NEW!

EL 9112CP

Shower Trim
with Reflector
and Frosted Lens
Lamp: R20 / PAR20-50W
40W-A19
O.D.: 4 3/4"



NEW!

EL 913CP

Shower Trim
with Fresnel Lens
Lamp: R20-30W
O.D.: 4 3/4"



NEW!

EL 913W

EL 913G

EL 913N

EL 913SH (with Lexan ring)

Shower Trim
with Fresnel Lens
Lamp: R20-30W
O.D.: 4 3/4"



NEW!

EL 913BZ

Shower Trim
with Fresnel Lens
Lamp: R20-30W
O.D.: 4 3/4"



NEW!

EL 9113W

EL 9113G

EL 9113SH (with Lexan ring)

Fresnel Lens
Shower Trim
with Reflector
Lamp: R20 / PAR20-50W
40W-A19
O.D.: 4 3/4"



NEW!

EL 9113BZ

Shower Trim
with Reflector
and Fresnel Lens
Lamp: R20 / PAR20-50W
40W-A19
O.D.: 4 3/4"



NEW!

EL 9113CP

Shower Trim
with Reflector
and Fresnel Lens
Lamp: R20 / PAR20-50W
40W-A19
O.D.: 4 3/4"

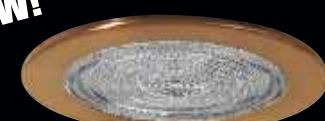

NEW!

EL 914W

EL 914B

EL 914SH (with Lexan ring)

Shower Trim
with Albalite Lens
Lamp: R20-30W
O.D.: 4 3/4"



NEW!

4" Miniature Shower Lights (Cont.)

EL 914BZ

Shower Trim
with Albalite Lens
Lamp: R20-30W
O.D.: 4 3/4"

NEW!



EL 914CP

Shower Trim
with Albalite Lens
Lamp: R20-30W
O.D.: 4 3/4"

NEW!



EL 9114W

EL 9114SH (with Lexan ring)
Shower Trim with
Reflector and Albalite Lens
Lamp: R20 / PAR20-50W
40W-A19
O.D.: 4 3/4"

NEW!



EL 9114BZ

Shower Trim with
Reflector and
Albalite Lens
Lamp: R20 / PAR20-50W
40W-A19
O.D.: 4 3/4"

NEW!



EL 9114CP

Shower Trim with
Reflector and Albalite Lens
Lamp: R20 / PAR20-50W
40W-A19
O.D.: 4 3/4"

NEW!



EL 915C

EL 915B

EL 915G

EL 915N

EL 915W

EL 915SH (with Lexan ring)
Shower Trim with Reflector and
Frosted Pinhole Glass
Lamp: R20-30W
O.D.: 4 3/4"

NEW!



EL 915BZ

Shower Trim with Reflector
and Frosted Pinhole Glass
Lamp: A19-40W / R20-30W
O.D.: 4 3/4"

NEW!



EL 915CP

Shower Trim with Reflector
and Frosted Pinhole Glass
Lamp: A19-40W / R20-30W
O.D.: 4 3/4"

NEW!



EL 9115W

EL 9115SH (with Lexan ring)
Shower Trim with Reflector
and Frosted Pinhole Glass
Lamp: R20 / PAR20-50W
40W-A19
O.D.: 4 3/4"

NEW!



EL 9115BZ

Shower Trim with
Reflector and
Frosted Pinhole Glass
Lamp: R20 / PAR20-50W
40W-A19
O.D.: 4 3/4"

NEW!



EL 9115CP

Shower Trim with
Reflector and
Frosted Pinhole Glass
Lamp: R20 / PAR20-50W
40W-A19
O.D.: 4 3/4"

NEW!



EL 916B

EL 916C

EL 916G

EL 916N

EL 916W

EL 916SH (with Lexan ring)
Shower Trim with Drop Opal Lens
Lamp: R20-30W
O.D.: 4 3/4"

NEW!



EL 916BZ

Shower Trim with Drop
Opal Lens
Lamp: R20-30W
O.D.: 4 3/4"

NEW!



EL 916CP

Shower Trim with Drop
Opal Lens
Lamp: R20-30W
O.D.: 4 3/4"

NEW!



EL 9116C

EL 9116B

EL 9116G

EL 9116W

EL 9116SH (with Lexan ring)
Shower Trim with
Reflector and
Drop Opal Lens
Lamp: PAR20/R20-50W,
A19-40W
O.D.: 4 3/4"

NEW!



EL 9116BZ

Shower Trim with
Reflector and
Drop Opal Lens
Lamp: R20 / PAR20-50W
40W-A19
O.D.: 4 3/4"

NEW!



4" Miniature Shower Lights (Cont.)

EL 9116CP

Shower Trim with Reflector and Drop Opal Lens
Lamp: R20 / PAR20-50W
40W-A19
O.D.: 4 3/4"

NEW!



EL 996W

Shower Trim with Round Drop Frosted Lens
Lamp: R20-30W
O.D.: 4 7/8"



4" Miniature Architectural Downlight Trims

EL 934WB

EL 934WW

Adjustable Deep Baffle
Lamp: JDR-50W
MR16-120V
(PSA28 or PSA29)
O.D.: 4 3/4"



EL 988BW

EL 988W

Adjustable Spot Trim
Lamp: JDR-50W
MR16-120V
(PSA28 or PSA29)
O.D.: 4 3/4"



EL 955B

Adjustable Spot Trim
Lamp: JDR-50W
MR16-120V
(PSA28 or PSA29)
O.D.: 4 3/4"



EL 998W

EL 998B

EL 998C

EL 998G

EL 998N

Eyeball Trim
Lamp: 40W-R16 R20-50W
PAR20-50W
O.D.: 4 3/4"



EL 955BW

Adjustable Spot Trim
Lamp: JDR-50W
MR16-120V
(PSA28 or PSA29)
O.D.: 4 3/4"



EL 998BZ

NEW!

Bronze Eyeball Trim
Lamp: R/PAR20-50W
R16-40W
O.D.: 4 3/4"



EL 955W

Adjustable Spot Trim
Lamp: JDR-50W
MR16-120V
(PSA28 or PSA29)
O.D.: 4 3/4"



EL 998CP

NEW!

Copper Eyeball Trim
Lamp: R/PAR20-50W
R16-40W
O.D.: 4 3/4"



EL 988B

EL 988G

Adjustable Spot Trim
Lamp: JDR-50W
MR16-120V
(PSA28 or PSA29)
O.D.: 4 3/4"



EL 998SW

EL 998SB

NEW!

White Eyeball Trim with special Clips and Socket
Lamp: R/PAR20-50W
MR16-120V
(PSA28 or PSA29)
O.D.: 4 3/4"



For use with EL99, EL99A, EL99R, EL99RA, EL99IC

EL 955B

Adjustable Spot Trim
Lamp: JDR-50W,
MR16-120V
O.D.: 4 3/4"

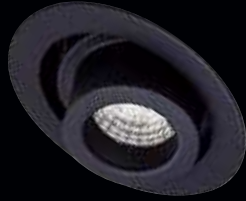

EL 988W

Adjustable Spot Trim
Lamp: JDR-50W
MR16-120V
O.D.: 4 3/4"



EL 955W

Adjustable Spot Trim
Lamp: JDR-50W,
MR16-120V
O.D.: 4 3/4"

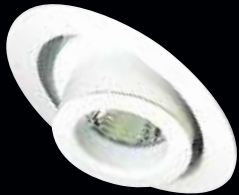

EL 998B

Eyeball Trim
Lamp: 40W-R16,
R20-50W, PAR20-50W
O.D.: 4 3/4"

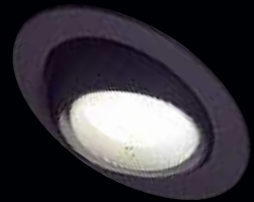

EL 977C

Adjustable Gimbal
Ring with Clear Reflector
Lamp: PAR20-50W
PAR16-55W
O.D.: 4 3/4"

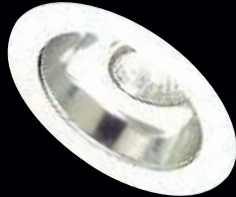

EL 998C

Eyeball Trim
Lamp: 40W-R16,
R20-50W, PAR20-50W
O.D.: 4 3/4"

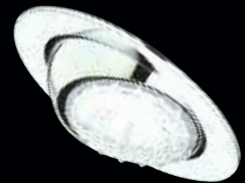

EL 977G

Adjustable Gimbal
Ring with Gold Reflector
Lamp: PAR20-50W
PAR16-55W
O.D.: 4 3/4"

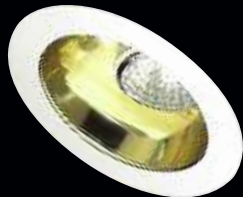

EL 998G

Eyeball Trim
Lamp: 40W-R16,
R20-50W, PAR20-50W
O.D.: 4 3/4"

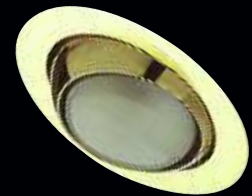

EL 988B

EL 988G

Adjustable
Gimbal Ring
Lamp: JDR-50W
PAR16-120W
O.D.: 4 3/4"

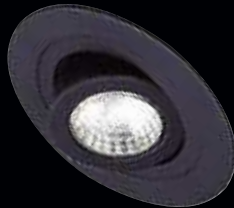

EL 998N

Eyeball Trim
Lamp: 40W-R16,
R20-50W, PAR20-50W
O.D.: 4 3/4"

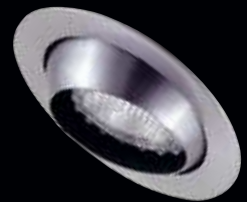

EL 988BW

Adjustable Spot Trim
Lamp: JDR-50W
PAR16-120W
O.D.: 4 3/4"



EL 998W

Eyeball Trim
Lamp: 40W-R16,
R20-50W, PAR20-50W
O.D.: 4 3/4"



4" Halogen Miniature Downlight and Trims

EL1299, EL1299R

4" Miniature Housing
 Height: 5 7/8" - Ceiling Opening: 4 1/4"
 Lamp: Line Voltage MR16-120V-45W
 No Transformer Required

- Junction box is listed for through branch circuit wiring and has four knockouts with true pryout slots
- Captive Bar Hangers will span 24" joists
- 5 7/8" Height allows installation in 2 x 6 construction
- Housing can be removed from plaster frame for junction box access
- U.L. Damp Location Listed

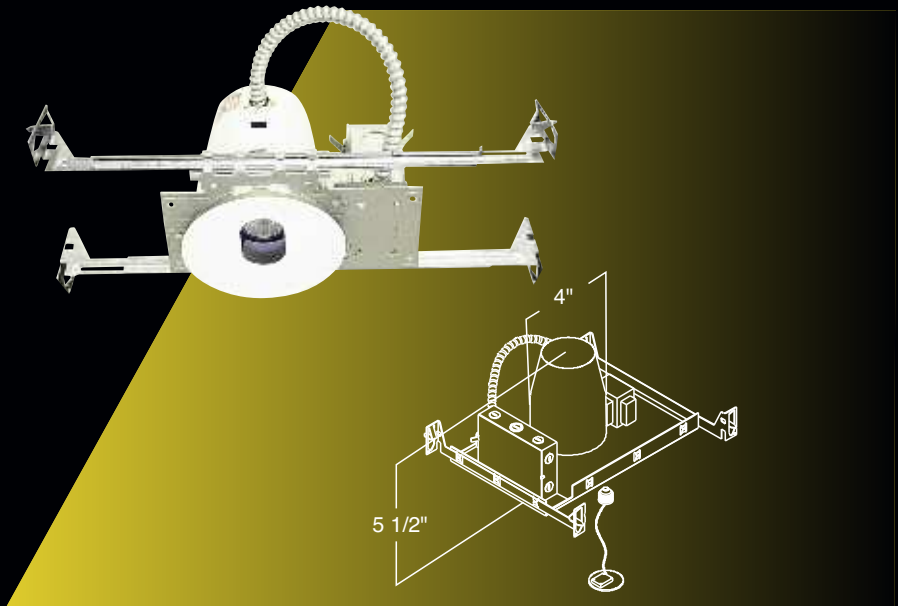

4" Halogen Downlight with Screw Base Adapter

Lamp: 120V-MR16-45W
No Transformer Required

Includes Lamp and Screw Base Adapter

A — **EL99, EL99A**
 4" Halogen Downlight with Screw Base Adapter
 Height: 5 1/2" - Ceiling Opening: 4 1/4"

B — **PSA28**
 • Screw Adapter with MR16 Socket.
 • For Retrofit on New or Remodel Construction.
 Lamp: 120V/45W MR16

C — **Trims**
 • 4" Low Voltage Trims

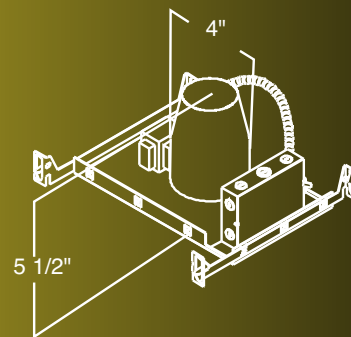

- Integral Thermal Protector guards against misuse of insulation materials and improper lamping.
- Junction box is listed for through branch circuit wiring and has seven knockouts with true pryout slots.
- Captive Bar Hangers will span 24" joists.
- U.L. Damp Location Listed

- 5 1/2" height allows installation in 2 x 6 construction
- Housing can be removed from plaster frame for junction box access
- U.L. Damp Location listed
- A= ASTM Airtight Fixture



3" Line Voltage Housings

EL39A

NEW!

- Height : 4 7/8"
- Opening: 3 5/8"
- Hole Cutout: 3 3/4"
- Lamp: 50W MAX. 120V GU10 base lamp
- A= ASTM Airtight Fixture



Housing with thermal protector. Supplied with captive bar hangers for 24" joist spacing. UL listed for damp locations.

EL39RA

NEW!

- Height : 5 3/8"
- Opening: 3 5/8"
- Hole Cutout: 3 3/4"
- Lamp: 50W MAX. 120V GU10 base lamp
- A= ASTM Airtight Fixture

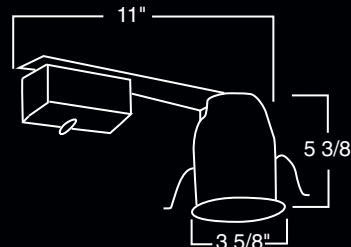
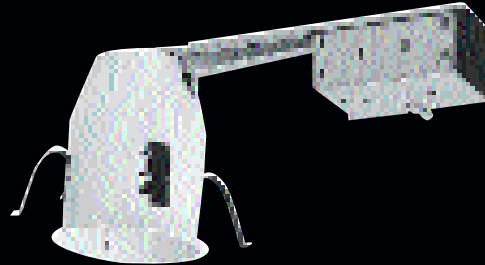

Remodel housing with thermal protector. UL listed for damp locations.

EL39ICA

NEW!

- Height : 5 1/4"
- Opening: 3 5/8"
- Hole Cutout: 3 3/4"
- Lamp: 120V GU10 base lamp
- A= ASTM Airtight Fixture

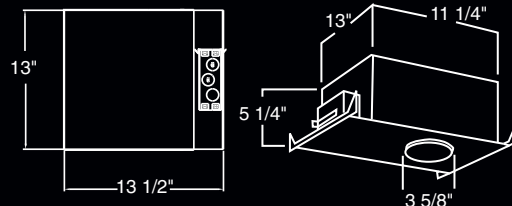

Double wall IC housing with thermal portector. For use in insulated ceilings. Supplied with captive bar hangers for 24" joist spacing. UL listed damp locations.

EL 2612W

Die Cast Lensed Shower Trim with Diffused Glass Lens
Lamp: 50W MAX MR16, 120V, GU10 Base.
O.D.: 4 5/16"



EL 2616C

EL 2616B

EL 2616W

Die Cast Shower Trim with Dome Glass Lens
Lamp: 50W MAX MR16, 120V, GU10 Base.
O.D.: 4 5/16"



EL 2613W

Die Cast Lensed Shower Trim
Lamp: 50W MAX MR16, 120V, GU10 Base.
O.D.: 4 5/16"



3" Line Voltage Accent Trims

EL 2619WC

EL 2619WB

Die Cast Pinhole Trim with Reflector
Lamp: 50W MAX MR16, 120V, GU10 Base.
O.D.: 4 3/8", 2" Aperture



EL 2653BL

Die Cast Accent Trim
Lamp: 50W MAX MR16, 120V, GU10 Base.
O.D.: 4 5/16"



EL 2620W

Die Cast Slot Aperture Trim
50° Adjustability
Lamp: 50W MAX MR16, 120V, GU10 Base.
O.D.: 4 5/16"



EL 2653W

Die Cast Accent Trim
Lamp: 50W MAX MR16, 120V, GU10 Base.
O.D.: 4 5/16"



EL 2652BL

Die Cast Round Glass Trim
Lamp: 50W MAX MR16, 120V, GU10 Base.
O.D.: 4 5/16"



EL 2660W

EL 2660B

EL 2660C

Die Cast Offset Glass Panel Trim
Lamp: 50W MAX MR16, 120V, GU10 Base.
O.D.: 4 5/16"



EL 2652W

Die Cast Round Glass Trim
Lamp: 50W MAX MR16, 120V, GU10 Base.
O.D.: 4 5/16"



3" Line Voltage Adjustable Trims

EL 2621W
 EL 2621B
 EL 2621C
 EL 2621G
 EL 2621BB
 EL 2621CC
 EL 2621CN
 EL 2621GG
 EL 2621GN

NEW!



Die Cast
 Adjustable
 Reflector Trim
 35° Adjustability
 Lamp: 50W MAX MR16,
 120V, GU10 Base
 O.D.: 4 5/16"

EL 2622CP

NEW!



Die Cast Adjustable
 Wall Wash Reflector Trim
 45° Adjustability
 Lamp: 50W MAX MR16,
 120V, GU10 Base.
 O.D.: 4 5/16"

EL 2624N
 EL 2624B
 EL 2624W

NEW!



Adjustable Wall
 Wash Baffle Trim
 45° Adjustability
 Lamp: 50W MAX MR16,
 120V, GU10 Base.
 O.D.: 4 5/16"

EL 2621BZ **NEW!**



Die Cast
 Adjustable
 Reflector Trim
 35° Adjustability
 Lamp: 50W MAX MR16,
 120V, GU10 Base
 O.D.: 4 5/16"

EL 2624CP

NEW!



Adjustable Wall
 Wash Baffle Trim
 45° Adjustability
 Lamp: 50W MAX MR16,
 120V, GU10 Base.
 O.D.: 4 5/16"

EL 2621CP **NEW!**



Die Cast
 Adjustable
 Reflector Trim
 35° Adjustability
 Lamp: 50W MAX MR16,
 120V, GU10 Base
 O.D.: 4 5/16"

EL 2633W
 EL 2633B



Die Cast Louvered Trim
 Lamp: 50W MAX MR16,
 120V, GU10 Base.
 O.D.: 4 5/16"

EL 2622W
 EL 2622B
 EL 2622C
 EL 2622G
 EL 2622N



Die Cast Adjustable
 Wall Wash Reflector Trim
 45° Adjustability
 Lamp: 50W MAX MR16,
 120V, GU10 Base.
 O.D.: 4 5/16"

EL 2644B
 EL 2644C
 EL 2644G
 EL 2644W



Reflector with Cross
 Blade Trim
 45° Adjustability
 Lamp: 50W MAX MR16,
 120V, GU10 Base.
 O.D.: 4 5/16"

3" Line Voltage Adjustable Trims (Cont.)

EL 2693N
EL 2693B
EL 2693W
EL 2693BB
EL 2693BN
EL 2693WN

Die Cast Adjustable
 Baffle Trim
 35° Adjustability
 Lamp: 50W MAX MR16,
 I20V, GU10 Base.
 O.D.: 4 5/16"



EL 2693WCP

Die Cast Adjustable
 Baffle Trim
 35° Adjustability
 Lamp: 50W MAX MR16,
 I20V, GU10 Base.
 O.D.: 4 5/16"



EL 2693BZ

Die Cast Adjustable
 Baffle Trim
 35° Adjustability
 Lamp: 50W MAX MR16,
 I20V, GU10 Base.
 O.D.: 4 5/16"



EL 2695W

Adjustable Wall Wash
 Scoop with Baffle
 Lamp: 50W MAX MR16,
 I20V, GU10 Base.
 O.D.: 4 5/16"



EL 2693CP

Die Cast Adjustable
 Baffle Trim
 35° Adjustability
 Lamp: 50W MAX MR16,
 I20V, GU10 Base.
 O.D.: 4 5/16"



EL 2698WW

EL 2698WB
 Die Cast
 Adjustable Eyeball Trim
 Lamp: 50W MAX MR16,
 I20V, GU10 Base.
 O.D.: 4 5/16"



3" Line Voltage Sloped Ceiling

EL 2688W
EL 2688B
EL 2688C
EL 2688N

Die Cast Adjustable
 Pull Down Trim
 30° Adjustability
 358° Rotation
 Lamp: 50W MAX MR16,
 I20V, GU10 Base.
 O.D.: 4 5/16"



EL 2688CP

Die Cast
 Adjustable
 Pull Down Trim
 30° Adjustability
 358° Rotation
 Lamp: 50W MAX MR16,
 I20V, GU10 Base.
 O.D.: 4 5/16"



EL 2688BZ

Die Cast
 Adjustable
 Pull Down Trim
 30° Adjustability
 358° Rotation
 Lamp: 50W MAX MR16,
 I20V, GU10 Base.
 O.D.: 4 5/16"



EL 2689WW

EL 2689BB
EL 2689WB
 Die Cast
 Adjustable
 Deep Baffle
 35° Adjustability
 358° Rotation
 Lamp: 50W MAX MR16,
 I20V, GU10 Base.
 O.D.: 4 5/16"



3" Incandescent Remodel Downlight

RR300W

Open (Complete Fixture)
Lamp: R20, PAR20
50W Max.
5" O.D.



RR301B

With Baffle Trim
(Complete Fixture)
Lamp: R20, PAR20
50W Max.
5" O.D.



RR301W

With Baffle Trim
(Complete Fixture)
Lamp: R20, PAR20
50W Max.
5" O.D.



RR302W

With Eyeball Trim (Complete
Fixture)
Lamp: R20, PAR20
50W Max.
5" O.D.



Elco Lightings

POCKET CATALOG



This catalog has important and helpful information including:

- Sloped Ceiling
- Recessed Downlights
- Low Voltage Downlights
- Halogen Downlights
- Compact Fluorescent
- Track Lighting
- Fluorescent Trims
- Retrofit Housings
- Undercabinet
- Duralight
- Decolume
- Step Lights
- Wall Packs

To order our "Pocket Catalog" please contact us at Elco Headquarters

Low Voltage

At Elco Lighting we use the highest quality low voltage transformers in the market. An innovative leader in lighting technology, Elco Lighting offers a diverse selection of low voltage housings and trims in 3", 4", 5" and 6" apertures. Low voltage MR11 and MR16 lamps produce excellent color rendition and a variety of beam spreads to help you achieve dramatic accent lighting results. Our wide selection of tilt adjustable trims (0 to 90 degrees) provides the greatest flexibility for your lighting environment. The most comprehensive low voltage downlight fixtures in the market, Elco's extensive line includes such hard-to-find options as 5" and 6" low voltage retrofit trims, and low voltage options in 50W and 75W, 120V and 277V downlights. All product specification sheets can be downloaded from our website at www.elcolighting.com

59-95

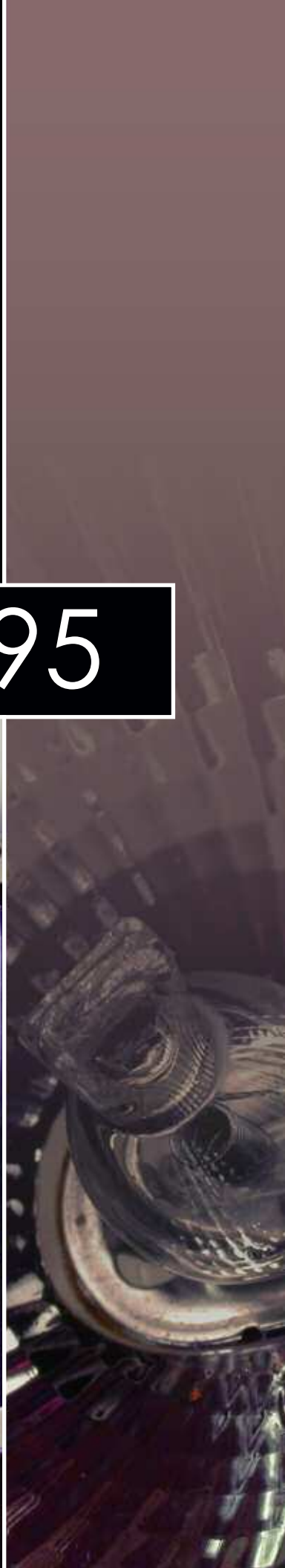

6" Low Voltage Recessed Downlight

EL7LV, EL7LV-277

6" Standard Low Voltage Housing
 Height: 7 1/2" - Opening: 6 1/2"
 Lamp: 12V-75W-MR16 or PAR36

- Low voltage housing utilizes MR16 or PAR36 halogen lamps.
- Complete with 12 volt thermally protected Magnetic transformer.
- Captive hanger bars span 24" joists and can be repositioned 90 degrees.
- 7 1/2" Height allows for use in 2 x 8 construction.

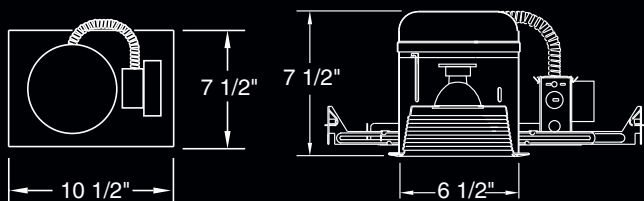

- Housing adjusts 1 3/8" to accommodate various ceiling thickness.
- U.L. Listed for damp location
- U.L. Feed through Listed

EL7RLV, EL7RLV-277

6" Low Voltage Remodel Housing
 Height: 7 1/2" Opening: 6 3/8"
 Lamp: 12V-75W MR16 / PAR36

- Low voltage remodel housing utilizes MR16 or Par36 halogen lamps.
- Complete with 12 volt thermally protected Magnetic transformer.
- 7 1/2" height allows for use in 2 x 8 construction.



- Housing clips adapt to various ceiling thickness.
- U.L. Listed for damp location
- U.L. Feed through Listed

6" IC Low Voltage Housing

EL7LVICA

Low Voltage IC Airtight Housing
 Height: 7 1/2" - Opening: 6 1/2"
 Lamp: 12V 50W MR16

- UL listed for use in direct contact with thermal insulation.
- Integral thermal protector
- Integral magnetic transformer steps line voltage down to lamp operating voltage.

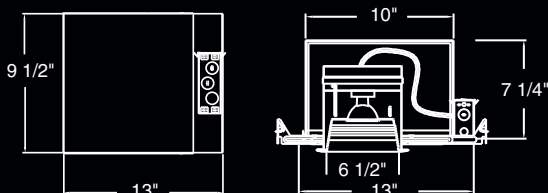

- Junction box is listed for through branch circuit wiring with knockouts and true pry-out slots.
- Captive bar hangers will span 24" joists and can be repositioned 90°
- 7 1/2" height allows use in 2 x 8 construction.
- Housing can be removed from plaster frame for junction box access.
- A= ASTM Airtight

6" Architectural Low Voltage Housing

ELH7LV, ELH7LV-277

6" Low Voltage Housing
 Height: 7 1/2" - Opening: 6 1/2"
 Lamp: 12V 75W MR16 Par36

- 6" Architectural Low Voltage Housing.
- Thermal protector provides positive protection against over lamping
- UL Listed for Damp locations

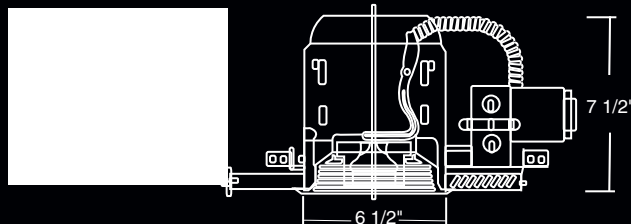

- UL Damp Location Listed
- UL Feed Through Listed
- A= ASTM Airtight Fixture

6" Low Voltage Adjustable Trims

EL 2510B
EL 2510N
Adjustable
Spot Baffle Trim
Lamp: MR16-75W
O.D.: 7 1/4"



EL 2516G
EL 2516C
EL 2516W
Adjustable
Reflector Trim
Lamp: MR16-75W
O.D.: 7 1/4"



EL 2510W
Adjustable
Spot Baffle Trim
Lamp: MR16-75W
O.D.: 7 1/4"



EL 2517W
EL 2517WW
Eyeball Trim
Lamp: MR16-75W
O.D.: 7 1/4"



EL 2510BZ **NEW!**
Adjustable
Spot Baffle Trim
Lamp: MR16-75W
O.D.: 7 1/4"



EL 2518B
Regressed Eyeball
Lamp: MR16-75W
O.D.: 7 1/4"



EL 2510CP **NEW!**
Adjustable
Spot Baffle Trim
Lamp: MR16-75W
O.D.: 7 1/4"



EL 2518W
Regressed Eyeball
Lamp: MR16-75W
O.D.: 7 1/4"



EL 2511B
EL 2511W
Adjustable
Spot with Reflector
Lamp: MR16-75W
O.D.: 7 1/4"



EL 2521B
EL 2521W
Adjustable
Cone Reflector
Lamp: MR16-75W
I.D.: 3 1/2"
O.D.: 8"



EL 2511C
Adjustable
Spot with Reflector
Lamp: MR16-75W
O.D.: 7 1/4"



EL 2521C
EL 2521G
Adjustable
Cone Reflector
Lamp: MR16-75W
I.D.: 3 1/4"
O.D.: 8"



EL 2511G
Adjustable
Spot with Reflector
Lamp: MR16-75W
O.D.: 7 1/4"



EL 2525B
EL 2525W
Adjustable Wall Wash
Lamp: MR16-75W
I.D.: 3 1/2"
O.D.: 8"



EL 2512B
EL 2512W
Shower Trim
with Diffused Lens
Lamp: MR16-75W
O.D.: 7 1/4"



EL 2529W
EL 2529B
Adjustable
Pinhole Reflector
Lamp: MR16-50W
O.D.: 8"



6" Low Voltage Adjustable Trims (Cont.)

EL 2530B

Adjustable Downlight
with Black Baffle
Lamp: MR16-75W
O.D.: 7 1/4"



EL 2530W

Adjustable Downlight
with White Baffle
Lamp: MR16-75W
O.D.: 7 1/4"



EL 2531B

EL 2531W
Baffle with
Adjustable Cylinder
Lamp: MR16-75W
O.D.: 7 1/4"



EL 2533B

EL 2533W
Adjustable Baffle Trim
Lamp: 12V-75W-MR16
I.D.: 3 1/2"
O.D.: 7 1/4"



EL 2533BZ

EL 2533BBZ
Adjustable Baffle Trim
Lamp: MR16-75W-12V
O.D.: 8"

NEW!



EL 2533CP

EL 2533BCP
Adjustable Baffle Trim
Lamp: MR16-75W-12V
O.D.: 8"

NEW!



EL 2545W

EL 2545B
Adjustable Wall Wash
Lamp: MR16-75W
O.D.: 7 1/4"



EL 2550W

Adjustable Slot Aperture
Lamp: MR16-75W
Slot: 1 3/8" x 2 1/4"
O.D.: 8"



EL 2568B

EL 2568W
Adjustable Spot Trim
Lamp: MR16-75W
Slot: 1 3/8" x 2 1/4"
O.D.: 7 1/4"



EL 2575B

EL 2575N
Adjustable Trim
Lamp: PAR36-50-75W
O.D.: 7 1/4"



EL 2575W

Adjustable
Downlight with Baffle
Lamp: PAR36-50-75W
O.D.: 7 1/4"



EL 2576W

EL 2576B
Adjustable Trim
with Reflector
Lamp: PAR36-75W
O.D.: 7 1/4"



EL 2576C

EL 2576G
Adjustable Downlight
with Reflector
Lamp: PAR36-50-75W
O.D.: 7 1/4"



EL 2579W

EL 2579B
Pinhole Downlight
Lamp: MR16-50W
I.D.: 1 7/8"
O.D.: 8"



EL 2587W

EL 2587B
Adjustable Spot Trim
45° Vertical Adjustment
Lamp: MR16-75W
O.D.: 7 1/4"



6" Low Voltage Adjustable Trims (Cont.)

EL 2588W
EL 2588B
Adjustable Spot Trim
45° Vertical Adjustment
Lamp: MR16-75W
O.D.: 7 1/4"



EL 2597W
Drop Adjustable Trim
Ring: 0° -90°
Lamp: MR16-75W
O.D.: 7 1/4"



EL 2589W
Gimbal Ring
Tilt 0° -90°
Adjustable Trim
Lamp: MR16-75W
O.D.: 8"



EL 2597BZ **NEW!**
Adjustable Pull Down
Tilt 0° -90°
Rotates 359°
Lamp: MR16-75W
O.D.: 7 1/4"



EL 2597B
EL 2597N
Adjustable Pull Down
Ring: 0° -90°
Lamp: MR16-75W
O.D.: 7 1/4"



EL 2597CP **NEW!**
Adjustable Pull Down
Tilt 0° -90°
Rotates 359°
Lamp: MR16-75W
O.D.: 7 1/4"



6" Miniature Frosted Downlight

EL 2552BL
EL 2552R
EL 2552W
Frosted Glass Trim
Lamp: MR16-75W
O.D.: 8"



EL 2553W
EL 2553BL
Frosted Stepped Glass
Lamp: MR16-75W
O.D.: 8"



Elco Lighting's Copper & Bronze Catalog

- Low Voltage Trims
- Line Voltage Trims
- Compact Fluorescent Trims
- Miniature Halogen Recessed
- Recessed Lighting Accessories
- Track Lighting

To order our "Copper & Bronze Catalog" please contact us at Elco Headquarters.

6" Low Voltage Retrofit

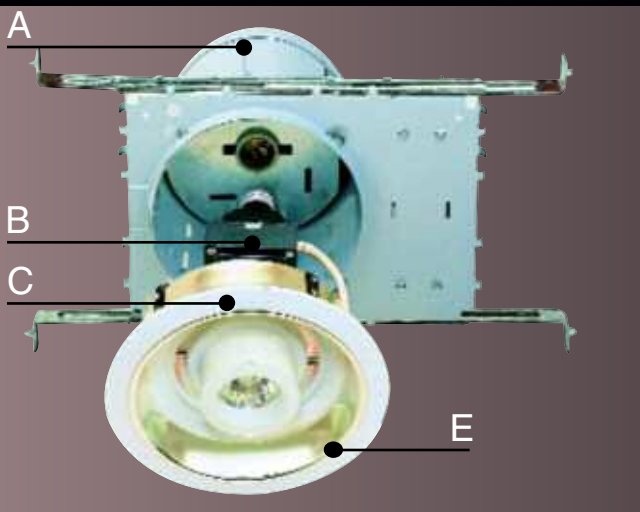

- A 6" Universal Housing
- B 12 Volt 50VA transformer ETRK50, screws into housing's socket (ETRK50E Electronic Transformer optional)
- C Socket for MR16 lamp inside cylinder
- D Low Voltage Retrofit Trims
20W, 42W, 50W MR16 or 25W, 50W, PAR36
- E Trims available in Baffle, Reflector and Cylinder

NOTE: 50W max for Non IC housings, and 20W for IC housings.

Low Voltage Retrofit Kit

Permits conversion of existing fixtures to use low voltage MR16 Lamps. The transformer is shipped with the trim assembly and attaches electronically to the socket within the housing. Each fixture functions as downlight or adjustable.

6" Low Voltage Retrofit Trims

Includes Transformer

EL 1510W

EL 1510B

EL 1510N

Adjustable Spot Trim

Lamp: MR16-50W

O.D.: 7 1/4"



EL 1510BZ

Adjustable

Spot Trim

Lamp: MR16-50W

O.D.: 7 1/4"

NEW!



EL 1510CP

Adjustable

Spot Trim

Lamp: MR16-50W

O.D.: 7 1/4"

NEW!



EL 1511C

EL 1511B

EL 1511G

EL 1511W

Adjustable Spot

with Reflector

Lamp: MR16-50W

O.D.: 7 1/4"



EL 1512B

EL 1512W

Shower with diffused Lens

Lamp: MR16 / 50W

O.D.: 7 1/4"



EL 1516C

EL 1516B

EL 1516G

EL 1516W

Adjustable

Reflector Trim

Lamp: MR16-50W

O.D.: 7 1/4"



EL 1521C

EL 1521B

EL 1521G

EL 1521W

Adjustable

Cone Reflector

Lamp: MR16-50W

O.D.: 8"



EL 1530B

EL 1530W

Baffle Adjustable

Downlight

Lamp: MR16-50W

O.D.: 7 1/4"



EL 1552BL

EL 1552R

EL 1552W

Frosted Downlight

Lamp: 20-42-50

50W-MR16

O.D.: 8"



EL 1553BL

EL 1553W

Frosted Downlight

Lamp: 12V 50W MR16

O.D.: 8"



6" Retrofit Low Voltage Downlight Trims

EL 1518B
EL 1518W
Regressed Eyeball
Lamp: MR16-50W
OD: 7 1/4"



EL 1531B
EL 1531W
Black Baffle with
Adjustable Cylinder
Lamp: 20-42-50W-MR16
OD: 7 1/4"



EL 1533B
EL 1533W
Adjustable Baffle
Lamp: 20-42-50W-MR16
OD: 8"



EL 1550W
Adjustable Slot
Aperture Trim
Lamp: MR16-50W
OD: 8"



EL 1568W
EL 1568B
Adjustable Spot
Lamp: MR16 / 20-42-50W
OD: 7 1/4"



EL 1575B
EL 1575N
EL 1575W
Adjustable Gimbal Trim
Lamp: PAR36-50W
OD: 7 1/4"



EL 1576C
EL 1576G
Adjustable
Gimbal with Reflector
Lamp: PAR36-50W
OD: 7 1/4"



EL 1576W
EL 1576B
Adjustable Gimbal
with Reflector
Lamp: PAR36-50W
OD: 7 1/4"



EL 1579W
Pinhole Downlight
Lamp: MR16-50W
OD: 8"



EL 1587W
EL 1587B
Adjustable
Pull Down Trim with Snoot
Lamp: MR16/ 20-42-50W
OD: 7 1/4"



EL 1588W
EL 1588B
Adjustable Spot Trim
Lamp: MR16-50W
OD: 7 1/4"



EL 1589W
Adjustable Trim
with Gimbal Ring
0°-90° tilt
Lamp: MR16
20-42-50W
OD: 8"



EL 1597B
Adjustable Pull Down
0°-90° tilt
Lamp: MR16-50W
OD: 7 1/4"



EL 1597W
Adjustable Pull Down
0°-90° tilt
Lamp: MR16
20-42-50W
OD: 7 1/4"



EL 1597BZ **NEW!**
Adjustable Pull Down
0°-90° tilt
Rotates 359°
Lamp: MR16 20-50W Max
OD: 7 1/4"



EL 1597CP **NEW!**
Adjustable Pull Down
with Transformer
0°-90° tilt
Rotates 359°
Lamp: MR16 20-50W Max
OD: 7 1/4"



Low Voltage Sloped Downlight Retrofit Kits

A A Sloped Ceiling Universal Housing

C Socket for MR16 Lamp Inside Cylinder

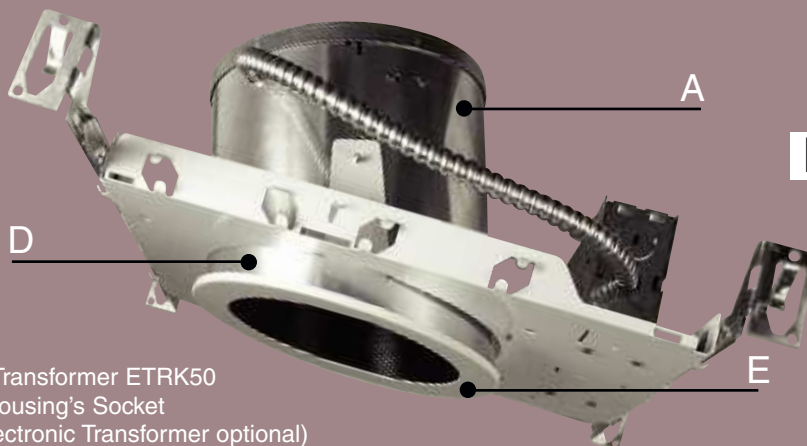

B 12 Volt 50VA Transformer ETRK50
Screws Into Housing's Socket
(ETRK50E Electronic Transformer optional)

D Low Voltage for Retrofit
Trims for: 20W, 42W, 50W
MR16 or 25W, 50W, PAR36

E Trims available in:
Baffle, Reflector or
Cylinder Low Voltage
Trims

- Low voltage sloped retrofit kit permits conversion of existing fixtures to use low voltage MR16 lamps.
- Remodeling low voltage thermally protected with individual 50W magnetic transformer.
- The transformer is shipped with the trim assembly and attaches electrically to the socket within the housing. Each trim functions as downlight or adjustable (ETRK50E Electronic Transformer optional)
- Designed for use in ceiling with slopes from 2/12 to 12/12.

NOTE: 50W max for Non IC housings, and 20W for IC housings.

6" Low Voltage Retrofit Trims

EL 1610B
EL 1610W
Adjustable
Spot with Baffle
Lamp: MR16-50W
O.D.: 8"



EL 1621B
EL 1621W
Adjustable Reflector
and Baffle Trim
Lamp: MR16-50W
O.D.: 7 5/8" x 7 7/8"



EL 1611W
EL 1611B
EL 1611C
EL 1611G
Adjustable Spot
with Reflector
Lamp: MR16-50W
O.D.: 8"



EL 1675B
Adjustable Spot Trim
Lamp: PAR36-50W
O.D.: 7 5/8" x 7 7/8"



EL 1612W
EL 1612B
Adjustable Spot Trim
Lamp: MR16-50W
O.D.: 8"



EL 1675W
Adjustable Trim
Lamp: PAR36-50W
O.D.: 7 5/8" x 7 7/8"



EL5LV

5" Low Voltage Housing
 Height: 7 1/2" - Ceiling Opening: 5 1/2"
 Lamp: 12V 75W MR16

- Versatile, reliable and easy to install.
- Integral thermal protector guards against misuse of insulation materials and improper lamping.
- Magnetic 75W Transformer included.
- Trim assembly and lamp not included.
- Junction box is listed for through branch circuit wiring and has 1/2" knockouts with true pry-out slots.

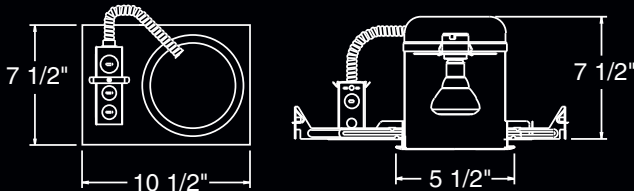

- Captive bar hangers span 24" joists and can be repositioned 90°.
- 7 1/2" height allows for use in 2 x 8 construction.
- Housing adjusts 1 3/8" to accommodate various ceiling thicknesses.
- UL listed damp location.
- UL listed feed through.

EL5RLV

5" Remodel Housing
 Height: 7 1/2" - Ceiling Opening: 5 1/2"
 Lamp: 12V 75W MR16

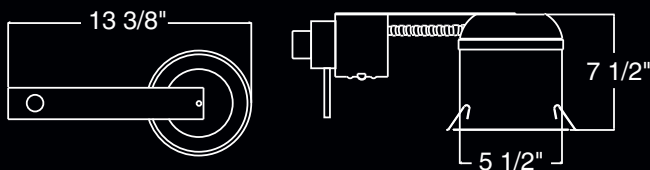

- Integral thermal protector guards against misuse of insulation materials and improper lamping.
- Magnetic 75W transformer included.
- Trim assembly and lamp not included.
- To cut exact size ceiling hole, use Elco EL5000 tool.
- Wiring box for use with 75°C supply wire.

EL5LVICA

5" Low Voltage IC, airtight housing
 Height: 7 1/2" - Ceiling Opening: 5 1/2"
 Lamp: 50W MR16

NEW!

- Double wall IC housing with thermal protector. • For use in insulated ceilings. Supplied with captive bar hangers for 24" joist spacing.

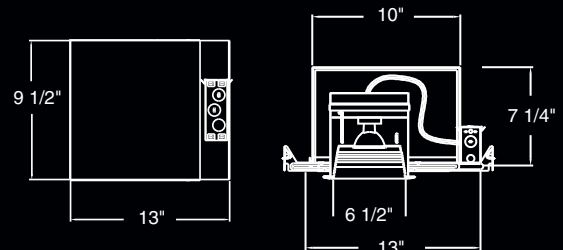

- Magnetic 50W Transformer included.
- Trim assembly and lamp not included.
- Meets California T24 requirements.
- UL listed damp location.
- UL listed feed through.
- A= ASTM Airtight Fixture



- 7 1/2" height allows for use in 2 x 8 construction.
- Unit slips through 5 1/2" ceiling opening. Integral flange secures fixture against ceiling. Four remodel clips secure housing and accommodate various ceiling thicknesses.
- UL Damp Location.

5" Low Voltage Adjustable Baffle Trims

O.D. : 6 1/4"

O.D. : 7 1/4"

EL 5493B

Adjustable Black Baffle
Lamp: MR16-75W
O.D.: 6 1/4"



EL 5593B

Adjustable Baffle
Lamp: MR16-75W
O.D.: 7 1/4"



EL 5493W

Adjustable White Baffle
Lamp: MR16-75W
O.D.: 6 1/4"



EL 5593W

Adjustable Baffle
Lamp: MR16-75W
O.D.: 7 1/4"



5" Low Voltage Adjustable Reflector Trims

O.D. : 6 1/4"

O.D. : 7 1/4"

EL 5421B

Adjustable Reflector
Lamp: MR16-75W
O.D.: 6 1/4"



EL 5521B

Adjustable
Black Reflector
Lamp: MR16-75W
O.D.: 7 1/4"



EL 5421C

Adjustable Reflector
Lamp: MR16-75W
O.D.: 6 1/4"



EL 5521C

Adjustable
Chrome Reflector
Lamp: MR16-75W
O.D.: 7 1/4"



EL 5421G

Adjustable Reflector
Lamp: MR16-75W
O.D.: 6 1/4"



EL 5521G

Adjustable
Gold Reflector
Lamp: MR16-75W
O.D.: 7 1/4"



EL 5421W

Adjustable Reflector
Lamp: MR16-75W
O.D.: 6 1/4"



EL 5521W

Adjustable
White Reflector
Lamp: MR16-75W
O.D.: 7 1/4"



5" Low Voltage Adjustable Trims



O.D.: 6 1/4"

O.D.: 7 1/4"

EL 5420W
Adjustable Slot
Aperture Trim
Lamp: MR16-75W
O.D.: 6 1/4"



EL 5520W
Adjustable Slot
Aperture Trim
Lamp: MR16-75W
O.D.: 7 1/4"



EL 5488W
Adjustable Spot
Pull Down Trim
Lamp: MR16-75W
O.D.: 6 1/4"



EL 5588W
Adjustable Spot
Pull Down Trim
Lamp: MR16-75W
O.D.: 7 1/4"



EL 5497W
Drop Adjustable Trim
Lamp: MR16-75W
O.D.: 6 1/4"



EL 5597W
Drop Adjustable Trim
Lamp: MR16-75W
O.D.: 7 1/4"



EL 5498W
Adjustable
Eyeball Trim
Lamp: MR16-75W
O.D.: 6 1/4"



EL 5598W
Adjustable
Eyeball Trim
Lamp: MR16-75W
O.D.: 7 1/4"



EL 5434WW
EL 5434WB
Adjustable Gimbal
Ring with Deep Baffle Trim
Lamp: MR16-75W
O.D.: 6 1/4"



EL 5534WW
EL 5534WB
Adjustable Gimbal Ring
with Deep Baffle Trim
Lamp: MR16-75W
O.D.: 7 1/4"



5" Low Voltage Lensed Trims

O.D.: 6 1/4"

EL 5411B
Adjustable
Reflector with
Clear Lens
Lamp: MR16-75W
O.D.: 6 1/4"



EL 5411C
Adjustable
Reflector with
Clear Lens
Lamp: MR16-75W
O.D.: 6 1/4"



EL 5411G
Adjustable
Reflector with
Clear Lens
Lamp: MR16-75W
O.D.: 6 1/4"



EL 5411W
Adjustable
Reflector with
Clear Lens
Lamp: MR16-75W
O.D.: 6 1/4"



EL 5412W
Adjustable
Reflector with
Frosted Lens
Lamp: MR16-75W
O.D.: 6 1/4"



O.D.: 7 1/4"

EL 5511B
Adjustable
Reflector with
Clear Lens
Lamp: MR16-75W
O.D.: 7 1/4"



EL 5511C
Adjustable
Reflector with
Clear Lens
Lamp: MR16-75W
O.D.: 7 1/4"



EL 5511G
Adjustable
Reflector with
Clear Lens
Lamp: MR16-75W
O.D.: 7 1/4"



EL 5511W
Adjustable
Reflector with
Clear Lens
Lamp: MR16-75W
O.D.: 7 1/4"



EL 5512W
Adjustable
Reflector with
Frosted Lens
Lamp: MR16-75W
O.D.: 7 1/4"



5" Accent Color Downlight Trims

O.D. : 6 1/4"

O.D. : 7 1/4"

EL 5452BL
Frosted Blue Glass
Lamp: MR16-75W
O.D.: 6 1/4"



EL 5552BL
Frosted Blue Glass
Lamp: MR16-75W
O.D.: 7 1/4"



EL 5452W
EL 5452R
Frosted Glass
Lamp: MR16-75W
O.D.: 6 1/4"



EL 5552W
EL 5552R
Frosted Glass
Lamp: MR16-75W
O.D.: 7 1/4"



EL 5453BL
Frosted Blue
Stepped Glass
Lamp: MR16-75W
O.D.: 6 1/4"



EL 5553BL
Frosted Blue
Stepped Glass
Lamp: MR16-75W
O.D.: 7 1/4"



EL 5453W
Frosted White
Stepped Glass
Lamp: MR16-75W
O.D.: 6 1/4"



EL 5553W
Frosted White
Stepped Glass
Lamp: MR16-75W
O.D.: 7 1/4"



5" Low Voltage Regressed Adjustable Trims

EL 5610W
EL 5610B
Adjustable Spot Baffle
Lamp: MR16-75W
OD: 6 1/4"



EL 5688W
EL 5688B
Adjustable Spot
Lamp: MR16-75W
OD: 6 1/4"



EL 5611W
EL 5611C
EL 5611G
Adjustable Spot
Reflector
Lamp: MR16-75W
OD: 6 1/4"



EL 5698W
EL 5698B
Eyeball with Baffle
Lamp: MR16-75W
OD: 6 1/4"



5" Low Voltage Retrofit

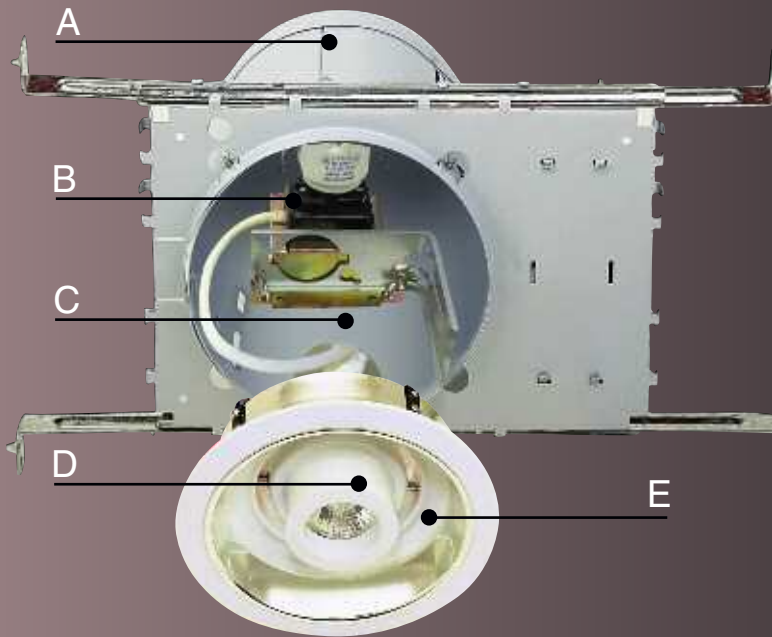

- A** 5" Universal Housing
- B** 12 Volt 50VA Transformer ETRK50
Included, screws into housing's socket
(ETRK50E Electronic Transformer optional)
- C** Socket for MR16 Lamp included with the kit
- D** Low Voltage for Retrofit Trims rated for 20W, 42W, 50W MR16 Lamps (20W Max for IC housings) available in Baffle, Reflector, Eyeball or spot.

ETRK50

Elco's Low Voltage Retrofit Kit permits conversion of existing Line Voltage fixtures to use low voltage MR16 lamps. The Transformer is shipped with the trim assembly and attaches electrically to the medium base socket within the housing. Each trim functions as downlight or adjustable. Housing shown is not included.

Includes Transformer

EL 5110W
EL 5110B
Adjustable Spot Baffle
Lamp: MR16-20W-50W
O.D.: 6 1/4"



EL 5188W
Adjustable
Spot Pull Down
Lamp: MR16-20W-50W
O.D.: 6 1/4"



EL 5111W
EL 5111C
EL 5111G
Adjustable Spot Reflector
Lamp: MR16-20W-50W
O.D.: 6 1/4"



EL 5193W
EL 5193B
Baffle Trim
Lamp: MR16-20W-50W
O.D.: 6 1/4"



EL 5120W
Adjustable Slot
Aperture Trim
Lamp: MR16-20W-50W
O.D.: 6 1/4"



EL 5197W
Drop Adjustable Trim
Lamp: MR16-20W-50W
O.D.: 6 1/4"



EL 5121W
EL 5121B
EL 5121C
EL 5121G
Reflector Trim
Lamp: MR16-20W-50W
O.D.: 6 1/4"



EL 5198W
Adjustable Eyeball
Lamp: MR16-20W-50W
O.D.: 6 1/4"





ELCO Lighting®

We'll communicate

LIGHTING FOR YOU.



"We beat their quality, availability, and of course their price"

Come visit our website at www.elcolighting.com

2042 E. Vernon Ave., Vernon, CA 90058 • TEL 323-231-2600 • FAX 323-231-3200

Elco's Low Voltage Trims



● Pull Down Trim

Metal springs grab inner walls of the housing holding the trim in place.

Snout
(Optional EP300)
Continues the beam and projects a smaller circle of light

Adjusts 0 - 90 degrees

Matching Trim Ring, Baffle & Lamp Holder



Adjustable Deep Baffle Trim



MR16 Ceramic Socket for MR16 lamps.

Pressure Clips

Lamp Holder is the same color as the trim ring.

Gasket

Trim Ring

Deep Baffle
0-30 degrees adjustability

MR16 Ceramic Socket for MR16 lamps.

Pressure Clips

Gasket

Shower Trim



Trim Ring

Tempered glass frosted lens.

Low Voltage Small IC Housing

EL1499ICA

EL1499ICA housing is made smaller to fit in tight places.

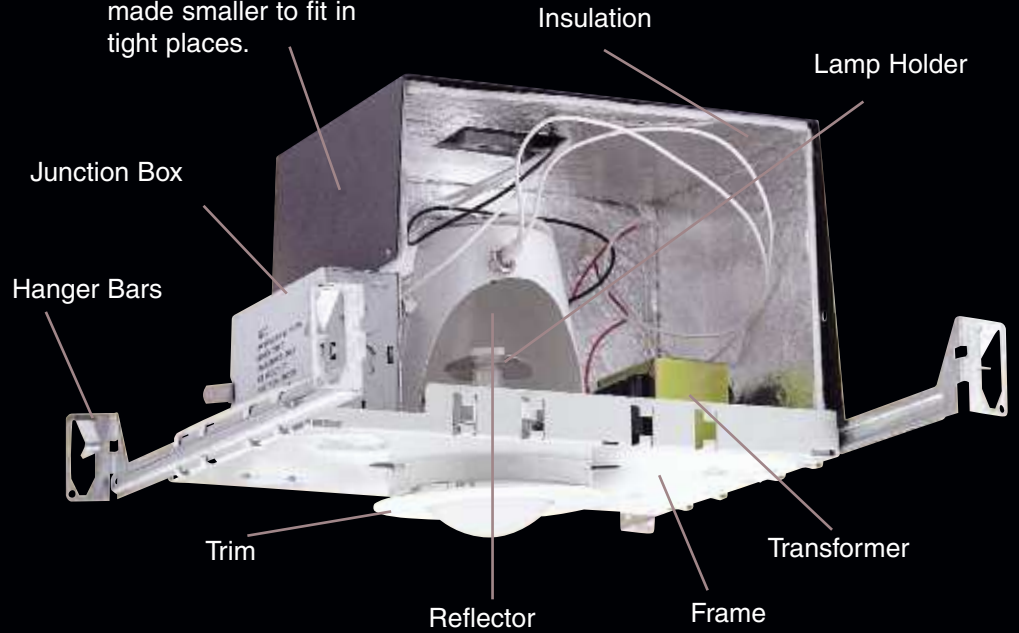
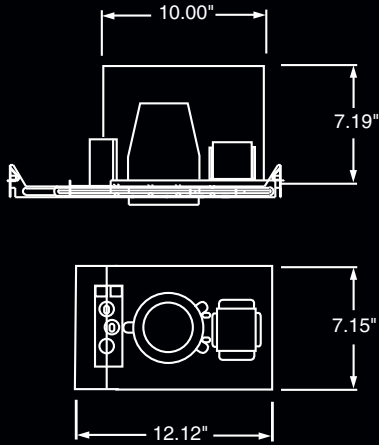

MR16 Ceramic Socket for MR16 lamps

Shower Trim with Frosted Dome Lens EL 1416W



Adjustable Wall Wash Trim EL 1488B

Does not extrude below ceiling.

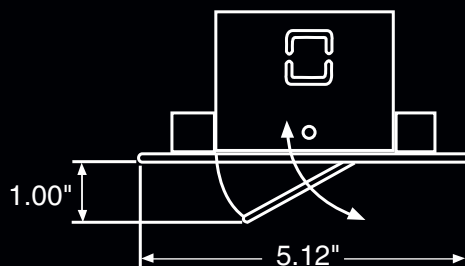

4" LOW VOLTAGE MINIATURE DOWNLIGHT

Junction Box

have extra large 32 cubic inch capacity, and are made of 16 gauge galvanized steel with snap-on covers for easy access from either side.

Lampholder MR16

Universal Use

for residential, commercial or T-Bar ceiling.

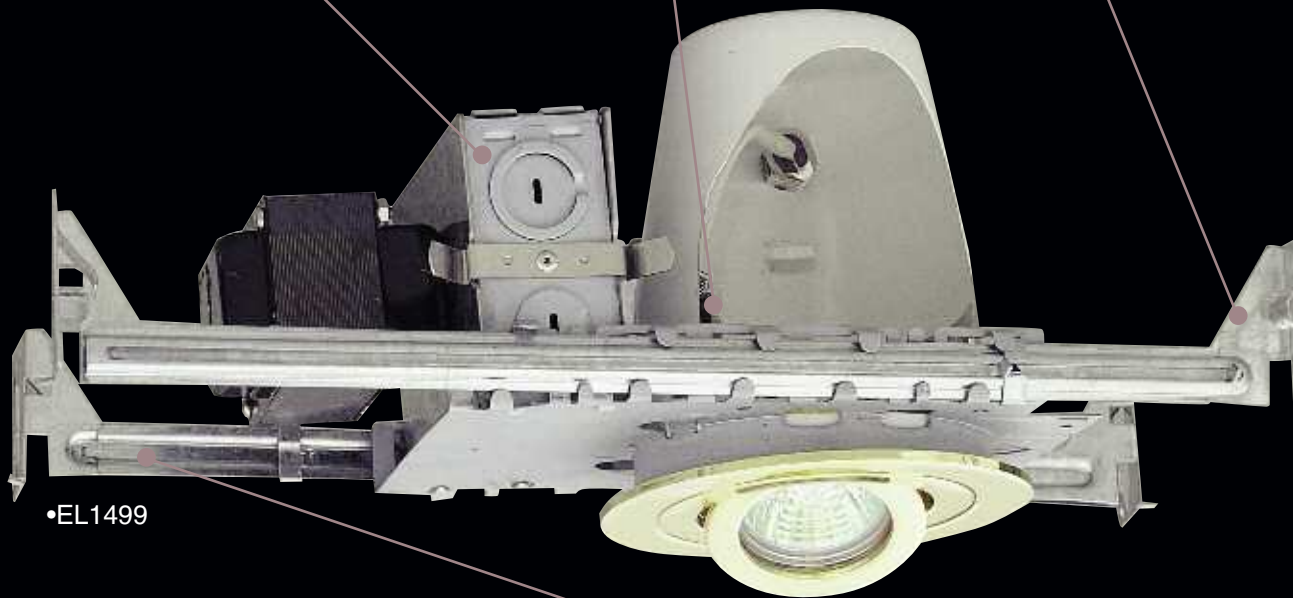

•EL1499

Hanger Bars

are designed with large serrated barbs. Barb edge is sharpened and angled against the wood grain, allowing for nail free installation with maximum grip. Patent pending.

Junction Box

Knockouts for Flex

Romex with Strain Relief and 1/2" Conduit Box (4 in and 4 out) maximum of 8 no. 12 AWG. Quick (Push-in) Connectors on input wires eliminate the need for wire connectors and easy installation.

Romex Cable

4 ROMEX Knockouts with internal strain relief clips for easy installation.

Knockouts
for Romex

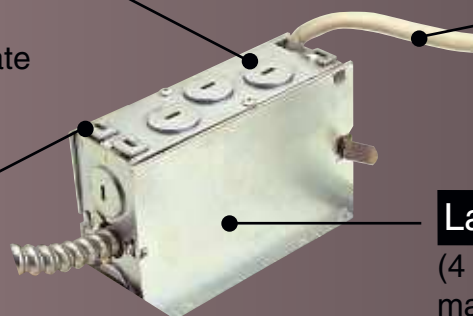

Large Junction Box

(4 in and 4 out)
maximum of 8 no. 12 AWG

Available Trims

Baffle

EL 1493BG

EL 1493BBZ



Pinhole

EL 1423W

EL 1429BC



Slot Aperture

EL 1420G

EL 1420W

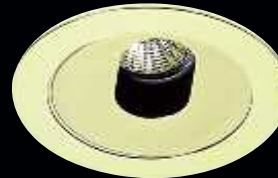

Accent

EL 1452R

EL 1442G



Adjustable

EL 1498WW

EL 1498G



Elco presents 4" Low Voltage 50W and 75W/120V, 277V low voltage downlight housings. At Elco, we use only the highest quality made transformers backed with a three year-warranty. We offer a great variety of fully directional downlight trims for our 4' low voltage housings. They offer a variety of beam spreads to achieve dramatic lighting results. Elco offers quick delivery.

4" Low Voltage Miniature IC Housing

EL1499IC

Low Voltage IC Housing

Height: 7 1/4" - Ceiling Opening: 4 1/4"

Lamp: 12V-50W-MR16

- Small aperture low voltage housing, may be installed in direct contact with ceiling insulation.
- Integral thermal protector
- Integral magnetic transformer steps line voltage down to lamp operating voltage.
- Junction box is listed for through branch circuit wiring has 1/2" knockouts with pryout slots.

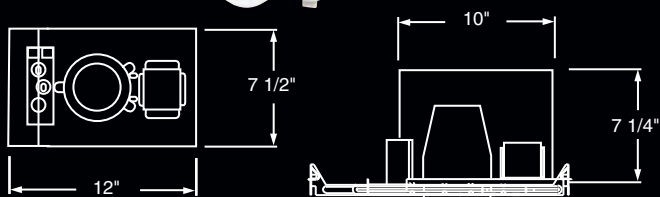

- Captive bar hangers span 24" joists and can be repositioned 90°
- 7 1/4" Height allows for use in 2 x 8 construction.
- Housing adjusts 1 3/8" to accommodate various ceiling thickness.
- U.L. Listed for direct contact with insulation
- Damp Location Listed
- Patent Pending

EL1499ICA, EL1499ICA-277, **NEW!** EL1499ICEA

Low Voltage Housing IC Airtight

Height: 7 1/4" - Ceiling Opening 4 1/4"

Lamp: 12V-50W-MR16

- IC Airtight low voltage housing
- Integral thermal protector
- Integral magnetic transformer steps line voltage down to lamp operating voltage.
- Junction box is listed for through branch circuit wiring has 1/2" knockouts with pryout slots.
- EL1499ICEA includes electronic transformer

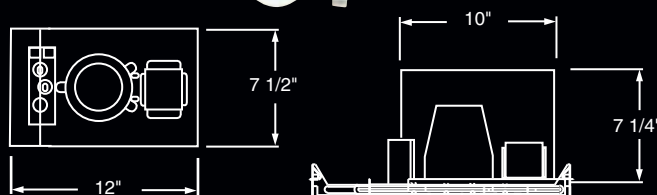

- Captive bar hangers span 24" joists and can be repositioned 90°
- 7 1/4" Height allows for use in 2 x 8 construction.
- Housing adjusts 1 3/8" to accommodate various ceiling thickness.
- U.L. Listed for direct contact with insulation
- Damp Location Listed
- Patent Pending
- A= ASTM Airtight Fixture

4" Low Voltage Miniature Housings

EL1499, EL1499A, EL1499EA, EL1499-277

Low Voltage Housing

Height: 5 1/2" - Ceiling Opening: 4 1/4"

Lamp: 12V-50W-MR16

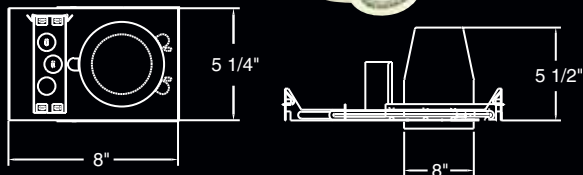

- Housing is a thermally protected.
- Integral thermal protector guards against improper lamping.
- Junction box is listed for through branch circuit wiring and has (six) 1/2" knockouts with true pry-outs slots.
- Captive bar hangers span 24" joists and can be repositioned 90°.
- 5 1/2" height allows for use in 2 x 6 construction..
- Housing adjusts 3/4" to accommodate various ceiling thickness.
- U.L. listed
- A= ASTM Airtight Fixture
- EL1499EA Includes electronic transformer

4" Low Voltage Shallow IC Housing, Airtight

NEW! EL1499ICAS

Low Voltage Housing

Height: 5 1/2" - Ceiling Opening: 4 1/4"

Lamp: 12V-50W-MR16

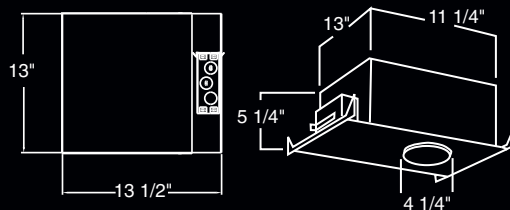

Double wall IC housing with thermal portector. For use in insulated ceilings. Supplied with captive bar hangers for 24" joist spacing. UL listed damp locations.

4" Low Voltage Miniature Housing

EL1499-75, **NEW!** EL1499A-75, EL1499-75-277

Low Voltage Housing

Height: 6 1/2" - Ceiling Opening: 4 1/4"

Lamp: 12V-75W-MR16

- Small aperture low voltage housing
- Integral thermal protector guards against misuse of insulation materials and improper lamping.
- Integral magnetic 75W transformer steps line voltage down to lamp operating voltage.
- Junction box is listed for through branch circuit wiring and has 1/2" knockouts with true pryout slots.

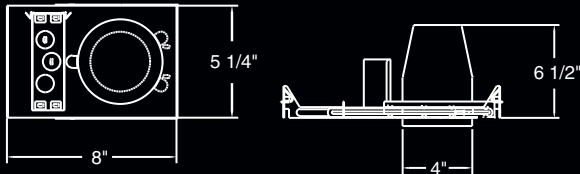

- Captive bar hangers span 24" joists and can be repositioned 90°.
- 6 1/2" height allows for use in 2 x 8 construction.
- Housing can be removed from plater frame for junction box access.
- U.L. Damp Location Listed
- U.L. Feed Through Listed
- A= ASTM Airtight Fixture

EL1499R, **NEW!** EL1499RA, **NEW!** EL1499REA, EL1499R-277

Low Voltage Remodel Housing

Height: 5 1/2" - Ceiling Opening: 4 1/4"

Lamp: 12V50W-MR16

- Small aperture low voltage remodel housing
- Integral thermal protector guards against misuse of insulation materials and improper lamping.
- Integral magnetic transformer steps line voltage down to lamp operating voltage.
- Junction box listed for 90° supply wire.

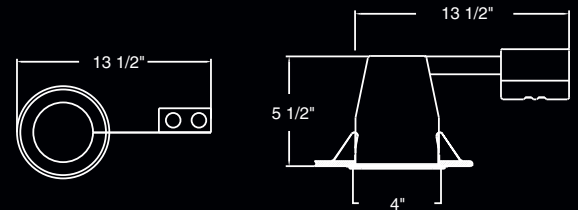

- 5 1/2" height allows use in 2 x 6 construction.
- Unit slips through 4 1/4" opening.
- Integral Flange secures housing against ceiling.
- Four remodel clips secure housing and accommodate various ceiling thickness.
- U.L. Damp Location Listed
- U.L. Feed Through Listed
- A= ASTM Airtight Fixture
- EL1499REA Includes electronic transformer

EL1499R-75, EL1499RA-75 **NEW!**, EL1499R75-27

Low Voltage Remodel Housing

Height: 6 1/2" - Ceiling Opening: 4 1/4"

Lamp: 12V-75W-MR16

- Small aperture low voltage remodel housing
- Integral thermal protector guards against misuse of insulation materials and improper lamping.
- Integral magnetic transformer steps line voltage down to lamp operating voltage.
- Junction box listed for 90° supply wire.

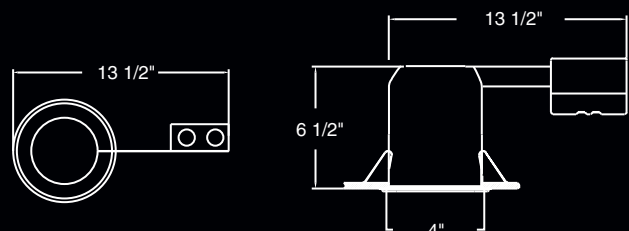

- 6 1/2" height allows use in 2 x 8 construction.
- Unit slips through 4 1/4" opening.
- Integral Flange secures housing against ceiling.
- Four remodel clips secure housing and accommodate various ceiling thickness.
- U.L. Damp Location Listed
- U.L. Feed Through Listed
- A= ASTM Airtight Fixture

4" Low Voltage Miniature Housing (Cont.)

EL1499S

Low Voltage Shallow Housing
 Height: 3 5/8" - Ceiling Opening: 4 1/4"
 Lamp: 12V50W-MR16

NEW!

- Small aperture low voltage shallow housing
- Integral thermal protector guards against misuse of insulation materials and improper lamping.
- Integral magnetic transformer steps line voltage down to lamp operating voltage.
- Junction box listed for 90° supply wire.

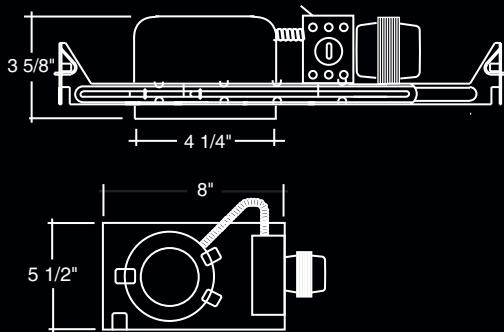

- U.L. Damp Location Listed
- U.L. Feed Through Listed

EL1499RS

Low Voltage Shallow Remodel Housing
 Height: 3 5/8" - Ceiling Opening: 4 1/4"
 Lamp: 12V50W-MR16

NEW!

- Small aperture low voltage remodel housing
- Integral thermal protector guards against misuse of insulation materials and improper lamping.
- Integral magnetic transformer steps line voltage down to lamp operating voltage.
- Junction box listed for 90° supply wire.

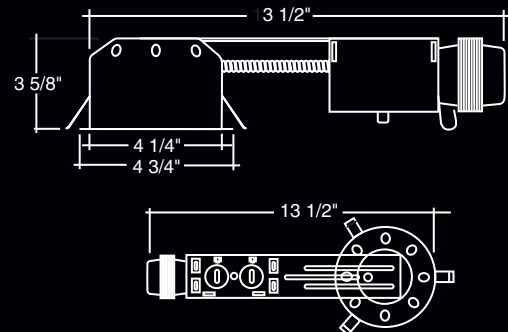

- Unit slips through 4 1/4" opening.
- Integral Flange secures housing against ceiling.
- Three remodel clips secure housing and accommodate various ceiling thickness.
- U.L. Damp Location Listed
- U.L. Feed Through Listed

E400

4" Miniature Halogen Downlight MR16
 Height: 4" Diameter: 4 1/2"

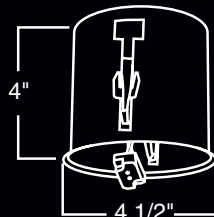

- Thermally protected 4" Housing with MR 16 socket.
- Can be used with most of the 4" Low Voltage trims.
- For use with remote transformer
- Trims not included
- 35 Watt Max
- E.T.L. Listed

E450

4" Miniature Halogen Downlight
 Height: 3 1/2" Diameter: 4"

NEW!

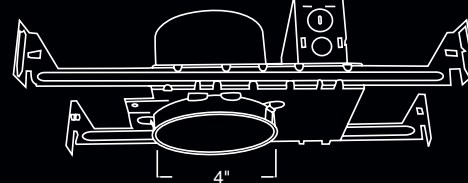

- 4" Housing with MR 16 socket and plaster frame.
- Can be used with all of the 4" Low Voltage trims.
- For use with remote transformer
- Thermally protected
- Includes 24" Captive Bar Hangers
- Can be used in 2 x 4 Joist
- Trims not included
- E.T.L. Listed for 35W Max

4" Low Voltage Lensed Shower Trims

EL 1411W **NEW!**
 EL 1411C
 EL 1411N
 EL 1411SH (with Lexon ring)
 Adjustable Shower
 Trim with Clear Lens
 Lamp: 50W-MR-16
 O.D.: 4 3/4"



EL 1412CP **NEW!**
 Adjustable Shower
 Trim with Diffused Lens
 Lamp: MR16-20W-50W
 O.D.: 4 3/4"



EL 1411BZ **NEW!**
 Adjustable Shower
 Trim with Clear Lens
 Lamp: MR16-50W
 O.D.: 4 3/4"



EL 1415G **NEW!**
 EL 1415B
 EL 1415C
 EL 1415N
 EL 1415W
 EL 1415SH (with Lexon ring)
 Adjustable Shower Trim with
 Frosted Pinhole Lens
 Lamp: 50W-MR16
 O.D.: 4 3/4"



EL 1411CP **NEW!**
 Adjustable Shower
 Trim with Clear Lens
 Lamp: MR16-50W
 O.D.: 4 3/4"



EL 1415BZ **NEW!**
 Adjustable Shower Trim
 with Frosted Pinhole Lens
 Lamp: MR16-20W-50W
 O.D.: 4 3/4"



EL 1412W **NEW!**
 EL 1412B
 EL 1412C
 EL 1412N
 EL 1412SH (with Lexon ring)
 Adjustable Shower
 Trim with Diffused Lens
 Lamp: 50W-MR16
 O.D.: 4 3/4"



EL 1415CP **NEW!**
 Shower Trim
 with Frosted
 (Clear on center Glass)
 Lamp: MR16-20W-50W
 O.D.: 4 3/4"



EL 1412BZ **NEW!**
 Adjustable Shower
 Trim with Diffused Lens
 Lamp: MR16-20W-50W
 O.D.: 4 3/4"



EL 1416W
 Shower Trim with
 Round Drop Frosted Lens
 Lamp: MR16-20W-50W
 O.D.: 4 7/8"



4" Low Voltage Baffle Trims

EL 1493CP **NEW!**
Adjustable
Baffle Trim, All Copper
Lamp: MR16-75W
O.D.: 4 3/4"



EL 1493N
Metal Baffle Trim
Lamp: 75W-MR-16
O.D.: 4 3/4"



EL 1493BCP **NEW!**
Black Phenolic Baffle
with Copper Ring
Lamp: MR16-75W
O.D.: 4 3/4"



EL 1493W
EL 1493WN
Phenolic Baffle Trim
Lamp: 75W-MR16
O.D.: 4 3/4"



EL 1493BZ **NEW!**
Adjustable Baffle
Trim, All Bronze
25° Angle
Lamp: MR16-75W
O.D.: 4 3/4"



EL 1493DW
EL 1493DB
Phenolic Baffle
with Diecast Trim Ring
Lamp: 75W-MR16
O.D.: 4 3/4"



EL 1493BN
EL 1493B
EL 1493BB
Phenolic Baffle Trim
Lamp: 75W-MR16
O.D.: 4 3/4"



EL 1493MB **NEW!**
EL 1493MW
Adjustable
Metal Baffle
Lamp: MR16
20 - 42 - 50W
O.D.: 4 3/4"



EL 1493BBZ **NEW!**
Black Phenolic
Deep Baffle with
Bronze Ring
Lamp: MR16-75W
O.D.: 4 3/4"



EL 1494BG
EL 1494B
EL 1494BN
Black Phenolic
Deep Baffle
Lamp: 75W-MR16
O.D.: 4 3/4"



EL 1493WBZ **NEW!**
Phenolic White Baffle
with Bronze Ring
25° Angle
Lamp: MR16-75W
O.D.: 4 3/4"



EL 1493BG
EL 1493BC
Black Baffle with
Gold or Chrome Ring
Lamp: 20-42-50-75W-MR16
O.D.: 4 3/4"



EL 1494WN
EL 1494W
White Phenolic
Deep Baffle Trim
Lamp: 75W-MR16
O.D.: 4 3/4"



4" Low Voltage Adjustable Trims

EL 1418W

Drop Adjustable
Ring: 0° - 90° Tilt
Lamp: MR16
20 - 42 - 50 - 75W
O.D.: 4 3/4"



EL 1421CP

Adjustable
Specular Reflector
Trim with Copper Ring
Lamp: MR16-20-75W
O.D.: 4 3/4"

NEW!



EL 1419W

EL 1419B

Pinhole
Lamp: MR16
20 - 42 - 50W
Pinhole: 2" aperture
O.D.: 4 3/4"



EL 1421CN

EL 1421BN

EL 1421CC

EL 1421GG

EL 1421GN

EL 1421WN

Chrome Reflector
with Chrome Trim
Ring or Gold Reflector
with Gold Trim Ring
Lamp: MR16
20 - 42 - 50 - 75W
O.D.: 4 3/4"



EL 1420BZ

NEW!

Adjustable Slot
Aperture Trim
1 3/8" x 2 1/4" Slot
Lamp: MR16 20-50W
O.D.: 4 3/4"

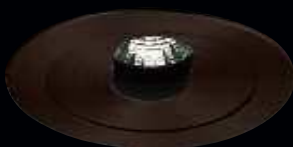

EL 1420CP

NEW!

Adjustable Slot
Aperture Trim
1 3/8" x 2 1/4" Slot
Lamp: MR16 20-50W
O.D.: 4 3/4"



EL 1421CCP

NEW!

Adjustable Clear
Specular Reflector
with Copper Ring
Lamp: MR16-20-75W
O.D.: 4 3/4"



EL 1420N

EL 1420B

EL 1420G

EL 1420W

Slot Aperture
1 3/8" x 2 1/4" Slot
Lamp: MR16
20 - 42 - 50 - 75W
O.D.: 4 3/4"



EL 1421WBZ

NEW!

Adjustable White
Specular Reflector
with Bronze Ring
Lamp: MR16-20-75W
O.D.: 4 3/4"



EL 1421G

EL 1421C

EL 1421W

EL 1421B

Adjustable Specular
Reflector
Lamp: MR16
20 - 42 - 50 - 75W
O.D.: 4 3/4"



EL 1421GCP

NEW!

Adjustable Specular
Gold Reflector Trim
with Copper Ring
Lamp: MR16-20-75W
O.D.: 4 3/4"



EL 1421BZ

NEW!

Adjustable
Specular Reflector
Trim with Bronze Ring
Lamp: MR16-20-75W
O.D.: 4 3/4"



EL 1421GBZ

NEW!

Adjustable
Gold Reflector
with Copper Ring
Lamp: MR16-20-75W
O.D.: 4 3/4"



4" Low Voltage Adjustable Trims (Cont.)

NEW!
 EL 1421WCP
 Adjustable White
 Specular Reflector
 Trim with Copper Ring
 Lamp: MR16-12V 20-75W
 O.D.: 4 3/4"



EL 1424B
 EL 1424N
 EL 1424W
 45° Adjustable
 Wall Wash Baffle Trim
 Lamp: MR20 20-50W
 O.D.: 4 3/4"



EL 1421DG
 EL 1421DC
 Specular Gold or
 Chrome Reflector
 with Diecast Trim Ring
 Lamp: MR16
 20 - 42 - 50 - 75W
 O.D.: 4 3/4"



NEW!
 EL 1424BZ
 45° Adjustable
 Wall Wash Baffle Trim
 Lamp: MR20 20-50W
 O.D.: 4 3/4"



NEW!
 EL 1422BZ
 Adjustable
 Specular Reflector
 Trim with Bronze Ring
 Lamp: MR16-20-75W
 O.D.: 4 3/4"



NEW!
 EL 1424CP
 45° Adjustable
 Wall Wash Baffle Trim
 Lamp: MR20 20-50W
 O.D.: 4 3/4"

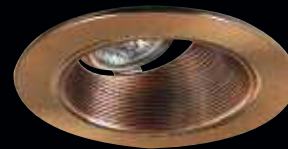

EL 1422C
 EL 1422B
 EL 1422W
 45° Adjustable
 Wall Wash with
 Chrome Reflector Trim
 Rotates 359°
 Lamp: MR16
 20 - 42 - 50 - 75W
 O.D.: 4 3/4"



EL 1425B
 Adjustable Spot
 Lamp: MR16 - 75
 20 - 42 - 50 - 75W
 O.D.: 4 3/4"



NEW!
 EL 1422CP
 45° Adjustable Wall
 Wash Reflector Trim
 Rotate 350°
 Lamp: MR16 20-50W
 O.D.: 4 3/4"



EL 1425W
 EL 1425WN
 EL 1425N
 Adjustable Spot
 Lamp: MR16 - 75W
 O.D.: 4 3/4"



4" Low Voltage Adjustable Trims (Cont.)

EL 1426B
 EL 1426C
 EL 1426G
 EL 1426N
 EL 1426W
 Reflector with
 Suspended Frosted Glass
 Lamp: MR16 20-50W
 O.D.: 4 7/8"



EL 1433W
 EL 1433B
 Gimbal
 Ring with Baffle
 Lamp: MR16
 20 - 42 - 50 - 75W
 O.D.: 4 3/4"



EL 1426BZ **NEW!**
 Reflector with
 Suspended Frosted
 Glass & Bronze Ring
 Lamp: MR16 20-50W
 O.D.: 4 7/8"



EL 1434WB
 EL 1434WW
 Gimbal Ring
 with Deep Baffle
 Lamp: MR16 - 75W
 O.D.: 4 3/4"



EL 1426CP **NEW!**
 Reflector with
 Suspended Frosted
 Glass & Copper Ring
 Lamp: MR16 20-50W
 O.D.: 4 7/8"



EL 1441W
 Stepped
 Round Diecast Trim
 Lamp: MR16
 20 - 42 - 50 - 75W
 O.D.: 4 3/4"



EL 1431B
 EL 1431W
 Baffle with
 Adjustable
 Cylinder Snoot
 Lamp: MR16
 20 - 42 - 50 - 75W
 O.D.: 4 3/4"



EL 1445C
 EL 1445B
 EL 1445G
 EL 1445W
 Reflector Wall Wash
 Lamp: MR16 - 20 - 50W
 O.D.: 4 3/4"



EL 1431BBG
 Black Baffle with
 Adjustable Cylinder
 Snoot and Gold Ring
 Lamp: MR16
 20 - 42 - 50 - 75W
 O.D.: 4 3/4"



EL 1448B
 EL 1448W
 Regressed Eyeball
 Lamp: MR16 - 75W
 O.D.: 4 3/4"



4" Low Voltage Adjustable Trims (Cont.)

EL 1448BG

Regressed Eyeball
Lamp: MR16 - 75W
O.D.: 4 3/4"



EL 1487W

EL 1487B

EL 1487G

EL 1487N

Adjustable Pull Down
with Directional Snoot
Adjusts 85°, Rotates 359°
Lamp: MR16
20 - 50 - 75W
O.D.: 4 3/4"



EL 1488BZ

Diecast
Adjustable Spot Trim
30° Angle
Lamp: MR16 20-50W
O.D.: 4 3/4"

NEW!



EL 1488G

EL 1488N

EL 1488W

Adjustable Spot Trim
Angle: 30°
Lamp: MR16
20 - 42 - 50 - 75W
O.D.: 4 3/4"



EL 1488CP

Diecast
Adjustable Spot Trm
Trim: 30° Angle
Lamp: MR16 20-75W
O.D.: 4 3/4"

NEW!



EL 1488B

Adjustable Spot
Trim: 30° Angle
Lamp: MR16
20 - 42 - 50 - 75W
O.D.: 4 3/4"



EL 1488SB

EL 1488SW
Adjustable
Spot with Special
Clip and Socket
Trim: 30° Angle
Lamp: MR16
20 - 42 - 50 - 75W
O.D.: 4 3/4"

NEW!



EL 1495B

Phenolic
Baffle Wall Wash
Lamp: MR16
20 - 42 - 50W
O.D.: 4 3/4"



EL 1495W

Phenolic
Baffle Wall Wash
Lamp: MR16
20 - 42 - 50W
O.D.: 4 3/4"



EL 1496W

Adjustable
Mirror Tilt Trim
Tilt: 0° - 90°
Lamp: MR16 - 50W
O.D.: 4 3/4"



EL 1497BZ

Adjustable
Pull Down
Tilt: 0° - 90°
Rotates 359°
Lamp: MR16 - 75W
O.D.: 4 3/4"

NEW!



EL 1497CP

Adjustable
Pull Down
Tilt: 0° - 89°
Rotates 359°
Lamp: MR16 - 75W
O.D.: 4 3/4"

NEW!



EL 1497B

Adjustable Pull Down
Tilt: 0° - 90°
Rotates 359°
Lamp: MR16 - 75W
O.D.: 4 3/4"



4" Low Voltage Adjustable Trims (Cont.)

EL 1497G

Adjustable
Pull Down
Tilt: 0° - 90°
Rotates 359°
Lamp: MR16 - 75W
O.D.: 4 3/4"



EL 1498G

Adjustable Eyeball
1 3/8" x 2 1/4" Slot
Lamp: MR16
20 - 42 - 50 - 75W
O.D.: 4 3/4"



EL 1497W

EL 1497N

Adjustable
Pull Down
Tilt: 0° - 90°
Rotates 359°
Lamp: MR16 - 75W
O.D.: 4 3/4"



EL 1498W

Adjustable Eyeball
Lamp: MR16 - 75W
O.D.: 4 3/4"



EL 1498B

Adjustable Eyeball
Lamp: MR16 - 75W
O.D.: 4 3/4"



EL 1498WW

Adjustable Eyeball
Lamp: MR16 - 75W
O.D.: 4 3/4"



4" Low Voltage Square Trims

EL 2412BZ

EL 2412W

Adjustable Shower
Trim with Frosted Lens
Lamp: 50W-MR16
O.D.: 4 3/4"

NEW!



EL 2440W

EL 2440B

EL 2440BZ

Gimbal Ring
with Baffle
Lamp: 50W-MR16
O.D.: 4 3/4"

NEW!



EL 2415BZ

EL 2415W

Adjustable Shower Trim
with Frosted Pinhole Lens
Lamp: 50W-MR16
O.D.: 4 3/4"

NEW!



EL 2421W

EL 2421B

EL 2421C

EL 2421G

EL 2421BZ

EL 2421WBZ

Adjustable Specular
Reflector Trim
Lamp: MR16
20 - 42 - 50 - 75W
O.D.: 4 3/4"

NEW!



EL 2493W

EL 2493B

EL 2493BB

EL 2493BZ

EL 2493BBZ

EL 2493WBZ

Phenolic Baffle Trim
Lamp: 75W-MR16
O.D.: 4 3/4"

NEW!



4" Adjustable Pinhole Trims

EL 1423W
 EL 1423WN
 EL 1423B
 EL 1423BN
 Adjustable
 Pinhole with Baffle
 1 7/8" Aperture
 Lamp: MR16
 20 - 42 - 50W
 O.D.: 4 3/4"



EL 1429B
 EL 1429C
 EL 1429G
 EL 1429N
 EL 1429W
 Adjustable
 Pinhole with Reflector
 1 7/8" Aperture
 Lamp: MR16
 20 - 42 - 50W
 O.D.: 4 3/4"

NEW!



EL 1423WCP
 Pinhole White Baffle
 with Copper Ring
 Lamp: MR16-75W
 O.D.: 4 3/4"

NEW!



EL 1423CP
 Adjustable Copper
 Pinhole with Copper Baffle
 1 7/8" Aperture
 Lamp: MR16 20-50W
 O.D.: 4 3/4"

NEW!



EL 1423BZ
 Adjustable Bronze
 Pinhole with Bronze Baffle
 1 7/8" Aperture
 Lamp: MR16 20-50W
 O.D.: 4 3/4"

NEW!



EL 1429BCP
 Adjustable Pinhole
 with Black Reflector
 1 7/8" Aperture
 Lamp: MR16 20-50W
 O.D.: 4 3/4"

NEW!

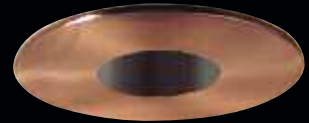

EL 1430N
 EL 1430W
 Adjustable Slot
 Aperture Trim
 One-Piece
 Lamp: MR16 - 75W
 O.D.: 4 3/4"



4" Adjustable Accent Frosted Trims

EL 1442G
 EL 1442W
 Accent Trim with
 Gold or White Ring
 Lamp: MR16
 20 - 42 - 50 - 75W
 O.D.: 4 3/4"



EL 1452R
 Pink Frosted
 Glass Trim
 Lamp: MR16, 20- 75W
 O.D.: 4 3/4"



EL 1452W
 EL 1452BL
 Frosted Glass Trim
 Lamp: MR16
 20 - 42 - 50 - 75W
 O.D.: 4 3/4"



EL 1453BL
 EL 1453W
 Blue Frosted
 Stepped Glass Trim
 Lamp: MR16, 20- 75W
 O.D.: 4 3/4"



4" Low Voltage Sloped Ceiling Trims

EL 1421C
 EL 1421B
 EL 1421G
 EL 1421W
 Specular
 Clear Reflector
 Lamp: MR16, 20- 75W
 O.D.: 4 3/4"



EL 1488G
 EL 1488W
 Adjustable Spot Trim
 Angle: 30°
 Lamp: MR16, 20- 75W
 O.D.: 4 3/4"

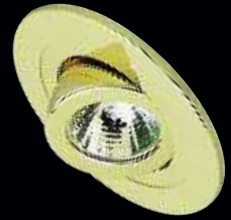

EL 1425B
 Adjustable Spot
 Lamp: MR16, 20- 75W
 O.D.: 4 3/4"

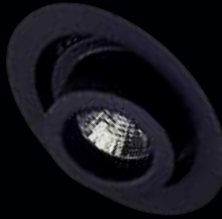

EL 1488B
 EL 1488N
 Adjustable Spot Trim
 Angle: 30°
 Lamp: MR16, 20- 75W
 O.D.: 4 3/4"

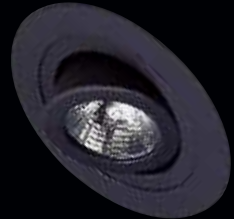

EL 1425W
 Adjustable Spot
 Lamp: MR16, 20- 75W
 O.D.: 4 3/4"

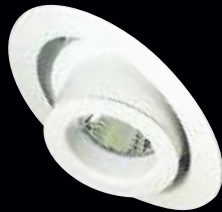

EL 1498BB
 Adjustable Eyeball
 Lamp: MR16, 20- 50W
 O.D.: 4 3/4"

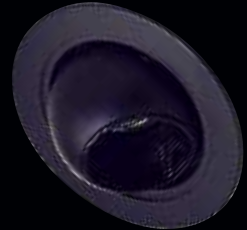

EL 1448G
 Baffle with
 Regressed Eyeball
 Lamp: MR16, 20- 75W
 O.D.: 4 3/4"

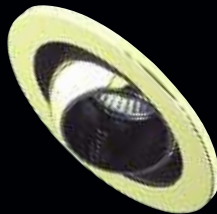

EL 1497W
 EL 1497N
 Drop Adjustable Ring
 Tilt: 0°-90°
 O.D.: 4 3/4"



EL 1448W
 Baffle with
 Regressed Eyeball
 Lamp: MR16, 20- 75W
 O.D.: 4 3/4"



EL 1498W
 Eyeball
 Lamp: MR16, 20- 50W
 O.D.: 4 3/4"



EL 1448B
 Baffle with
 Regressed Eyeball
 Lamp: MR16, 20- 75W
 O.D.: 4 3/4"

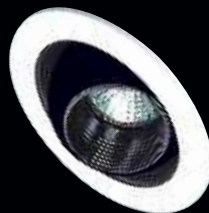

EL 1498WW
 Eyeball
 Lamp: MR16, 20- 50W
 O.D.: 4 3/4"



3" Low Voltage Adjustable Trims

EL2699, EL2699A

EL2699-75, EL2699-277

3" Low Voltage Housing

Opening: 3 5/8" - Height: 4 7/8" , 6 1/4" (75W unit)

Cutout Hole Size: 3 3/4"

- 3" Low Voltage Housing with thermal protector.
- Includes 12V, Magnetic Transformer.
- Hanger bars for 24" joists included.
- Lamp: 12V, MR16 bi-pin (not included)
- UL Listed for damp locations.

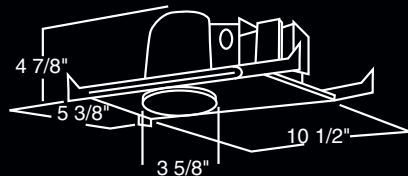

- Cutout Hole Size 3 3/4"
- U.L. Listed for damp locations
- A= ASTM Airtight Fixture

EL2699ICA

3" Low Voltage IC Airtight Housing

Opening: 3 5/8" - Height: 7 1/4" - Ceiling Cutout

Hole Size: 3 3/4"

- 3" Low Voltage IC Airtight Housing with thermal protector.
- Includes 12V, 50W magnetic transformer.
- Hanger bars for 24" joists included.
- May be installed in direct contact with ceiling insulation.
- UL Listed for damp locations.

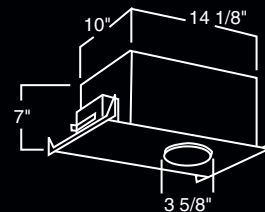

- Lamp: 12V, 50W maximum, MR16 (not included).
- Opening: 3 5/8", Cutout Hole Size: 3 3/4"
- U.L. Listed for damp locations.
- A= ASTM Airtight Fixture

EL2699R, EL2699RA

3" Low Voltage Remodel Housing

Opening: 3 5/8" - Height: 5 3/8"

Cutout Hole Size: 3 3/4"

- 3" Low Voltage Remodel Housing with thermal protector.
- Includes 12V, 50W magnetic transformer.
- Lamp: 12V, MR16 bi-pin (not included)

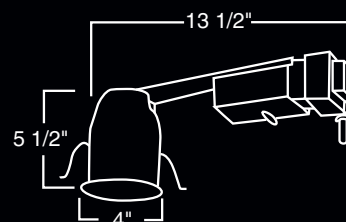
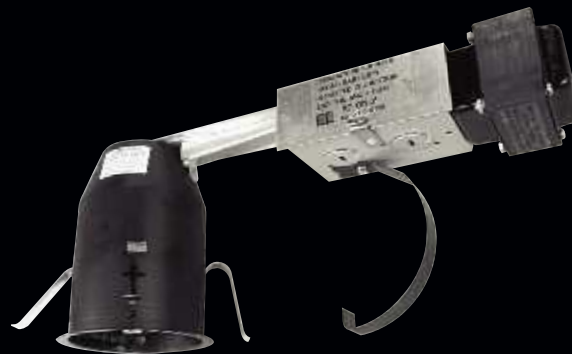

- Opening: 3 5/8"
- Cutout Hole Size: 3 3/4"
- U.L. Listed for damp locations
- A= ASTM Airtight Fixture

3" Low Voltage Adjustable Trims (Cont.)

EL2699S

Low Voltage Shallow Housing
 Height: 3 5/8" - Ceiling Opening: 3 5/8"
 Lamp: 12V50W-MR16

NEW!

- Small aperture low voltage shallow housing
- Integral thermal protector guards against misuse of insulation materials and improper lamping.
- Integral magnetic transformer steps line voltage down to lamp operating voltage.
- Junction box listed for 90° supply wire.

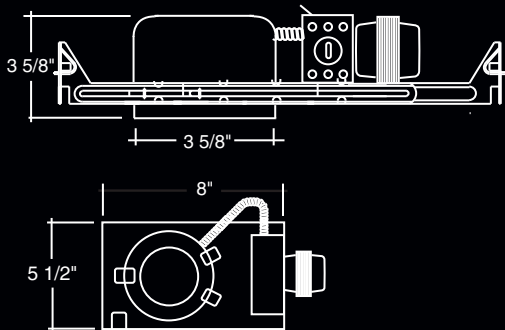

- U.L. Damp Location Listed
- U.L. Feed Through Listed

EL2699RS

Low Voltage Remodel Housing
 Height: 3 5/8" - Ceiling Opening: 3 3/4"
 Lamp: 12V50W-MR16

NEW!

- Small aperture low voltage shallow remodel housing
- Integral thermal protector guards against misuse of insulation materials and improper lamping.
- Integral magnetic transformer steps line voltage down to lamp operating voltage.
- Junction box listed for 90° supply wire.

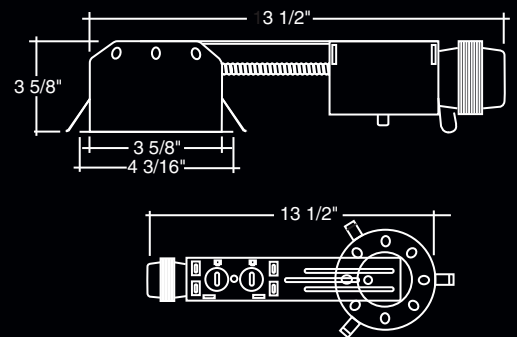

- Unit slips through opening.
- Integral Flange secures housing against ceiling.
- Three remodel clips secure housing and accommodate various ceiling thickness.
- U.L. Damp Location Listed
- U.L. Feed Through Listed



3" Low Voltage Adjustable Trims

EL 2621W
 EL 2621B
 EL 2621C
 EL 2621G
 EL 2621BB
 EL 2621CC
 EL 2621CN
 EL 2621GG
 EL 2621GN
 EL 2621BBZ

NEW!



Die Cast
 Adjustable Reflector
 25° Adjustability
 Lamp: 20W-75W-MR16
 O.D.: 4 1/4"

EL 2621BZ

NEW!



Die Cast
 Adjustable Reflector Trim
 35° Adjustability
 Lamp: 12V/20W-75W/MR16
 O.D.: 4 1/4"

EL 2621CP

NEW!



Die Cast
 Adjustable Reflector Trim
 25° Adjustability
 Lamp: 12V/20W-75W/MR16
 O.D.: 4 1/4"

EL 2622W
 EL 2622B
 EL 2622C
 EL 2622G
 EL 2622N



Die Cast Adjustable
 Wall Wash Reflector
 45° Adjustability
 Lamp: 20W-75W-MR16
 O.D.: 4 5/16"

EL 2622CP

Adjustable
 Wall Wash Reflector Trim
 45° Adjustability
 Lamp: 12V/20W-75W/MR16
 O.D.: 4 5/16"



EL 2624N
 EL 2624B
 EL 2624W

NEW!



Adjustable
 Wall Wash Baffle Trim
 45° Adjustability
 Lamp: 12V/20W-75W/MR16
 O.D.: 4 5/16"

EL 2624CP

NEW!

Die Cast
 Adjustable Reflector Trim
 45° Adjustability
 Lamp: 12V/20W-75W/MR16
 O.D.: 4 5/16"



EL 2644B

EL 2644C

EL 2644G

EL 2644W

Reflector with
 Cross Blade Trim
 45° Adjustability
 Lamp: 12V/20W-75W/MR16
 O.D.: 4 5/16"



EL 2666B

EL 2666G

Fully Retractable
 Die Cast Pull Down Trim
 358° Rotation
 80° Adjustability
 Lamp: 20W-75W-GY6.35 Bi-Pin
 O.D.: 4 1/4"



EL 2666W

EL 2666C

Fully Retractable
 Die Cast Pull Down Trim
 358° Rotation
 80° Adjustability
 Lamp: 20W-75W-GY6.35 Bi-Pin
 O.D.: 4 1/4"



EL 2677G

EL 2677B

EL 2677C

EL 2677W

Fully Retractable
 Die Cast Pull Down
 MR16 Trim
 358° Rotation
 80° Adjustability
 Lamp: 12V/20W-75W MR16
 O.D.: 4 1/4"



EL 2688N

Die Cast
 Adjustable Spot Trim
 35° Adjustability
 358° Rotation
 Lamp: 20W-75W-MR16
 O.D.: 4 1/4"



3" Low Voltage Adjustable Trims (Cont.)

EL 2688BZ **NEW!**
 Die Cast
 Adjustable Spot Trim
 35° Adjustability
 358° Rotation
 Lamp: 12V/20W-75W/MR16
 O.D.: 4 1/4"



EL 2693BZ **NEW!**
 Die Cast
 Adjustable White
 Bronze Baffle Trim with
 Bronze Ring
 35° Adjustability
 Lamp: 12V/20W-75W/MR16
 O.D.: 4 1/4"



EL 2688CP **NEW!**
 Die Cast
 Adjustable Spot Trim
 35° Adjustability
 358° Rotation
 Lamp: 12V/20W-75W/MR16
 O.D.: 4 1/4"



EL 2693CP **NEW!**
 Die Cast Adjustable Copper
 Baffle Trim with Copper Ring
 35° Adjustability
 Lamp: 12V/20W-75W/MR16
 O.D.: 4 1/4"



EL 2688W
 EL 2688B
 EL 2688C
 EL 2688G
 Die Cast
 Adjustable Trim
 35° Adjustability
 358° Rotation
 Lamp: 20W-75W-MR16
 O.D.: 4 1/4"



EL 2693WCP **NEW!**
 Die Cast
 Adjustable White
 Baffle Trim with Copper Ring
 35° Adjustability
 Lamp: 12V/20W-75W/MR16
 O.D.: 4 1/4"



EL 2689WW
 EL 2689WB
 EL 2689BB
 EL 2689W
 Die Cast
 Adjustable Deep Baffle
 25° Adjustability
 358° Rotation
 Lamp: 20W-75W-MR16
 O.D.: 4 1/4"



EL 2693WBZ **NEW!**
 Die Cast
 Adjustable White
 Baffle Trim with Bronze Ring
 35° Adjustability
 Lamp: 12V/20W-75W/MR16
 O.D.: 4 1/4"



EL 2693BN
 EL 2693WN
 EL 2693N
 Die Cast
 Adjustable Baffle Trim
 25° Adjustability
 Lamp: 20W-75W-MR16
 O.D.: 4 1/4"



EL 2695W
 Adjustable Wall Wash
 Scoop with Baffle
 Lamp: 12V/20W-75W/MR16
 O.D.: 4 5/16"



EL 2693W
 EL 2693B
 EL 2693BB
 Die Cast
 Adjustable Baffle Trim
 35° Adjustability
 Lamp: 20W-75W-MR16
 O.D.: 4 1/4"



EL 2696W
 Adjustable Pull Down Trim
 90° Adjustability
 Lamp: 12V/20W-75W/MR16
 O.D.: 4 5/16"



EL 2697CP **NEW!**
 Die Cast
 Pull Down Trim
 87° Adjustability
 358° Rotation
 Lamp: 12V/20W-75W/MR16
 O.D.: 4 1/4"



3" Low Voltage Adjustable Trims (Cont.)

EL 2697BZ

Die Cast
Pull Down
Trim 87° Adjustability
358° Rotation
Lamp: 12V/20W-75W/MR16
O.D.: 4 1/4"

NEW!



EL 2697W

EL 2697B
Die Cast
Pull Down Trim
87° Adjustability
358° Rotation
Lamp: 20W-75W-MR16
O.D.: 4 1/4"



EL 2697N

Die Cast
Pull Down Trim
87° Adjustability
358° Rotation
Lamp: 20W-75W-MR16
O.D.: 4 1/4"



EL 2698WW

EL 2698WB
Die Cast
Adjustable Eyeball Trim
Lamp: 20W-75W-MR16
O.D.: 4 1/4"



3" Shower Trims

EL 2612W

Die Cast Lensed Trim
with Diffused Glass Lens
Lamp: 20W-75W-MR16
O.D.: 4 1/4"



EL 2616C

EL 2616B
EL 2616G
EL 2616W
Die Cast Shower Trim
with Dome Glass Lens
Lamp: 12V, 20W-75W-MR16
O.D.: 4 1/4"



EL 2613W

Die Cast Lensed Trim
Lamp: 12V, 20W-75W MR16
O.D.: 4 1/4"



3" Low Voltage Accent Trims

EL 2619WC

EL 2619WB
Die Cast Pinhole
Trim with Reflector
Lamp: 20W-75W-MR16
Hole: 2" Aperture
O.D.: 4 1/4"



EL 2633W

EL 2633B
Die Cast Louvered Trim
Lamp: 20-75W-MR16
O.D.: 4 1/4"



EL 2620W

Die Cast Slot Aperture Trim
Lamp: 20W-75W-MR16
O.D.: 4 1/4"



EL 2652BL

Die Cast
Round Glass Trim
Lamp: 20-75W-MR16
O.D.: 4 1/4"



3" Low Voltage Accent Trims (Cont.)

EL 2652W

Die Cast
Round Glass Trim
Lamp: 20-75W-MR16
O.D.: 4 1/4"



EL 2653W

Die Cast Accent Trim
Lamp: 20-75W-MR16
O.D.: 4 1/4"



EL 2653BL

Die Cast Accent Trim
Lamp: 20-75W-MR16
O.D.: 4 1/4"



EL 2660W

EL 2660B
EL 2660C
Die Cast Offset
Glass Panel Trim
Lamp: 20-75W-MR16
O.D.: 4 1/4"



3" Low Voltage Sloped Ceiling

EL 2666W

EL 2666B
EL 2666C
EL 2666G
Fully Retractable
Die Cast Pull Down Trim
80° Adjustability
358° Rotation
Lamp: 20-75W GY6.35
O.D.: 4 1/4"



EL 2688CP **NEW!**

Die Cast Adjustable Trim
35° Adjustability
358° Rotation
Lamp: 20-75W-MR16
O.D.: 4 1/4"



EL 2677G

EL 2677B
EL 2677C
EL 2677W
Fully Retractable
Die Cast Pull Down
MR16 Trim
80° Adjustability
358° Rotation
Lamp: 20V/20W-75W-MR16
O.D.: 4 1/4"



EL 2689WW

EL 2689BB
EL 2689WB
Die Cast Adjustable
Regressed Baffle
30° Adjustability
358° Rotation
Lamp: 20-75W-MR16
O.D.: 4 1/4"



EL 2688W

EL 2688B
EL 2688C
EL 2688G
EL 2688N
Die Cast Adjustable Trim
35° Adjustability
358° Rotation
Lamp: 20-75W-MR16
O.D.: 4 1/4"



EL 2697W

EL 2697B
Die Cast Pull Down Trim
87° Adjustability
358° Rotation
Lamp: 20W-75W-MR16
O.D.: 4 1/4"



EL 2688BZ **NEW!**

Die Cast Adjustable Trim
35° Adjustability
358° Rotation
Lamp: 20-75W-MR16
O.D.: 4 1/4"



EL 2698WW

EL 2698WB
Die Cast
Adjustable Eyeball Trim
Lamp: 20W-75W-MR16
O.D.: 4 1/4"



Compact Fluorescent

Compact fluorescent lighting has come a long way in the years since it was first developed. Its immediate benefit still remains its greatest: long-life lamps using a fraction of the energy consumed by incandescent sources. But now the color rendition and available wattage has improved so much that recessed compact fluorescent is often the preferred lumen source at work and at home. Elco Lighting uses fully-warranted name brand American ballasts in their compact fluorescent fixtures. We provide hard-to-find solutions to everyday problems with such products as a dimmable, two-42 watt horizontal 8" remodel fixture designed to eliminate the waste of less energy-efficient PAR lamp alternatives.

Elco Lighting also manufactures emergency fluorescent downlights which provide 90 minutes of uniform emergency illumination using 13W through 42W compact fluorescent lamps. All product specification sheets can be downloaded from our website at www.elcolighting.com

96-144



Description of different dimming ballasts used on compact fluorescent housings:

D

Standard dimming ballast (type D), Advance mark 7 (or equal), 120/277 Intelli-Volt, high power factor, 0-10V DC, 100%-3% dimming range. Requires running 4+ground wires (black, white, ground for line supply and purple and gray wires for 0-10V DC control voltage) from the dimmer switch to the ballast (to be used with compatible dimmer).

DX

Advance Mark 10 (type DX) dimming ballast, 120V, high power factor, 100%-5% dimming range. Requires running 2+ground wires from dimmer switch to the ballast (to be used with compatible dimmer).

DX-7

Advance Mark 10 (type DX-7) dimming ballast, 277V, high power factor, 100%-5% dimming range. Requires running 2+ground wires from dimmer switch to the ballast (to be used with compatible dimmer).

D1

Advance Ambistar (type D1), dimming ballast, 120V, normal power factor, 100%-15% dimming range. Requires running 2+ground wires from dimmer switch to the ballast, can be used with any standard dimmer switch (for best performance use with Advance Mark 10 compatible dimmer).

Lutron type Compact SE Dimming ballasts, 120 or 277V, high power factor, 100%-5% dimming range. Requires running 3+ground wires from dimmer switch to the ballast (to be used with compatible dimmer).

Lutron type 2W Dimming ballasts, 120V, high power factor, 100%-5% dimming range. Requires running 2+ground wires from dimmer switch to the ballast (to be used with compatible dimmer).

8" Architectural Compact Fluorescent IC Housing for 2-26W Lamps

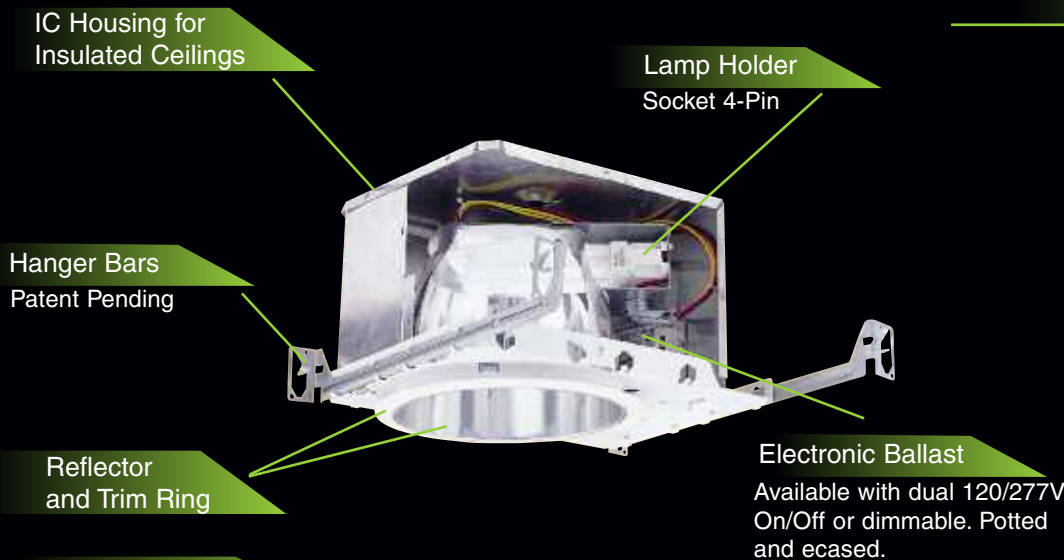

Dimensions

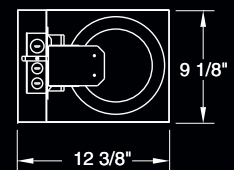
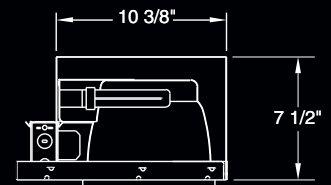

Available Trims

Available in low iridescence clear or gold aluminum finish with polycarbonate trim ring.



Self flanged one piece aluminum reflector



Aluminum Reflector with separate plastic ring.

ELVF Series - Architectural Compact Fluorescent Downlight

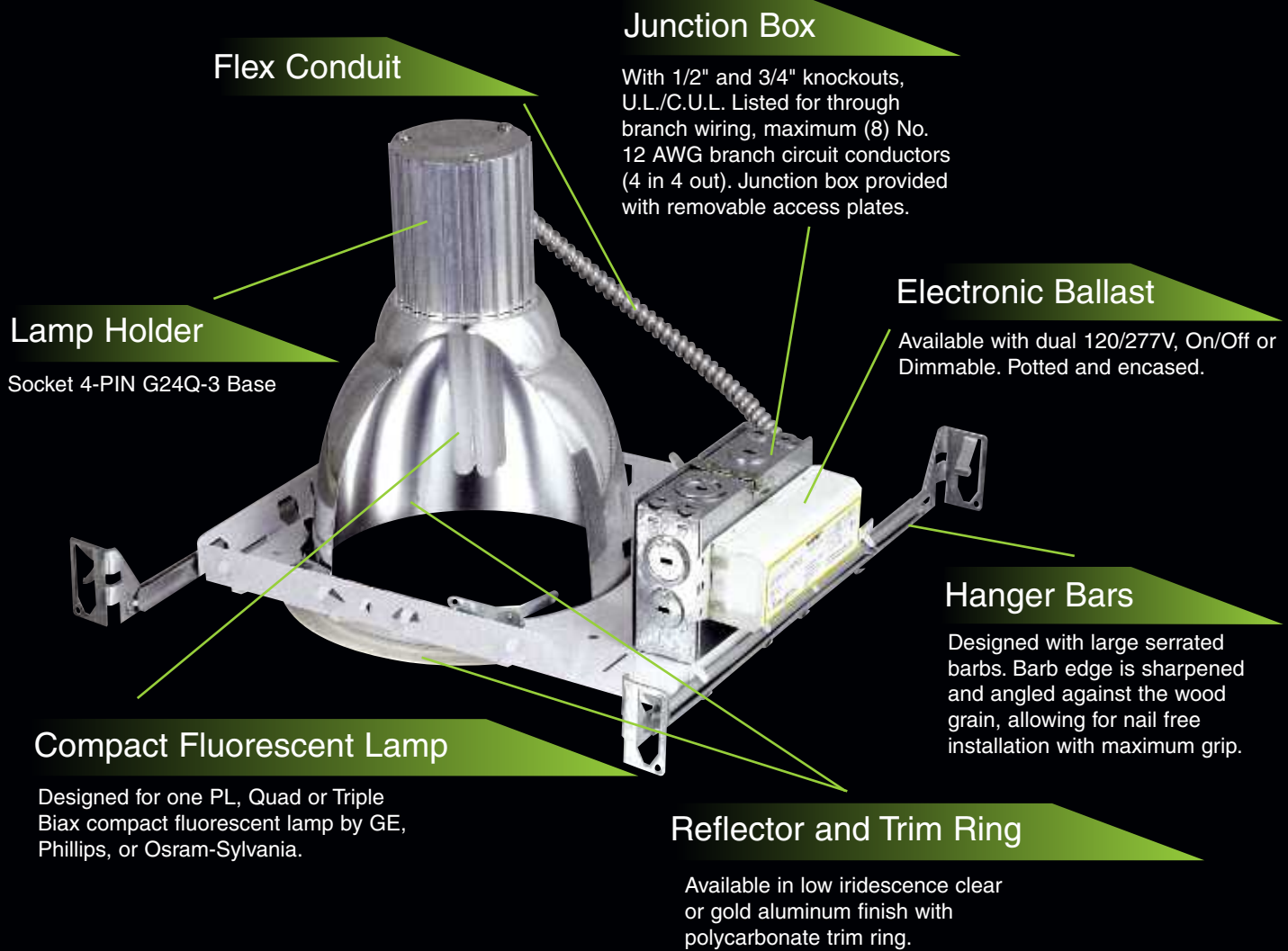

Available Lamps

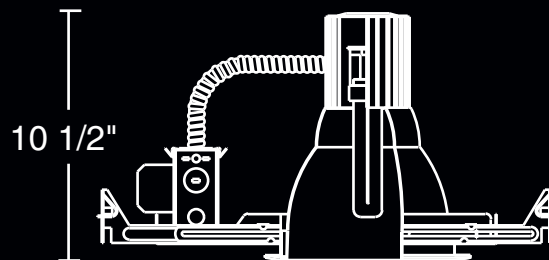
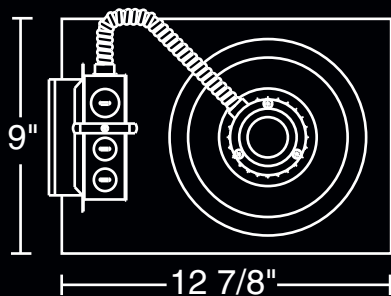

Available Trims

Prismatic Lens Trims EL 832G EL 832W



Baffle Trims EL 833W EL 833B



Reflector Trims EL 816G EL 816C



Prismatic Lens EL 832W EL 832B



Emergency Pack



Available Lamps

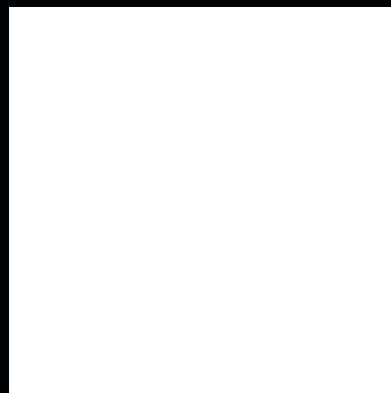

P13-4

P18-4

P26-4

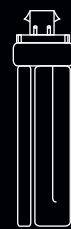

P26T-4

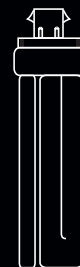

P-32T-4

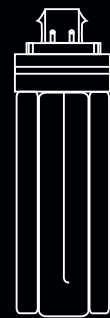

P-42Q-4

8" Architectural Vertical Compact Fluorescent Downlights with Commercial Frame

- Compact fluorescent fixtures designed for single 13, 18, 26W Quad and 13, 18, 26, 32, 42W Triple Compact Fluorescent lamps by GE, Phillips, or Osram-Sylvania.
- Vertacally adjustable mounting brackets accepts 1/2" or C-channels (CH26) or linear bar hangers (FB27), not included.
- Trim support adjusts 3/4" to accommodate different ceiling thickness.
- U.L. damp location listed.
- U.L. feed through listed.
- Energy Efficient



8"

EL 816C, EL 816F, EL 816G

Clear Reflector Trim
Lamp: (1) 42W PL Max
O.D.: 9"



EL 832C, EL 832F, EL 832W

Clear Reflector with lens
Lamp: (1) 42W PL Max
O.D.: 9"



EL 833B, EL 833W

Black or White Baffle with Reflector
Lamp: (1) 42W PL Max
O.D.: 9"



EL 836C, EL 836G

Reflector with Offset Glass
Lamp: (1) 42W PL Max
O.D.: 9"



EL 838C

Clear Wall Wash Reflector trim
Lamp: (1) 42W PL Max.
O.D.: 9"



NEW!

EL 852W, EL 852B

Baffle Reflector with Lens
Lamp: (1) 42W PL Max
O.D.: 9"



Height: 10 1/4"
Ceiling Opening: 8"
Trim O.D.: 9"

ELV 8113
ELV 8113E

(1) 13W 2 Pin PL/Quad 120V N.P.F. Magnetic Ballast
(1) 13W 4 Pin PL Lamp 120/277V Electronic Ballast

ELV 8118
ELV 8118E

(1) 18W 2 Pin Quad 120V N.P.F. Magnetic Ballast
(1) 18W 4 Pin Quad 120/277V Electronic Ballast

ELV 8126

(1) 26W 2 Pin Quad 120V N.P.F. Ballast

ELV 8126E
ELV 8126E-347

(1) 26W 4 Pin Quad or Triple Biax, 120/277V H.P.F. Electronic Ballast
(1) 26W 4 Pin Quad or Triple Biax, 347V H.P.F. Electronic Ballast

NEW!
NEW!
ELV 8126D
ELV 8126DX
ELV 8126DX-7

(1) 26W 4 Pin Quad or Triple Biax, 120/277V Electronic Dimming Ballast
(1) 26W 4 Pin PL-T/26 or Quad 120V Dimmable Ballast, 2 Wires
(1) 26W 4 Pin PL-T/26 or Quad 277V Dimmable Ballast, 2 Wires

ELV 8132E
ELV 8132E-347

(1) 32W 4 Pin Triple Biax, 120V/277V H.P.F. Electronic Ballast
(1) 32W 4 Pin Triple Biax, 347V H.P.F. Electronic Ballast

NEW!
NEW!
ELV 8132D
ELV 8132DX
ELV 8132DX-7

(1) 32W 4 Pin Triple Biax, 120/277V Electronic Dimming Ballast, 4 Wires
(1) 32W 4 Pin Quad 120V Dimmable, 2 Wires
(1) 32W 4 Pin Triple Biax, 277V Electronic Dimming Ballast, 2 Wires

ELV 8142E
ELV 8142E-347

(1) 42W 4 Pin Triple Biax, 120/277V H.P.F. Electronic Ballast
(1) 42W 4 Pin Triple Biax, 347V H.P.F. Electronic Ballast

NEW!
NEW!
ELV 8142D
ELV 8142DX
ELV 8142DX-7

(1) 42W 4 Pin Triple Biax, 120/277V Electronic Dimming Ballast, 4 Wires
(1) 42W 4 Pin Quad 120V Dimmable, 2 Wires
(1) 42W 4 Pin Triple Biax, 277V Electronic Dimming Ballast, 2 Wires

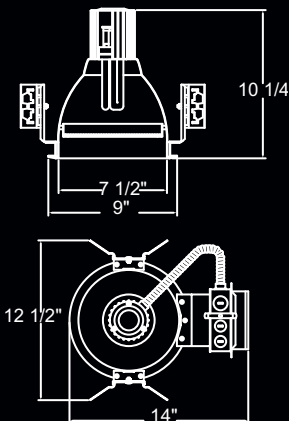

NOTE: 347V Available consult factory

8" Compact Fluorescent Downlight with Plaster Frame

- Compact fluorescent fixtures designed for one vertically mounted compact fluorescent lamp with integral ballast.
- Trim support adjusts 3/4" to accommodate different ceiling thickness.
- Includes 24" captive bar hangers and plaster frame.
- U.L. damp location listed.
- U.L. feed through listed.
- Energy Efficient



8"

EL 816C, EL 816F, EL 816G

Clear Reflector Trim
Lamp: (1) 42W PL Max
O.D.: 9"



EL 832C, EL 832F, EL 832G, EL 832W

Regressed Prismatic Lens
Lamp: (1) 42W PL Max
O.D.: 9"



EL 833W, EL 833B

White or Black Baffle
with Reflector
Lamp: (1) 42W PL Max
O.D.: 9"



EL 836C, EL 836G

Reflector with Offset Glass
Lamp: (1) 42W PL Max
O.D.: 9"



EL 838C

Clear Wall Wash
Reflector trim
Lamp: (1) 42 PL Max.
O.D.: 9"

NEW!



EL 852W, EL 852B

Stepped Baffle with
Regressed Prismatic Lens
Lamp: (1) 42W PL Max
O.D.: 9"



Height: 10 1/4"
Ceiling Opening: 8"
Trim O.D.: 9"

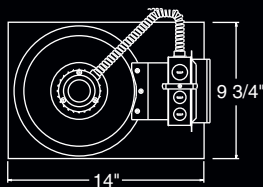
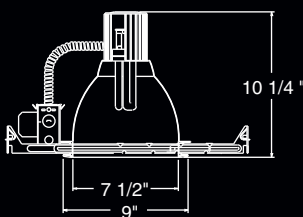

ELVF 813 (1) 13W 2 Pin Twin/Quad Tube 120V Magnetic N.P.F. Ballast
ELVF 813E (1) 13W 4 Pin Quad Tube 120/277V Electronic Ballast

ELVF 818 (1) 18W 2 Pin Quad Tube 120V Magnetic N.P.F. Ballast
ELVF 818E (1) 18W 4 Pin Quad Tube 120/277V Electronic Ballast

ELVF 826 (1) 26W 2 Pin Quad Tube 120V Magnetic N.P.F. Ballast
ELVF 826E (1) 26W 4 Pin Triple Biax or Quad 120/277V Electronic Ballast
ELVF 826D (1) 26W 4 Pin Triple Biax or Quad 120/277V Dimmable Ballast, 4 Wires

ELVF 832E (1) 32W 4 Pin Triple Biax, 120/277V Electronic Ballast
ELVF 832D (1) 32W 4 Pin Triple Biax, 120/277V Dimmable Ballast

ELVF 842E (1) 42W 4 Pin Triple Biax, 120/277V Electronic Ballast
ELVF 842D (1) 42W 4 Pin Triple Biax, 120/277V Dimmable Ballast, 4 Wires

NOTE: 347V Available consult factory

8" Compact Fluorescent Horizontal Downlight with Plaster Frame, IC Rated

- Compact Fluorescent housing with plaster frame, for one or two horizontal mounted lamps with integral electronic ballast for 4 Pin compact fluorescent lamps.
- Trim support adjusts 3/4" to accommodate different ceiling thickness.
- 7 1/4" height allows use in 2 x 8 construction.
- 24" captive hanger bars included.
- U.L. damp location listed.
- Feed through listed.
- U.L. listed for contact with insulation.
- Energy Efficient
- Airtight Housing meet CA Title 24 Requirements (Per ASTM E283)



8"

EL 888C, EL 888G

Reflector with Cross Blades
O.D.: 9"



EL 862C, EL 862G

Clear and Gold Reflector with Lens
O.D.: 9"



EL 821C, EL 821G, EL 821F, EL 821W

Clear Reflector
O.D.: 9"



EL 826C, EL 826G

Suspended Glass Trim with Clear Reflector
O.D.: 9"



EL 830B, EL 830W

Reflector with Baffle
O.D.: 9"



EL 842B, EL 842W

Baffle Trim with Regressed Lens
O.D.: 9"



NEW!

Height: 7 1/4"
Ceiling Opening: 8"
Trim O.D.: 9"

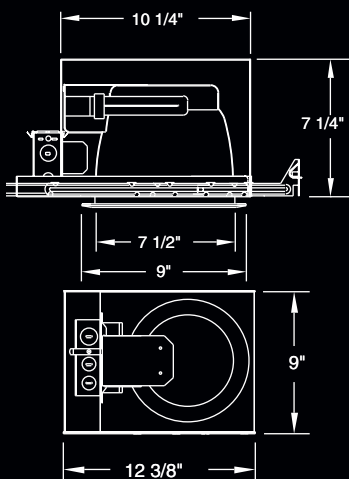

ELH 118ICE (1) 18W 4 Pin Quad 120/277 H.P.F. Electronic Ballast

ELH 126ICE (1) 26W 4 Pin Quad 120/277V H.P.F. Electronic Ballast

ELH 126ICD (1) 26W 4 Pin Quad 120/277V Electronic Ballast Dimmable

ELH 132ICE (1) 32W 4 Pin Triple Biax 120/277V H.P.F. Electronic Ballast

ELH 132ICD (1) 32W 4 Pin Triple Biax 120/277V H.P.F. Electronic Ballast Dimmable

ELH 142ICE (1) 42W 4 Pin Triple Biax 120/277V H.P.F. Electronic Ballast

ELH 142ICD (1) 42W 4 Pin Triple Biax 120/277V H.P.F. Electronic Ballast Dimmable

T24 ELH 142ICEA (1) 42W 4 Pin Triple Biax 120/277V H.P.F. Electronic Ballast, Airtight, CA Title 24

ELH 218ICE (2) 18W 4 Pin Triple Biax, 120/277V H.P.F. Electronic Ballast

ELH 218ICD (2) 18W 4 Pin Triple Biax, 120/277V H.P.F. Electronic Dimmable Ballast

ELH 226ICE (2) 26W 4 Pin Quad 120/277V H.P.F. Electronic Ballast

T24 ELH 226ICEA (2) 26W 4 Pin Quad 120/277V H.P.F. Electronic Ballast, Airtight Housing, CA Title 24

ELH 226ICD (2) 26W 4 Pin Quad 120/277V H.P.F. Electronic Ballast Dimmable

ELH 226ICDX (2) 26W 4 PIN Quad 120 Dimmable with Mark X Ballast. 120V

8" Architectural Horizontal Compact Fluorescent Downlight

- Thermally protected magnetic fixtures are supplied with two single-lamp potted ballast and may be wired for independent switching. Electronic units are supplied with one two-lamp ballast for 4 pin lamps.
- Universal Mounting Bracket accepts 1/2" EMT, C-Channel, T-bar fastener and (CH26 or FB27) hanger bars. Adjustable 5" vertically from above or below ceiling.
- Junction box with 1/2" and 3/4" pryouts, listed for 8 #12 90°C conductors.
- U.L. Listed
- Feed Through Junction Box
- U.L. damp location listed.
- Energy Efficient



8"

EL 888C, EL 888G

Reflector with Cross Blades
O.D.: 9"



EL 862C, EL 862G

Reflector with Lens
O.D.: 9"



EL 821C, EL 821F, EL 821G, EL 821W

Clear Reflector Trim
O.D.: 9"



EL 826C, EL 826G

Suspended Glass Trim with Clear Reflector
O.D.: 9"



EL 830W, EL 830B

Reflector with Baffle
O.D.: 9"



EL 842W, EL 842B

Baffle Regressed Lens
O.D.: 9"



Height: 6 3/8"
Ceiling Opening: 8"
Trim O.D.: 9"

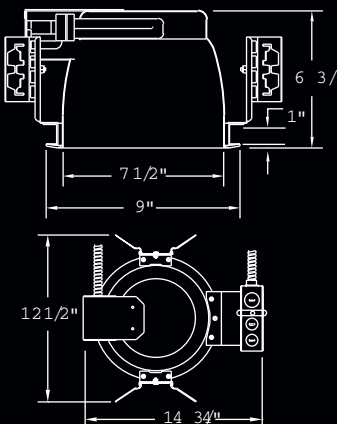

ELH 829 (2) 7W/9W 2 Pin Twin Tube 120V N.P.F. Ballast

ELH 8113 (1) 13W 2 Pin Twin Tube/Quad 120V N.P.F. Ballast

ELH 8213 (2) 13W 2 Pin Twin Tube/Quad 120V N.P.F. Ballast

ELH 8213E (2) 13W 4 Pin Quad 120/277V H.P.F. Electronic Ballast

ELH 8213D (2) 13W 4 Pin Quad 120/277V H.P.F. Electronic Dimming Ballast

ELH 8118 (1) 18W 2 Pin Quad 120V N.P.F. Ballast

ELH 8118E (1) 18W 4 Pin Quad 120/277V Electronic Ballast

ELH 8218 (2) 18W 2 Pin Quad 120V N.P.F. Ballast

ELH 8218E (2) 18W 4 Pin Quad 120/277V H.P.F. Electronic Ballast

ELH 8218D (2) 18W 4 Pin Quad 120/277V H.P.F. Electronic Dimming Ballast, 4 Wires

NEW! ELH 8218DX (2) 18W 4 Pin Quad 120V Dimmable with Mark X Ballast, 2Wires

ELH 8126 (1) 26W Quad 120V N.P.F. Ballast

ELH 8226 (2) 26W 2 Pin Quad 120V N.P.F. Ballast

ELH 8126E (1) 26W 4 Pin Quad 120/277V Electronic Ballast

ELH 8226E (2) 26W 4 Pin Quad 120/277V Electronic Ballast

ELH 8126D (1) 26W 4 Pin Quad 120/277V Dimmable

ELH 8226D (2) 26W 4 Pin Quad 120V/277V Dimmable

NEW! ELH 8226DX (2) 26W 4 Pin Quad 120V Dimmable with Mark X Ballast

ELH 8132E (1) 32W 4 Pin Triple Biax, 120/277V H.P.F. Electronic Ballast

ELH 8132D (1) 32W 4 Pin Triple Biax, 120/277V H.P.F. Electronic Dimmable Ballast

ELH 8142E (1) 42W 4 Pin Triple Biax, 120/277V H.P.F. Electronic Ballast

ELH 8142D (1) 42W 4 Pin Triple Biax, 120/277V H.P.F. Electronic Dimmable Ballast

8" Architectural Electronic Compact Fluorescent Downlight, 2-32W, 2-42W

- Compact fluorescent housing with integral electronic ballast for 4 Pin compact fluorescent lamps.
- Universal Mounting Bracket accepts 1/2" EMT, C-Channel, T-bar fastener and (CH26 or FB27) hanger bars. Adjusts 5" vertically from above or below ceiling.
- Junction box with 1/2" and 3/4" pryouts, listed for 8 #12 90°C conductors.
- Trim support adjusts 3/4" to accommodate different ceiling thickness.
- 6 1/2" height allows use in 2 x 8 construction.
- U.L. listed
- Feed Through Junction Box.
- U.L. damp location listed



8"

EL 889G, EL 889C

Reflector with Cross Blade
O.D.: 9"



EL 882G, EL 882C

Reflector with Lens
O.D.: 9"



EL 827C, EL 827G

Suspended Glass Trim
O.D.: 9"



EL 831B, EL 831W

Baffle with Chrome Reflector
O.D.: 9"



EL 841C, EL 841G, EL 841F, EL 841W

Reflector Trim
O.D.: 9"



EL 843W, EL 843B

Baffle with Regressed Lens
O.D.: 9"



Height: 6 3/8"
Ceiling Opening: 8"
Trim O.D.: 9"

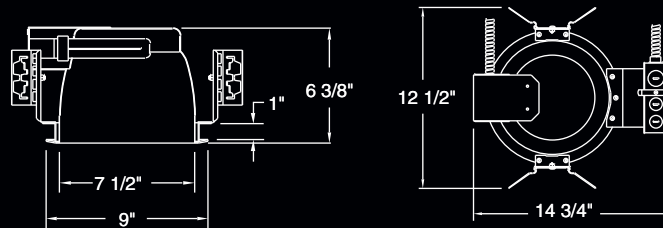

- | | | |
|-------------|--------------|-------------------------------------------------------------------------|
| | ELH 8232E | (2) 32W 4 Pin Triple Biax 120/277V Electronic Ballast |
| | ELH 8232D | (2) 32W 4 Pin Triple Biax 120/277V Electronic Dimmable Ballast, 4 Wires |
| NEW! | ELH 8232DX | (2) 32W 4 Pin Triple Biax 120V Electronic Dimmable Ballast, 2 Wires |
| NEW! | ELH 8232DX-7 | (2) 32W 4 Pin Triple Biax 277V Electronic Dimmable Ballast, 2 Wires |
| | | |
| | ELH 8242E | (2) 42W 4 Pin Triple Biax 120/277V Electronic Ballast |
| | ELH 8242D | (2) 42W 4 Pin Triple Biax 120/277V Electronic Dimmable Ballast, 4 Wires |
| NEW! | ELH 8242DX | (2) 42W 4 Pin Triple Biax 120V Electronic Dimmable Ballast, 2 Wires |
| NEW! | ELH 8242DX-7 | (2) 42W 4 Pin Triple Biax 277V Electronic Dimmable Ballast, 2 Wires |

8" Compact Fluorescent Horizontal Downlight with Plaster Frame

- Compact Fluorescent housing with plaster frame, for one or two horizontal mounted lamps with integral electronic ballast for 4 Pin compact fluorescent lamps.
- Trim support adjusts 3/4" to accommodate different ceiling thickness.
- 6 1/4" height allows use in 2 x 8 construction.
- 24" captive hanger bars included.
- U.L. damp location listed.
- Feed through listed.
- Energy Efficient

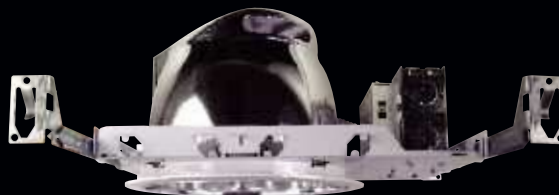

8"

EL 888C, EL 888G

Reflector with Cross Blade
O.D.: 9"



EL 862G, EL 862C

Clear and Gold Reflector with Lens
O.D.: 9"



**EL 821G, EL 821C,
EL 821F, EL 821W**
Reflector Trim
O.D.: 9"



EL 826C, EL 826G
Suspended Glass Trim with Clear Reflector
O.D.: 9"



EL 830B, EL 830W
Reflector with Baffle
O.D.: 9"



EL 842W, EL 842B
Baffle Trim with Regressed Lens
O.D.: 9"



Height: 6 3/8"
Ceiling Opening: 8"
Trim O.D.: 9"

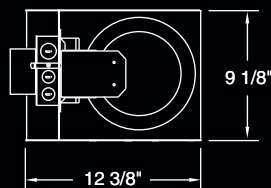
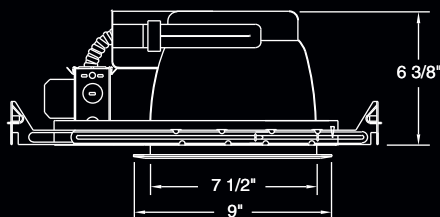

ELH 126E (1) 26W 4 Pin Quad 120/277V H.P.F. Electronic Ballast
ELH 126D (1) 26W 4 Pin Quad 120/277V Dimmable Ballast, 4 Wires
ELH 126DX (1) 26W 4 Pin Quad or Triple 120V Dimmable, 2 Wires

NEW! ELH 226E (2) 26W 4 Pin Quad 120/277V H.P.F. Electronic Ballast
ELH 226D (2) 26W 4 Pin Quad 120/277V Dimmable Ballast, 4 Wires
ELH 226DX (1) 26W 4 Pin Quad 120V Dimmable, 2 Wires

NEW! ELH 132E (1) 32W 4 Pin Triple Biax 120/277V H.P.F. Electronic Ballast
ELH 132D (1) 32W 4 Pin PL-T/32 120/277V Electronic Ballast
ELH 132DX (1) 32W 4 Pin Quad 120V Dimmable, 2 Wires

NEW! ELH 142E (1) 42W 4 Pin Triple Biax 120/277V H.P.F. Electronic Ballast
ELH 142D (1) 42W 4 Pin Triple Biax 120/277V H.P.F. Dimmable Ballast
ELH 142DX (1) 42W 4 Pin Quad 120V Dimmable, 2 Wires

8" Compact Fluorescent Horizontal Downlight with Plaster Frame

- Compact Fluorescent housing with plaster frame, for one or two horizontal mounted lamps with integral electronic ballast for 4 Pin compact fluorescent lamps.
- Trim support adjusts 3/4" to accommodate different ceiling thickness.
- 6 1/4" height allows use in 2 x 8 construction.
- 24" captive hanger bars included.
- U.L. damp location listed.
- Feed through listed.
- Energy Efficient

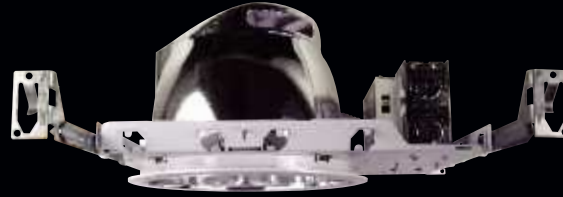

8"

EL 889C, EL 889G

Reflector with Cross Blade
O.D.: 9"



EL 882G, EL 882C

Clear and Gold Reflector with Lens
O.D.: 9"



EL 827C, EL 827G

Suspended Glass Trim with Clear Reflector
O.D.: 9"



EL 831B, EL 831W

Reflector with Baffle
O.D.: 9"



EL 841G, EL 841C, EL 841F, EL 841W

Reflector Trim
O.D.: 9"



EL 843W, EL 843B

Baffle Trim with Regressed Lens
O.D.: 9"



Height: 6 3/8"
Ceiling Opening: 8"
Trim O.D.: 9"

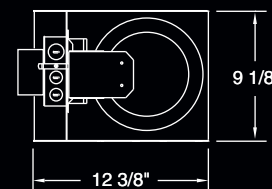
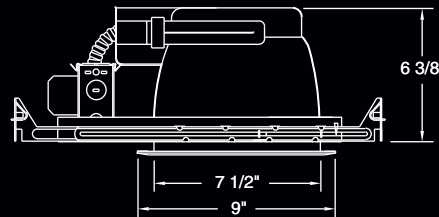

- | | |
|-------------------------|-------------------------------------------------------------------------|
| ELH 232E | (2) 32W 4 Pin Quad 120/277V H.P.F. Electronic Ballast |
| ELH 232D | (2) 32W 4 Pin Quad 120/277V H.P.F. Electronic Dimmable Ballast, 4 Wires |
| NEW! ELH 232DX | (2) 32W 4 Pin Quad 120V H.P.F. Electronic Dimmable Ballast, 2 Wires |
| NEW! ELH 232DX-7 | (2) 32W 4 Pin Quad 277V H.P.F. Electronic Dimmable Ballast, 2 Wires |
| | |
| ELH 242E | (2) 42W 4 Pin Quad 120/277V H.P.F. Electronic Ballast |
| ELH 242D | (2) 42W 4 Pin Quad 120/277V H.P.F. Electronic Dimmable Ballast, 4 Wires |
| NEW! ELH 242DX | (2) 42W 4 Pin Quad 120V H.P.F. Electronic Dimmable Ballast, 2 Wires |
| NEW! ELH 242DX-7 | (2) 42W 4 Pin Quad 277V H.P.F. Electronic Dimmable Ballast, 2 Wires |

8" Remodel Compact Fluorescent Horizontal Downlight

- Compact Fluorescent downlight for one or two horizontally mounted lamps with integral electronic ballast.
- 6 5/8" height allows use in 2 x 8 construction.
- Damp location listed.
- Feed through listed.
- Energy Efficient



Patent Pending

8"

EL 888C, EL 888G

Reflector with Cross Blade
O.D.: 9"



EL 862G, EL 862C

Clear and Gold Reflector with Lens
O.D.: 9"



EL 821G, EL 821C, EL 821F, EL 821W

Reflector Trim
O.D.: 9"



EL 826C, EL 826G

Suspended Glass Trim with Clear Reflector
O.D.: 9"



EL 830B, EL 830W

Reflector with Baffle
O.D.: 9"



EL 842W, EL 842B

Baffle Trim with Regressed Lens
O.D.: 9"



Height: 6 5/8"
Ceiling Opening: 8"
Trim O.D.: 9"

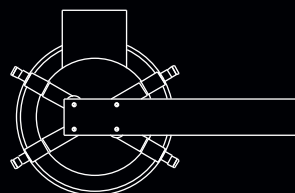
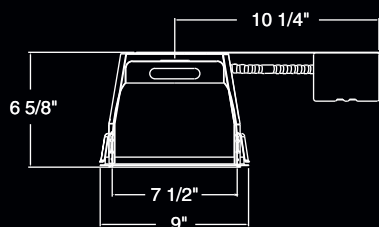

- | | |
|--------------------------|--------------------------------------------------|
| ELRH 126E | (1) 26W 4 Pin Quad 120/277V Electronic Ballast |
| ELRH 126D | (1) 26W 4 Pin Quad 120/277V Dimmable |
| NEW! ELRH 126DX | (1) 26W 4 Pin Quad 120V Dimmable, Mark X Ballast |
| NEW! ELRH 126DX-7 | (1) 26W 4 Pin Quad 277V Dimmable, Mark X Ballast |

- | | |
|--------------------------|--------------------------------------------------|
| ELRH 226E | (2) 26W 4 Pin Quad 120/277V Electronic Ballast |
| ELRH 226D | (2) 26W 4 Pin Quad 120/277V Dimmable |
| NEW! ELRH 226DX | (2) 26W 4 Pin Quad 120V Dimmable, Mark X Ballast |
| NEW! ELRH 226DX-7 | (2) 26W 4 Pin Quad 277V Dimmable, Mark X Ballast |

- | | |
|--------------------------|---------------------------------------------------|
| ELRH 132E | (1) 32W 4 Pin PL-T/32 120/277V Electronic Ballast |
| ELRH 132D | (1) 32W 4 Pin Pin PL-T/32 120/277V Dimmable |
| NEW! ELRH 132DX | (1) 32W 4 Pin Quad 120V Dimmable, Mark X Ballast |
| NEW! ELRH 132DX-7 | (1) 32W 4 Pin Quad 277V Dimmable, Mark X Ballast |

- | | |
|--------------------------|---------------------------------------------------|
| ELRH 142E | (1) 42W 4 Pin PL-T/42 120/277V Electronic Ballast |
| ELRH 142D | (1) 42W 4 Pin PL-T/42 120/277V Electronic Ballast |
| NEW! ELRH 142DX | (1) 42W 4 Pin Quad 120V Dimmable, Mark X Ballast |
| NEW! ELRH 142DX-7 | (1) 42W 4 Pin Quad 277V Dimmable, Mark X Ballast |

8" Remodel Compact Fluorescent Horizontal Downlight

- Compact Fluorescent downlight for two horizontally mounted lamps with integral electronic ballast.
- 6 5/8" height allows use in 2 x 8 construction.
- Damp location listed.
- Feed through listed.



Patent Pending

8"

EL 889C, EL 889G

Reflector with Cross Blade
O.D.: 9"



EL 882G, EL 882C

Clear and Gold Reflector with Lens
O.D.: 9"



EL 827C, EL 827G

Suspended Glass Trim with Clear Reflector
O.D.: 9"



EL 831B, EL 831W

Reflector with Baffle
O.D.: 9"



EL 841G, EL 841C, EL 841W

Reflector Trim
O.D.: 9"



EL 843W, EL 843B

Baffle Trim with Regressed Lens
O.D.: 9"



Height: 6 5/8"
Ceiling Opening: 8"
Trim O.D.: 9"

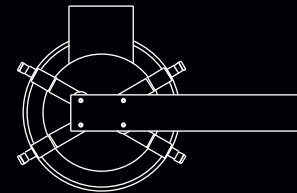
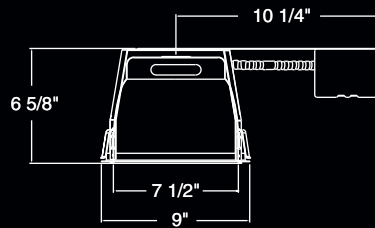

- | | | | |
|-------------|--------------|--------------------------------------------------------------|--------|
| | ELRH 232E | (2) 32W 4 Pin Triple Biax 120/277V H.P.F. Electronic Ballast | |
| | ELRH 232D | (2) 32W 4 Pin Triple Biax 120/277V Dimmable Ballast | |
| NEW! | ELRH 232DX | (2) 32W 4 Pin Triple Biax 120V Electronic Dimmable Ballast | Mark X |
| NEW! | ELRH 232DX-7 | (2) 32W 4 Pin Triple Biax 277V Electronic Dimmable Ballast | Mark X |
| | | | |
| | ELRH 242E | (2) 42W 4 Pin Triple Biax 120/277V H.P.F. Electronic Ballast | |
| | ELRH 242D | (2) 42W 4 Pin Triple Biax 120/277V Dimmable Ballast | |
| NEW! | ELRH 242DX | (2) 42W 4 Pin Triple Biax 120V Electronic Dimmable Ballast | Mark X |
| NEW! | ELRH 242DX-7 | (2) 42W 4 Pin Triple Biax 277V Electronic Dimmable Ballast | Mark X |

8" Architectural CFL Wall Wash Downlight (Spread Lens)

- Thermally protected magnetic fixtures are supplied with two single-lamp potted ballast and may be wired for independent switching. Electronic units are supplied with one two-lamp ballast for 4 pin lamps.
- Universal Mounting Bracket accepts 1/2" EMT, C-Channel, T-bar fastener and bar hangers adjusts 5" vertically from above or below ceiling.
- Junction box with 1/2" and 3/4" pryouts, listed for 8 #12 90°C conductors.
- Energy Efficient
- One lamp version available upon request.



EL 921C

Wall Wash
Reflector Trim
O.D.: 9"



EL 921G

Wall Wash
Reflector Trim
O.D.: 9"



EL 921B, EL 921W

Wall Wash
Reflector Trim
O.D.: 9"



Height: 6 3/8"
Ceiling Opening: 8"
Trim O.D.: 9"

- | | |
|-------------|-------------------------------------------------------|
| EL 800 | (2) 13W 2 Pin Quad 120V N.P.F. Ballast |
| EL 800E | (2) 13W 4 Pin Quad 120/277V H.P.F. Electronic Ballast |
| EL 800E-347 | (2) 13W 4 Pin Quad 347V H.P.F. Electronic Ballast |
| EL 800D | (2) 13W 4 Pin Quad 120/277V Dimmable Ballast |

- | | |
|-------------|--------------------------------------------------------|
| EL 850 | (2) 18W 2 Pin Quad 120V N.P.F. Ballast |
| EL 850E | (2) 18W 4 Pin Quad 120V/277V H.P.F. Electronic Ballast |
| EL 850E-347 | (2) 18W 4 Pin Quad 347V H.P.F. Electronic Ballast |
| EL 850D | (2) 18W 4 Pin Quad 120V/277V Dimmable Ballast |

- | | |
|-------------|-----------------------------------------------------------------|
| EL 875 | (2) 26W 2 Pin Quad 120V N.P.F. Ballast |
| EL 875E | (2) 26W 4 Pin Quad 120V/277V H.P.F. Electronic Dimmable Ballast |
| EL 875E-347 | (2) 26W 4 Pin Quad 347V H.P.F. Electronic Ballast |
| EL 875D | (2) 26W 4 Pin Quad 120V/277V Dimmable Ballast |

- | | |
|-------------|--------------------------------------------------------------|
| EL 880D | (2) 32W 4 Pin 120/277V Dimmable Ballast |
| EL 880E | (2) 32W 4 Pin Triple Biax 120/277V H.P.F. Electronic Ballast |
| EL 880E-347 | (2) 32W 4 Pin Triple Biax 347V H.P.F. Electronic Ballast |

- | | |
|---------|--------------------------------------------------------------|
| EL 885E | (2) 42W 4 Pin Triple Biax 120/277V H.P.F. Electronic Ballast |
| EL 885D | (2) 42W 4 Pin Triple Biax 120/277V H.P.F. Dimmable |

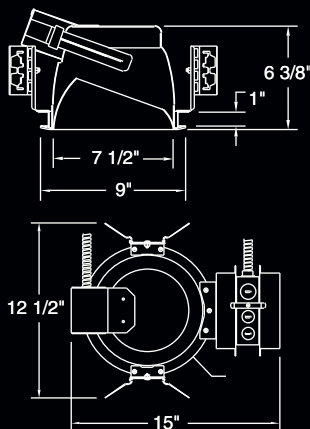

8" Square Housing and Trim

- Magnetic fixtures for are supplied with two single-lamp thermally protected potted ballast and maybe wired for independent switching.
- Electronic units are supplied with one high power multi-volt electronic ballast.
- Junction box with 1/2" and 3/4" pryout knockouts listed for 8 #12 90° conductors.
- Hanger bars included
- U.L. listed for damp locations
- U.L. feed through listed



8"

EL 10W

Square Trims with Prismatic Glass Lens
O.D.: 9 3/8 square



EL 11W

Square Trims with Fresnel Lens
O.D.: 9 3/8 square



EL 15W

Square Louvered Trim
O.D.: 9 3/8 square



Height: 4 5/8"
Ceiling Opening: 8 5/8"
Trim O.D.: 9 3/8"

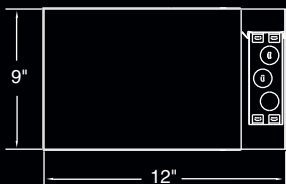
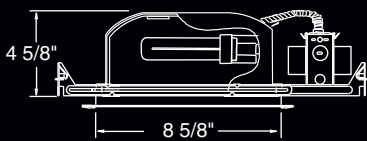

- EL 8SQ-213 (2) 13W 2 Pin Quad 120V N.P.F. Ballast
- EL 8SQ-213E (2) 13W 4 Pin Quad 120/277V Electronic Ballast

- EL 8SQ-118E (1) 18W 4 Pin Quad 120/277V Electronic
- EL 8SQ-126E (1) 26W 4 Pin Quad or Triple Biax 120V/277V Electronic Ballast
- EL 8SQ-132E (1) 32W 4 Pin Triple Biax 120/277V Electronic Ballast
- EL 8SQ-142E (1) 42W 4 Pin Triple Biax 120/277V Electronic Ballast

- EL 8SQ-126D (1) 26W 4 Pin Quad or Triple Biax 120V/277V Dimmable
- EL 8SQ-132D (1) 32W 4 Pin Triple Biax 120V/277V Dimmable
- EL 8SQ-142D (1) 42W 4 Pin Triple Biax 120V/277V Dimmable

- EL 8SQ-226E (2) 26W 4 Pin Quad or Triple Biax 120/277V Electronic Ballast
- EL 8SQ-226D (2) 26W 4 Pin Quad or Triple Biax 120/277V Dimmable

- EL 8SQ-232E (2) 32W 4 Pin Triple Biax 120/277V Electronic Ballast
- EL 8SQ-232D (2) 32W 4 Pin Triple Biax 120/277V Dimmable

- EL 8SQ-242E (2) 42W 4 Pin Triple Biax 120/277V Electronic Ballast
- EL 8SQ-242D (2) 42W 4 Pin Triple Biax 120/277V Dimmable

7" Architectural Vertical Compact Fluorescent Downlights

- Compact fluorescent fixtures designed for one vertical fluorescent lamps.
- Vertically adjustable mounting brackets accepts 1/2" EMT or C-channels (CH26) or linear bar hangers (FB27).
- Junction box with 1/2" and 3/4" pryouts, listed for 8 #12 90°C conductors.
- Trim support adjusts 3/4" to accommodate different ceiling thickness.
- U.L. damp location listed.
- U.L. feed through listed.



7"

EL 716C, EL 716G, EL716F

Reflector Trim
Lamp: (1) 42W PL Max
O.D.: 7 5/8"



EL 732G, EL 732B, EL732C, EL 732F, EL732W

Reflector with Lens
Lamp: (1) 42W PL Max
O.D.: 7 5/8"



EL 733B, EL 733N, EL 733W

Baffle with Reflector
Lamp: (1) 42W PL Max
O.D.: 7 5/8"



EL 737F

Self Flanged Clear Reflector with Fresnel Lens
Lamp: (1) 42W PL Max
O.D.: 7 5/8"



EL 738C

Clear Wall Wash Reflector trim
Lamp: (1) 42W PL Max
O.D.: 7 5/8"



NEW!

EL 755W, EL 755B

Wall Wash with Baffle
Lamp: (1) 42W PL Max
O.D.: 7 5/8"



EL 752W, EL 752B

Baffle with Clear Reflector and Lens
Lamp: (1) 42W PL Max
O.D.: 7 5/8"



Height: 9 1/4"
Ceiling
Opening: 6 1/2"
Trim O.D.: 7 5/8"

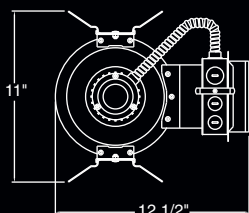
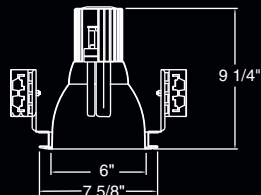

ELV 7113
ELV 7113E

(1) 13W 2 Pin Quad Tube or Twin Tube, 120V N.P.F. Magnetic Ballast
(1) 13W 4 Pin Quad 120/277V H.P.F. Electronic Ballast

ELV 7118
ELV 7118E
ELV 7118D

(1) 18W 2 Pin Quad 120V N.P.F. Magnetic Ballast
(1) 18W 4 Pin Quad Tube or Triple Tube, 120/277V H.P.F. Electronic Ballast
(1) 18W 4 Pin Quad Tube or Triple Tube, 120/277V Electronic Dimming

ELV 7126
ELV 7126E
ELV 7126D
NEW! ELV 7126DX

(1) 26W 2 Pin Quad 120V N.P.F. Magnetic Ballast
(1) 26W 4 Pin Quad Tube or Triple Tube, 120/277V H.P.F. Electronic Ballast
(1) 26W 4 Pin Quad Tube or Triple Tube, 120/277V Electronic Dimming
(1) 42W 4 Pin PL-T/42 120V Dimmable Mark X Dimmable Ballast, 120V

ELV 7132E
ELV 7132E-347
ELV 7132D
NEW! ELV 7132DX

(1) 32W 4 Pin Triple Biax, 120/277V H.P.F. Electronic Ballast
(1) 32W 4 Pin Triple Biax, 347V H.P.F. Electronic Ballast
(1) 32W 4 Pin Triple Biax, 120/277V H.P.F. Electronic Dimming
(1) 32W 4 Pin Triple Biax, 120V Dimming Mark X Ballast

ELV 7142E
ELV 7142E-347
ELV 7142D
NEW! ELV 7142DX

(1) 42W 4 Pin Triple Biax, 120/277V H.P.F. Electronic Ballast
(1) 42W 4 Pin Triple Biax, 347V H.P.F. Electronic Ballast
(1) 42W 4 Pin Triple Biax, 120/277V H.P.F. Electronic Dimming
(1) 42W 4 Pin Triple Biax, 120V Dimming Mark X Ballast

7" Compact Fluorescent Downlights Vertical with Plaster Frame

- Compact fluorescent fixture for one vertically mounted compact fluorescent lamp with integral ballast.
- Trim support adjusts 3/4" to accommodate different ceiling thickness.
- Includes 24" captive bar hangers and plaster frame.
- U.L. damp location listed.
- U.L. feed through listed.



7"

EL 716C, EL 716F, EL 716G

Reflector Trim
Lamp: (1) 42W PL Max
O.D.: 7 5/8"



EL 732C, EL 732B, EL 732F, EL 732G, EL 732W

Regressed Prismatic Lens
Lamp: (1) 42W PL Max
O.D.: 7 5/8"



EL 733B, EL 733N, EL 733W

Baffle with Reflector
Lamp: (1) 42W PL Max
O.D.: 7 5/8"



EL 737F

Regressed Fresnel Lens
Lamp: (1) 42W PL Max
O.D.: 7 5/8"



EL 738C

Clear Wall Wash Reflector trim
Lamp: (1) 42 PL Max.
O.D.: 7 5/8"

NEW!



EL 752W, EL752B

Black or White Stepped Baffle with Regressed Lens
Lamp: (1) 42W PL Max
O.D.: 7 5/8"



EL 755W, EL 755B

Wall Wash Baffle with Reflector
Lamp: (1) 42W PL Max
O.D.: 7 5/8"



Height: 9 1/4"
Ceiling Opening: 6 1/2"
Trim O.D.: 7 5/8"

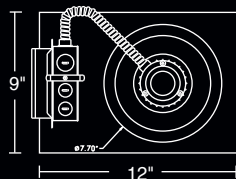
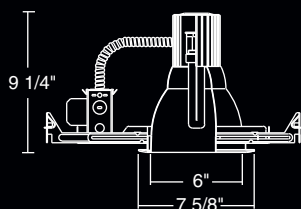

- | | |
|-----------|---------------------------------------------------------------|
| ELVF 713 | (1) 13W 2 Pin 120V Twin/Quad/Triple N.P.F. Ballast |
| ELVF 713E | (1) 13W 4 Pin Quad/Triple 120/277V H.P.F. Electronic Ballast |
| ELVF 718 | (1) 18W 2 Pin Quad/Triple 120V N.P.F. Ballast |
| ELVF 718E | (1) 18W 4 Pin Quad/Triple 120/277V H.P.F. Electronic Ballast |
| ELVF 726 | (1) 26W 2 Pin Quad/Triple 120V N.P.F. Ballast |
| ELVF 726E | (1) 26W 4 Pin Quad/Triple 120/277V H.P.F. Electronic Ballast |
| ELVF 726D | (1) 26W 4 Pin Quad/Triple 120/277V H.P.F. Dimmable Ballast |
| ELVF 732E | (1) 32W 4 Pin Triple Biax, 120/277V H.P.F. Electronic Ballast |
| ELVF 732D | (1) 32W 4 Pin Triple Biax, 120/277V H.P.F. Dimmable Ballast |
| ELVF 742E | (1) 42W 4 Pin Triple Biax, 120/277V H.P.F. Electronic Ballast |
| ELVF 742D | (1) 42W 4 Pin Triple Biax, 120/277V H.P.F. Dimmable Ballast |

NOTE: 347V Available consult factory

7" Compact Fluorescent Horizontal IC Downlight For One or Two PL Lamps

- IC Housing with thermal protector.
To be Installed in direct contact with ceiling insulation.
- Supplied with captive bar hangers for 24" joist spacing. Horizontal mount.
- U.L. damp location listed.
- U.L. feed through listed.
- Airtight Housings meet CA Title 24 Requirements (Per ASTM E283)



7"

EL 777C
Chrome Reflector with Cross Blades
O.D.: 7 5/8"



EL 762G, EL 762B, EL 762C, EL 762W
Reflector with Regressed Prismatic Lens
O.D.: 7 5/8"



EL 721C, EL 721F, EL 721G
Clear Reflector Trim
O.D.: 7 5/8"



EL 730B, EL 730N, EL 730W
Reflector with Baffle Trim
O.D.: 7 5/8"



EL 742 BZ, EL 742W, EL 742B, EL 742N
Baffle with Regressed Lens
O.D.: 7 5/8"



NEW!

EL 745W, EL 745B
Wall Wash Trim
O.D.: 7 5/8"



Height: 7 1/4"
Opening: 6 1/2"
Box: 10 1/4" x 9" x 7 1/4"
Trim O.D.: 7 5/8"

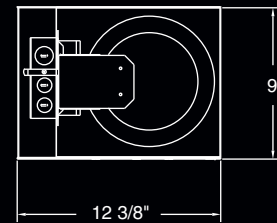
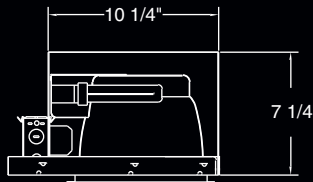

ELH 291C (2) 9W 2 Pin PL Lamp 120V N.P.F. Ballast

ELH 1131C (1) 13W 2 Pin PL Quad Lamp 120V N.P.F. Ballast

ELH 1131CE (1) 13W 4 Pin Quad Lamp 120V Electronic Ballast

ELH 2131C (2) 13W 2 Pin Quad Lamp 120V N.P.F. Ballast

ELH 2131CE (2) 13W 4 Pin PL Lamp 120/277V Electronic Ballast

ELH 2131CD (2) 13W 4 Pin PL Lamp 120/277V Dimmable Electronic Ballast

ELH 2181CE (2) 18W 4 Pin PL Lamp 120/277V Electronic Ballast

NEW! ELH 2131CEA (2) 13W 4 Pin PL Lamp 120/277V Electronic Ballast, Airtight

7" Horizontal Compact Fluorescent Downlights

- Compact fluorescent housing for two horizontally mounted lamps.
- Integral ballast for two compact fluorescent lamps.
- Universal mounting bracket accepts 1/2" EMT, C-channel, T-bar fastener and bar hanger.
- Trim support adjusts 3/4" to accommodate different ceiling thickness.
- 5 1/4" height allows use in 2 x 6 construction.
- U.L. damp location listed.
- U.L. feed through listed.



7"

EL 777C
 Chrome Reflector
 with Cross Blades
 O.D.: 7 5/8"



**EL 762G, EL 762B,
 EL 762C, EL 762W**
 Reflector with Regressed
 Prismatic Lens
 O.D.: 7 5/8"



**EL 721C, EL 721F,
 EL 721G**
 Clear Reflector Trim
 O.D.: 7 5/8"



**EL 730B, EL 730N,
 EL 730W, EL 730BZ,
 EL 730CP**
 Reflector with
 Baffle Trim
 O.D.: 7 5/8"



**EL 742BZ, EL 742CP,
 EL 742W, EL 742B,
 EL 742N**
 Baffle with Regressed Lens
 O.D.: 7 5/8"



NEW!

EL 745W, EL 745B
 Wall Wash Trim
 O.D.: 7 5/8"



Height: 5 1/4"
Ceiling Opening: 6 1/2"
Trim O.D.: 7 5/8"

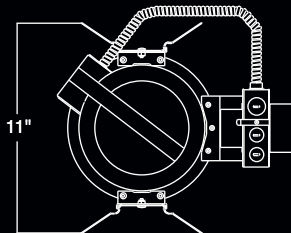
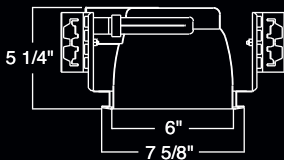

ELH 729 (2) 7W/9W 2 Pin Twin Tube 120V N.P.F. Ballast

ELH 7113 (1) 13W 2 Pin Quad 120V N.P.F. Ballast
ELH 7113E (1) 13W 4 Pin Quad 120/277V Electronic Ballast

ELH 7213 (2) 13W 2 Pin Quad 120V N.P.F. Ballast
ELH 7213E (2) 13W 4 Pin Quad 120/277V H.P.F. Electronic Ballast
ELH 7213D (2) 13W 4 Pin Quad 120/277V Dimmable Ballast

ELH 7118 (1) 18W 2 Pin Quad 120V N.P.F. Ballast
ELH 7118E (1) 18W Quad 120/277V H.P.F. Electronic Ballast

ELH 7218 (2) 18W 2 Pin Quad 120V N.P.F. Ballast
ELH 7218E (2) 18W 4 Pin Quad 120/277V H.P.F. Electronic Ballast
ELH 7218D (2) 18W 4 Pin Quad 120/277V Dimmable
NEW! ELH 7218ICE (2) 18W 4 Pin PL Lamp 120/277V Electronic Ballast

Note: Hanger Bars not included. Specify CH26 or FB27.

7" Architectural Compact Fluorescent Downlight Two PL Lamps

- A family of high brightness downlights for use with 26W, 32W and 42W triple tube lamps.
- The precisely formed non-imaging optical reflector ensures equal cutoff to lamp and lamp image.
- One ballast operates the 26W, 32W, 42W triple biax lamps. These optics offer unparalleled performance in glare free lighting with a uniform wide beam devoid of hot spots.
- Universal mounting bracket accepts 1/2" EMT, C-channel, T-bar fastener and bar hanger.
- Trim support adjusts 3/4" to accommodate different ceiling thickness. Trims can be installed without tools.
- U.L. damp location listed.
- U.L. feed through listed.

NEW!



7"

EL 782G, EL 782B, EL 782C, EL 782W
 Regressed Prismatic Lens with Reflector
 O.D.: 7 5/8"



EL 778C
 Chrome Reflector with Cross Blades
 O.D.: 7 5/8"



EL 731W, EL 731B, EL 731N
 Reflector with Baffle Trim
 O.D.: 7 5/8"



EL 741G, EL 741C, EL 741F
 Reflector Trim
 O.D.: 7 5/8"



EL 743W, EL 743B, EL 743N
 Baffle with Regressed Lens
 O.D.: 7 5/8"



EL 746B, EL 746W
 Reflector Trim
 O.D.: 7 5/8"



Height: 5"
 Ceiling Opening: 6 1/2"
 Trim O.D.: 7 5/8"

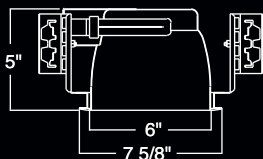

NEW! ELH 7126
NEW! ELH 7126E
NEW! ELH 7126D
NEW! ELH 7126DX
NEW! ELH 7126DX-7

- (1) 26W 2 Pin Quad 120V N.P.F. Ballast
- (1) 26W 4 Pin Quad or Triple 120/277V Electronic Ballast
- (1) 26W 4 Pin Quad or Triple 120/277V Dimmable Ballast
- (1) 26W 4 Pin Quad or Triple 120V with Dimmable Mark X Ballast
- (1) 26W 4 Pin Quad or Triple 277V with Dimmable Mark X Ballast

NEW! ELH 7226
NEW! ELH 7226E
NEW! ELH 7226D
NEW! ELH 7226DX
NEW! ELH 7226DX-7

- (2) 26W 2 Pin Quad 120V N.P.F. Ballast
- (2) 26W 4 Pin Quad Biax 120/277V H.P.F. Electronic Ballast
- (2) 26W 4 Pin Quad 120/277V Dimmable Electronic Ballast
- (2) 26W 4 Pin Quad or Triple 120V with Dimmable Mark X Ballast, 120V
- (2) 26W 4 Pin Quad or Triple 277V with Dimmable Mark X Ballast

NEW! ELH 7132E
NEW! ELH 7132D
NEW! ELH 7132DX
NEW! ELH 7132DX-7

- (1) 32W 4 Pin Quad or Triple 120/277V Electronic Ballast
- (1) 32W 4 Pin Quad or Triple 120/277V Dimmable Ballast
- (1) 32W 4 Pin Quad or Triple 120V with Dimmable Mark X Ballast
- (1) 32W 4 Pin Quad or Triple 277V with Dimmable with Mark X Ballast

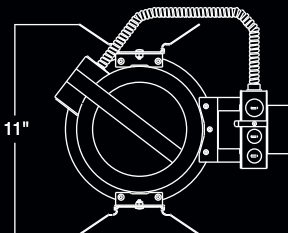

NEW! ELH 7142E
NEW! ELH 7142D
NEW! ELH 7142DX
NEW! ELH 7142DX-7

- (1) 42W 4 Pin Quad or Triple 120/277V Electronic Ballast
- (1) 42W 4 Pin Quad or Triple 120/277V Dimmable Ballast
- (1) 42W 4 Pin Quad or Triple 120V with Dimmable Mark X Ballast
- (1) 42W 4 Pin Quad or Triple 277V with Dimmable Mark X Ballast

NOTE: 347V Available consult factory

7" Horizontal Compact Fluorescent Downlights For One or Two PL Lamps

- A compact fluorescent housing for two horizontally mounted lamps.
- Integral ballast for two 13W twin tube compact fluorescent lamps.
- Adjustable bar hangers will span 24" and can be repositioned 90°.
- 5" height allows use in 2 x 6 construction.
- Trim support adjusts 3/4" to accommodate different ceiling thickness.
- U.L. damp location listed.
- U.L. feed through listed.



7"

EL 777C

Chrome Reflector with Cross Blades
O.D.: 7 5/8"



EL 762G, EL 762B, EL 762C, EL 762W

Reflector with Regressed Prismatic Lens
O.D.: 7 5/8"



EL 721C, EL 721F, EL 721G

Clear Reflector Trim
O.D.: 7 5/8"



EL 730B, EL 730N, EL 730W

Reflector with Baffle Trim
O.D.: 7 5/8"



EL 742BZ, EL742W, EL 742B, EL 742N

Baffle with Regressed Lens
O.D.: 7 5/8"

NEW!



EL 745W, EL 745B

Wall Wash Trim
O.D.: 7 5/8"



Height: 5"
Ceiling Opening: 6 1/8"
Trim O.D.: 7 5/8"

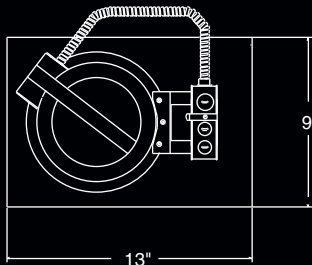
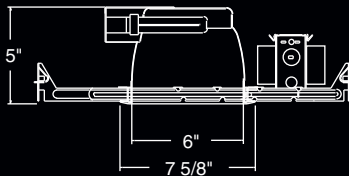

ELH 29

(2) 7W/9W 2 Pin Twin Tube 120V N.P.F. Ballast

ELH 113
ELH 113E

(1) 13W 2 Pin Quad PL 120V N.P.F. Ballast
(1) 13W 4 Pin Quad PL 120/277V H.P.F. Electronic Ballast

ELH 118
ELH 118E
ELH 118D

(1) 18W 2 Pin Quad 120V N.P.F. Ballast
(1) 18W 4 Pin Quad 120/277V Electronic Ballast
(2) 18W 4 Pin PL Lamp 120/277V Dimmable Electronic Ballast

ELH 213
ELH 213E
ELH 213D

(2) 13W 2 Pin Quad/Twin Tube 120V N.P.F. Ballast
(2) 13W 4 Pin Quad 120/277V H.P.F. Electronic Ballast
(2) 13W 4 Pin PL Quad 120/277V Dimmable Electronic Ballast

ELH 218
ELH 218E
ELH 218D
NEW! ELH 218DX

(2) 18W 2 Pin Quad 120V N.P.F. Ballast
(2) 18W 4 Pin Quad 120/277V H.P.F. Electronic Ballast
(2) 18W 4 Pin PL Lamp 120/277V Dimmable Electronic Ballast
(2) 18W 4 Pin Quad 120V Dimmable Mark X Ballast

NOTE: 347V Available consult factory

7" Horizontal Remodel Compact Fluorescent Downlights

- Compact fluorescent housing for two horizontally mounted lamps.
- Integral Thermally Protected Ballast
- Trim support adjusts 3/4" to accommodate different ceiling thickness.
- 5 1/4" height allows use in 2 x 6 construction.
- U.L. damp location listed.
- U.L. feed through listed.



Patent Pending

7"

EL 777C

Chrome Reflector with Cross Blades
O.D.: 7 5/8"



EL 762G, EL 762B, EL 762C, EL 762W

Reflector with Regressed Prismatic Lens
O.D.: 7 5/8"



EL 721C, EL 721F, EL 721G

Clear Reflector Trim
O.D.: 7 5/8"



EL 730CP, EL 730B, EL 730N, EL 730W, EL 730BZ, NEW!

Reflector with Baffle Trim
O.D.: 7 5/8"



EL 742BZ, EL 742CP, EL 742W, EL 742B, EL 742N, NEW!

Baffle with Regressed Lens
O.D.: 7 5/8"



EL 745W, EL 745B

Wall Wash Trim
O.D.: 7 5/8"



Height: 5 1/4"
Ceiling Opening: 6 1/2"
Trim O.D.: 7 5/8"

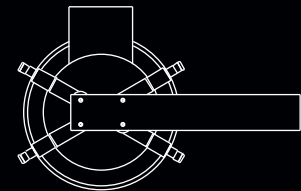
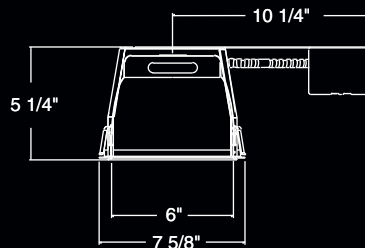

ELRH 113E

(1) 13W 4 Pin Quad 120/277V Electronic Ballast

ELRH 118D

(1) 18W 4 Pin Quad 120/277V Dimming Ballast

ELRH 213

(2) 13W 2 Pin Quad 120V N.P.F. Ballast

ELRH 213E

(2) 13W 4 Pin Quad 120/277V Electronic Ballast

ELRH 213D

(2) 13W 4 Pin Quad 120/277V Electronic Dimming Ballast

ELRH 218E

(2) 18W 4 Pin Quad 120/277V Electronic Ballast

ELRH 218D

(2) 18W 4 Pin Quad 120/277V Electronic Dimming Ballast

NEW! ELRH 218DX

(2) 18W 4 Pin Quad 120V with Mark X Ballast

NEW! ELRH 218DX-7

(2) 18W 4 Pin Quad 277V with Mark X Ballast

7" Energy Efficient Remodel Compact Fluorescent Horizontal Downlights

- Compact fluorescent housing for two horizontally mounted lamps.
- Integral electronic ballast
- Trim support adjusts 3/4" to accommodate different ceiling thickness.
- 5 1/4" height allows use in 2 X 6 construction.
- U.L. damp location listed
- U.L. feed through listed
- Thermally protected "Class P", HPF electronic ballast (universal voltage)
- Emergency battery back-up ballast (optional)



7"

**EL 782G, EL 782B,
EL 782C, EL 782W**
Regressed Prismatic
Lens with Reflector
O.D.: 7 5/8"



EL 778C
Chrome Reflector
with Cross Blades
O.D.: 7 5/8"



**EL 731W, EL 731B,
EL 731N**
Reflector with Baffle Trim
O.D.: 7 5/8"



**EL 741G, EL 741C,
EL 741F**
Reflector Trim
O.D.: 7 5/8"



**EL 743W, EL 743B,
EL 743N**
Baffle with Regressed Lens
O.D.: 7 5/8"



EL 746B, EL 746W
Reflector Trim
O.D.: 7 5/8"



Height: 5 1/4"
Ceiling Opening: 6 1/2"
Trim O.D.: 7 5/8"

NEW! ELRH 7226E
ELRH 7126D

- (2) 26W 4 Pin Quad Lamp 120/277 Electronic Ballast
- (1) 26W 4 Pin Quad/Triple Lamp 120/277 0-10V Electronic Dimmable Ballast

NEW! ELRH 7126DX
NEW! ELRH 7126DX-7

- (1) 26W 4 Pin Quad/Triple Lamp 120V with Dimmable Mark X Ballast
- (1) 26W 4 Pin Quad/Triple Lamp 277V with Dimmable Mark X Ballast

ELRH 7132E
ELRH 7132D
Ballast

- (1) 32W 4 Pin Quad/Triple Lamp 120/277 Electronic Ballast
- (1) 32W 4 Pin Quad/Triple Lamp 120/277 0-10V Electronic Dimmable Ballast

NEW! ELRH 7132DX
NEW! ELRH 7132DX-7

- (1) 32W 4 Pin Quad/Triple Lamp 120V with Dimmable Mark X Ballast
- (1) 32W 4 Pin Quad/Triple Lamp 277V with Dimmable Mark X Ballast

ELRH 7142E
ELRH 7142D
Ballast

- (1) 42W 4 Pin Quad/Triple Lamp 120/277 Electronic Ballast
- (1) 42W 4 Pin Quad/Triple Lamp 120/277 0-10V Electronic Dimmable Ballast

NEW! ELRH 7142DX
NEW! ELRH 7142DX-7

- (1) 42W 4 Pin Quad/Triple Lamp 120V with Dimmable Mark X Ballast
- (1) 42W 4 Pin Quad/Triple Lamp 277V with Dimmable Mark X Ballast

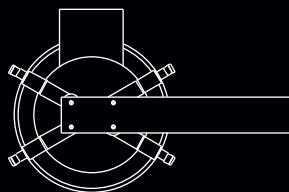
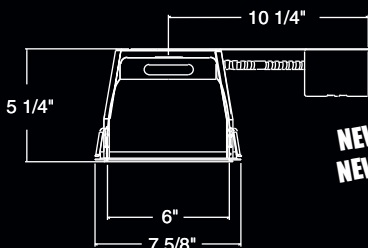

7" Architectural Compact Fluorescent Wall Wash Downlight with Spread Lens

- Compact fluorescent housing for two horizontally mounted lamps.
- Universal Mounting Bracket accepts 1/2" EMT, C-Channel, Tbar fastener and bar hangers.
- Thermally protected magnetic fixtures are supplied with two single-lamp potted ballast and may be wired for independent switching.
- Junction box with 1/2" and 3/4" pryouts, listed for 8 #12 90°C conductors.
- Electronic units are supplied with one two-lamp ballast for 4 pin lamps.
- Energy Efficient



7"

EL 621B

Wall Wash
Reflector Trim
O.D.: 9"



EL 621C

Wall Wash
Reflector Trim
O.D.: 9"



EL 621G, EL 621W

Wall Wash
Reflector Trim
O.D.: 9"



Height: 5"

Ceiling Opening: 6 1/2"

Trim O.D.: 7 5/8"

EL 600 (2) 7W/9W 2 Pin Twin Tube 120V N.P.F. Ballast

EL 700 (2) 13W 2 Pin Quad 120V N.P.F. Ballast

EL 700E (2) 13W 4 Pin Quad 120V/277V H.P.F. Electronic Ballast

EL 700D (2) 13W 4 Pin Quad 120V/277V Dimmable

EL 750 (2) 18W 2 Pin Quad 120V N.P.F. Ballast

EL 750E (2) 18W 4 Pin Quad 120V/277V H.P.F. Electronic Ballast

EL 750D (2) 18W 4 Pin Quad 120V/277V Dimmable

EL 775 (2) 26W 2 Pin Quad 120V N.P.F. Ballast

EL 775E (2) 26W 4 Pin Quad 120/277V H.P.F. Electronic Ballast

EL 775D (2) 26W 4 Pin Quad 120/277V Dimmable

NEW! EL 775DX (2) 26W 4 Pin Quad 120V Dimmable with Mark X Ballast

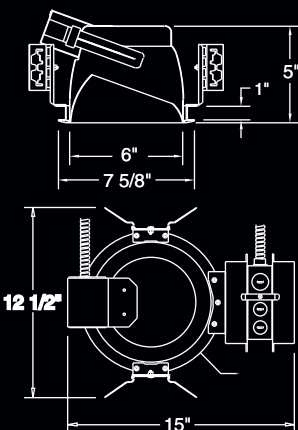

One lamp units available upon request.

NOTE: 347V Available consult factory



6" Universal Compact Fluorescent Downlight

- Thermally protected housing for one compact fluorescent lamp.
- Housing adjusts 1 3/8" to accommodate different ceiling thickness.
- Supplied with captive bar hangers for 24" joist spacing and can be positioned 90°.
- 7 1/2" Height allows for use in 2 x 8 construction.
- U.L. damp location listed.
- U.L. feed through listed.



6"

Height: 7 1/2"
Opening: 6 1/4"
Trim O.D.: 7 1/4"

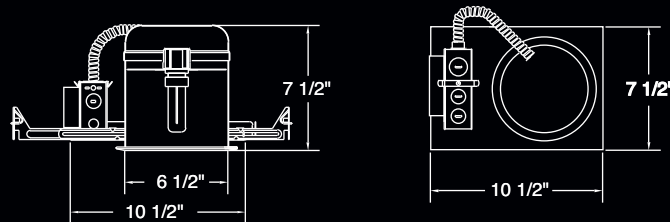

EL 27HE13	(1) 13W 4 Pin Quad or Triple Biax 120/277V H.P.F. Electronic Ballast
EL 27H13D	(1) 13W 4 Pin Triple Biax 120/277V H.P.F. Electronic Dimming Ballast
EL 27HE18	(1) 18W 4 Pin Quad or Triple Biax 120/277V H.P.F. Electronic Ballast
EL 27H18D	(1) 18W 4 Pin Quad or Triple Biax 120/277V H.P.F. Electronic Dimming Ballast
NEW! EL 27H18DX	(1) 18W 4 Pin PL-T/32 120V H.P.F. Electronic Dimmable Ballast, Mark X
EL 27HE26	(1) 26W 4 Pin Triple Biax 120/277V H.P.F. Electronic Ballast
EL 27H26D	(1) 26W 4 Pin Triple Biax 120/277V H.P.F. Electronic Dimming Ballast
NEW! EL 27H26DX	(1) 26W 4 Pin PL-T/32 120V H.P.F. Electronic Dimmable Ballast, Mark X
NEW! EL 27H26DX-7	(1) 26W 4 Pin PL-T/32 277V Dimmable with Mark X Ballast
EL 27HE32	(1) 32W 4 Pin Triple Biax 120/277V H.P.F. Electronic Ballast
EL 27HE32-347	(1) 32W 4 Pin Triple Biax 347V H.P.F. Electronic Ballast
NEW! EL 27H32D	(1) 32W 4 Pin Triple Biax 120/277V H.P.F. Electronic Dimming Ballast
NEW! EL 27H32DX	(1) 32W 4 Pin PL-T/32 120V H.P.F. Electronic Dimmable Ballast, Mark X
EL 27HE42	(1) 42W 4 Pin Triple Biax 120/277V H.P.F. Electronic Ballast
EL 27H42D	(1) 42W 4 Pin Triple Biax 120/277V H.P.F. Electronic Dimming Ballast
EL 27H42DX	(1) 42W 4 Pin PL-T/42 120V 50/60Hz H.P.F. Electronic Dimming Ballast, Mark X
NEW! EL 27H42DX-7	(1) 42W 4 Pin PL-T/32 277V Dimmable Ballast, Mark X

6" Compact Fluorescent Vertical Downlight for 1PL Lamp, IC Rated

- Thermally protected electronic ballast
- Housing adjusts 1 3/8" to accommodate different ceiling thickness.
- Supplied with captive bar hangers for 24" Joist spacing, can be repositioned 90°.
- 7 1/2" height allow for use in 2 x 8 construction.
- U.L. listed for feed through
- IC Housings can be used in insulated ceilings
- Adjustable socket bracket
- Electronic Airtight housings meet CA Title24 requirements.



6"

Height: 7 1/2"
 Opening: 6 1/4"
 Trim O.D.: 7 1/4"

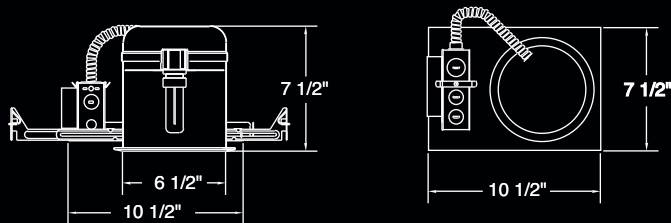

NEW!

	EL 27HICA	(1) 13W 2 Pin Quad 120V N.P.F. Ballast Can be covered with insulation. Airtight housing.
	EL 27HE13IC	(1) 13W 4 Pin, 120/277V H.P.F. Electronic Ballast, IC Airtight
	T24 EL 27HE13ICA	(1) 13W 4 Pin, Quad 120V Electronic Ballast, IC Airtight, CA. Title 24 with ENERGY STAR qualified ballast
	T24 EL 27H13ICDA	(1) 13W 4 Pin Quad or Triple Biax 120/277V Dimmable, IC Airtight
	EL 27HE18IC	(1) 18W 4 Pin Quad or Triple Biax 120/277V H.P.F. Electronic Ballast, IC
	T24 EL 27HE18ICA	(1) 18W 4 Pin Quad or Triple Biax 120V Electronic Ballast, IC Airtight, with ENERGY STAR qualified ballast
	T24 EL 27H18ICDA	(1) 18W 4 Pin Quad or Triple Biax 120/277V Dimmable, IC Airtight
	T24 EL 27H18ICD1A	(1) 18W 4 Pin Quad/Triple, 120V, Dimmable N.P.F. Ballast, IC Airtight, CA. Title 24, with ENERGY STAR qualified ballast
	EL 27HE26IC	(1) 26W 4 Pin Quad or Triple Biax 120/277V H.P.F. Electronic Ballast, IC
	T24 EL 27HE26ICA	(1) 26W 4 Pin Quad or Triple Biax 120V Electronic Ballast, IC Airtight, with ENERGY STAR qualified ballast
	T24 EL 27H26ICDXA	(1) 26W 4 Pin Quad or Triple Biax 120V with Mark X Dimmable Electronic Ballast, IC Airtight
	T24 EL 27HE26ICAN	(1) 26W 4 Pin Quad or Triple Biax 120V H.P.F. Electronic, No Bracket with ENERGY STAR qualified ballast
	T24 EL 27H26ICDA	(1) 26W 4 Pin Quad or Triple Biax 120/277V Dimmable, IC Airtight
	T24 EL 27H26ICD1A	(1) 26W 4 Pin Quad/Triple, 120V, Dimmable N.P.F. Ballast, IC Airtight, CA. Title 24, with ENERGY STAR qualified ballast

6" Compact Fluorescent Vertical Downlight, Electronic IC, 32W, 42W

- Integral electronic ballast for one compact fluorescent lamp.
- Housing adjusts 1 3/8" to accommodate different ceiling thickness.
- Supplied with captive hanger bars for 24" joist spacing.
- 7 1/2" Height allows for use in 2 x 8 construction.
- Feed through junction box.
- U.L. damp location listed.
- For use in insulated ceilings
- Airtight housings meet CA Title24 requirements (Per ASTM E283 standards)

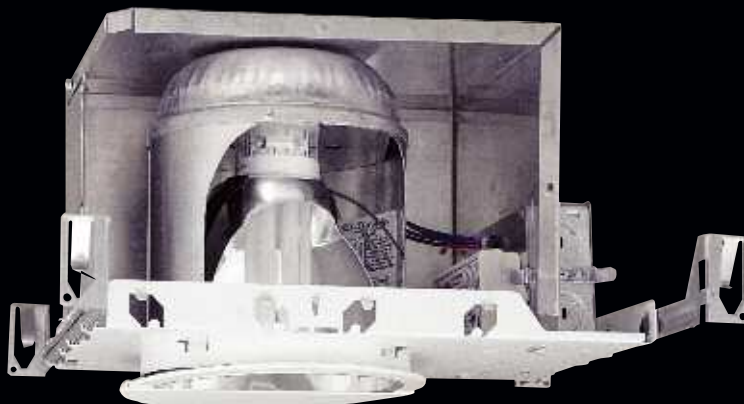

6"

Height: 7 1/4"
 Opening: 6 1/2"
 Trim O.D.: 7 1/4"

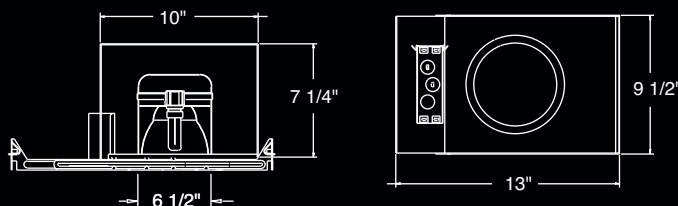

NEW!

- | | | |
|------------|----------------------|----------------------------------------------------------------------|
| T24 | EL 27HE32ICA | (1) 32W 4 Pin Triple Biax 120/277V H.P.F Ballast, Airtight |
| T24 | EL 27H32ICDA | (1) 32W 4 Pin Triple Biax 120/277V H.P.F Ballast, Airtight |
| T24 | EL 27H32ICDXA | (1) 32W 4 Pin Triple Biax 120V, Mark X Dimmable Ballast, IC Airtight |
| T24 | EL27HE42ICA | (1) 42W 4 Pin, 120/277V Electronic Ballast, Airtight |
| T24 | EL 27H42ICDA | (1) 42W 4 Pin, 120/277V Dimmable Ballast, Airtight |
| T24 | EL 27H42ICDXA | (1) 42W 4 Pin Triple Biax 120V, Mark X Dimmable Ballast, IC Airtight |

6" Remodel Compact Fluorescent Vertical Downlight

- 6" Remodel Housing for 1 compact fluorescent lamp.
- Thermally protected ballast.
- Housing adjusts 1 3/8" to accommodate different ceiling thickness.
- 7 1/2" Height allows for use in 2 x 8 construction.
- U.L. damp location listed.
- U.L. feed through listed.



6"

Height: 7 1/2"
Opening: 6 3/8"
Trim O.D.: 7 1/4"

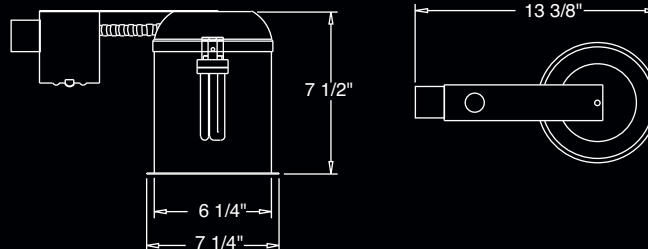

EL 27RHE13	(1) 13W 4 Pin Quad or Triple Biax 120/277V H.P.F. Electronic Ballast
EL 27RHE18	(1) 18W 4 Pin Quad or Triple Biax 120/277V H.P.F. Electronic Ballast
EL 27RH18D	(1) 18W 4 Pin Quad or Triple Biax 120/277V Electronic Dimming Ballast
EL 27RH18DX	(1) 18W 4 Pin Quad or Triple Biax 120V H.P.F. Electronic Dimmable with Mark X Ballast
EL 27RH18DX-7	(1) 18W 4 Pin Quad or Triple Biax 277V H.P.F. Electronic Dimmable with Mark X Ballast
EL 27RHE26	(1) 26W 4 Pin Quad or Triple Biax 120/277V Electronic Ballast
EL 27RH26D	(1) 26W 4 Pin Quad or Triple Biax 120/277V H.P.F. Electronic Dimming Ballast
EL 27RH26DX	(1) 26W 4 Pin Quad or Triple Biax 120V H.P.F. Electronic Dimmable with Mark X Ballast
EL 27RH26DX-7	(1) 26W 4 Pin Quad or Triple Biax 277V H.P.F. Electronic Dimmable with Mark X Ballast
EL 27RHE32	(1) 32W 4 Pin Triple Biax 120/277V H.P.F. Electronic Ballast
EL 27RH32D	(1) 32W 4 Pin Triple Biax 120/277V H.P.F. Electronic Dimming Ballast
EL 27RH32DX	(1) 32W 4 Pin PL-T 120V H.P.F. Electronic Dimmable with Mark X Ballast
EL 27RH32DX-7	(1) 32W 4 Pin PL-T 277V H.P.F. Electronic Dimmable with Mark X Ballast
EL 27RHE42	(1) 42W 4 Pin Triple Biax 120/277V H.P.F. Electronic Ballast
EL 27RH42D	(1) 42W 4 Pin PL-T/42 120/277V H.P.F. Electronic Dimmable Ballast
EL 27RH42DX	(1) 42W 4 Pin PL-T 120V H.P.F. Electronic Dimmable with Mark X Ballast
EL 27RH42DX-7	(1) 42W 4 Pin PL-T 277V H.P.F. Electronic Dimmable with Mark X Ballast

6" Remodel Compact Fluorescent Vertical Downlight, IC Airtight

- 6" Remodel Housing for use in insulated ceilings
- Thermally protected electronic ballast.
- 7 1/2" Height allows for use in 2 x 8 construction.
- Electronic Airtight Housing Meet CA Title 24, IECC requirements.
- U.L. damp location listed.
- U.L. feed through listed



Height: 7 1/2"
Opening: 6 3/8"
Trim O.D.: 7 1/4"

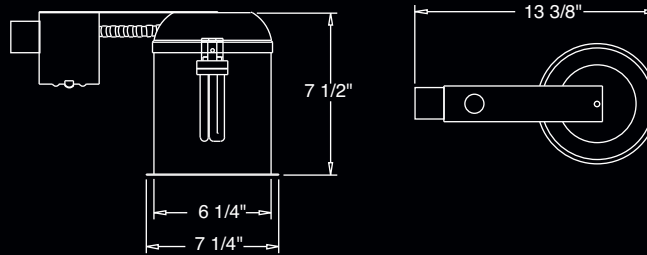

6"

NEW!

EL 27RHICA (1) 13W 2 Pin Quad 120V N.P.F. Ballast
Can be covered with insulation.

EL 27RHE13IC (1) 13W 4 Pin Quad/Triple, 120/277 Electronic Ballast, IC Housing

T24 **EL 27RHE13ICA** (1) 13W 4 Pin Quad or Triple Biax 120V Electronic Ballast, IC Airtight

T24 **EL 27RH13ICDA** (1) 13W 4 Pin Quad or Triple Biax 120/277V Dimmable, IC Airtight

EL 27RHE18IC (1) 18W 4 Pin Quad/Triple, 120/277 Electronic Ballast, IC Housing

T24 **EL 27RHE18ICA** (1) 18W 4 Pin Quad or Triple Biax 120V Electronic Ballast, IC Airtight, with ENERGY STAR qualified ballast

T24 **EL 27RH18ICDA** (1) 18W 4 Pin Quad or Triple Biax 120/277V Dimmable, IC Airtight

T24 **EL 27R18ICD1A** (1) 18W 4 Pin Quad/Triple, 120V, Dimmable N.P.F. Ballast, IC Airtight, Title 24

EL 27RHE26IC (1) 26W 4 Pin Quad/Triple, 120/277 Electronic Ballast, IC Housing

T24 **EL 27RHE26ICA** (1) 26W 4 Pin Quad or Triple Biax 120V Electronic Airtight Ballast, with ENERGY STAR qualified ballast

T24 **EL 27RH26ICDA** (1) 26W 4 Pin Quad or Triple Biax 120/277V H.P.F. Electronic Dimmable Ballast,

T24 **EL 27R26ICD1A** (1) 26W 4 Pin Quad/Triple, 120V, Dimmable N.P.F. Ballast, IC Airtight, Title 24, with ENERGY STAR qualified ballast

T24 **EL 27RH26ICDXA** (1) 26W 4 Pin Quad or Triple Biax 120V H.P.F. with Mark X Dimmable Ballast

6" Compact Fluorescent Trims

EL 12W
EL 12SH

Albalite Shower Trim
Lamp: (1) 42W Max CFL
O.D.: 8"



EL 112W
EL 112G
EL 112SH

Shower Trim with
Reflector and Albalite Lens
Lamp: (1) 42W Max CFL
O.D.: 8"



EL 13W
EL 13SH

Shower Trim
with Fresnel Lens
Lamp: (1) 42W Max CFL
O.D.: 8"



EL 113BZ **NEW!**
Shower Trim with
Reflector and Fresnel Lens
Lamp: (1) 42W Max CFL
O.D.: 8"



EL 22W
EL 22SH

Shower Trim
Frosted Lens
Lamp: (1) 42W Max CFL
O.D.: 8"



EL 113CP **NEW!**
Shower Trim with
Reflector and Fresnel Lens
Lamp: (1) 42W Max CFL
O.D.: 8"



EL 16BZ **NEW!**

Drop Opal
Shower Trim
Lamp: (1) 42W Max CFL
O.D.: 8"



EL 113W
EL 113G
EL 113SH
Shower Trim with
Reflector and Fresnel Lens
Lamp: (1) 42W Max CFL
O.D.: 8"



EL 16CP **NEW!**

Drop Opal
Shower Trim
Lamp: (1) 42W Max CFL
O.D.: 8"



EL 122 W
EL 122SH
Shower Trim with
Reflector and Frosted Lens
Lamp: (1) 42W Max CFL
O.D.: 8"



EL 16W
EL 16SH

Drop Opal Shower Trim
Lamp: (1) 42W Max CFL
O.D.: 8"



EL 116BZ **NEW!**
Shower Trim
with Reflector
and Drop Opal Lens
Lamp: (1) 42W Max CFL
OD: 8"



EL 112BZ **NEW!**

Shower Trim with
Reflector and Albalite Lens
Lamp: (1) 42W Max CFL
O.D.: 8"



EL 116CP **NEW!**
Shower Trim
with Reflector
and Drop Opal Lens
Lamp: (1) 42W Max CFL
OD: 8"



EL 112CP **NEW!**

Shower Trim with
Reflector and Albalite Lens
Lamp: (1) 42W Max CFL
O.D.: 8"



EL 116W
EL 116G
EL 116SH
Shower Trim
with Reflector
and Drop Opal Lens
Lamp: (1) 42W Max CFL
OD: 8"



6" Compact Fluorescent Trims (Cont.)

EL 319W

Shower Trim
with Reflector
and drop opal
plastic lens
Lamp: (1) 13W MAX CFL
O.D.: 7 5/8"

NEW!



ELM 422W

Baffle with
Regressed
Frosted Lens
Lamp: (1) 42W MAX CFL
O.D.: 7 1/4"

NEW!



ELA 95SW

ELA 95SB

ELA 95SC

ELA 95SG

Wall Wash with Reflector
Lamp: (1) 42W Max CFL
O.D.: 7 1/4"



ELA 99SC

Clear Reflector Trim
Lamp: (1) 42W Max CFL
O.D.: 7 1/4"



ELA 99SG

Gold Reflector Trim
Lamp: (1) 42W Max CFL
O.D.: 7 1/4"



ELA 99SW

ELA 99SB

Reflector
Lamp: (1) 42W Max CFL
OD: 7 1/4"



ELA 101B

ELA 101N

ELA 101NB

Baffle with Reflector
Lamp: (1) 42W Max CFL
OD: 7 1/4"



ELA 101BZ

Baffle with Reflector
Lamp: (1) 42W Max CFL
O.D.: 7 1/4"

NEW!



ELA 101CP

Baffle with Reflector
Lamp: (1) 42W Max CFL
O.D.: 7 1/4"

NEW!



ELA 105W

ELA 105B

Wall Wash
Baffle with Reflector
Lamp: (1) 42W Max CFL
O.D.: 7 1/4"



ELM 46W

ELM 46B

Stepped Baffle with
Regressed Drop Opal Lens
Lamp: (1) 42W Max CFL
O.D.: 7 1/4"



ELM 47W

Baffle with
Regressed Frosted Lens
Lamp: 60W-A19
O.D.: 7 1/4"

NEW!



ELM 300W

ELM 300B

ELM 300BZ

Airtight Metal Baffle Cone
Trim with Torsion Springs.
Self Flanged.
Lamp: (1) 42W Max CFL
O.D.: 7 1/4"



ELM 301W

Airtight Cone Trim
with Torsion Springs.
Lamp: (1) 42W MAX CFL

NEW!



ELM 412W

Baffle Reflector trim with
Regressed Albalite Lens
Lamp: (1) 26W MAX CFL
O.D.: 7 1/4"

NEW!



ELS 42C

ELS 42W

Albalite Shower
Trim with Reflector
Lamp: (1) 26W Max CFL
O.D.: 7 1/4"



ELS 310C

Airtight Parabolic
Chrome Reflector
Trim with Torsion
Springs. Self Flanged.
Lamp: (1) 42W MAX CFL
O.D.: 7 1/4"

NEW!



ELS 311C

Airtight Chrome Reflector
Core Trim with Torsion
Springs. Self Flanged.
Lamp: (1) 42W Max CFL
O.D.: 7 1/4"



6" Compact Fluorescent Vertical Downlight (2) 13W

- Integral ballast for two compact fluorescent lamps. One magnetic ballast per lamp or one electronic ballast for two lamps.
- 7 1/2" height allows for use in 2 x 8 construction.
- Housing adjusts 1 3/8" to accommodate different ceiling thicknesses.
- Supplied with captive hanger bars for 24" joist spacing and can be repositioned at 90°.
- Thermally protected ballast.
- U.L. damp location listed.
- U.L. feed through listed.

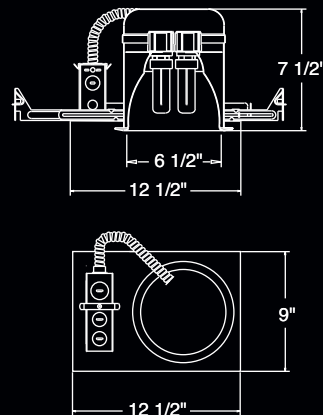

NEW!

6"

6" Compact Fluorescent New Construction Housing
 Height: 7 1/2"
 Opening: 6 1/2"
 Trim O.D.: 7 1/4"

- EL 27H213E (2) 13W 4 Pin Quad 120/277V H.P.F. Electronic Ballast
- EL 27H213D (2) 13W 4 Pin Quad 120/277V H.P.F. Electronic Dimming Ballast
-  EL 27H213ICA (2) 13W 2 Pin Quad 120V N.P.F. Ballast, with ENERGY STAR qualified ballast. Airtight housing can be covered with insulation.

- Integral ballast for two compact fluorescent lamps. One magnetic ballast per lamp or one electronic ballast for two lamps.
- 7 1/2" height allows for use in 2 x 8 construction.
- Thermally protected.
- U.L. damp location listed.
- U.L. feed through listed.

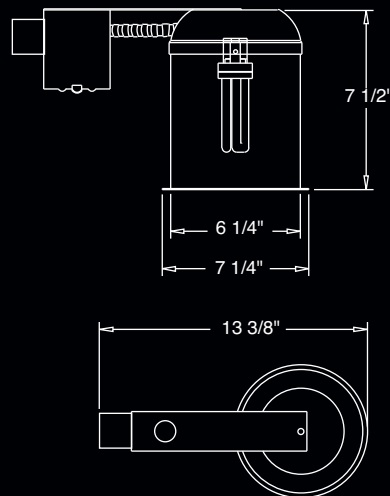

6"

6" Compact Fluorescent Remodel Housing
 Height: 7 1/2"
 Opening: 6 1/2"
 Trim O.D.: 7 1/4"

- NEW!** EL 27RH-213ICA (2) 13W 2 Pin Quad 120V, N.P.F. Ballast, IC Airtight
- EL 27RH213E (2) 13W 4 Pin Quad 120/277V H.P.F. Electronic Ballast
- EL 27RH213D (2) 13W 4 Pin Quad 120/277V H.P.F. Electronic Dimming Ballast

6" Universal Compact Fluorescent Trims (2) Vertical PI Lamps

EL 12W
EL 12SH

NEW!

Albalite Shower Trim
Lamp: 2-13W-Quad
O.D.: 8"



ELA 85SW
ELA 85SB
ELA 85SC
ELA 85SG

Wall Wash with Reflector
Lamp: 2-13W-Quad
O.D.: 7 1/4"



EL 13W
EL 13SH

Fresnel Shower Trim
Lamp: 2-13W-Quad
O.D.: 8"



ELA 88SC
ELA 88SB
ELA 88SG
ELA 88SW

Reflector Trim
Lamp: 2-13W-Quad
O.D.: 7 1/4"



EL 16W
EL 16SH

Drop Opal Shower Trim
Lamp: 2-13W-Quad
O.D.: 8"



ELM 42BZ

Baffle with
Albalite Lens
Lamp: 2-13W-Quad
O.D.: 7 1/4"

NEW!



ELA 102B
ELA 102N
ELA 102W

Baffle with Reflector
Lamp: 2-13W-Quad
O.D.: 7 1/4"



ELM 42CP

Baffle with
Albalite Lens
Lamp: 2-13W-Quad
O.D.: 7 1/4"

NEW!



NEW!
ELA 102BZ

Baffle with Reflector
Lamp: 2-13W-Quad
O.D.: 7 1/4"



ELM 42W
ELM 42B

Baffle with
Albalite Lens
Lamp: 2-13W-Quad
O.D.: 7 1/4"



NEW!
ELA 102CP

Baffle with Reflector
Lamp: 2-13W-Quad
O.D.: 7 1/4"



ELM 46W
ELM 46B

Stepped Baffle with
Regressed Drop Opal Lens
Lamp: 2-13W-Quad
O.D.: 7 1/4"



ELM 205W
ELM 205B

Wall Wash with Baffle
and Reflector Trim
Lamp: 2-13W-Quad
O.D.: 7 1/4"



ELS 42C
ELS 42B
ELS 42G
ELS 42W

Reflector with Albalite Lens
Lamp: 2-13W-Quad
O.D.: 7 1/4"



6" Compact Fluorescent Sloped Ceiling Vertical Downlight

- 6" Architectural sloped compact fluorescent vertical downlight.
- For use with one or two compact fluorescent lamps.
- U.L. listed for damp location and through branch wiring.
- IC housings for use in insulated ceilings
- IC Airtight housings meet CA Title24 Requirements (Per ASTM E283 standards)



6"

EL 642G, EL 642B, EL 642C, EL 642W

Regressed Lens
Lamp: 26W Triple Max
O.D.: 8"



EL 622W, EL 622B, EL 622KB, EL 622KW

Sloped Phenolic Baffle
O.D.: 7 1/2"



EL 12W, EL 12SH, EL 12BZ, EL 12CP

Shower Trim with Albalite Lens
O.D.: 8"



EL 13W, EL 13SH, EL 13BZ, EL 13CP

Shower Trim with Fresnel Lens
O.D.: 8"



EL 616G, EL 616B, EL 616C, EL 616W, EL 616 KC

Specular Reflector
O.D.: 7 1/2" x 8"



NEW!

Opening:
6 1/2" x 6 3/4"
Trim O.D.: 7 1/2"

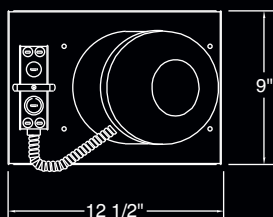
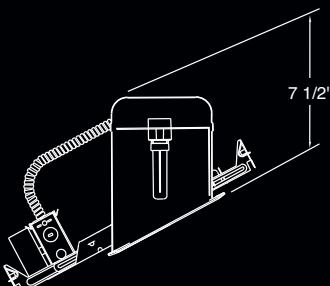

T24 EL 613
EL 6113E
EL 6113ICEA

- (1) 13W 2 Pin Quad 120V N.P.F. Ballast
- (1) 13W 2 Pin Quad 120/277V H.P.F. Electronic Ballast
- (1) 13W 4 Pin PL lamp 120V Electronic Ballast, IC Airtight, CA. Title 24 with ENERGY STAR qualified ballast
- (1) 13W 4 Pin PL lamp 120/277V Dimmable Electronic Ballast, IC Airtight, CA. Title 24

T24 EL 6113ICDA

T24 EL 6118E
EL 6118ICEA

- (1) 18W 4 Pin Quad 120/277V Electronic Ballast
- (1) 18W 4 Pin PL lamp 120V Electronic Ballast, IC Airtight, CA. Title 24 with ENERGY STAR qualified ballast
- (1) 18W 4 Pin PL lamp 120/277V Dimmable Electronic Ballast, CA. Title 24 IC Airtight

T24 EL 6118ICDA

EL 6213
EL 6213E

- (2) 13W 2 Pin Quad 120V N.P.F. Ballast
- (2) 13W 4 Pin Quad 120/277V Electronic Ballast

T24 EL 6126E
EL 6126D
EL 6126ICEA

- (1) 26W 4 Pin PL-T/26 120/277V H.P.F. Electronic Ballast
- (1) 26W 4 Pin PL-T/26 120/277V H.P.F. Dimmable Ballast
- (1) 26W 4 Pin PL lamp 120V Electronic Ballast, IC Airtight, CA. Title 24 with ENERGY STAR qualified ballast
- (1) 26W 4 Pin PL lamp 120/277V Dimmable Electronic Ballast, CA. Title 24 IC Airtight

T24 EL 6126ICDA

T24 EL 6126ICD1A

- (1) 26W 4 Pin Quad/Triple, 120V, Dimmable N.P.F. Ballast IC, Airtight, CA. Title 24, with ENERGY STAR qualified ballast

EL 6132E
EL 6132D
EL 6132DX

- (1) 32W 4 Pin PL-T/32 120/277V H.P.F. Electronic Ballast
- (1) 32W 4 Pin PL-T/32 120/277V H.P.F. Dimmable Ballast
- (1) 32W 4 Pin PL-T/32 120V Dimmable with Mark X Ballast

EL 6142E
EL 6142D
EL 6142DX

- (1) 42W 4 Pin PL-T/42 120/277V H.P.F. Electronic Ballast
- (1) 42W 4 Pin PL-T/42 120/277V H.P.F. Dimmable Ballast
- (1) 42W 4 Pin Triple, 120V, Dimmable Mark X Ballast

6" Architectural Sloped Compact Fluorescent Vertical Remodel Downlight

- 6" Architectural sloped compact fluorescent vertical remodel downlight with thermal protector.
- For use with one or two compact fluorescent lamps.
- U.L. listed for damp location and branch wiring.
- IC housings for use in insulated ceilings
- IC Airtight housings meet CA Title24 Requirements (Per ASTM E283 standards)



6"

EL 642G, EL 642B, EL 642C, EL 642W
 Regressed Lens
 Lamp: 26W Triple Max
 O.D.: 8"



EL 622W, EL 622B, EL 622KW
 Sloped Phenolic Baffle
 O.D.: 7 1/2"



EL 12W, EL 12BZ, EL 12CP, EL 12SH
 Shower Trim with Albalite Lens
 O.D.: 8"



EL 13W, EL 13BZ, EL 13CP, EL 13SH
 Shower Trim with Fresnel Lens
 O.D.: 8"







EL 616G, EL 616B, EL 616C, EL 616W, EL 616KC
 Specular Reflector
 O.D.: 7 1/2" x 8"



NEW!

- | | | |
|-------------------------------------------------------------------------------------|---------------------|-------------------------------------------------------------------------------------------------------------|
|  | EL 613R | (1) 13W 2 Pin Quad 120V N.P.F. Ballast |
|  | EL 6113RE | (1) 13W 4 Pin Quad 120/277V H.P.F. Electronic Ballast |
|  | EL 6113RICEA | (1) 13W 4 Pin PL lamp 120V Electronic Ballast, IC Airtight, CA. Title 24 with ENERGY STAR qualified ballast |
|  | EL 6113RICDA | (1) 13W 4 Pin PL lamp 120/277V Dimmable Ballast, IC Airtight, CA. Title 24 |



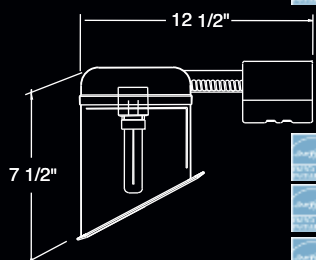

Opening: 6 1/2" x 6 3/4"
 Trim O.D.: 7 1/2"

- | | | |
|-------------------------------------------------------------------------------------|---------------------|-------------------------------------------------------------------------------------------------------------|
|  | EL 6213R | (2) 13W 2 Pin Quad 120V N.P.F. Ballast |
|  | EL 6213RE | (2) 13W 4 Pin Quad 120/277V Electronic Ballast |
|  | EL 6118RE | (1) 18W 4 Pin Quad 120/277V H.P.F. Electronic Ballast |
|  | EL 6118RICEA | (1) 18W 4 Pin PL lamp 120V Electronic Ballast, IC Airtight, CA. Title 24 with ENERGY STAR qualified ballast |
|  | EL 6118RICDA | (1) 18W 4 Pin PL lamp 120/277V Dimmable Ballast, IC Airtight, CA. Title 24 |



- | | | |
|-------------------------------------------------------------------------------------|----------------------|---------------------------------------------------------------------------------------------------------------|
|  | EL 6126RE | (1) 26W 4 Pin PL-T/26 120/277V H.P.F. Electronic Ballast |
|  | EL 6126RD | (1) 26W 4 Pin PL-T/26 120/277V H.P.F. Dimmable Ballast |
|  | EL 6126RDX | (1) 26W 4 Pin PL-T/26 120V Dimmable with Mark X Ballast |
|  | EL 6126RICEA | (1) 26W 4 Pin PL lamp 120V Electronic Ballast, IC Airtight, CA. Title 24 with ENERGY STAR qualified ballast |
|  | EL 6126RICDA | (1) 26W 4 Pin PL lamp 120/277V Dimmable Ballast, IC Airtight, CA. Title 24 |
|  | EL 6126RICD1A | (1) 26W 4 Pin PL lamp 120/277V Dimmable Ballast, IC Airtight, CA. Title 24 with ENERGY STAR qualified ballast |



- | | | |
|-------------------------------------------------------------------------------------|-------------------|----------------------------------------------------------|
|  | EL 6132RE | (1) 32W 4 Pin PL-T/32 120/277V H.P.F. Electronic Ballast |
|  | EL 6132RD | (1) 32W 4 Pin PL-T/32 120/277V H.P.F. Dimmable Ballast |
|  | EL 6142RE | (1) 42W 4 Pin PL-T/42 120/277V H.P.F. Electronic Ballast |
|  | EL 6142RD | (1) 42W 4 Pin PL-T/42 120/277V H.P.F. Dimmable Ballast |
|  | EL 6142RDX | (1) 42W 4 Pin Triple, 120V, Dimmable Mark X Ballast |

5" Universal Compact Fluorescent Downlight

- Integral ballast for one compact fluorescent lamp.
- 7 1/2" height allows for use in 2 x 8 construction.
- Housing adjusts 1 3/8" to accommodate different ceiling thicknesses.
- Captive bar hangers span 24" joists and can be repositioned at 90°.
- Thermally protected ballast.
- U.L. damp location listed.
- U.L. feed through listed.



5"

Height: 7 1/2"
Opening: 5 1/2"
Trim O.D.: 6 1/4"

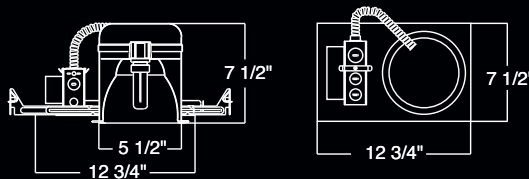

	EL 527HE13	(1) 13W 4 Pin Quad/TRT 120/277V Electronic Ballast
	EL 527HE18	(1) 18W 4 Pin PL-T/18 120/277V H.P.F Electronic Ballast
	EL 527H18D	(1) 18W 4 Pin PL-T/18 120/277V H.P.F Electronic Dimming Ballast
NEW!	EL 527H18DX	(1) 18W 4 Pin PL-T/18 120V Dimming with Mark X Ballast
	EL 527HE26	(1) 26W 4 Pin PL-T/26 120/277V H.P.F Electronic Ballast
	EL 527H26D	(1) 26W 4 Pin PL-T/26 120/277V H.P.F Electronic Dimming Ballast
NEW!	EL 527H26DX	(1) 26W 4 Pin PL-T/26 120/277V H.P.F Electronic Dimming Ballast
	EL 527HE32	(1) 32W 4 Pin PL-T/32 120/277V H.P.F Electronic Ballast
	EL 527H32D	(1) 32W 4 Pin PL-T/32 120/277V H.P.F Electronic Dimming Ballast
NEW!	EL 527H32DX	(1) 32W 4 Pin PL-T/32 120V Dimming with Mark X Ballast
	EL 527HE42	(1) 42W 4 Pin PL-T/42 120/277V H.P.F Electronic Ballast
	EL 527H42D	(1) 42W 4 Pin PL-T/42 120/277V H.P.F Electronic Dimming Ballast
NEW!	EL 527H42DX	(1) 42W 4Pin PI-T 120V Dimming Ballast (2 wire)

5" Universal Compact Fluorescent

- Integral ballast for one compact fluorescent lamp.
- 7 1/2" height allows for use in 2 x 8 construction.
- Housing adjusts 1 3/8" to accommodate different ceiling thicknesses.
- Captive bar hangers span 24" joists and can be repositioned at 90°.
- Thermally protected ballast.
- U.L. damp location listed.
- U.L. feed through listed.
- IC Housing for use in insulated ceiling
- IC Airtight electronic housings meet CA Title24 requirements (Per ASTM E283 standards)







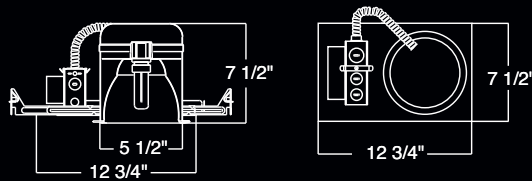



5"

Height: 7 1/2"
Opening: 5 1/2"
Trim O.D.: 6 1/4"



NEW!

	EL 527HICA	(1) 13W 2 Pin L/Quad, 120V N.P.F. Ballast, IC Airtight
	EL 527HE13IC	(1) 13W 4 Pin Quad/TRT 120/277V Electronic Ballast, IC
	EL 527HE13ICA	(1) 13W 4 Pin Quad, 120V Electronic Ballast, IC Airtight, with ENERGY STAR qualified ballast
	EL 527HE18IC	(1) 18W 4 Pin PL-T/18 120/277V H.P.F Electronic Ballast, IC
	EL 527H18ICDX	(1) 18W 4 Pin PL-T 120V Dimmable with Mark X Ballast, IC Airtight
	EL 527HE18ICA	(1) 18W 4Pin Quad 120V Electronic Ballast, IC Airtight, with ENERGY STAR qualified ballast
	EL 57H18ICD1A	(1) 18W 4 Pin Quad/Triple, 120V, Dimmable N.P.F. Ballast IC Airtight, CA. Title 24, with ENERGY STAR qualified ballast
	EL 527HE26ICA	(1) 26W 4 Pin 120V Electronic Ballast, IC Airtight, with ENERGY STAR qualified ballast
	EL 527HE26IC	(1) 26W 4 Pin 120/277V Electronic Ballast, IC
	EL 527H26ICDA	(1) 26W 4 Pin Quad, PL-T 120/277V Dimming Ballast, IC Airtight, CA.Title 24
	EL 527H26ICDX	(1) 26W 4 Pin PL-T 120V Dimmable with Mark X Ballast, IC Airtight, CA.Title 24
	EL 57H26ICD1A	(1) 26W 4 Pin Quad/Triple, 120V, Dimmable N.P.F. Ballast IC, Airtight, CA. Title 24, with ENERGY STAR qualified ballast

5" Compact Fluorescent Vertical Downlight, Electronic IC, 32W, 42W

- Integral electronic ballast for one compact fluorescent lamp.
- Housing adjusts 1 3/8" to accommodate different ceiling thickness.
- Supplied with captive hanger bars for 24" joist spacing.
- 7 1/4" Height allows for use in 2 x 8 construction.
- Feed through junction box.
- U.L. damp location listed.
- For use in insulated ceilings
- Airtight housings meet CA Title24 requirements (Per ASTM E283 standards)

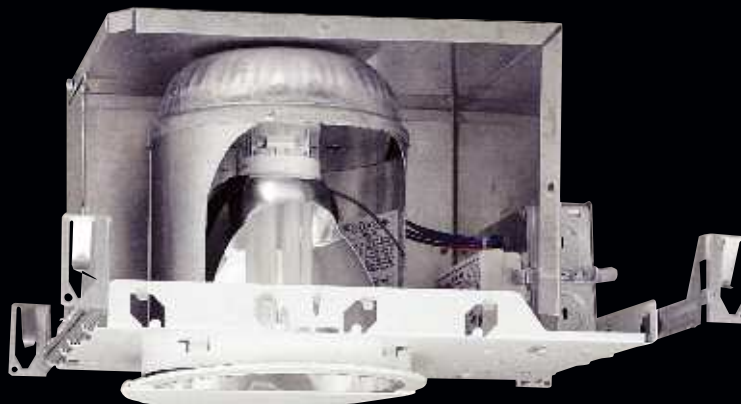

5"

Height: 7 1/4"
 Opening: 5 1/2"
 Trim O.D.: 6 1/4"

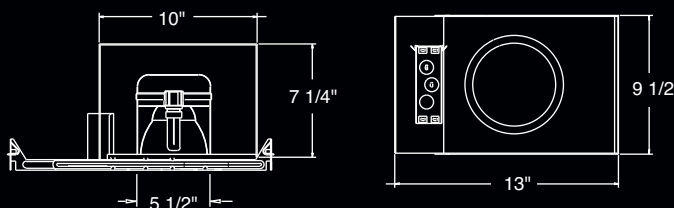

NEW!

	T24 EL 527HE32ICA	(1) 32W 4 Pin Triple Biax 120/277V H.P.F Ballast, IC Airtight
	T24 EL 527H32ICDA	(1) 32W 4 Pin Triple Biax 120/277V Dimming Ballast, IC Airtight
	T24 EL 527H32ICDXA	(1) 32W 4 Pin Triple Biax 120V, Mark X Dimmable Ballast, IC Airtight
<hr/>		
	T24 EL 527HE42ICA	(1) 42W 4 Pin, 120/277V Electronic Ballast, IC Airtight
	T24 EL 527H42ICDA	(1) 42W 4 Pin, 120/277V Dimmable Ballast, IC Airtight
	T24 EL 527H42ICDXA	(1) 42W 4 Pin Triple Biax 120V, Mark X Dimmable Ballast, IC Airtight

5" Compact Fluorescent Remodel Housing

- 5" Remodel Housing for 1 Vertical Compact Fluorescent Lamp.
- 7 1/2" Height allows for use in 2 x3 construction Thermally Protected Ballast.
- Thermally Protected Ballast
- IC Airtight Electronic housing meet CA Title 24 and IECC requirements.
- IC Housing for use in insulated ceiling.
- U.L. damp location listed
- U.L. feed through listed



5"

Height: 7 1/2"
Opening: 5 1/2"
Trim O.D.: 6 1/4"

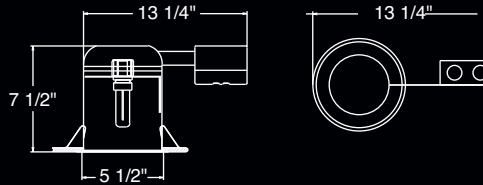

NEW!

	EL 527RHICA	(1) 13W 2 Pin Quad, 120V N.P.F. Ballast, IC Airtight
	EL 527RHE13	(1) 13W 4 Pin Quad/Triple 120/277V Electronic Ballast
	EL 527RE13ICA	(1) 13W 4 Pin 120V Electronic Ballast, Meet CA Title 24 code, with ENERGY STAR qualified ballast
	EL 527RHE18	(1) 18W 4 Pin Quad 120/277V Electronic Ballast
	EL 527RE18ICA	(1) 18W 4 Pin 120V Electronic IC Airtight, Meet CA Title 24 code, with ENERGY STAR qualified ballast
	EL 57R18ICD1A	(1) 18W 4 Pin 120V Dimmable N.P.F. Ballast, IC Airtight, CA. Title 24 , with ENERGY STAR qualified ballast
	EL 527RH18D	(1) 18W 4 Pin Quad 120/277V Dimmable
	EL 527RH18DX	(1) 18W 4 Pin Quad 120V Dimmable Mark X Ballast
	EL 527RH18DX-7	(1) 18W 4 Pin Quad 277V Dimmable Mark X Ballast
	EL 527RHE26	(1) 26W 4 Pin PL-T/26 120/277V Electronic Ballast
	EL 527RH26D	(1) 26W 4 Pin PL-T/26 120/277V Dimmable
	EL 527RH26DX	(1) 26W 4 Pin Quad, Triple, 120V, Dimmable Mark X Ballast
	EL 527RH126DX-7	(1) 26W 4 Pin Quad 277V Dimmable Mark X Ballast
	EL 527RE26ICA	(1) 26W 4 Pin 120V Electronic Ballast, IC Airtight, with ENERGY STAR qualified ballast
	EL 527R26ICDA	(1) 26W 4 Pin 120/277V Dimmable, IC Airtight
	EL 57R26ICD1A	(1) 26W 4 Pin 120V Dimmable N.P.F. Ballast, IC Airtight, CA. Title 24 , with ENERGY STAR qualified ballast
	EL 527RHE32	(1) 32W 4 Pin PL-T/32 120/277V Electronic Ballast
	EL 527RH32D	(1) 32W 4 Pin PL-T/32 120/277V Dimmable
	EL 527RH32DX	(1) 32W 4 Pin Triple 120V Dimmable Mark X Ballast
	EL 527RH32DX-7	(1) 32W 4 Pin Triple 277V Dimmable Mark X Ballast
	EL 527RHE42	(1) 42/32/26W 4 Pin PL-T 120/277V Electronic Ballast
	EL 527RH42D	(1) 42/32/26W 4 Pin PL-T 120/277V Dimmable
	EL 527RH42DX	(1) 42W 4 Pin Triple 120V Dimmable Mark X Ballast
	EL 527RH42DX-7	(1) 42W 4 Pin Triple 277V Dimmable Mark X Ballast

5" Compact Fluorescent Trims

EL 512W

EL 512N

EL 512SH

Albalite Shower Trim
Lamp: 42W Max CFL
O.D.: 6 1/4"



EL 5112W

Shower Trim with Albalite Lens
and Reflector
Lamp: 42W MAX CFL
O.D.: 6 1/4"



EL 513W

EL 513SH

Fresnel Lens
Shower Trim
Lamp: 42W Max CFL
O.D.: 6 1/4"



EL 5113W

Shower Trim with
Fresnel Lens and
Reflector
Lamp: 42W Max CFL
O.D.: 6 1/4"



EL 516W

EL 516SH

Drop Opal Shower Trim
Lamp: 42W Max CFL
O.D.: 6 1/4"



EL 5116W

Drop Opal
Lens with Reflector
Lamp: 42W Max CFL
O.D.: 6 1/4"

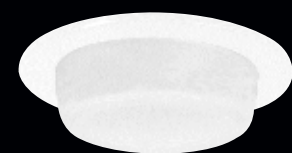

EL 542B

EL 542W

Regressed
Albalite Lens with Baffle
Lamp: 26W Triple Max CFL
O.D.: 6 1/4"



EL 546B

Baffle with
Regressed Drop Opal Lens
Lamp: 42W Max CFL
O.D.: 6 1/4"



EL 546W

Baffle with
Regressed Drop Opal Lens
Lamp: 42W Max CFL
O.D.: 6 1/4"



EL 501B

Black Baffle
with Reflector
Lamp: 42W Max CFL
O.D.: 6 1/4"



EL 501W

Baffle with Reflector
Lamp: 42W Max CFL
O.D.: 6 1/4"



ELA 599SC

ELA 599SB

Reflector Trim
Lamp: 42W Max CFL
O.D.: 6 1/4"



ELA 599SG

Gold Reflector Trim
Lamp: 42W Max CFL
O.D.: 6 1/4"



ELA 599SW

White Reflector Trim
Lamp: 42W Max CFL
O.D.: 6 1/4"



ELM 530B

ELM 530N

ELM 530W

Metal Baffle Trim
Lamp: 42W Max CFL
O.D.: 6 1/4"



ELP 530B

ELP 530W

Phenolic Baffle Trim
Lamp: 42W Max CFL
O.D.: 6 1/4"

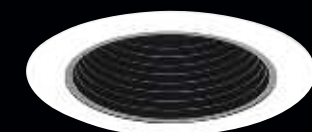

ELS 542C

ELS 542B

ELS 542G

ELS 542W

Reflector with
Regressed Albalite Lens
Lamp: 26W Triple Max CFL
O.D.: 6 1/4"



ELM 5045B

ELM 5045W

Wall Wash Baffle with
Socket Bracket
Lamp: 26W Triple Max CFL
O.D.: 6 1/4"

NEW!

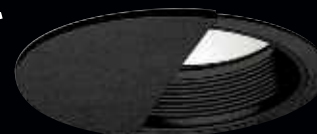



4" Architectural Vertical Compact Fluorescent Downlights

- A compact fluorescent housing designed for one 13W, 18W or 26W Triple Biax compact fluorescent lamp.
- Thermally protected ballast
- 6 1/2" Height
- U.L. damp location listed.
- U.L. feed through listed.



4"

Height: 6 1/2"
 Ceiling Opening: 4 3/8"
 Trim O.D.: 4 3/4"

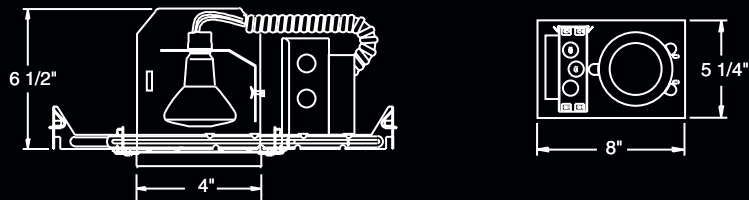

ELV 4113E	(1) 13W 4 Pin Triple Biax 120/277V H.P.F. Electronic Ballast
ELV 4113E-347	(1) 13W 4 Pin Triple Biax 347V H.P.F. Electronic Ballast
ELV 4118E	(1) 18W 4 Pin Triple Biax 120/277V H.P.F. Electronic Ballast
ELV 4118D	(1) 18W 4 Pin PL-T 120/277V Dimmable Ballast
ELV 4118DX	(1) 18W 4 Pin PL-T 120V Mark X Dimmable Ballast
ELV 4118E-347	(1) 18W 4 Pin Triple Biax 347V H.P.F. Electronic Ballast
ELV 4126E	(1) 26W 4 Pin PL-T 120/277V Electronic Ballast
ELV 4126D	(1) 26W 4 Pin PL-T 120/277V Dimmable Ballast
ELV 4126DX	(1) 42W 4 Pin PL-T 120V Mark X Dimmable Ballast
ELV 4132E	(1) 32W 4 Pin PL-T 120/277V Electronic Ballast
ELV 4132D	(1) 32W 4 Pin PL-T 120/277V Dimmable Ballast
ELV 4132DX	(1) 32W 4 Pin PL-T 120V Mark X Dimmable Ballast

4" Compact Fluorescent Downlight (13W)

- Miniature compact fluorescent with class P thermally protected ballast.
- EL99PLICEA meets CA. Title 24 Code for direct contact with insulation
- Junction box is listed for through branch circuit wiring featuring 1/2" knockouts with true pryout slots.
- Housing can be removed from plaster frame for junction box access.
- Captive hanger bars will span 24" joists spacing.
- 5 1/2" height allows installation in 2 x 6 construction.
- U.L. listed.



4"

Height: 5 1/2"
 Ceiling Opening: 4 3/8"
 Trim O.D.: 4 3/4"

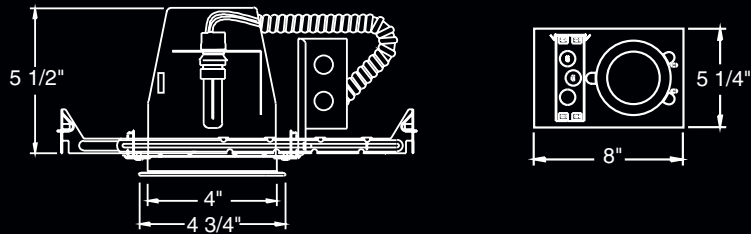

NEW!



T24

EL 99PL
 EL 99PLE
 EL 99PLICEA

- (1) 13W 2 Pin Quad 120V N.P.F. Ballast
- (1) 13W 4 Pin Triple Biax 120/277V H.P.F. Electronic Ballast
- (1) 13W 4 Pin Triple, 120V Electronic ballast, IC Airtight, Title 24 Compliant, with ENERGY STAR qualified ballast

4" IC Airtight Compact Fluorescent Downlight

- Miniature compact fluorescent with class P thermally protected ballast.
- For use in insulated ceilings, IC housing
- Meet Title 24 requirements, Airtight with gasket on frame (Per ASTM E283 standards)
- Double wall construction housings
- Junction box is listed for through branch circuit wiring featuring 1/2" knockouts with true pryout slots.
- Housing can be removed from plaster frame for junction box access.
- Captive hanger bars will span 24" joists spacing.
- 5 1/2" height allows installation in 2 x 6 construction.
- Design for (1) triple tube Compact Fluorescent Lamp
- U.L. damp location listed
- U.L. feed through listed

NEW!



4"

Height: 5 1/2"
Ceiling Opening: 4 3/8"
Trim O.D.: 4 3/4"

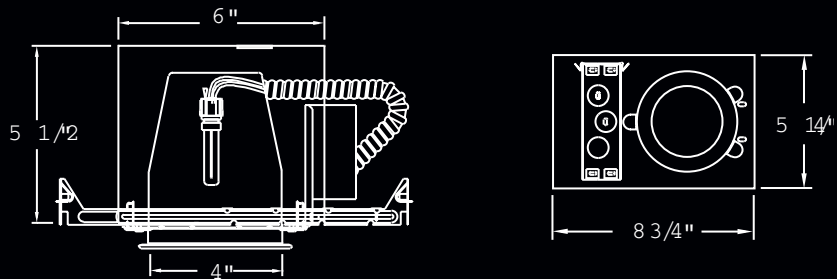

NEW!

- T24** EL 99PL18ICEA (1) 18W 4 Pin Triple lamp, 120V Electronic Ballast, IC Airtight, with ENERGY STAR qualified ballast
- T24** EL 99PL18ICDA (1) 18W 4 Pin Triple lamp, 120/277 Electronic Dimmable Ballast, IC Airtight
- T24** EL 99PL18ICDXA (1) 18W, 4 Pin Triple Lamp, 120V, Mark X Dimming Ballast, IC Airtight, CA.
- T24** Title 24
EL 99PL18ICD1A (1) 18W, 4 Pin Triple Lamp, 120V Dimming Ballast, IC Airtight, CA. Title 24, with ENERGY STAR qualified ballast
- T24** EL 99PL26ICEA (1) 26W 4 Pin Triple lamp, 120V Electronic Ballast, IC Airtight
- T24** EL 99PL26ICDA (1) 26W 4 Pin Triple lamp, 120/277 Electronic Dimmable Ballast, IC Airtight
- T24** EL 99PL26ICDXA (1) 26W, 4 Pin Triple Lamp, 120V, Mark X Dimming Ballast, IC Airtight, CA. Title 24
- T24** EL 99PL26ICD1A (1) 26W, 4 Pin Triple Lamp, 120V Dimming Ballast, IC Airtight, CA. Title 24,

4" Energy Efficient Remodel Compact Fluorescent Vertical Downlight (13W)

- Energy efficient miniature compact fluorescent 4" remodel housing.
- Thermally protected "Class P" ballast
- Junction box is listed for through branch circuit wiring featuring 1/2" knockouts with true pryout slots.
- Housing can be removed from ceiling for junction box access.
- 5 1/2" Height allows installation in 2 x 6 construction.
(For 13W units)
- UL Listed.
- EL 99RPLICEA, Airtight housing meet CA. Title 24 Code requirements (for direct contact with insulation, Airtight)



4"

Height: 5 1/2"
Ceiling Opening: 4 3/8"
Trim O.D.: 4 3/4"

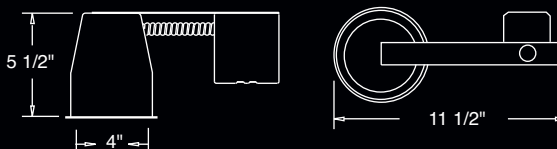

NEW!

EL 99RPL (1) 13W 2 Pin Lamp 120V N.P.F. Magnetic Ballast N.P.F.

EL 99RPLE (1) 13W 4 Pin Lamp 120/277V H.P.F. Electronic Ballast



T24

EL 99RPLICEA (1) 13W 4 Pin Lamp 120V Electronic Ballast IC Airtight housing, CA. Title 24 Compliant, with ENERGY STAR qualified ballast

4" Energy Efficient Remodel Compact Fluorescent Vertical Downlight (18-32W)

- Energy efficient miniature compact fluorescent 4" remodel housing.
- Thermally protected "Class P" ballast
- Junction box is listed for through branch circuit wiring featuring 1/2" knockouts with true pryout slots.
- Housing can be removed from ceiling for junction box access.
- 6 1/2" Height
- UL Listed.

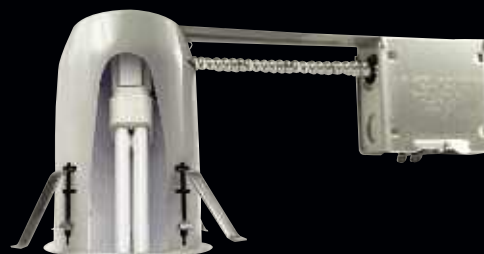

4"

Height: 6 1/2"
Ceiling Opening: 4 3/8"
Trim O.D.: 4 3/4"

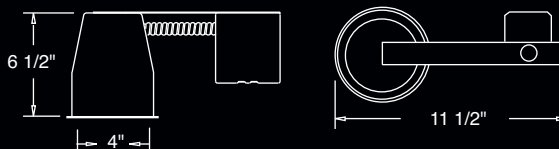

NEW!



T24

EL 99RPL18EA (1) 18W 4 Pin Lamp 120/277V H.P.F. Electronic Ballast, Airtight Housing
EL 99RPL18ICEA (1) 18W 4 Pin Lamp 120V Electronic Ballast IC Airtight Housing, CA. Title 24

with ENERGY STAR qualified ballast

EL 99RPL16DXA (1) 16W 4 Pin Triple Lamp 120V Mark X Dimmable Ballast, Airtight Housing

EL 99RPL26EA (1) 26W 4 Pin Lamp 120/277V H.P.F. Electronic Ballast, Airtight Housing

EL 99RPL26DA (1) 26W 4 Pin Lamp 120/277V Dimmable Ballast, Airtight Housing

EL 99RPL26DXA (1) 26W 4 Pin Triple Lamp, 120V Mark X Dimmable Ballast, Airtight Housing

EL 99RPL32EA (1) 32W 4 Pin Triple Lamp 120/277V Electronic Ballast, Airtight Housing

EL 99RPL32DA (1) 32W 4 Pin Triple Lamp 120/277V Dimmable Ballast, Airtight Housing

4" Compact Fluorescent Trims

EL 9111W

Shower Trim with Reflector and Clear Lens
Lamp: 32W Max CFL (PL-T)
O.D.: 4 3/4"

NEW!



EL 9115BZ

Shower Trim with Reflector and Frosted Pinhole Glass Lens
Lamp: 32W Max CFL (PL-T)
O.D.: 4 3/4"

NEW!



EL 9112W

EL 9112B

EL 9112C

EL 9112G

Shower Trim with Reflector and Frosted Lens
Lamp: 32W Max CFL (PL-T)
O.D.: 4 3/4"



EL 9115CP

Shower Trim with Reflector and Frosted Pinhole Glass Lens
Lamp: 32W Max CFL (PL-T)
O.D.: 4 3/4"

NEW!



EL 9112BZ

Shower Trim with Frosted Lens and Reflector
Lamp: 32W Max CFL (PL-T)
O.D.: 4 3/4"

NEW!



EL 9116G

Shower Trim with Reflector and Drop Opal Lens
Lamp: 32W Max CFL (PL-T)
O.D.: 4 3/4"

EL 9116W



EL 9112CP

Shower Trim with Frosted Lens and Reflector
Lamp: 32W Max CFL (PL-T)
O.D.: 4 3/4"

NEW!



EL 9116BZ

Shower Trim with Reflector and Drop Opal Lens
Lamp: 32W Max CFL (PL-T)
O.D.: 4 3/4"

NEW!



EL 9113W

EL 9113G

Shower Trim Reflector and Fresnel Lens
Lamp: 32W Max CFL (PL-T)
O.D.: 4 3/4"



EL 9116CP

Shower Trim with Reflector and Drop Opal Lens
Lamp: 32W Max CFL (PL-T)
O.D.: 4 3/4"

NEW!



EL 9113BZ

Shower Trim Reflector and Fresnel Lens
Lamp: 32W Max CFL (PL-T)
O.D.: 4 3/4"

NEW!



EL 911W

Shower Trim with Clear Lens
Lamp: 32W Max CFL (PL-T)
O.D.: 4 3/4"



EL 9113CP

Shower Trim Reflector and Fresnel Lens
Lamp: 32W Max CFL (PL-T)
O.D.: 4 3/4"

NEW!



EL 911BZ

Shower Trim with Clear Lens
Lamp: 32W Max CFL (PL-T)
O.D.: 4 3/4"

NEW!



EL 9115W

Shower Trim with Reflector and Frosted Pinhole Glass Lens
Lamp: 32W Max CFL (PL-T)
O.D.: 4 3/4"



EL 911CP

Shower Trim with Clear Lens
Lamp: 32W Max CFL (PL-T)
O.D.: 4 3/4"

NEW!



4" Compact Fluorescent Trims (Cont.)

EL 912N
EL 912B
EL 912C
EL 912G
EL 912W

Shower Trim
with Frosted Lens
Lamp: 32W Max CFL (PL-T)
O.D.: 4 3/4"



EL 914CP

Shower Trim
with Albalite Lens
Lamp: 32W Max CFL (PL-T)
O.D.: 4 3/4"

NEW!



EL 912BZ

Shower Trim
with Frosted Lens
Lamp: 32W Max CFL (PL-T)
O.D.: 4 3/4"

NEW!



EL 915W

EL 915B

EL 915C

EL 915G

EL 915N

Shower Trim with
Frosted Pinhole Glass
Lamp: 32W Max CFL (PL-T)
O.D.: 4 3/4"



EL 912CP

Shower Trim
with Frosted Lens
Lamp: 32W Max CFL (PL-T)
O.D.: 4 3/4"

NEW!



EL 915BZ

Shower Trim with
Frosted Pinhole Glass
Lamp: 32W Max CFL (PL-T)
O.D.: 4 3/4"

NEW!



EL 913W

EL 913G
Shower Trim
with Fresnel Lens
Lamp: 32W Max CFL (PL-T)
O.D.: 4 3/4"



EL 915CP

Shower Trim with
Frosted Pinhole Glass
Lamp: 32W Max CFL (PL-T)
O.D.: 4 3/4"

NEW!



EL 913BZ

Shower Trim
with Fresnel Lens
Lamp: 32W Max CFL (PL-T)
O.D.: 4 3/4"

NEW!



EL 916G

EL 916B

EL 916C

EL 916W

Shower Trim
with Drop Opal Lens
Lamp: 32W CFL (PL-T)
O.D.: 4 3/4"



EL 913CP

Shower Trim
with Fresnel Lens
Lamp: 32W Max CFL (PL-T)
O.D.: 4 3/4"

NEW!



EL 916BZ

Shower Trim
with Drop Opal Lens
Lamp: 32W CFL (PL-T)
O.D.: 4 3/4"

NEW!



EL 914W

EL 914B
Shower Trim
with Albalite Lens
Lamp: 32W Max CFL (PL-T)
O.D.: 4 3/4"



EL 914BZ

Shower Trim
with Albalite Lens
Lamp: 32W Max CFL (PL-T)
O.D.: 4 3/4"

NEW!



EL 916CP

Shower Trim
with Drop Opal Lens
Lamp: 32W CFL (PL-T)
O.D.: 4 3/4"

NEW!



4" Compact Fluorescent Trims (Cont.)

EL 925C

EL 925G

Wall Wash with Reflector
Lamp: 32W PAR 20 or R20
O.D.: 4 3/4"



EL 926N

EL 926B

EL 926C

EL 926G

EL 926W

Chrome Reflector with
Suspended Frosted Glass
Lamp: 32W CFL (PL-T)
O.D.: 4 3/4"



EL 926BZ

NEW!

Chrome Reflector
with Suspended
Frosted Lens, Bronze Ring
Lamp: 32W CFL (PL-T)
O.D.: 4 3/4"



EL 926CP

NEW!

Chrome Reflector
with Suspended
Frosted Lens, Copper Ring
Lamp: 32W CFL (PL-T)
O.D.: 4 3/4"



EL 952W

EL 952BL

EL 952R

Frosted Glass Trim
Lamp: 32W CFL (PL-T)
O.D.: 4 3/4"



EL 953BL

EL 953W

Blue Frosted
Stepped Glass Trim
Lamp: 32W CFL (PL-T)
O.D.: 4 3/4"



EL 992KW

Wall Wash Trim
with Bracket
Lamp: 32W CFL (PL-T)
O.D.: 4 3/4"



EL 993W

EL 993B

EL 993N

Phenolic Baffle Trim
Lamp: 32W Max CFL (PL-T)
O.D.: 4 3/4"



EL 993WBZ

NEW!

Phenolic Baffle
Lamp: 32W Max CFL (PL-T)
O.D.: 4 3/4"



EL 994W

Phenolic Baffle
Lamp: 32W Max CFL (PL-T)
O.D.: 4 3/4"



EL 993WCP

NEW!

Phenolic Baffle
Lamp: 32W Max CFL (PL-T)
O.D.: 4 3/4"



EL 999C

EL 999B

EL 999G

EL 999W

Reflector Trim
Lamp: 32W Max CFL (PL-T)
O.D.: 4 3/4"



EL 999GG

EL 999CC

Reflector Trim
Lamp: 32W Max CFL (PL-T)
O.D.: 4 3/4"



EL 999BZ

NEW!

Reflector Trim
Lamp: 32W Max CFL (PL-T)
O.D.: 4 3/4"



EL 999CP

NEW!

Reflector Trim
Lamp: 32W Max CFL (PL-T)
O.D.: 4 3/4"



EL 999DC

EL 999DG

Reflector Trim
with Diecast Ring
Lamp: 32W Max CFL (PL-T)
O.D.: 4 3/4"



ELA 499SC

Deep Cone Clear Reflector
Lamp: 32W Max CFL (PL-T)
O.D.: 4 3/4"



Commercial Retrofit

“We had four primary objectives...be within budget parameters, use existing dimming system, achieve acceptable light levels and reduce energy cost. We accomplished all four of them with the Elco products.”

Portland Marriott Hotel
Senior Engineer William Moore

The Elco Lighting Retrofit System is designed for easy install using a simple system of high-quality reflector and specialty trims, ballasts and mounting clips. Minimal tools are required since the system snaps easily into the existing downlight's mounting frame. Unlike typical residential retrofit systems, Elco's Commercial Retrofit System allows for easy lamp replacement because the ballast is permanently installed and separate from the lamp.

Elco Lighting's Commercial Retrofit System is safe, economical, environment-friendly and architecturally pleasing.

145-166

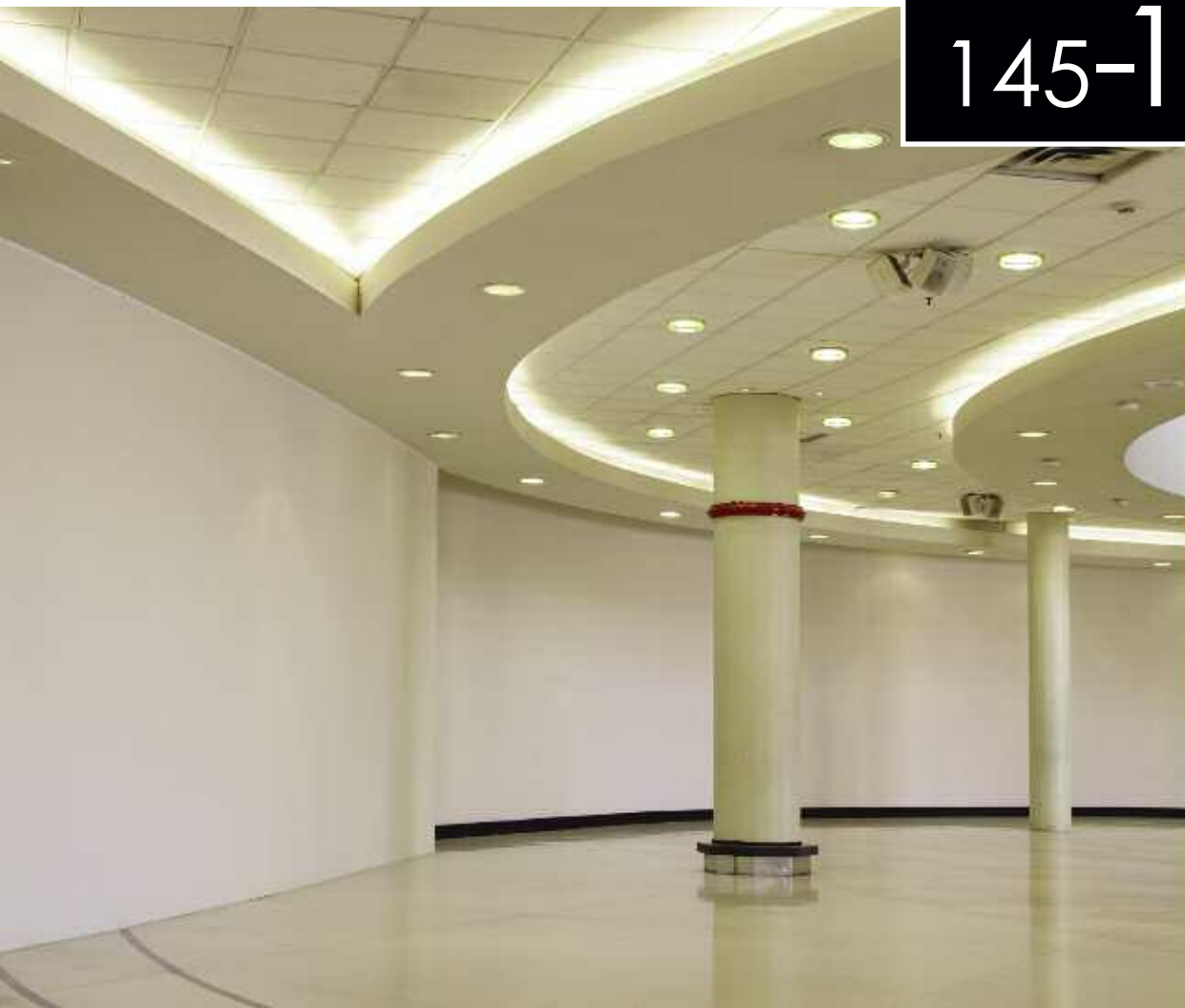

Be energy-efficient with **Elco Lighting's** Commercial Retrofit System

Change out wasteful incandescent fixtures to environment-friendly compact fluorescent to modernize hotels, airports, universities, business complexes, institutions and more!



Bronze and Copper

Bronze and Copper finish are now available on many of our wide selection of trims. Look for the product code of BZ (Bronze) and CP (Copper).



Ask your local Elco Lighting representative for Elco's new Commercial Retrofit Catalog

ELCO LIGHTING
2042 E. VERNON AVE
VERNON, CA 90058
Tel: 323-231-2600
Fax: 323-231-3200
www.elcolighting.com



The Best Choice in Lighting

"We beat their **quality, availability,** and of course their **price**"

Retrofit



Why Retrofit ?

Upgrading older, incandescent lighting fixtures with newer, compact fluorescent lighting increases visual comfort while costing an average of 50 to 75 percent less in energy use. Additional savings are often available through local utility rebate programs designed to encourage energy-saving retrofit projects. Compact fluorescent lamps are 4-5 times more efficient than incandescent lamps and last up to 10 times as long, and the cost of retrofitting is usually recuperated between 12 and 24 months from install. In a recent Elco retrofit project for the Marriott Hotel in downtown Portland, 250 twin 42-watt dimmable compact fluorescent lamps were used to replace 300-watt incandescent lamps, which doubled the light output at one-third the cost, reducing their energy use by 86%, based on lights under operation 12 hours per day, 365 days per year. In the energy-conscious environment we live in today, no one can afford to ignore results like these.

Other advantages include:

- Up to 80% reduction in lighting maintenance and re-lamping
- Savings of 10% to 30% in cooling costs due to reduced heat build up
- Longer system life cycle
- Added value through lower operating cost
- Eligibility for utility company rebates

9" Energy Efficient Architectural Compact Fluorescent Vertical



Height: 14"
 Ceiling Opening: 9 3/4" to 10 3/4"
 Trim O.D. : 11 1/4"

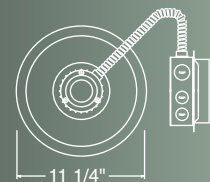
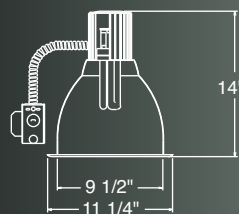

- Compact fluorescent retrofit kit for one (13W, 18W, 26W, 32W, 42W, 56W or 70W lamp).
- Trim support adjusts 3/4" to accommodate different ceiling thickness.
- U.L. damp location listed. U.L. feed through listed.
- Emergency battery back-up ballast (optional).
- Thermally protected "CLASS P" electronic ballast.

ERTV 9113E	(1) 13W 4 Pin Lamp 120/277V Electronic Ballast
ERTV 9118E	(1) 18W 4 Pin Lamp 120/277V Electronic Ballast
ERTV 9126E	(1) 26W 4 Pin Lamp 120/277V H.P.F Electronic Ballast
ERTV 9126D	(1) 26W 4 Pin Lamp 120/277V 0-10V Dimmable Ballast (4 wire)*
ERTV 9126DX	(1) 26W 4 Pin Lamp 120V Line Voltage Dimmable with Mark X Ballast (2 wire)†
ERTV 9126DX-7	(1) 26W 4 Pin Lamp 277V Line Voltage Dimmable Ballast (2 wire)†
NEW! ERTV 9132E	(1) 32W 4 Pin Lamp 120/277V H.P.F Electronic Ballast
ERTV 9132D	(1) 32W 4 Pin Lamp 120/277V 0-10V Dimmable Ballast (4 wire)*
ERTV 9132DX	(1) 32W 4 Pin Lamp 120V Line Voltage Dimmable with Mark X Ballast (2 wire)†
ERTV 9132DX-7	(1) 32W 4 Pin Lamp 277V Line Voltage Dimmable Ballast (2 wire)†
ERTV 9142E	(1) 42W 4 Pin Lamp 120/277V H.P.F Electronic Ballast
ERTV 9142D	(1) 42W 4 Pin Lamp 120/277V 0-10V Dimmable Ballast (4 wire)*
ERTV 9142DX	(1) 42W 4 Pin Lamp 120V Line Voltage Dimmable with Mark X Ballast (2 wire)†
ERTV 9142DX-7	(1) 42W 4 Pin Lamp 277V, Line Voltage Dimmable Ballast (2 wire)†
ERTV 9157E	(1) 57W 4 Pin Lamp 120/277V H.P.F Electronic Ballast
ERTV 9157D	(1) 57W 4 Pin Lamp 120/277V 0-10V Dimmable Ballast (4 wire)*
ERTV 9157DX	(1) 57W 4 Pin Lamp 120V Line Voltage Dimmable with Mark X Ballast (2 wire)†
ERTV 9157DX-7	(1) 57W 4 Pin Lamp 277V Line Voltage Dimmable Ballast (2 wire)†
ERTV 9170E	(1) 70W 4 Pin Lamp 120/277V H.P.F Electronic Ballast
ERTV 9170D	(1) 70W 4 Pin Lamp 120/277V 0-10V Electronic Dimmable Ballast (4 wire)*
ERTV 9170DX	(1) 70W 4 Pin Lamp 120V Line Voltage Dimmable with Mark X Ballast (2wire)†
ERTV 9170DX-7	(1) 70W 4 Pin Lamp 277V Line Voltage Dimmable Ballast (2 wire)†

EL 1016C
 Open Reflector
 O.D.: 11 1/4"



EL 1037C
 Reflector with Lens
 O.D.: 11 1/4"



347V electronic ballast available upon request
 * Advance Mark VII dimming ballast or similar
 † Advance Mark X dimming ballast or similar

• Other dimming ballast (Lutron) are available upon request at extra charge

8" Energy Efficient Achitectural Horizontal Compact Fluorescent Retrofit

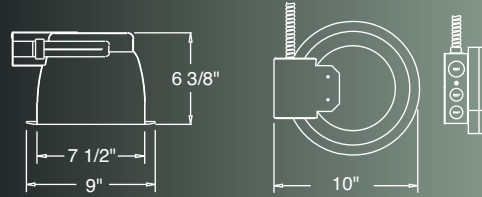

Height: 6 3/8"
 Ceiling Opening: 7 3/4" to 8 1/2"
 Trim O.D. : 9"

- Thermally protected magnetic fixtures are supplied with two single-lamp potted ballasts and may be wired for independent switching. Electronic units are supplied with one two-lamp ballast for 4 pin lamps.
- Junction box with 1/2" and 3/4" pryouts, listed for 8 #12 90°C conductors.
- U.L. listed
- Feed through junction box
- U.L. damp location listed
- Emergency battery back-up ballast (optional)

ERTH 8213E	(2) 13W 4 Pin Lamp 120/277V H.P.F. Electronic Ballast
ERTH 8213D	(2) 13W 4 Pin Lamp 120/277V 0-10V Dimmable Ballast (4 wire)*
ERTH 8218E	(2) 18W 4 Pin Lamp 120/277V H.P.F. Electronic Ballast
ERTH 8218D	(2) 18W 4 Pin Lamp 120/277V 0-10V Dimmable Ballast (4 wire)*
ERTH 8218DX	(2) 18W 4 Pin Lamp 120V Line Voltage Dimmable with Mark X Ballast (2 wire)†
ERTH 8218DX-7	(2) 18W 4 Pin Lamp 277V Line Voltage Dimmable Ballast (2 wire)†
ERTH 8126E	(1) 26W 4 Pin Lamp 120/277V Electronic Ballast
ERTH 8126D	(1) 26W 4 Pin Lamp 120/277V 0-10V Dimmable Ballast (4 wire)*
ERTH 8126DX	(1) 26W 4 Pin Lamp 120V Line Voltage Dimmable with Mark X Ballast (2 wire)†
ERTH 8126DX-7	(1) 26W 4 Pin Lamp 277V Line Voltage Dimmable Ballast (2 wire)†
ERTH 8226E	(2) 26W 4 Pin Lamp 120/277V H.P.F. Electronic Ballast
ERTH 8226D	(2) 26W 4 Pin Lamp 120/277V 0-10V Dimmable Ballast (4 wire)*
ERTH 8226DX	(2) 26W 4 Pin Lamp 120V Line Voltage Dimmable with Mark X Ballast (2 wire)†
ERTH 8226DX-7	(2) 26W 4 Pin Lamp 277V Line Voltage Dimmable Ballast (2 wire)†

EL 821G
 EL 821C
 EL 821F
 Reflector Trim
 O.D.: 9"



EL 842W
 EL 842B
 Baffle with
 Regressed Lens
 O.D.: 9"



EL 826C
 EL 826G
 Suspended Glass Trim
 with Clear Reflector
 O.D.: 9"



EL 862G
 EL 862C
 Reflector with
 Regressed Lens
 O.D.: 9"



EL 830B
 EL 830W
 Reflector
 with Baffle
 O.D.: 9"



EL 888C
 EL 888G
 Reflector with
 Cross Blades
 O.D.: 9"



8" Energy Efficient Compact Fluorescent Retrofit (32-42W Lamp)

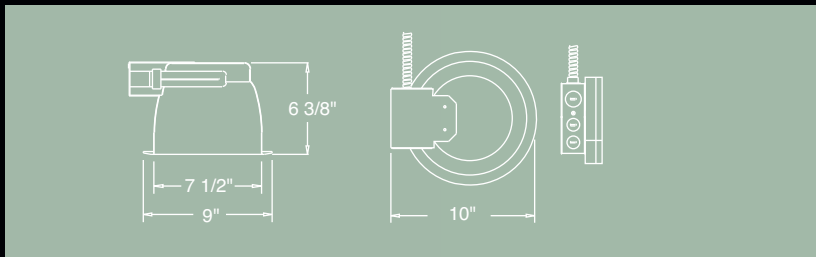

Height: 6 3/8"
 Ceiling Opening: 7 3/4" to 8 1/2"
 Trim O.D. : 9"

- Compact fluorescent retrofit kit, for one or two horizontally mounted lamps, with integral fluorescent electronic ballast for 4 pin compact fluorescent lamps.
- Trim support adjusts 3/4" to accommodate different ceiling thickness.
- 6 3/8" height allows use in 2 x 8 construction.
- Thermally protected "Class P", HPF electronic ballast (universal voltage).
- U.L. listed and U.L. damp location listed
- Feed through listed
- Emergency battery back-up ballast (optional)

ERTH 8132E	(1) 32W 4 Pin Lamp 120/277V H.P.F. Electronic Ballast
ERTH 8132D	(1) 32W 4 Pin Lamp 120/277V 0-10V Dimmable Ballast (4 wire)*
ERTH 8132DX	(1) 32W 4 Pin Lamp 120V Line Voltage Dimmable with Mark X Ballast (2 wire)†
ERTH 8132DX-7	(1) 32W 4 Pin Lamp 277V Line Voltage Dimmable Ballast (2 wire)†

ERTH 8232E	(2) 32W 4 Pin Lamp 120/277V H.P.F. Electronic Ballast
ERTH 8232D	(2) 32W 4 Pin Lamp 120/277V 0-10V Dimmable Ballast (4 wire)*
ERTH 8232DX	(2) 32W 4 Pin Lamp 120V Line Voltage Dimmable with Mark X Ballast (2 wire)†
ERTH 8232DX-7	(2) 32W 4 Pin Lamp 277V Line Voltage Dimmable Ballast (2 wire)†

ERTH 8142E	(1) 42W 4 Pin Lamp 120/277V H.P.F. Electronic Ballast
ERTH 8142D	(1) 42W 4 Pin Lamp 120/277V 0-10V Dimmable Ballast (4 wire)*
ERTH 8142DX	(1) 42W 4 Pin Lamp 120V Line Voltage Dimmable with Mark X Ballast (2 wire)†
ERTH 8142DX-7	(1) 42W 4 Pin Lamp 277V Line Voltage Dimmable Ballast (2 wire)†

ERTH 8242E	(2) 42W 4 Pin Lamp 120/277V H.P.F. Electronic Ballast
ERTH 8242D	(2) 42W 4 Pin Lamp 120/277V 0-10V Dimmable Ballast (4 wire)*
ERTH 8242DX	(2) 42W 4 Pin Lamp 120V Line Voltage Dimmable with Mark X Ballast (2 wire)†
ERTH 8242DX-7	(2) 42W 4 Pin Lamp 277V Line Voltage Dimmable Ballast (2 wire)†

EL 827C
 Suspended Glass Trim
 with Clear Reflector
 O.D.: 9"



EL 843B
EL 843W
 Baffle Trim with
 Regressed Lens
 O.D.: 9"



EL 831B
EL 831W
 Reflector
 with Baffle
 O.D.: 9"



EL 882G
EL 882C
 Clear and Gold
 Reflector with
 Regressed Lens
 O.D.: 9"



EL 841G
EL 841C
EL 841F
 Reflector Trim
 O.D.: 9"



EL 889C
EL 889G
 Reflector with
 Cross Blades
 O.D.: 9"



8" Energy Efficient Architectural CFL Wall Wash Retrofit

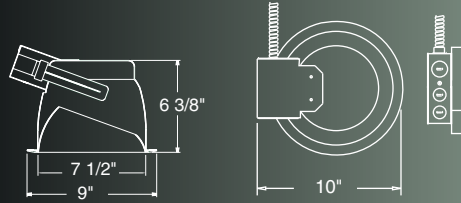

Height: 6 3/8"
 Ceiling Opening: 7 3/4" to 8 1/2"
 Trim O.D. : 9"

- Compact fluorescent wall wash retrofit kit for (2) 13-42W lamps with thermally protected electronic ballast.
- Junction box with 1/2" and 3/4" pryouts, listed for 8 #12 90°C conductors.
- Emergency battery back-up ballast (optional)
- U.L. listed for damp location.

ERT 800E (2) 13W 4 Pin Lamp 120/277V H.P.F. Electronic Ballast
 ERT 800D (2) 13W 4 Pin Lamp 120/277V 0-10V Dimmable Ballast (4 wire)*

ERT 850E (2) 18W 4 Pin Lamp 120/277V H.P.F. Electronic Ballast
 ERT 850D (2) 18W 4 Pin Lamp 120/277V 0-10V Dimmable Ballast (4 wire)*
 ERT 850DX (2) 18W 4 Pin Lamp 120V Line Voltage Dimmable with Mark X Ballast (2 wire)†
 ERT 850DX-7 (2) 18W 4 Pin Lamp 277V Line Voltage Dimmable Ballast (2 wire)†

ERT 875E (2) 26W 4 Pin Lamp 120/277V H.P.F. Electronic Ballast
 ERT 875D (2) 26W 4 Pin Lamp 120/277V 0-10V Dimmable Ballast (4 wire)*
 ERT 875DX (2) 26W 4 Pin Lamp 120V Line Voltage Dimmable with Mark X Ballast (2 wire)†
 ERT 875DX-7 (2) 26W 4 Pin Lamp 277V Line Voltage Dimmable Ballast (2 wire)†

ERT 880E (2) 32W 4 Pin Lamp 120/277V H.P.F. Electronic Ballast

ERT 885E (2) 42W 4 Pin Lamp 120/277V H.P.F. Electronic Ballast

EL 921B
 EL 921W
 Wall Wash
 Reflector Trim
 O.D.: 9"



EL 921G
 Wall Wash
 Reflector Trim
 O.D.: 9"



EL 921C
 Wall Wash
 Reflector Trim
 O.D.: 9"



347V electronic ballast available upon request
 D = Advance Mark VII dimming ballast or similar
 DX = Advance Mark X dimming ballast or similar
 Other dimming ballast (Lutron) are available upon request at extra charge

8" Energy Efficient Architectural Vertical CFL Retrofit



Height: 10 1/4"
 Ceiling Opening: 7 3/4" TO 8 1/2"
 Trim O.D. : 9"

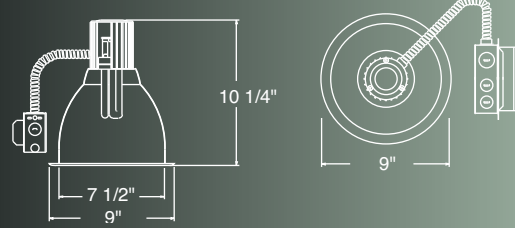

- Compact fluorescent fixtures designed for one 13W to 42W compact fluorescent lamp.
- Trim support adjusts 3/4" to accommodate different ceiling thickness.
- U.L. damp location & feed through listed.
- Thermally protected "Class P", HPF electronic ballast (universal coltage).
- Emergency battery back-up ballast (optional)

ERTV 8113E	(1) 13W 4 Pin Lamp 120/277V Electronic Ballast
ERTV 8118E	(1) 18W 4 Pin Lamp 120/277V Electronic Ballast
ERTV 8118D	(1) 18W 4 Pin Lamp 120/277V 0-10V Electronic Dimmable Ballast (4 wire)*
ERTV 8118DX	(1) 18W 4 Pin Lamp 120V Line Voltage Electronic Dimmable Ballast (2 wire)†
ERTV 8118DX-7	(1) 18W 4 Pin Lamp 277V Line Voltage Electronic Dimmable Ballast (2 wire)†
ERTV 8126E	(1) 26W 4 Pin Lamp 120/277V H.P.F Electronic Ballast
ERTV 8126D	(1) 26W 4 Pin Lamp 120/277V 0-10V Electronic Dimmable Ballast (4 wire)*
ERTV 8126DX	(1) 26W 4 Pin Lamp 120V Line Voltage Electronic Dimmable Ballast (2 wire)†
ERTV 8126DX-7	(1) 26W 4 Pin Lamp 277V Line Voltage Electronic Dimmable Ballast (2 wire)†
ERTV 8132E	(1) 32W 4 Pin Lamp 120/277V H.P.F Electronic Ballast
ERTV 8132D	(1) 32W 4 Pin Lamp 120/277V 0-10V Electronic Dimmable Ballast (4 wire)*
ERTV 8132DX	(1) 32W 4 Pin Lamp 120V Line Voltage Electronic Dimmable Ballast (2 wire)†
ERTV 8132DX-7	(1) 32W 4 Pin Lamp 277V Line Voltage Electronic Dimmable Ballast (2 wire)†
ERTV 8142E	(1) 42W 4 Pin Lamp 120/277V H.P.F Electronic Ballast
ERTV 8142D	(1) 42W 4 Pin Lamp 120/277V 0-10V Electronic Dimmable Ballast (4 wire)*
ERTV 8142DX	(1) 42W 4 Pin Lamp 120V Line Voltage Electronic Dimmable Ballast (2 wire)†
ERTV 8142DX-7	(1) 42W 4 Pin Lamp 277V Line Voltage Electronic Dimmable Ballast (2 wire)†

EL 816C
 EL 816F
 EL 816G
 Suspended Glass Trim
 Lamp: (1) 42W PL Max
 O.D.: 9"



EL 833B
 EL 833w
 Reflector with Baffle
 Lamp: (1) 42W PL Max
 O.D.: 9"



EL 828C
 EL 828G
 Suspended Glass Trim
 Lamp: (1) 42W PL Max
 O.D.: 9"



EL 852B
 EL 852W
 Reflector with Baffle
 and Regressed Lens
 Lamp: (1) 42W PL Max
 O.D.: 9"



EL 832G
 EL 832C
 Reflector with Regressed
 Lens
 Lamp: (1) 42W PL Max
 O.D.: 9"



347V electronic ballast available upon request
 * Advance Mark VII dimming ballast or similar
 † Advance Mark X dimming ballast or similar
 Other dimming ballast (Lutron are available upon request at extra charge

7" Energy Efficient Achitectural Horizontal CFL Retrofit

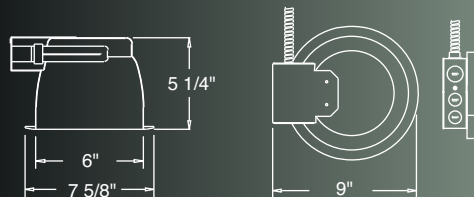

Height: 5 1/4"
 Ceiling Opening: 6 1/8" to 7 1/2"
 Trim O.D. : 7 5/8"

- Compact fluorescent retrofit kit for two horizontally mounted lamps.
- Trim support adjusts 3/4" to accomodate different ceiling thickness.
- 5 1/4" height allows use in 2 x 6 construction
- U.L. damp location & feed through listed.
- Emergency battery back-up ballast (optional)
- Single two lamp, HPF Class P. 120-277V ballast on electric units.
- Two single lamp potted, class P ballasts on units with magnetic ballasts (may be wired for independent switching).

NEW! EARTH 7213E	(2)13W 4 Pin Lamp 120/277V H.P.F. Electronic Ballast
ERTH 7213D	(2)13W 4 Pin Lamp 120/277V 0-10V Dimmable Ballast (4 wire)*
ERTH 7118E	(1)18W 4 Pin Lamp 120/277V H.P.F. Electronic Ballast
ERTH 7118D	(1)18W 4 Pin Lamp 120/277V 0-10V Dimmable Ballast (4 wire)*
ERTH 7118DX	(1)18W 4 Pin Lamp 120V Line Voltage Dimmable Ballast (2 wire)†
ERTH 7118DX-7	(1)18W 4 Pin Lamp 277V Line Voltage Dimmable Ballast (2 wire)†
ERTH 7218E	(2)18W 4 Pin Lamp 120/277V H.P.F. Electronic Ballast
ERTH 7218D	(2)18W 4 Pin Lamp 120/277V 0-10V Dimmable Ballast (4 wire)*
ERTH 7218DX	(2)18W 4 Pin Lamp 120V Line Voltage Dimmable Ballast (2 wire)†
ERTH 7218DX-7	(2)18W 4 Pin Lamp 277V Line Voltage Dimmable Ballast (2 wire)†

EL 721C
 EL 721G
 EL 721F
 Clear Reflector Trim
 O.D.: 7 1/2"



EL 745W
 EL 745B
 Wall Wash Trim
 O.D.: 7 5/8"



EL 730B
 EL 730W
 Reflector with
 Baffle Trim
 O.D.: 7 5/8"



EL 762G
 EL 762B
 EL 762C
 EL 762W
 Reflector with
 Regressed
 Prismatic Lens
 O.D.: 7 5/8"



EL 742W
 EL 742B
 Reflector with Baffle
 and Regressed Lens
 O.D.: 7 5/8"



EL 777C
 Chrome Reflector
 with Cross Blades
 O.D.: 7 5/8"



7" Energy Efficient Achitectural Horizontal CFL Retrofit

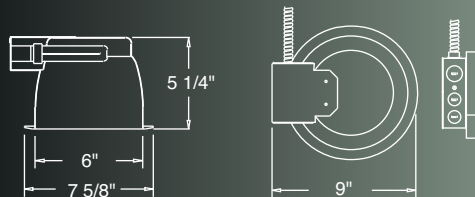

Height: 5 1/4"
 Ceiling Opening: 6 1/8" to 7 1/2"
 Trim O.D. : 7 5/8"

- High brightness downlights for use with 26W, 32W and 42W lamps.
- One ballast operates two 26W or single 32/42W lamp, electronic ballasts 120V/277V.
- Trim supports adjusts 3/4" to accomodate different ceiling thickness. Trim can be installed without tools.
- 5 1/4" height allows for use in 2 x 6 construction.
- U.L. damp location and feed through listed.
- Emergency battery back-up ballast (optional)

NEW! EARTH 7126E	(1) 26W 4 Pin Lamp 120/277V H.P.F. Electronic Ballast
ERTH 7126D	(1) 26W 4 Pin Lamp 120/277V 0-10V Dimmable Ballast (4 wire)*
ERTH 7126DX	(1) 26W 4 Pin Lamp 120V Line Voltage Dimmable Ballast (2 wire)†
ERTH 7126DX-7	(1) 26W 4 Pin Lamp 277V Line Voltage Dimmable Ballast (2 wire)†

NEW! EARTH 7226E	(2) 26W 4 Pin Lamp 120/277V H.P.F. Electronic Ballast
ERTH 7226D	(2) 26W 4 Pin Lamp 120/277V 0-10V Dimmable Ballast (4 wire)*
ERTH 7226DX	(1) 26W 4 Pin Lamp 120V Line Voltage Dimmable Ballast (2 wire)†
ERTH 7226DX-7	(1) 26W 4 Pin Lamp 277V Line Voltage Dimmable Ballast (2 wire)†

ERTH 7132E	(1) 32W 4 Pin Lamp 120/277V H.P.F. Electronic Ballast
ERTH 7132D	(1) 32W 4 Pin Lamp 120/277V 0-10V Dimmable Ballast (4 wire)*
ERTH 7132DX	(1) 32W 4 Pin Lamp 120V Line Voltage Dimmable Ballast (2 wire)†
ERTH 7132DX-7	(1) 32W 4 Pin Lamp 277V Line Voltage Dimmable Ballast (2 wire)†

ERTH 7142E	(1) 42W 4 Pin Lamp 120/277V H.P.F. Electronic Ballast
ERTH 7142D	(1) 42W 4 Pin Lamp 120/277V 0-10V Dimmable Ballast (4 wire)*
ERTH 7142DX	(1) 42W 4 Pin Lamp 120V Line Voltage Dimmable Ballast (2 wire)†
ERTH 7142DX-7	(1) 42W 4 Pin Lamp 277V Line Voltage Dimmable Ballast (2 wire)†

EL 731B
 EL 731W
 Reflector
 with Baffle Trim
 O.D.: 7 5/8"



EL 778C
 Chrome Reflector
 with Cross Blades
 O.D.: 7 5/8"



EL 741G
 EL 741C
 Reflector Trim
 O.D.: 7 5/8"



EL 782C
 EL 782G
 EL 782W
 Reflector
 with Regressed
 Prismatic Lens
 O.D.: 7 5/8"



EL 743W
 EL 743B
 Reflector with Baffle
 and Regressed Lens
 O.D.: 7 5/8"



347V electronic ballast available upon request
 * Advance Mark VII dimming ballast or similar
 † Advance Mark X dimming ballast or similar

Other dimming ballast (Lutron are available upon request at extra charge

7" Energy Efficient Architectural CFL Wall Wash Retrofit with Spread Lens

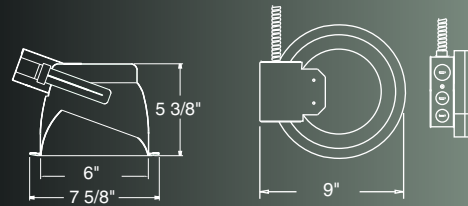

Height: 5 3/8"
 Ceiling Opening: 6 1/8" to 7 1/2"
 Trim O.D. : 7 5/8"

- Compact fluorescent housing for two horizontally mounted lamps.
- Thermally protected magnetic fixtures are supplied with two single-lamp potted ballasts and may be wired for independent switching
- Electronic units are supplied with one two-lamp ballast for 4 pin lamps (universal voltage)
- Junction box with 1/2" and 3/4" pryouts, listed for 8 #12 90°C conductors.
- Fits in 2 x 6 ceiling construction (5 3/8" deep).
- Emergency battery back-up ballast (optional)
- U.L. damp location

ERT 700E (2) 13W 4 Pin Lamp 120/277V H.P.F. Electronic Ballast
 ERT 700D (2) 13W 4 Pin Lamp 120/277V 0-10V Dimmable Ballast (4 wire)*

ERT 750E (2) 18W 4 Pin Lamp 120/277V H.P.F. Electronic Ballast
 ERT 750D (2) 18W 4 Pin Lamp 120/277V 0-10V Dimmable Ballast (4 wire)*
 ERT 750DX (2) 18W 4 Pin Lamp 120V Line Voltage Dimmable Ballast (2 wire)†
 ERT 750DX-7 (2) 18W 4 Pin Lamp 277V Line Voltage Dimmable Ballast (2 wire)†

ERT 775E (2) 26W 4 Pin Lamp 120/277V H.P.F. Electronic Ballast
 ERT 775D (2) 26W 4 Pin Lamp 120/277V 0-10V Dimmable Ballast (4 wire)*
 ERT 775DX (2) 26W 4 Pin Lamp 120V Line Voltage Dimmable Ballast (2 wire)†
 ERT 775DX-7 (2) 26W 4 Pin Lamp 277V Line Voltage Dimmable Ballast (2 wire)†

EL 621B
 Wall Wash
 Reflector Trim
 O.D.: 7 5/8"



EL 621G
 Wall Wash
 Reflector Trim
 O.D.: 7 5/8"



EL 621C
 Wall Wash
 Reflector Trim
 O.D.: 7 5/8"



347V electronic ballast available upon request
 * Advance Mark VII dimming ballast or similar
 † Advance Mark X dimming ballast or similar

Other dimming ballast (Lutron are available upon request at extra charge

7" Energy Efficient Architectural Vertical CFL Retrofit



Height: 8 3/4"
 Ceiling Opening: 6 1/8" TO 7 1/2"
 Trim O.D. : 7 5/8"

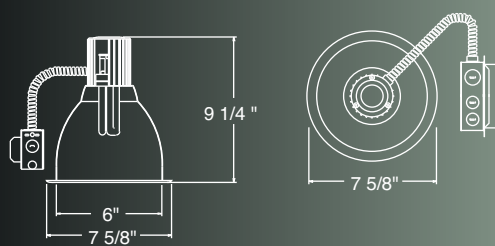

- Compact fluorescent retrofit kit designed for one vertical compact fluorescent lamp.
- Trim support adjusts 3/4" to accommodate different ceiling thickness.
- U.L. damp location listed
- U.L. feed through listed.
- Electronic units include Thermally protected "Class P", HPF electronic ballast (universal voltage)
- Emergency battery back-up ballast (optional)

ERTV 7113E (1) 13W 4 Pin Lamp 120/277V H.P.F. Electronic Ballast

ERTV 7118E (1) 18W 4 Pin Lamp 120/277V H.P.F. Electronic Ballast

ERTV 7118D (1) 18W 4 Pin Lamp 120/277V 0-10V Dimmable Ballast (4 wire)*

ERTV 7118DX (1) 18W 4 Pin Lamp 120V Line Voltage Dimmable Ballast (2 wire)†

ERTV 7118DX-7 (1) 18W 4 Pin Lamp 277V Line Voltage Dimmable Ballast (2 wire)†

NEW! ERTV 7126E (1) 26W 4 Pin Lamp 120/277V H.P.F. Electronic Ballast

ERTV 7126D (1) 26W 4 Pin Lamp 120/277V 0-10V Dimmable Ballast (4 wire)*

ERTV 7126DX (1) 26W 4 Pin Lamp 120V Line Voltage Dimmable Ballast (2 wire)†

ERTV 7126DX-7 (1) 26W 4 Pin Lamp 277V Line Voltage Dimmable Ballast (2 wire)†

ERTV 7132E (1) 32W 4 Pin Lamp 120V H.P.F. Electronic Ballast

ERTV 7132D (1) 32W 4 Pin Lamp 120/277V 0-10V Dimmable Ballast (4 wire)*

ERTV 7132DX (1) 32W 4 Pin Lamp 120V Line Voltage Dimmable Ballast (2 wire)†

ERTV 7132DX-7 (1) 32W 4 Pin Lamp 277V Line Voltage Dimmable Ballast (2 wire)†

ERTV 7142E (1) 42W 4 Pin Lamp 120V H.P.F. Electronic Ballast

ERTV 7142D (1) 42W 4 Pin Lamp 120/277V 0-10V Electronic Dimmable Ballast (4 wire)*

ERTV 7142DX (1) 42W 4 Pin Lamp 120V Line Voltage Electronic Dimmable Ballast (2 wire)†

ERTV 7142DX-7 (1) 42W 4 Pin Lamp 277V Line Voltage Electronic Dimmable Ballast (2 wire)†

EL 716C

EL 716G

EL 716F

Reflector Trim

Lamp: (1) 42W PL Max

O.D.: 7 5/8"



EL 752W

EL 752B

Reflector with Baffle and Regressed Lens

Lamp: (1) 42W PL Max

O.D.: 7 5/8"



EL 732C

EL 732G

Reflector with

Regressed Lens

Lamp: (1) 42W PL Max

O.D.: 7 5/8"



EL 755W

EL 755B

Wall Wash with Baffle

Lamp: (1) 42W PL Max

O.D.: 7 5/8"



EL 733B

EL 733W

Reflector with Baffle Trim

Lamp: (1) 42W PL Max

O.D.: 7 5/8"



347V electronic ballast available upon request

* Advance Mark VII dimming ballast or similar

† Advance Mark X dimming ballast or similar

Other dimming ballast (Lutron are available upon request at extra charge



6" Energy Efficient Compact Fluorescent Retrofit Kits

- ELCO retrofit compact fluorescent units operate efficiently and economically; They are especially well suited for installations that require continuous lighting, These units with long life compact fluorescent lamps provide good color rendition and lumen maintenance and generate less heat.
- This Retrofit kit is used for converting existing 6" type IC or Non IC housing to energy efficient compact fluorescent fixture.
- Thermally protected (class P) Ballast.
- Retrofit Kit with high reflectance Reflector, wall wash or with Baffle Reflector for different applications.

- A** 6" Universal Housing
- B** Screw Base Adapter attaches to housing socket.
- C** ELCO's retrofit kit includes the reflector. The compact fluorescent lamp can be changed in the ceiling.
- D** Reflector; Prismatic Lens
- E** 13W Quad lamp, not included.

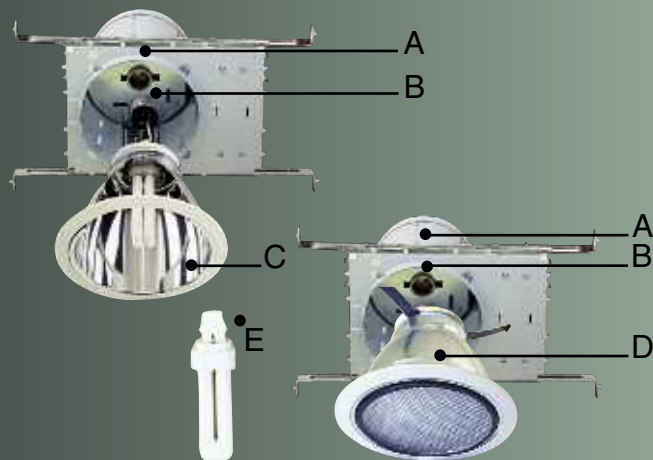

6" Compact Fluorescent Retrofit Kits

KPL-201B

Reflector with Baffle,
120V N.P.F Ballast
Lamp: 13W Twin/Quad 2 Pin
O.D.: 7 1/4"



KPL-66C, 120V, N.P.F. Ballast

KPL-66C-HP, 120V, H.P.F. Ballast
Clear Reflector
Lamp: 13W Quad 2 Pin
O.D.: 7 1/4"



KPL-201W, 120V, N.P.F. Ballast

KPL-201W-HP, 120V, H.P.F. Ballast
Reflector with Baffle,
Lamp: 13W Twin/Quad 2 Pin
O.D.: 7 1/4"



KPL-66G

Gold Reflector 120V
N.P.F. Ballast
Lamp: 13W Quad 2 Pin
O.D.: 7 1/4"



KPL-201EW, for 13W 4 Pin Quad

KPL-202EW, for 18W 4 Pin Quad/Triple

KPL-203E B/W, for 26W 4 Pin Quad

KPL-204E B/W, for 32W 4 Pin Triple

Reflector with Baffle
Lamp: 13-32W Quad/Triple 4 Pin
O.D.: 7 1/4"



KPL-66W

KPL-66B
Retrofit with Reflector
Lamp: 13W Quad 2 Pin
O.D.: 7 1/4"



KPL-62C

Clear Reflector with Albalite
120V N.P.F. Ballast
Lamp: 13W Quad, 2 Pin
O.D.: 7 1/4"



KPW-201W

KPW-201B
Wall Wash
Baffle Reflector
Lamp: 13W Quad 2 Pin
O.D.: 7 1/4"



Note: 26W and 32W Kits are not for use in IC Housings

U.S. Patent 5,440,471

6" Compact Fluorescent Retrofit Kits (Cont.)

KPW-62C
Wall Wash Reflector
Lamp: 13W Quad
O.D.: 7 1/4"



KPW-66W
KPW-66B
KPW-66C
KPW-66G
Wall Wash
Lamp: 13W Quad
O.D.: 7 1/4"



6" Electronic Compact Fluorescent Retrofit Kits 13W, 18W, 26W, and 32W

A 6" Universal Housing

B Screw Base Adapter attaches to housing socket.

C ELCO's retrofit kit includes the reflector. The compact fluorescent lamp can be changed in the ceiling.

D Reflector; Prismatic Lens

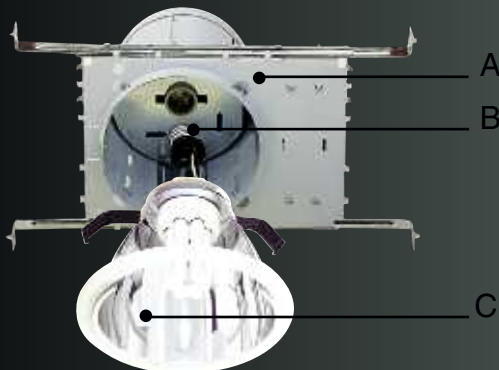

6" Retrofit Electronic Compact Fluorescent Trims

KPL-62E (1)13W
KPL-63E (1)18W
KPL-64E (1)26W
KPL-65E (1)32W

Reflector with Lens
120V
O.D.: 7 1/4"



KPL-66E B/C/G/W (1)13W
KPL-67E B/C/G/W (1)18W
KPL-68E B/C/G/W (1)26W
KPL-69E B/C/G/W (1)32W

Reflector with White Finish
120V
O.D.: 7 1/4"



KPL-66E B/C/G/W (1)13W
KPL-67E B/C/G/W (1)18W
KPL-68E B/C/G/W (1)26W
KPL-69E B/C/G/W (1)32W

Reflector with Clear Finish
120V
O.D.: 7 1/4"



NEW! KPL-66E B/C/G/W (1)13W
KPL-67E B/C/G/W (1)18W
KPL-68E B/C/G/W (1)26W
KPL-69E B/C/G/W (1)32W

Reflector with Gold Finish
120V
O.D.: 7 1/4"



Note: 26W and 32W Kits are not for use in IC Housings
U.S. Patent 5,440,471

6" Retrofit Electronic Compact Fluorescent Retrofit Kits(Cont.)

KPW-66E	B/C/G/W	(1)13W
KPW-67E	B/C/G/W	(1)18W
KPW-68E	B/C/G/W	(1)26W
KPW-69E	B/C/G/W	(1)32W

Wall Wash
with Reflector
120V
O.D.: 7 1/4"



KPW-201E	B/W	(1)13W
KPW-202E	B/W	(1)18W
KPW-203E	B/W	(1)26W
KPW-204E	B/W	(1)32W

Retrofit available
with a White or
Black Baffle
120V
O.D.: 7 1/4"



NOTE: 347V Available consult factory

Compact Fluorescent Lamp Data							Fluorescent		Incandescent
Catalog#	Wattage (W)	Type Lamp	Chrome	Gold	White	Black	Life(Hrs)	Lumens	Wattage
KPL 66E	13	Quad	•	•	•	•	10,000	870	60W
KPL 67E	18	Quad	•	•	•	•	10,000	1,200	75W
KPL 68E	26	PL-T26	•	•	•	•	10,000	1,800	100W
KPL 69E	32	PL-T32	•	•	•	•	10,000	2,400	120W
KPL 201E	13	Quad			•	•	10,000	870	60W
KPL 202E	18	Quad			•	•	10,000	1,200	75W
KPL 203E	26	PL-T26			•	•	10,000	1,800	100W
KPL 204E	32	PL-T32	•	•	•	•	10,000	2,400	120W
KPL 62E	13	Quad	•	•	•	•	10,000	870	60W
KPL 63E	18	Quad	•	•	•	•	10,000	1,200	75W
KPL 64E	26	PL-T26	•	•	•	•	10,000	1,800	100W
KPL 65E	32	PL-T32			•	•	10,000	2,400	120W
KPL 201E	13	Quad			•	•	10,000	870	60W
KPL 202E	18	Quad			•	•	10,000	1,200	75W
KPL 203E	26	PL-T26			•	•	10,000	1,800	100W
KPL 204E	32	PL-T32			•	•	10,000	2,400	120W

U.S. Patent 5,440,471

6" Electronic Compact Fluorescent Retrofit Kits 13W, 18W, 26W, and 32W

- Converts most 6" recessed housing to Energy Efficient Compact Fluorescent Housings.
- Compatible with variety of trims (existing trims)
- Available in hard wire or Edison screw base.
- Power factor greater than .97% H.P.F. Electronic Ballast
- Thermally Protected (class P) Ballast.
- Includes (1) PL Lamp.
- Listed for damp locations.



A 6" Universal Housing

B Screw Base Adapter attaches to housing socket.

KPL-13E

Lamp: (1) 13W 4 Pin PL-T/13
(Triple) 120V



KPL-18E

Lamp: (1) 18W 4 Pin PL-T/13
(Triple) 120V



KPL-26E

Lamp: (1) 26W 4 Pin PL-T/13
(Triple) 120V



KPL-32E

Lamp: (1) 32W 4 Pin PL-T/32
(Triple) 120V



Note: 26W and 32W Kits are not for use in IC Housings

Magnetic Compact Fluorescent Retrofit

(1) 13W and (2) 13W

Compact Fluorescent Retrofit Kit, H.P.F., N.P.F.

- 13W Class P thermally protected ballast.
- Fits most 6" recessed housings.
- Available in hard wire or Edison medium screw base.
- For (1) 13W or (2) 13W Quad "PL". (2 Pin)
- Height: 3 1/4" Dia: 5 1/2".
- Lamp not included.

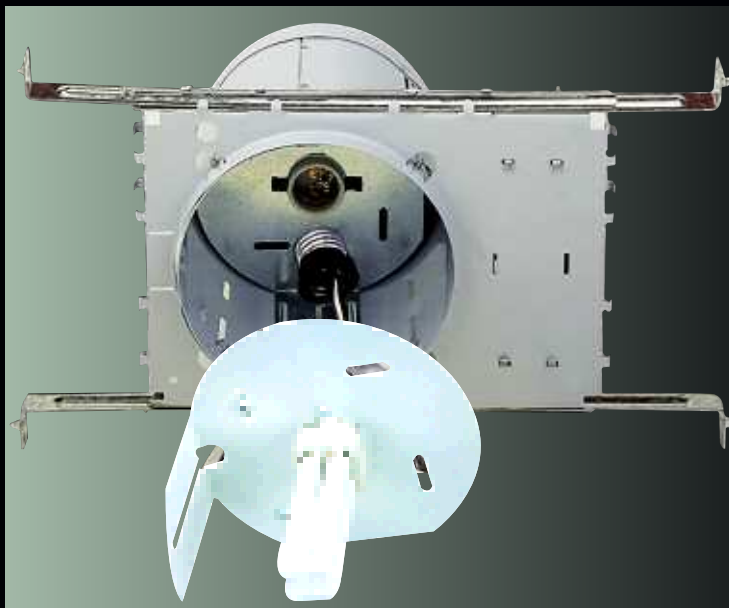

A 6" Universal Housing

B Screw Base Adapter attaches to housing socket.

KPL-213

N.P.F. Ballast

Compact Fluorescent Kit.
Fits most 6" Universal Housings.
Lamp: 2-13W-Quad 2 Pin



KPL-113

N.P.F. Ballast

Compact Fluorescent Kit.
Fits most 6" Universal Housings.
Lamp: 1-13W-Quad 2 Pin



6" Energy Efficient Low Voltage Retrofit for Lightolier®

NEW!



A Existing Lightolier®
1102 Frame (TYP)

B ELOLK75 Retrofit Kit with
Electronic Transformer, for
Lightolier 1102 Frame Kit to
L.V. Trim

C EL2597W Low Voltage
Adjustable Trim

6" Energy Efficient Low Voltage Retrofit for Lightolier® (Cont.)

EL 2511C
EL 2511G
EL 2511W
EL 2511B
Adjustable Spot Trim
Lamp: MR16-75W
O.D.: 7 1/4"



EL 2597B
EL 2597W
EL 2597N
Adjustable Pull Down
Lamp: MR16-75W
O.D.: 7 1/4"



EL 2529W
EL 2529B
Pinhole Trim with Baffle
Lamp: MR16-75W
Hole: 2" I.D.
O.D.: 8"



EL 2597BZ
Adjustable Pull Down
Lamp: MR16-75W
O.D.: 7 1/4"

NEW!



EL 2516C
EL 2516G
EL 2516W
EL 2516B
Adjustable
Reflector Trim
Lamp: MR16-75W
O.D.: 7 1/4"



EL 2597CP
Adjustable Pull Down
Lamp: MR16-75W
O.D.: 7 1/4"

NEW!



EL 2550W
EL 2550B
Adjustable
Slot Aperture
Lamp: MR16-75W
Slot: 1 3/8 x 2 1/4"
O.D.: 7 1/4"



EL 2568W
Adjustable Spot Trim
Lamp: MR16-75W
O.D.: 7 1/4"



EL 2576C
EL 2576G
EL 2576B
EL 2576W
Reflector with Adjustable
Gimbal Ring
Lamp: PAR36/AR111 50-75W
O.D.: 7 1/4"



EL 2530W
EL 2530B
Adjustable Baffle Trim
Lamp: MR16-75W
O.D.: 7 1/2"



EL 2517W
Eyeball Trim
Lamp: MR16-75W
O.D.: 7 1/4"



EL 2521B
EL 2521C
EL 2521G
EL 2521W
Reflector Cone Trim
Lamp: MR16-75W
I.D.: 3 1/4"
O.D.: 7 1/4"



5" Energy Efficient Magnetic Compact Fluorescent Retrofit Kits

ELCO retrofit compact fluorescent units operate efficiently and economically; They are especially well suited for installations that require continuous lighting. These units with long life compact fluorescent lamps provide good color rendition and generate less heat.

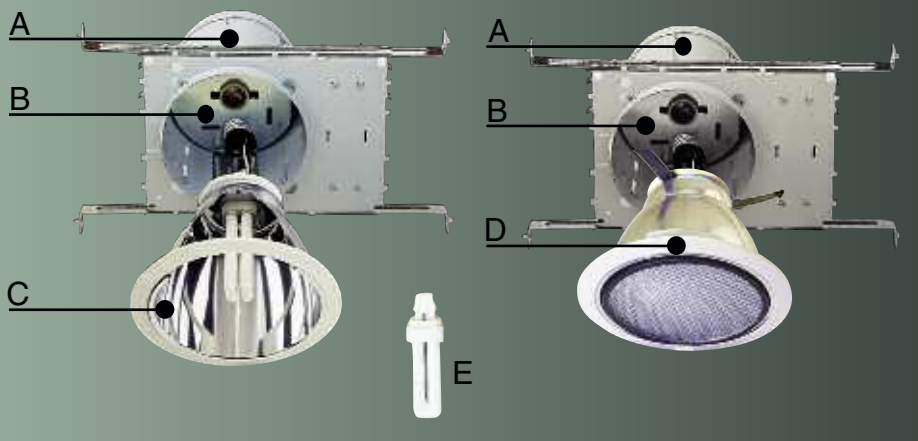

- A 5" Universal Housing. (Not included)
- B Screw base adapter attaches to the housing socket.
- C ELCO's retrofit kit includes reflector, ballast and socket adapter.
- D Reflector; Prismatic Lens.
- E 13W 2 Pin GX23-2 lamp. (Not included)

- Reflectorized 13W retrofit kit for 5" recessed downlight
- Thermally protected "Class P" 120V magnetic N.P.F. ballast
- Easy installation

5" Retrofit Magnetic Compact Fluorescent Kits

INCLUDES TRIM, BALLAST AND SCREW-IN ADAPTER

KPL-56W

KPL-56B

Retrofit with Reflector
Lamp: 13W 2 Pin Quad
O.D.: 7 1/4"



KPL-501B

Retrofit with Baffle
Lamp: 13W 2 Pin Quad
O.D.: 7 1/4"



KPL-56C

Retrofit with Reflector
Lamp: 13W 2 Pin Quad
O.D.: 7 1/4"



KPL-501W

Retrofit with Baffle
Lamp: 13W 2 Pin Quad
O.D.: 7 1/4"



KPL-56G

Retrofit with Reflector
Lamp: 13W 2 Pin Quad
O.D.: 7 1/4"



U.S. Patent 5,440,471

5" Energy Efficient Electronic Compact Fluorescent Retrofit Kits 13W, 18W, 26W and 32W

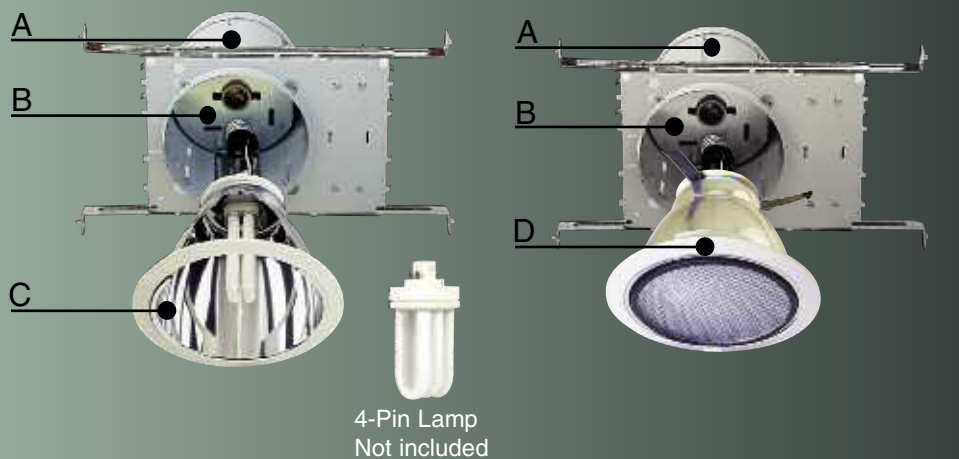

- A 5" Universal housing. (Not included)
- B Screw base adapter attaches to the housing socket.
- C Elco retrofit kit includes reflector, electronic ballast and socket adapter.
- D Reflector: Prismatic lens.

- Reflectorized 13W - 32W retrofit kit for 5" recessed downlight for better efficiency.
- Thermally protected "Class P" 120V H.P.F. electronic ballast.
- Easy installation.

5" Retrofit Electronic Compact Fluorescent Kits Includes Trim, Ballast and Screw-In Adapter

KPL-56E (1) 13W 4 Pin
 KPL-57E (1) 18W 4 Pin
 KPL-58E (1) 26W 4 Pin
 KPL-59E (1) 32W 4 Pin
 Reflector with Clear finish, 120V
 O.D.: 7 1/4"



KPL-56EG (1) 13W 4 Pin
 KPL-57EG (1) 18W 4 Pin
 KPL-58EG (1) 26W 4 Pin
 KPL-59EG (1) 32W 4 Pin
 Reflector with Gold finish, 120V
 O.D.: 7 1/4"



KPL-56EW (1) 13W 4 Pin
 KPL-57EW (1) 18W 4 Pin
 KPL-58EW (1) 26W 4 Pin
 KPL-59EW (1) 32W 4 Pin
 Reflector with White finish, 120V
 O.D.: 7 1/4"



KPL-501E (1) 13W 4 Pin
 KPL-502E (1) 18W 4 Pin
 KPL-503E (1) 26W 4 Pin
 KPL-504E (1) 32W 4 Pin
 Reflector with White Baffle, 120V
 O.D.: 7 1/4"



Note: 26W and 32W Kits are not for use in IC Housings
 U.S. Patent 5,440,471

5" Energy Efficient Electronic Compact Fluorescent Retrofit Kits 13W, 18W, 26W and 32W

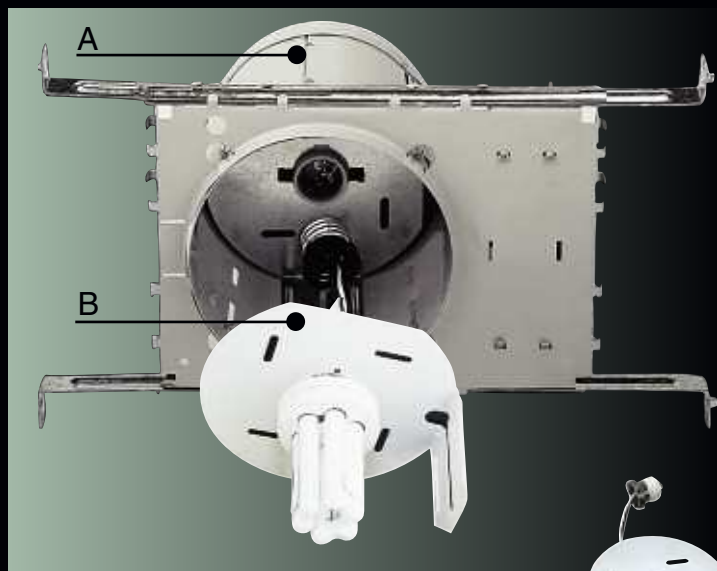

- Converts most 5" recessed housing to Energy Efficient Compact Fluorescent Housings.
 - Thermally protected "Class P" H.P.F. 120V 50/60Hz electronic ballast.
 - No interference with remote controls.
 - Available in hard wire or Edison screw base.
 - Easy installation.
 - Includes (1) PL Lamp.
- * 26W and 32W kits are not for use in IC housings.

A 5" Universal Housing. (Not included)

B Screw base adapter attaches to the housing socket.

Trim not included.



KPL-513E
Lamp: (1) 13W
4 Pin 120V



KPL-518E
Lamp: (1) 18W
4 Pin 120V



KPL-526E
Lamp: (1) 26W
4 Pin 120V



KPL-532E
Lamp: (1) 32W
4 Pin 120V

5" Energy Efficient Magnetic Compact Fluorescent Retrofit (1) 13W and (2) 13W

Compact Fluorescent Retrofit Kit

- 13W "Class P" 120V thermally protected ballast
- Fits most 5" recessed housings.
- Available in hard wire or Edison screw base.
- For (1)13W or (2)13W Quad "PL" (2 Pin).
- Easy installation.
- Lamp not included.

KPL-5113 N.P.F. Ballast
Compact Fluorescent Kit.
Fits most 5" Universal Housings.
Lamp: (1) 13W 2 Pin 120V



KPL-5213 N.P.F. Ballast
Compact Fluorescent Kit.
Fits most 5" Universal Housings.
Lamp: (2) 13W Quad 2 Pin 120V

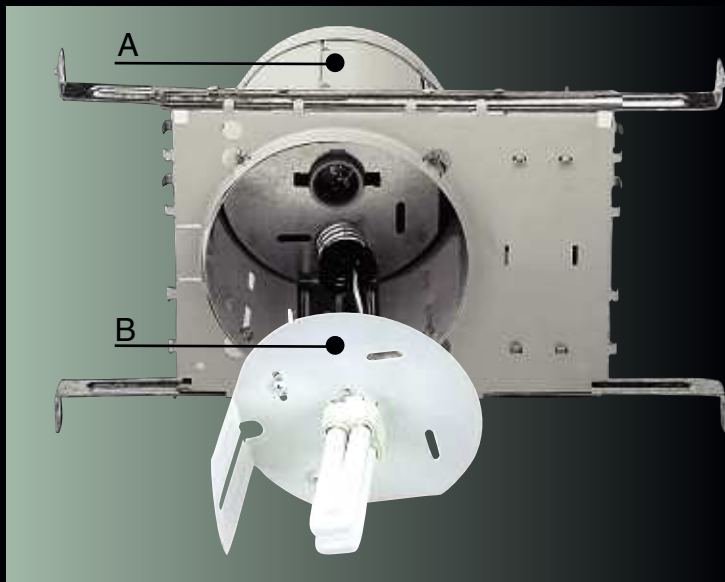

A 6" Universal Housing (Existing).

B Screw base adapter attaches to the housing socket.

Note: 26W and 32W Kits are not for use in IC Housings

Architecture H.I.D.

Elco Lighting's architectural H.I.D. downlights combine the sophisticated lamp technology of metal halide and high pressure sodium to deliver the highest quality illumination necessary for high-ceiling commercial applications such as banks, office buildings, hospitals, restaurants, shopping malls, airports, hotels and more. Aperture sizes range from 4", 6", 7", 8" and 10" and can accommodate lamps from 50W to 250W. American-made magnetic and electronic ballasts round out the package. All product specification sheets can be downloaded from our website at elcolighting.com

167-180



10" Architectural H.I.D. Metal Halide Downlights

- Recessed downlight, 10" frame for H.I.D. metal halide lamp.
- Adjustable hanger bar brackets accept 1/2" EMT, C-Channel (CH26), or Flat Bar (FB27).
- ED17/ED28 socket base metal halide lamp.
- 120/277V Magnetic or Electronic Ballast (347V Ballast available upon request)
- Lamp and hanger bars not included.
- Galvanized steel construction.
- U.L. damp location listed.
- U.L. feed through listed.
- Available with Quartz restrrike (upon request)

10" Metal Halide Housing
 Height: 13 1/2"
 Ceiling Opening: 9 1/2"
 Trim O.D.: 11 1/4"

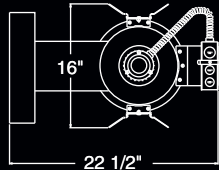
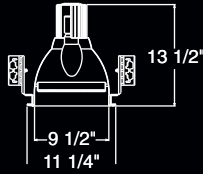

EL 1016C
 Open Reflector
 O.D.: 11 1/4"



EL 1037C
 Reflector with Lens
 O.D.: 11 1/4"



E10M70	70W, ED17 Med. Base MH Lamp, M98, M143 Magnetic Ballast
E10M70E	70W, ED17 Med. Base MH Lamp, M98, M143 Electronic Ballast
E10M100	100W ED17 Med. Base MH Lamp, M90, M140 Magnetic Ballast
E10M100E	100W ED17 Med. Base MH Lamp, M90, M140 Electronic Ballast
E10M150	150W ED17 Med. Base MH Lamp, M102, Magnetic Ballast
E10M150E	150W ED17 Med. Base MH Lamp, M102, M142 Electronic Ballast
E10M175	175W ED17 Med. Base MH Lamp, M57 Magnetic Ballast
E10M250E	250W ED28 Mogul base MH Lamp M58 Magnetic Ballast

NOTE: 175W AND 250W must be used with lensed trim.

Architectural H.I.D. High Pressure Sodium Downlights

10"

- Recessed downlight, 10" frame for H.I.D. high pressure sodium lamp.
- ED17/ED28 socket base high pressure sodium lamp.
- Lamp and hanger bars not included.
- 120/277V Magnetic Ballast included.
- Frame dimensions: 22"L x 17"W
- Galvanized steel construction.

10" High Pressure Sodium Housing
 Height: 13 1/2"
 Ceiling Opening: 9 1/2"
 Trim O.D.: 11 1/4"

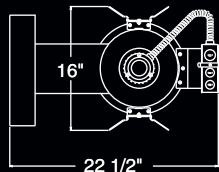
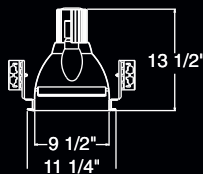

EL 1016C
 Open Reflector
 O.D.: 11 1/4"



EL 1037C
 Reflector with Lens
 O.D.: 11 1/4"



E10S70	70W S-62 High Pressure Sodium Lamp, ED17 Medium Base
E10S100	100W S-54 High Pressure Sodium Lamp, ED17 Medium Base
E10S150	150W S-55 High Pressure Sodium Lamp, ED17 Medium Base
E10S250	250W S-50 High Pressure Sodium Lamp, ED28 Medium Base

8" Architectural H.I.D. Metal Halide Downlights

39W, 50W, 70W, 100W, 150W (Magnetic Ballast)

- H.I.D. downlight designed for ED17 lamp with magnetic ballast.
- Use only "Protected" type ED17 lamp in open trims.
- Adjustable hanger bar brackets accepts 1/2" EMT, C-Channels (CH26) or flat bars (FB27).
- Trim support adjusts 3/4" to accommodate different ceiling thickness.
- 120/277V magnetic ballast included. (347V available upon request)
- U.L. damp location listed.
- U.L. feed through listed.
- Available with Quartz restrike (upon request)

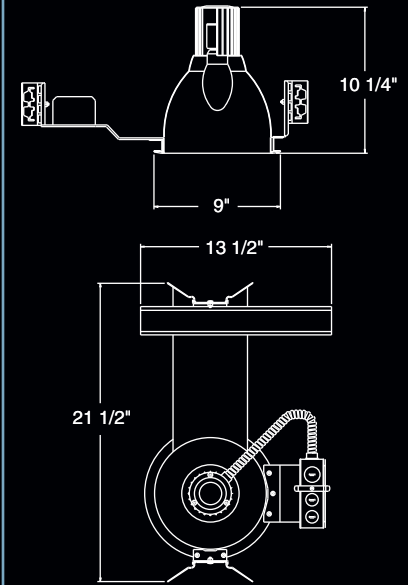

8" H.I.D. Downlight
Height: 10 1/4"
Ceiling Opening: 8"
Trim O.D.: 9"

E8M32	39W M-130, PAR Medium Base Metal Halide lamp
E8M50	50W M-110, ED17 Medium Base Metal Halide lamp
E8M70	70W M-98, M-143 PAR or ED 17 Medium Base Metal Halide lamp
E8M100	100W M-90, M-140, PAR or ED17 Medium Base Metal Halide lamp
E8M150	150W M-102, M142 ED17 Medium Base Metal Halide lamp

EL 837C
EL 837F (Self Flanged)
Clear Reflector with Fresnel Lens and Metal Ring
O.D.: 9"



EL 857W
EL 857B
Baffle with Fresnel Lens and Metal Ring
O.D.: 9"



EL 883W
White Baffle with Reflector and Metal Ring
O.D.: 9"



EL 883B
Black Baffle with Reflector and Metal Ring
O.D.: 9"



EL 899C
EL 899F (Self Flanged)
Clear Reflector Trim with Metal Ring
O.D.: 9"



8" Architectural H.I.D. Metal Halide Downlights

39W, 50W, 70W, 100W, 150W (Electronic Ballast)

- H.I.D. downlight designed for MH lamp with Electronic ballast.
- Use only "Protected" type ED17 lamp in open trims.
- Adjustable hanger bar brackets accepts 1/2" EMT, C-Channels (CH26) or flat bars (FB27).
- Trim support adjusts 3/4" to accommodate different ceiling thickness.
- 120/277V electronic ballast included.
- U.L. damp location listed.
- U.L. feed through listed.
- Available with Quartz restrike (upon request)

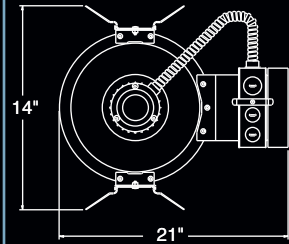
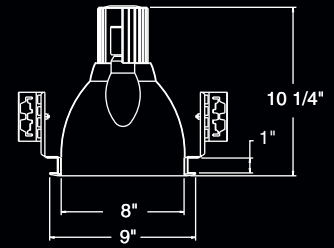

8" H.I.D. Downlight
 Height: 10 1/4"
 Ceiling Opening: 8"
 Trim O.D.: 9"

E8M32E	39W M-130, PAR Medium Base Metal Halide lamp
E8M50E	50W M-110, PAR or ED17 Medium Base Metal Halide lamp
E8M70E	70W M-143, PAR or ED 17 Medium Base Metal Halide lamp
E8M100E	100W M-90, PAR or ED17 Medium Base Metal Halide lamp
E8M150E	150W M-102, M142 ED17 Medium Base Metal Halide lamp

EL 837C
EL 837F (Self Flanged)
 Clear Reflector with Fresnel Lens and Metal Ring
 O.D.: 9"



EL 857W
EL 857B
 Baffle with Fresnel Lens and Metal Ring
 O.D.: 9"



EL 883B
 Black Baffle with Reflector and Metal Ring
 O.D.: 9"



EL 883W
 White Baffle with Reflector and Metal Ring
 O.D.: 9"



EL 899C
EL 899F (Self Flanged)
 Clear Reflector Trim with Metal Ring
 O.D.: 9"



8" Architectural H.I.D. High Pressure Sodium Downlights 50W, 70W, 100W, 150W (Magnetic Ballast)

- H.I.D. downlight designed for ED17 lamp with magnetic ballast.
- Use only "Protected" type ED17 lamp in open trims.
- Adjustable hanger bar brackets accepts 1/2" EMT, C-Channels (CH26) or flat bars (FB27).
- Trim support adjusts 3/4" to accommodate different ceiling thickness.
- 120/277V magnetic ballast included.
(347V available upon request)
- U.L. damp location listed.
- U.L. feed through listed.
- Available with Quartz restrike (upon request)

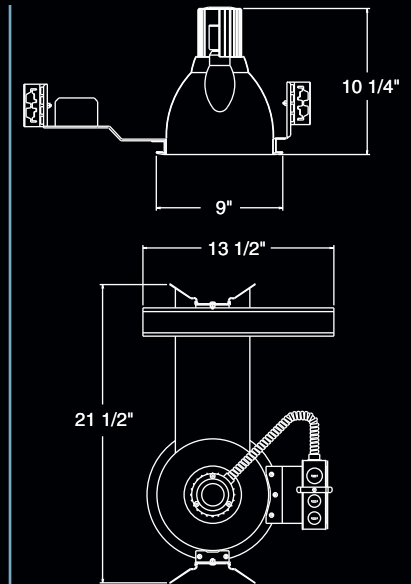

8" H.I.D. Downlight
Height: 10 1/4"
Ceiling Opening: 8"
Trim O.D.: 9"

E8S50	50W S-68 High Pressure Sodium Lamp, ED17 Medium Base
E8S70	70W S-62 High Pressure Sodium Lamp, ED17 Medium Base
E8S100	100W S-54 High Pressure Sodium Lamp, ED17 Medium Base
E8S150	150W S-55 High Pressure Sodium Lamp, ED17 Medium Base

EL 837C
EL 837F (Self Flanged)
Clear Reflector with Fresnel Lens and Metal Ring
O.D.: 9"



EL 857W
EL 857B
Baffle with Fresnel Lens and Metal Ring
O.D.: 9"



EL 883B
Black Baffle with Reflector and Metal Ring
O.D.: 9"



EL 883W
White Baffle with Reflector and Metal Ring
O.D.: 9"



EL 899C
EL 899F (Self Flanged)
Clear Reflector Trim with Metal Ring
O.D.: 9"



6" Architectural H.I.D. Metal Halide Downlights

39W, 50W, 70W, 100W (Magnetic Ballast)

- H.I.D. downlight designed for MH lamp with magnetic ballast.
- Use only "Protected" type ED17 lamp in open trims.
- Adjustable hanger bar brackets accepts 1/2" EMT, C-Channels (CH26) or flat bars (FB27).
- Trim support adjusts 3/4" to accommodate different ceiling thickness.
- 120/277V magnetic ballast included. (347V available upon request)
- U.L. damp location listed.
- U.L. feed through listed.
- Available with Quartz restrike be (upon request)

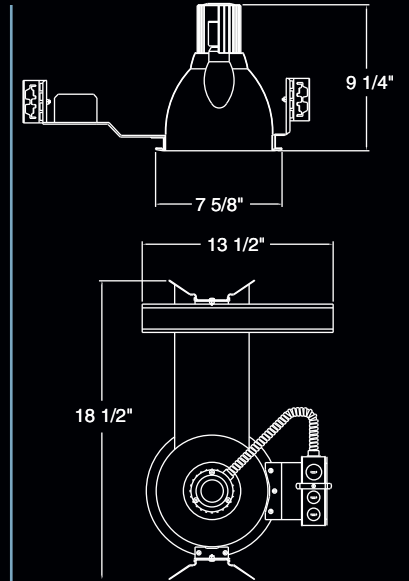

6" H.I.D. Downlight
Height: 9 1/4"
Ceiling Opening: 6"
Trim O.D.: 7 5/8"

E6M32	39W M-130, PAR Medium Base Metal Halide lamp
E6M50	50W M-110, ED17 Medium Base Metal Halide lamp
E6M70	70W M-98, M-143, M101, PAR or ED17 Medium Base Metal Halide lamp
E6M100	100W M-90, M-140, PAR or ED17 Medium Base Metal Halide lamp

EL 737C

EL 737F (Self Flanged)

Clear Reflector with Fresnel Lens and Metal Ring
O.D.: 9"



EL 757W

EL 757B

Baffle with Fresnel Lens and Metal Ring
O.D.: 9"



EL 783W

White Baffle with Reflector and Metal Ring
O.D.: 9"



EL 783B

Black Baffle with Reflector and Metal Ring
O.D.: 9"



EL 799C,G

EL 799F (Self Flanged)

Clear Reflector Trim with Metal Ring
O.D.: 9"



6" Architectural H.I.D. Metal Halide Downlights

39W, 50W, 70W, 100W, (Electronic Ballast)

- H.I.D. downlight designed for MH lamp with electronic ballast.
- Use only "Protected" type ED17 lamp in open trims.
- Adjustable hanger bar brackets accepts 1/2" EMT, C-Channels (CH26) or flat bars (FB27).
- Trim support adjusts 3/4" to accommodate different ceiling thickness.
- 120/277V magnetic ballast included. (347V available upon Request)
- U.L. damp location listed.
- U.L. feed through listed.
- Available with Quartz restrrike (upon request)

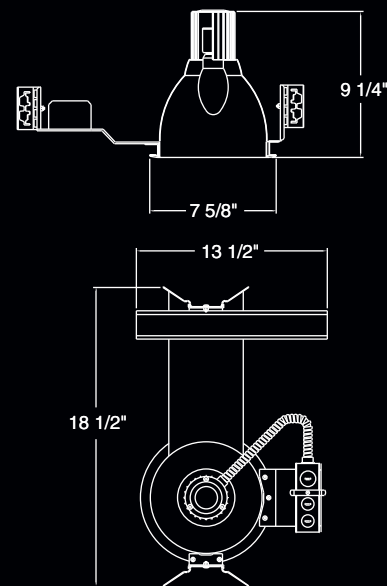

6" H.I.D. Downlight
Height: 9 1/4"
Ceiling Opening: 6"
Trim O.D.: 7 5/8"

E6M32E	39W M-130, PAR Medium Base Metal Halide lamp
E6M50E	50W M-110, ED17 Medium Base Metal Halide lamp
E6M70E	70W M-98, M-143, PAR or ED17 Medium Base Metal Halide lamp
E6M100E	100W M-90, PAR or ED17 Medium Base Metal Halide lamp

EL 737C
EL 737F (Self Flanged)
Clear Reflector with Fresnel Lens and Metal Ring
O.D.: 9"



EL 757W
EL 757B
Baffle with Fresnel Lens and Metal Ring
O.D.: 9"



EL 783W
White Baffle with Reflector and Metal Ring
O.D.: 9"



EL 783B
Black Baffle with Reflector and Metal Ring
O.D.: 9"



EL 799C, G
EL 799F (Self Flanged)
Clear Reflector Trim with Metal Ring
O.D.: 9"



6" Architectural H.I.D. High Pressure Sodium Downlights

50W, 70W, 100W (Magnetic Ballast)

- H.I.D. downlight designed for ED17 lamp with magnetic ballast.
- Adjustable hanger bar brackets accepts 1/2" EMT, C-Channels (CH26) or flat bars (FB27).
- Trim support adjusts 3/4" to accommodate different ceiling thickness.
- 120/277V magnetic ballast included. (347V available upon request)
- U.L. damp location listed.
- U.L. feed through listed.
- Available with Quartz restrike (upon request)

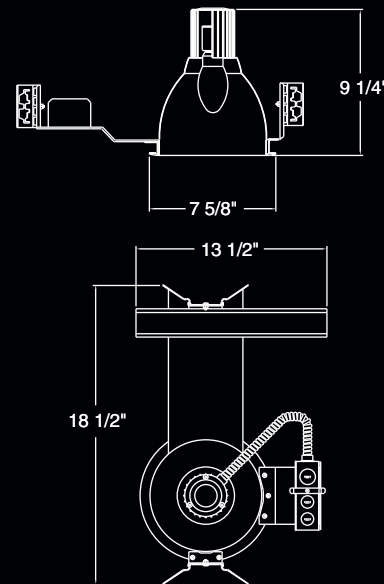

6" H.I.D. Downlight
Height: 9 1/4"
Ceiling Opening: 6"
Trim O.D.: 7 5/8"

E6S32	39W S-99 High Pressure Sodium Lamp, ED17 Medium Base
E6S50	50W S-68 High Pressure Sodium Lamp, ED17 Medium Base
E6S70	70W S-62 High Pressure Sodium Lamp, ED17 Medium Base
E6S100	100W S-54 High Pressure Sodium Lamp, ED17 Medium Base

EL 737C
EL 737F (Self Flanged)
Clear Reflector with Fresnel Lens and Metal Ring
O.D.: 9"



EL 757W
EL 757B
Baffle with Fresnel Lens and Metal Ring
O.D.: 9"



EL 783W
White Baffle with Reflector and Metal Ring
O.D.: 9"



EL 783B
Black Baffle with Reflector and Metal Ring
O.D.: 9"



EL 799C, G
EL 799F (Self Flanged)
Clear Reflector Trim with Metal Ring
O.D.: 9"



6" Architectural H.I.D. Recessed Downlights For PAR Lamp

- Recessed housing for metal halide PAR lamp with integral 120/277 magnetic ballast (347V available upon request).
- Adjustable hanger bar brackets accepts 1/2" EMT, C-Channels (CH26), or flat bars (FB27).
- Trim support adjusts 3/4" to accommodate different ceiling thickness.
- Lamp and hanger bars not included.
- Damp location listed.
- Feed through listed.

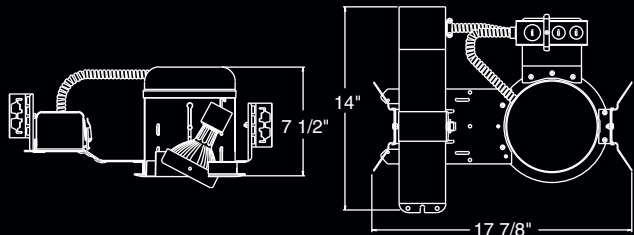

6" Adjustable H.I.D. Downlight, Magnetic
Height: 7 1/2" - Ceiling Opening: 6 1/2" - Trim O.D.: 7 1/4"



ELH7M35	39W Metal Halide M130
ELH7M50	50W Metal Halide ED17 M110
ELH7M70	70W Metal Halide PAR30 or PAR38 M98, M143
ELH7M100	100W Metal Halide PAR38 M90

Adjustable H.I.D. Recessed Downlights with PAR Lamp, Electronic

6"

- Recessed housing for metal halide PAR lamp with integral 120/277 Electronic ballast.
- Trim support adjusts 3/4" to accommodate different ceiling thickness.
- Includes 24" captive bar hangers.
- Lamp not included.
- Damp location listed.
- Feed through listed.

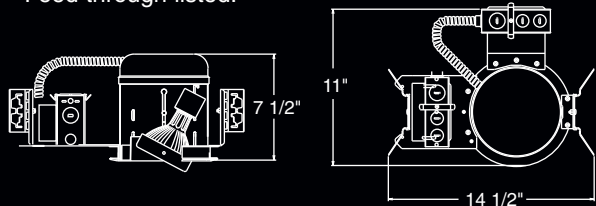

6" Adjustable H.I.D. Downlight, Electronic
Height: 7 1/2" - Ceiling Opening: 6 1/2" - Trim O.D.: 7 1/4"



ELH7M35E	39W Metal Halide PAR30 M130
ELH7M50E	50W Metal Halide ED17, M110
ELH7M70E	70W Metal Halide PAR30 or PAR38 M98, M143
ELH7M100E	100W Metal Halide PAR38 M90

Adjustable H.I.D. Recessed Remodel Downlights with PAR Lamp, Electronic

6"

- Recessed remodel housing for metal halide PAR lamp integral 120/277V electronic ballast.
- Lamp not included.
- Damp location listed.
- Feed through listed.

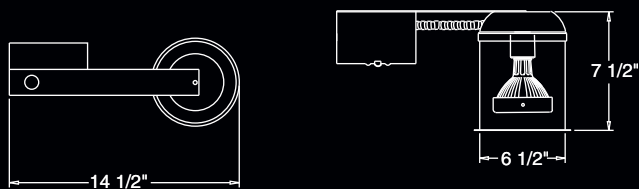

6" Adjustable H.I.D. Downlight, Electronic
Height: 7 1/2" - Ceiling Opening: 6 1/2" - Trim O.D.: 7 1/4"



ELRH7M35E	39W Metal Halide PAR30 M130
ELRH7M70E	70W Metal Halide PAR30 or PAR38 M98, M143
ELRH7M100E	100W Metal Halide PAR38 M90

6" H.I.D. Downlight Trims

EL 317G
EL 317W
Gimbal Ring
Lamp: PAR30
O.D.: 8"



ELS40C-RM7W
ELS40G-RM7W
Specular Reflector
with Metal Ring
Lamp: PAR38
O.D.: 7 1/4"



EL 317BZ
Gimbal Ring
Lamp: PAR30
O.D.: 8"

NEW!



EL 377W-RM7W
EL 377B-RM7W
Adjustable Reflector
Downlight with Metal Ring
Lamp: PAR 30
O.D.: 7 1/4"



EL 317CP
Gimbal Ring
Lamp: PAR30
O.D.: 8"

NEW!



EL 377C-RM7W
EL 377G-RM7W
Adjustable Reflector
with Metal Ring
Lamp: PAR30
O.D.: 7 1/4"



EL 318G
EL 318W
Gimbal Ring
Lamp: PAR30
O.D.: 8"



EL 477C-RM7W
EL 477B-RM7W
EL 477G-RM7W
EL 477W-RM7W
Adjustable Reflector
with Metal Ring
Lamp: PAR38
O.D.: 7 1/4"



ELS30B-RM7W
ELS30C-RM7W
ELS30G-RM7W
ELS30W-RM7W
Specular Reflector
with Metal Ring
Lamp: PAR30
O.D.: 7 1/4"



ELA99SC-RM7W
ELA99SG-RM7W
Specular
Cone Reflector
Lamp: PAR30
O.D.: 7 1/4"



ELM 30B-RM7G

ELM 30N

Baffle with
Gold Metal Ring
Lamp: PAR30
O.D.: 7 1/4"



ELM 40B-RM7W

ELM 40N

Black Stepped
Baffle with Metal Ring
Lamp: PAR38
O.D.: 7 1/4"



ELM 30W-RM7W

White Stepped Baffle
with White Metal Ring
Lamp: PAR30
O.D.: 7 1/4"



ELM 40W-RM7W

White Stepped
Baffle with Metal Ring
Lamp: PAR38
O.D.: 7 1/4"



Elco Lightings

ARCHITECTURAL CATALOG

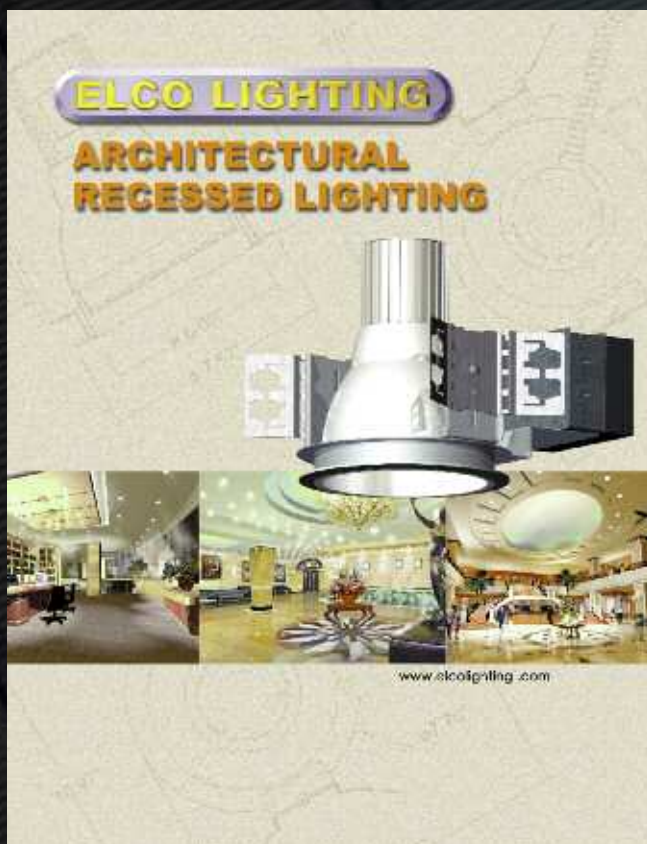

This catalog contains important information about:

- 4" Vertical Fluorescent Downlights
- 6" Vertical Fluorescent Downlights
- 8" Vertical Fluorescent Downlights
- 6" Horizontal Fluorescent Downlights
- 8" Horizontal Fluorescent Downlight
- 8" Wall Wash Fluorescent Downlights
- 6" Vertical Fluorescent Sloped Downlights
- 8" Vertical Metal Halide Downlights
- 6" Vertical High Pressure Sodium Downlights
- 8" Vertical High Pressure Sodium Downlights
- 6" Vertical Incandescent Downlights
- 8" Vertical Incandescent Downlights

To order our "Architctural Catalog" please contact us at Elco Headquarters.

4" Architectural H.I.D. Metal Halide Downlights for 20W, 39W PAR20, Electronic Ballast

- 4" Architectural MH new construction housing.
- Thermally protected H.P.F. Energy efficient Electronic ballast.
- 4KV Pulserated Medium base socket .
- Various trims for different application.
- Adjustable socket bracket for desirable lamp positioning
- U.L. damp location listed.
- U.L. feed through listed.



E4M20E	20W, M156, PAR20, Medium Base MH, 120V Electronic Ballast, new Construction housing
E4M35E	39W M130, PAR20, Medium Base MH, 120/277V Electronic Ballast, new Construction housing

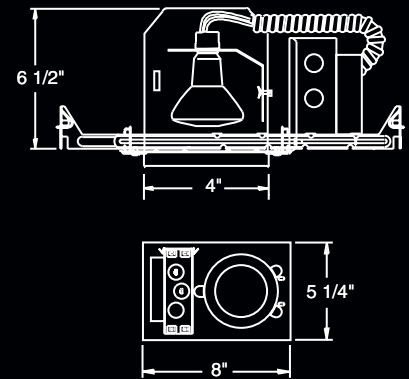

4" H.I.D. Downlight
 Height: 6 1/2"
 Ceiling Opening: 4 3/8"
 Trim O.D.: 4 3/4"

- 4" Architectural MH Remodel housing.
- Thermally protected H.P.F. Energy efficient Electronic ballast.
- 4KV Pulserated Medium base socket .
- Various trims for different application.
- Adjustable socket bracket for desirable lamp positioning
- U.L. damp location listed.
- U.L. feed through listed.

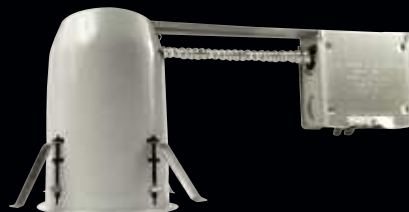

ER4M20E	20W, M156, PAR20, Medium Base MH, 120V Electronic Ballast, Remodeling housing
ER4M35E	39W M130, PAR20, Medium Base MH, 120/277V Electronic Ballast, Remodeling housing

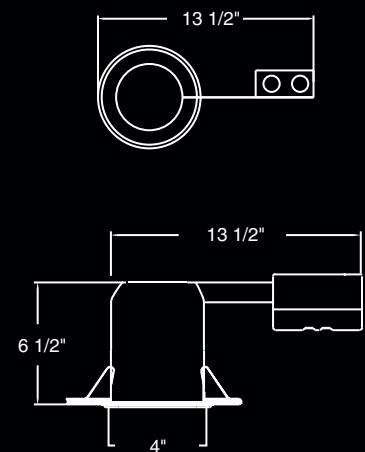

4" H.I.D. Downlight
 Height: 6 1/2"
 Ceiling Opening: 4 3/8"
 Trim O.D.: 4 3/4"

4" Architectural H.I.D. Metal Halide Downlights for 20W, 39W PAR20, Electronic Ballast (Cont.)

EL 977G
EL 977B
EL 977C
EL 977W

Reflector with
Lampholder Bracket
Lamp: 39W PAR20
O.D.: 4 3/4"



EL 995W
EL 995B
EL 995N
EL 995BZ
EL 995CP

Baffle with Lampholder
Bracket
Lamp: 39W PAR20
O.D.: 4 3/4"



EL 993MB
EL 993MW

Metal Step Baffle Trim
Lamp: 39W PAR20
O.D.: 4 3/4"



EL 998B
EL 998C
EL 998G
EL 998N
EL 998W

Eyeball Trim
Lamp: 40W-R16 R20-
50W
PAR20-50W
O.D.: 4 3/4"



EL 985N
EL 985B
EL 985F

Adjustable
Gimbal Ring Trim
Lamp: 39W PAR20
O.D.: 4 3/4"



EL 998BZ
Bronze Eyeball Trim
Lamp: R/PAR20-50W
R16-40W
O.D.: 4 3/4"

NEW!



EL 985BZ
Adjustable
Gimbal Ring Trim
Lamp: 39W PAR20
O.D.: 4 3/4"

NEW!



EL 998CP
Copper Eyeball Trim
Lamp: R/PAR20-50W
R16-40W
O.D.: 4 3/4"

NEW!



EL 985CP
Adjustable
Gimbal Ring Trim
Lamp: 39W PAR20
O.D.: 4 3/4"

NEW!



EL 999W
EL 999B
EL 999C
EL 999G
Reflector Trim
Lamp: 39W PAR20
O.D.: 4 3/4"



4" Architectural H.I.D. Metal Halide Downlights for 20W, MR16, MH Lamp Electronic Ballast

- 4" Contemporary MH downlight new construction and remodel housings.
- 20W, MR16, GX10 base lamp (not included).
- 4KV pulse rated, GX10 base socket.
- New construction or remodeling housing.
- 120V, H.P.F., energy efficient electronic ballast
- U.L. damp location listed.
- U.L. feed through listed.
- Available with Quartz restrike (upon request)

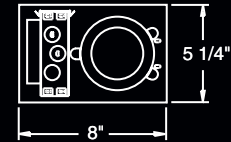
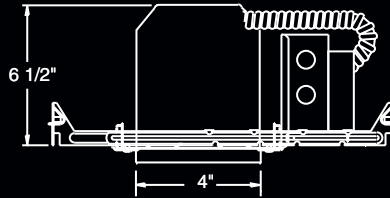

EL4M20E 20W, M156, MR16, GX10 base, 120V Electronic Ballast, new Construction housings

4" H.I.D. Downlight
Height: 6 1/2"
Ceiling Opening: 4 3/8"
Trim O.D.: 4 3/4"

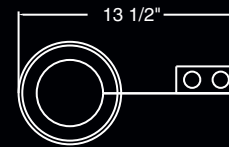
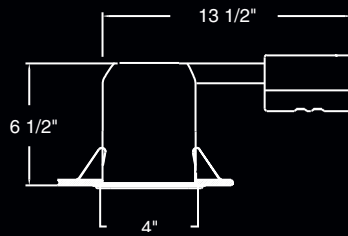
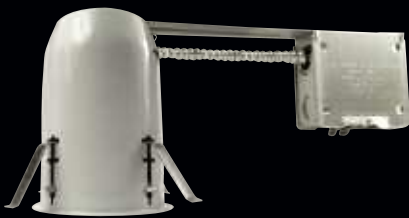

ELR4M20E 20W, M156, MR16, GX10 base, 120V Electronic Ballast, Remodel housings

4" H.I.D. Downlight
Height: 6 1/2"
Ceiling Opening: 4 3/8"
Trim O.D.: 4 3/4"

EL 1421C, W, G, CN, CP
Adjustable Specular Reflector
Lamp: MR16 20W, GX10
O.D.: 4 3/4"



EL 1422CP, B, C, W
45° Adjustable Wall Wash
Reflector Trim Rotate 350°
Lamp: MR16 20W, GX10
O.D.: 4 3/4"



EL 1429B, C, G, BN, CN
Adjustable Pinhole with Reflector
7/8" Aperture
Lamp: MR16 20W, GX10
O.D.: 4 3/4"



NEW!

EL 1433W, B
Gimbal Ring with Baffle
Lamp: MR16
20W, GX10
O.D.: 4 3/4"



EL 1488B, N, W, BZ, CP
Adjustable Spot Trim
Angle: 30°
Lamp: MR16, 20W, GX10
O.D.: 4 3/4"



EL 1493BZ
Adjustable Baffle Trim,
All Bronze
25° Angle
Lamp: MR16-75W
O.D.: 4 3/4"



NEW!

Undercabinet

Eico Lighting has improved and broadened its undercabinet line based on input from home-owners, architects, contractors, builders and distributors. Our assortment of undercabinet products has benefited from this working relationship and represents the latest in efficient, low cost designs. For use in jewelry and exhibit cases, bookcases, cove lighting, cubicle lighting, boat and RV interiors, staircases, art galleries and more.

- HALOGEN
- XENON
- FLUORESCENT
- LINE VOLTAGE OR LOW VOLTAGE
- DECOLUME
- MINI LIGHTS
- DURALIGHTS

181-198



Electronic Fluorescent Undercabinet

EUN 12E - w/o Lamp
EUN 12EL - with Lamp
White Fluorescent
120V Electronic Ballast
Lamp; (1) F8T5
12-1/4" x 5" x 1"



EUN 21E - w/o Lamp
EUN 21EL - with Lamp
White Fluorescent
120V Electronic Ballast
Lamp; (1) F13T5
21-1/4" x 5" x 1"



EUN 24E - w/o Lamp
EUN 24EL - with Lamp
White Fluorescent
120V Electronic Ballast
Lamp; (2) F8T5
24-1/2" x 5" x 1"



EUN 32E - w/o Lamp
EUN 32EL - with Lamp
White Fluorescent
120V Electronic Ballast
Lamp; (1) F8T5 & F13T5
33-1/2" x 5" x 1"



EUN 42E - w/o Lamp
EUN 42EL - with Lamp
White Fluorescent
120V Electronic Ballast
Lamp; (2) F13T5
42-1/2" x 5" x 1"



- This very low profile, 1" deep series, is available in five different lengths which make it an ideal choice for installation under cabinets.
- The housing is die formed of 20 gauge, high quality cold rolled steel with a baked on high gloss white enamel finish. This housing comes standard with two keyhole slots and 1/2" knockouts on each end as well as on top and rear which allow for easy wiring installation and mounting as a safety feature, all of the exposed edges have been deburred.

- Cleaning and relamping is made easy with the flexible white diffuser which easily snaps in and out. This diffuser is constructed, in one piece, of ribbed opaque acrylic which allows for excellent light distribution.
- This unit is equipped with a power factor corrected 120 volt electronic ballast which operates 60% cooler than a conventional preheat ballast, it also reduces operation noise and eliminates lamp flicker.
- Convenient outlet, power switch and cord available upon request, not included.

Slim Line Fluorescent Undercabinet (Linkable)

EUS8W

White Fluorescent
120V Electronic Ballast
Lamp: (1) F8T5 (included)
1 11/16" x 7/8" x 13 1/2"

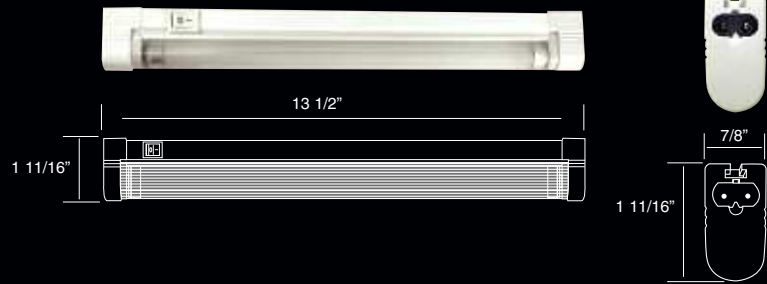

EUS14W

White Fluorescent
120V Electronic Ballast
Lamp: (1) F14T5 (included)
1 11/16" x 7/8" x 23 5/8"



EUS21W

White Fluorescent
120V Electronic Ballast
Lamp: (1) F21T5 (included)
1 11/16" x 7/8" x 35 5/8"

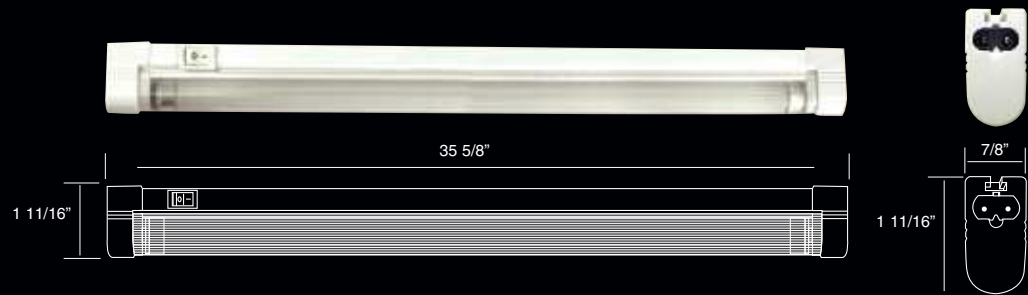

EUS28W

White Fluorescent
120V Electronic Ballast
Lamp: (1) F28T5 (included)
1 11/16" x 7/8" x 47 1/2"

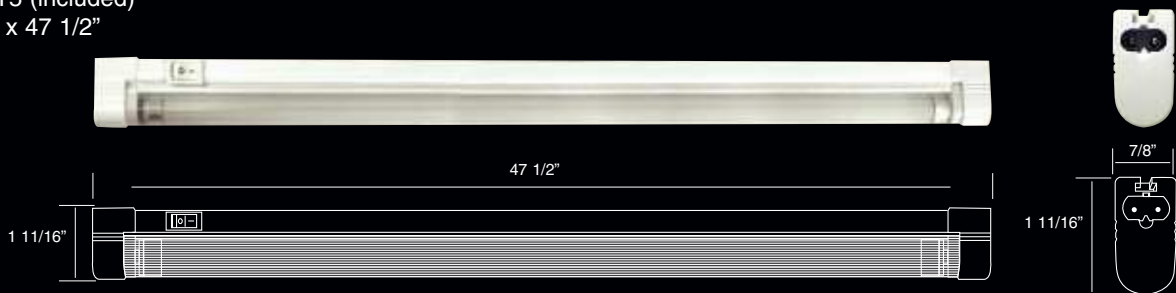

- Low Profile Energy efficient Fluorescent undercabinet lights
- 120V Electronic Ballast
- On/off switch on each unit
- 5' cord and plug, (included)
- T5 lamp included
- White Polycarbonate body, ribbed clear acrylic lens
- Mini connectors for flush unit to unit installation (included)
- U.L. Listed (as portable lamp fixture)

Options

EUSC6:	6" linking cable
EUSC12:	10" linking cable
EUSC24:	24" linking cable
EUSC36:	39" linking cable

Miniature Electronic Fluorescent

EUB 12E - w/o Lamp

EUB 12EL - with Lamp

EUB 12EN - w/o Lamp, Brushed Nickel Housing

White Fluorescent

120V Electronic Ballast

Lamp; (1) F8T5

12-1/4" x 2-1/2" x 1"

NEW!



EUB 21E - w/o Lamp

EUB 21EL - with Lamp

EUB 21EN - w/o Lamp, Brushed Nickel Housing

White Fluorescent

120V Electronic Ballast

Lamp; (1) F13T5

21-1/4" x 2-1/2" x 1"

NEW!



EUB 24E - w/o Lamp

EUB 24EL - with Lamp

EUB 24EN - w/o Lamp, Brushed Nickel Housing

White Fluorescent

120V Electronic Ballast

Lamp; (2) F8T5

24-1/2" x 2-1/2" x 1"

NEW!

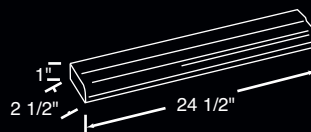

EUB 32E - w/o Lamp

EUB 32EL - with Lamp

EUB 32EN - w/o Lamp, Brushed Nickel Housing

White Fluorescent

120V Electronic Ballast

Lamp; (1) F8T5 & F13T5

33-1/2" x 2-1/2" x 1"

NEW!

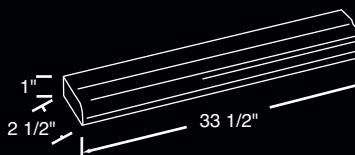

EUB 42E - w/o Lamp

EUB 42EL - with Lamp

EUB 42EN - w/o Lamp, Brushed Nickel Housing

White Fluorescent

120V Electronic Ballast

Lamp; (2) F13T5

42-1/2" x 2-1/2" x 1"

NEW!

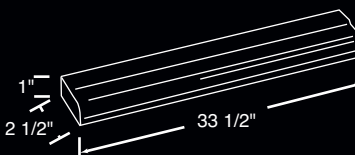

Incandescent Halogen Undercabinet

EUC22W - White Housing

EUC22B - Black Housing

Miniature Undercabinet
Line Voltage Halogen Light
with 2-level on/off switch (not
installed) Lamp; (2) 25 Watt,
120 Volt, T4 Lamp Included,
U.L. Listed 20-3/4" x 2 1/4" x 1"



EUC33W - White Housing

EUC33B - Black Housing

Miniature Undercabinet
Line Voltage Halogen Light
with 2-level on/off switch (not
installed) Lamp; (3) 25 Watt,
120 Volt, T4 Lamp Included,
U.L. Listed 20-3/4" x 2 1/4" x 1"



EUC41W

EUC41B

Line Voltage
Lamp; (1) 35W, 120V, G8,
JCD Lamp (Lamp Included)
Includes 2-level on/off switch
Dimmable
1-1/4" x 5" x 8"

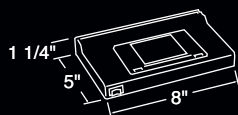

EUC42W

EUC42B

Line Voltage
Lamp; (2) 35W, 120V, G8,
JCD Lamp (Lamp Included)
Includes 2-level on/off switch
Dimmable
1-1/4" x 5" x 16"

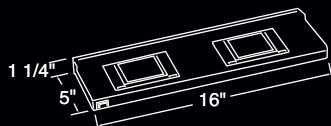

EUC43W

EUC43B

Line Voltage
Lamp; (3) 35W, 120V, G8
JCD Lamp (Lamp Included)
Includes 2-level on/off switch
Dimmable
1-1/4" x 5" x 24"

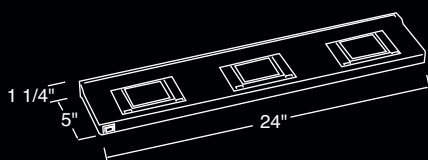

Incandescent Halogen Undercabinet (Cont.)

EUC 51W

NEW!

EUC 51BZ Bronze HousingLine

Line Voltage

Lamp; (1) 35W, 120V, G8

JCD Lamp (Lamp Included)

Dimmable w/ glass diffused lens

Includes 2-level on/off switch

Dimmable

1-1/4" x 5" x 8"



EUC 52W

NEW!

EUC 52BZ Bronze Housing

Line Voltage

Lamp; (2) 35W, 120V, G8

JCD Lamp (Lamp Included)

Dimmable w/ glass diffused lens

Includes 2-level on/off switch

1-1/4" x 5" x 16"



EUC 53W

NEW!

EUC 53BZ Bronze Housing

Line Voltage

Lamp; (3) 35W, 120V, G8

JCD Lamp (Lamp Included)

Dimmable w/ glass diffused lens

Includes 2-level on/off switch

1-1/4" x 5" x 24"



EUC 54W

NEW!

EUC 54BZ Bronze Housing

Line Voltage

Lamp; (4) 35W, 120V, G8

JCD Lamp (Included)

Dimmable w/ glass diffused lens

Includes 2-level on/off switch

1-1/4" x 5" x 32"



NEW!
EUZ 56BZ Bronze Housing
EUZ 56W
 Low Voltage Undercabinet
 with diffused glass lens
 and electronic transformer
 Lamp; (1) 18W, 12V Wedge Base
 Xenon lamp included
 Includes 2-level on/off switch; dimmable
 1-1/4" x 5" x 8"

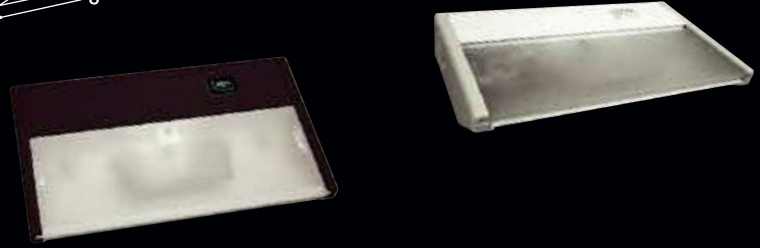

NEW!
EUZ 57BZ Bronze Housing
EUZ 57W
 Low Voltage Undercabinet
 with diffused glass lens
 and electronic transformer
 Lamp; (2) 18W, 12V Wedge Base
 Xenon lamp included
 Includes 2-level on/off switch; dimmable
 1-1/4" x 5" x 16"

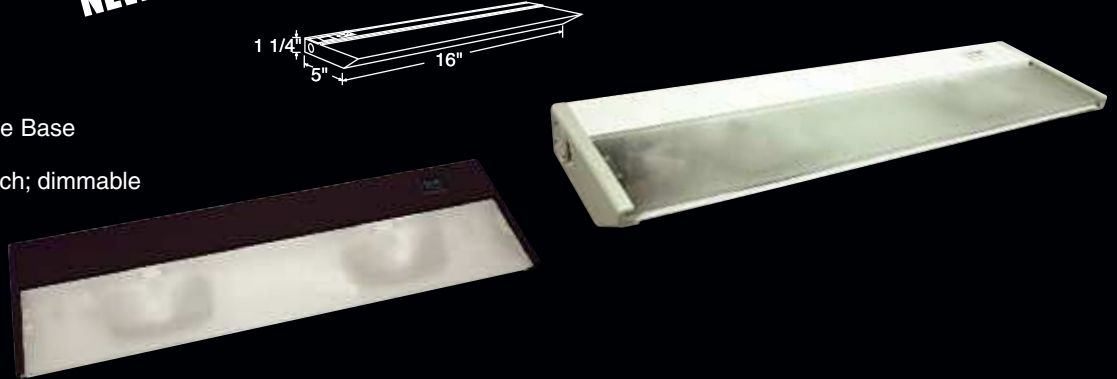

NEW!
EUZ 58BZ Bronze Housing
EUZ 58W
 Low Voltage Undercabinet
 with diffused glass lens
 and electronic transformer
 Lamp; (3) 18W, 12V Wedge Base
 Xenon lamp included
 Includes 2-level on/off switch; dimmable
 1-1/4" x 5" x 24"

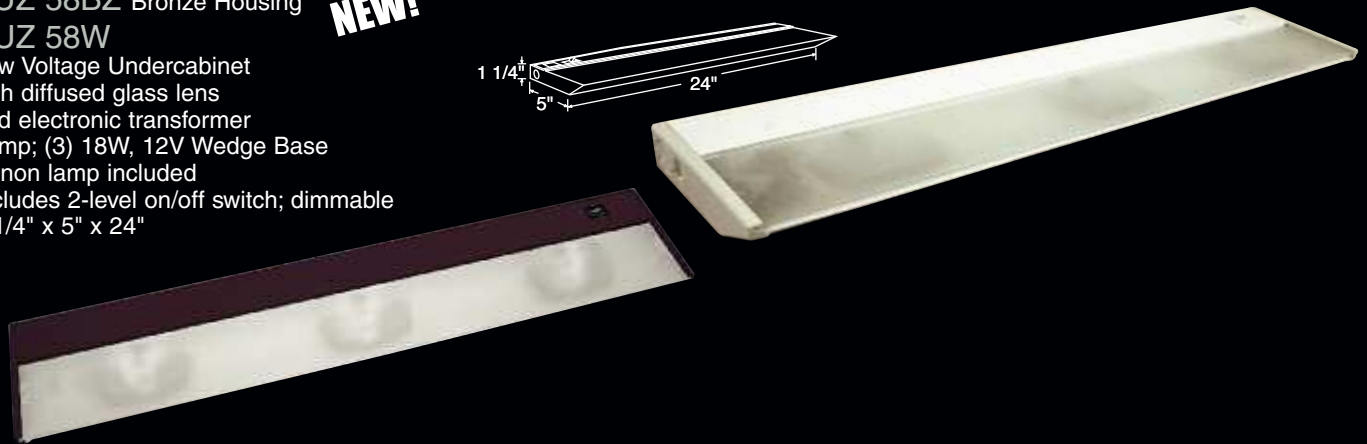

NEW!
EUZ 59BZ Bronze Housing
EUZ 59W
 Low Voltage Undercabinet
 with diffused glass lens
 and electronic transformer
 Lamp; (4) 18W, 12V Wedge Base
 Xenon lamp included
 Includes 2-level on/off switch; dimmable
 1-1/4" x 5" x 32"



Low Voltage Decolume Light



EDSC-3 Decolume Strip Light

Decolume Strip Light is a flexible, miniature lighting product. Using the technology of low voltage halogen lamps, Decolume Strip Light can accommodate 5 watt and 10 watt festoon lamps as well as 20 to 35 watt MR-11 lamps. Festoon lamps can be used for straight line decoration while the MR-11 socket allows for point/spot light and is easily turned into 0 to 180 degree concave and convex form to accent any application.

- Can be used with 12V or 24V transformers and bulbs.
- No effect on other lights in chain if one
- Supplied with adhesive pad for each socket.
- Decolume Strip Light can be applied on the (10W, MAX) wall, curves, cabinets, spot lighting, boat interiors, elevators and more.
- 3" bulb spacing (4 bulbs per foot).
- Reflectors are available for festoon lamps for better brightness.

Decolume Parts

EPD-2
Terminal block



EPD-3
Terminal block



EPD-4
Mounting clip



EPD-5 5W 12V
EPD-10 10W 12V
Festoon incandescent lamp



EPD5-24 5W 24V
EPD10-24 10W 24V
Festoon incandescent lamp



EPD-5-Z 5W 12V
EPD-10-Z 10W 12V
Xenon Festoon Lamp



EPD-6
End cap



EPD-9
Two piece lampholder kit



EPD-11
Cross connector



EPD-12
Mounting adhesive pad



EPD-20 20W 12V
EPD-35 35W 12V
MR11 Halogen lamp



EDSC-4, EDSC-4L, EDSC-4L-24 Architectural Covelite



- Low Voltage Architectural Covelite for xenon wedge base lamp.
- 4" bulb spacing (3 bulbs per foot)
- Can be used with 12 or 24V supply
- 5 or 10W xenon lamp (12 or 24V)
- Mini reflectors under each lamp for better directional light

EDSC-4
(without lamp)

- WB-5-Z
Xenon lamp, 5W, 12V, wedge base, clear

EDSC-4L
(12V clear lamp included)

- WB-5-ZF
Xenon lamp, 5W, 12V, wedge base, Frosted

EDSC-4L-24
(24V clear lamp included)

- WB-5Z-24
Xenon lamp, 5W, 24V, wedge base, Clear

EPD-2
Terminal block



- WB-5-ZF-24
Xenon lamp, 5W, 24V, wedge base, Frosted

EPD-4
Mounting clip



- WB-10-Z
Xenon lamp, 10W, 12V, wedge base, Clear

- WB-10-ZF
Xenon lamp, 10W, 12V, wedge base, Frosted

EPD-6
End cap



- WB-10-Z-24
Xenon lamp, 10W, 24V, wedge base, Clear

- WB-10-ZF-24
Xenon lamp, 10W, 24V, wedge base, Frosted

Mini Low Voltage Halogen Downlight

- Mini Light provides an excellent source wherever a small powerfull light is needed.
- Mini light may be recessed mounted.
- Can be dimmed with low voltage electronic dimmer. Maybe used with remote trasformers.
- 18" lead wires

- Thermally Protected Housing
- Indoor lighting; Non IC rated Bi-Pin socket.
- All housing supplied with housing.

MR11 Lamp

E200

Metal housing only for E222



E221N E221B E221G E221W

Recessed Chrome Reflector with Metal Ring and Housing.

- Lamp: 20W MR11
- Lamp not included.
- Includes MR11 Socket
- E.T.L. listed
- Cutout: 2 1/2"
- Trim O.D.: 2 7/8"

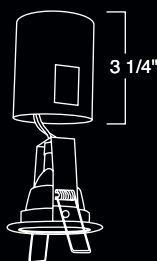

E222G E222B E222C E222N E222W

Miniature Aluminum Diecast Gimbal Ring with Housing.

- Lamp: 20W MR11
- Lamp not included.
- Includes MR11 Socket
- E.T.L. listed
- Cutout: 2 3/8"
- Trim O.D.: 2 7/8"

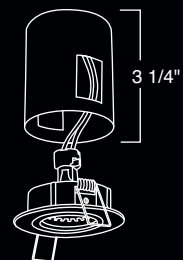

NEW!

E222BZ

Miniature Aluminum Diecast Gimbal Ring with Housing.

- Lamp: 20W MR11
- Lamp not included.
- Includes MR11 Socket
- E.T.L. listed
- Cutout: 2 3/8"
- Trim O.D.: 2 7/8"

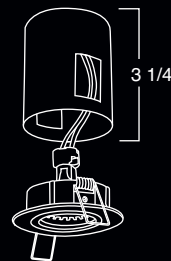

NEW!

E222CP

Miniature Aluminum Diecast Gimbal Ring with Housing.

- Lamp: 20W MR11
- Lamp not included.
- Includes MR11 Socket
- E.T.L. listed
- Cutout: 2 3/8"
- Trim O.D.: 2 7/8"

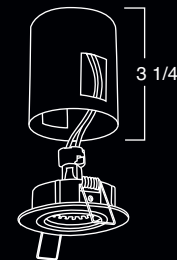

E233W

Mini Diecast Gimbal Ring with Decorative Glass Ring.

- Lamp: 35W MR16
- Lamp not included.
- MR16 Socket is included
- Cutout: 3 1/8"
- Trim O.D.: 3 3/4"

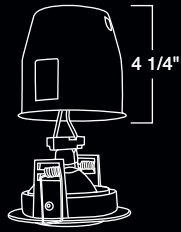

NEW!

E233CP

Mini Diecast Gimbal Ring with Decorative Glass Ring.

- Lamp: 35W MR16
- Lamp not included.
- MR16 Socket is included
- Cutout: 3 1/8"
- Trim O.D.: 3 3/4"

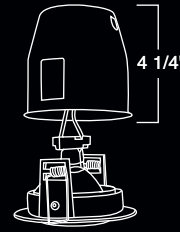

E233G

E233B

Mini Diecast Gimbal Ring with Decorative Glass Ring.

- Lamp: 35W MR16
- Lamp not included.
- MR16 Socket is included
- Cutout: 3 1/8"
- Trim O.D.: 3 3/4"

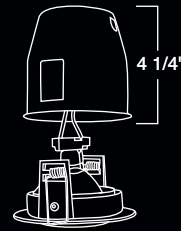

E234G

E234N

Mini Shower Trim with Frosted Glass and Rubber Gasket.

- Lamp: 35W MR16
- Lamp not included.
- MR16 Socket is included
- Cutout: 3 1/8"
- Trim O.D.: 3 3/4"

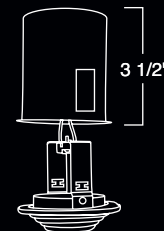

E233N

E233C

Mini Diecast Gimbal Ring with Decorative Glass Ring.

- Lamp: 35W MR16
- Lamp not included.
- MR16 Socket is included
- Cutout: 3 1/8"
- Trim O.D.: 3 3/4"

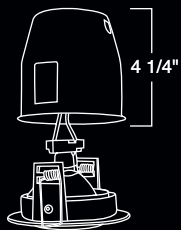

E234B

E234W

Mini Shower Trim with Frosted Glass and Rubber Gasket.

- Lamp: 35W MR16
- Lamp not included.
- MR16 Socket is included
- Cutout: 3 1/8"
- Trim O.D.: 3 3/4"

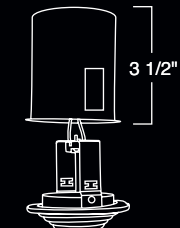

NEW!

E233BZ

Mini Diecast Gimbal Ring with Decorative Glass Ring.

- Lamp: 35W MR16
- Lamp not included.
- MR16 Socket is included
- Cutout: 3 1/8"
- Trim O.D.: 3 3/4"

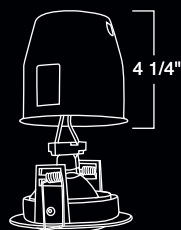

E300

Metal housing only, for E233

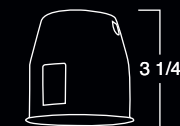

Mini Low Voltage Halogen Downlight (Cont.)

- Mini Light provides an excellent source wherever a small powerfull light is needed.
- Mini light may be surface mounted.
- Maybe used with remote trasformers.
- 18" lead wires

- Indoor lighting; E.T.L. listed; Bi-Pin socket.
- All housing supplied with housing.

E225B E225W

- Miniature Downlight Black with Frosted Glass Globe.
- Lamp: 20W JC lamp included
 - E.T.L. listed
 - Cutout: 1 7/8"
 - Trim O.D.: 2 5/8"



E226WS E226BS E226GS

- Miniature Downlight with Sanded lens.
- Lamp: 20W JC lamp included
 - E.T.L. listed
 - Height: 7/8"
 - Cutout: 2 1/4"
 - Trim O.D.: 2 5/8"



E225N

- Miniature Downlight Brushed Nickel with Frosted Glass Globe.
- Lamp: 20W JC lamp included
 - E.T.L. listed
 - Cutout: 1 7/8"
 - Trim O.D.: 2 5/8"



E226B E226W

- Miniature Downlight with Clear lens.
- Lamp: 20W JC lamp included
 - E.T.L. listed
 - Height: 7/8"
 - Cutout: 2 1/4"
 - Trim O.D.: 2 5/8"



E225R

- Miniature Downlight with Rose Globe.
- Lamp: 20W JC lamp included
 - E.T.L. listed
 - Cutout: 1 7/8"
 - Trim O.D.: 2 5/8"



E226C E226G

- Miniature Downlight with Clear lens.
- Lamp: 20W JC lamp included
 - E.T.L. listed
 - Height: 7/8"
 - Cutout: 2 1/4"
 - Trim O.D.: 2 5/8"



Mini Low Voltage Halogen Downlight (Cont.)

NEW!

E228BZ

Miniature Downlight
with Clear Lens,

- Lamp: JC-20W
- Lamp Included
- E.T.L. Listed
- Height: 7/8"
- Cutout: 2 1/4"
- 2 5/8" Trim O.D.



E228C

E228G

Miniature Downlight
with Clear lens.

- Lamp: 20W JC lamp included
- E.T.L. listed
- Height: 7/8"
- Cutout: 2 1/4"
- Trim: O.D.: 2 5/8"



NEW!

E228CP

Miniature Downlight
with Clear Lens,

- Lamp: JC-20W
- Lamp Included
- E.T.L. Listed
- Height: 7/8"
- Cutout: 2 1/4"
- 2 5/8" Trim O.D.



E228BS

E228GS

E228NS

E228WS

Miniature Downlight
with Sanded lens.

- Lamp: 20W JC lamp included
- E.T.L. listed
- Height: 7/8"
- Cutout: 2 1/4"
- Trim: O.D.: 2 5/8"



E228W

E228B

Miniature Downlight
with Clear lens.

- Lamp: 20W JC lamp included
- E.T.L. listed
- Height: 7/8"
- Cutout: 2 1/4"
- Trim: O.D.: 2 5/8"



E228N

Miniature Downlight
with Clear lens.

- Lamp: 20W JC lamp included
- E.T.L. listed
- Height: 7/8"
- Cutout: 2 1/4"
- Trim: O.D.: 2 5/8"



E326B

E326C

E326G

E326W

3 mini-halogen trims
(E226) and 3 housings.
60W transformer with
6" plug in cord (ETR60-PLG)
Quick cord & connection
installed no wiring required.
Choice of colors are white,
black, chrome, or gold.



Undercabinet Accessories

- EBA 12E Electronic ballast for one T5 lamp
- EBA 21E Electronic ballast for two T5 lamp
- EBA 26E Electronic ballast for one T5 lamp
- EBA 42E Electronic ballast for one T5 lamp



Accessories

- WB-18-Z 18W, Xenon Lamp
12V, Wedge Base, Clear



- EUOUT Convenience Outlet
For EUN



- EUSWT1 (for EUN)
- EUSWT2 (for EUB) Rocket Switch
- EUSWT3 (for EUC and EUZ, 2-level ON/OFF)



- EUCRD 6' Cord and Plug



Lamps

- JC-20 20W, 12V lamp for E226, E228
- JC-25 25W, 120V lamp for EUC22, EUC33
- JC-35 35W, 120V lamp for EUC51, EUC52, EUC53
- JC-20-Z 20W, 12V Xenon Bi-pin lamp
for E226 or E228



Bulbs

- F8T5 8 Watt T5 Lamp
- F13T5 13 Watt T5 Lamp
- F14T5 14 Watt T5 Lamp, 4100°K
- F21T5 21 Watt T5 Lamp, 4100°K
- F28T5 28 Watt T5 Lamp, 4100°K



Lens

- EUL 12 12" Lens, for EUN12E
- EUL 21 21" Lens, for EUN21E
- EUL 24 24" Lens, for EUN24E
- EUL 32 32" Lens, for EUN32E
- EUL 42 42" Lens, for EUN42E



- EUS 8L Lens for EUS8
- EUS 14L Lens for EUS14
- EUS 21L Lens for EUS21
- EUS 28L Lens for EUS28



- EUL 51 Glass Lens for EUC51 & EUZ56
- EUL 52 Glass Lens for EUC52 & EUZ57
- EUL 53 Glass Lens for EUC53 & EUZ58
- EUL 54 Glass Lens for EUC54 & EUZ59

- EUBL 12 Lens for EUB12E
- EUBL 21 Lens for EUB21E
- EUBL 24 Lens for EUB24E
- EUBL 32 Lens for EUB32E
- EUBL 42 Lens for EUB42E



The 2 Wires Fixing Duralight with its excellent workmanship and perfect combination of components have won certificates of America U.L. Standard and Canadian CSA Standard. This product is widely used in the illumination and decoration of the outlines and patterns of buildings.

The core is flexible, unbreakable, and pressure resistant every inch withstands 200 Lbs of pressure, and it endures a temperature range of -20°C to 60°C. The PVC material with ultraviolet absorbent and heat-resistant additives effectively prevent decolorization and hardening, 1/2" diameter.

Duralight 2 Wire

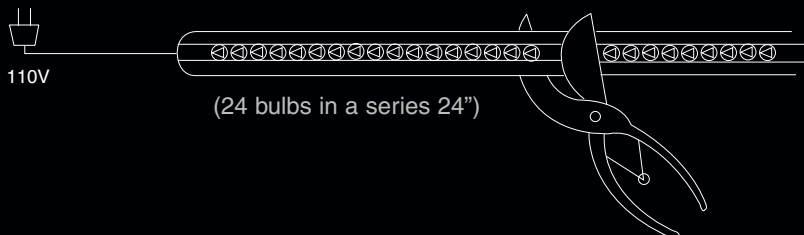
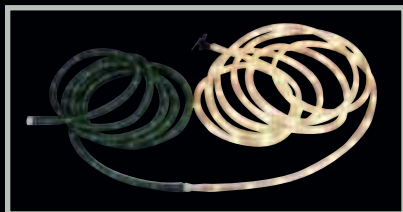

EDU2 120V 2-Wire Duralight, must be cut every 2'

EDU2LV 12V Low Voltage 2-Wire Duralight, must be cut every 6"



EDU2LV
12V Low Voltage Duralight Each roll includes 5 sets of power cords, power connectors, end caps, splice connectors and 50 mounting clips.

NEW! EDU2LED
120V, 2 wire LED Duralight Energyefficient, 0.8 w/ft., long lamp life must be cut in 3' increments max run: 300ft

EDU2 Duralight 2-wire Clear
EDU2 RD Duralight 2-wire Red
EDU2 GR Duralight 2-wire Green
EDU2 BL Duralight 2-wire Blue
EDU2 FR Duralight 2-wire Frosted

NOTE: Other Colors available with special order

Duralight 3 Wire

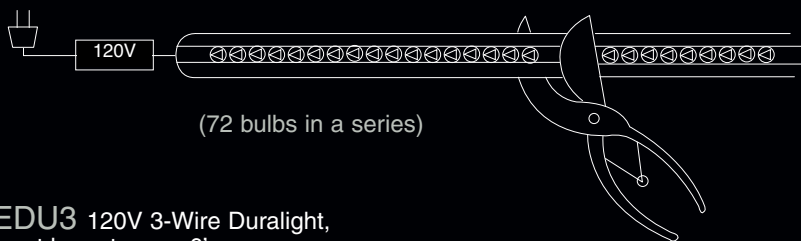

DURALIGHT - 3 Wire Clear Other Colors available with special order.

EDU3 120V 3-Wire Duralight, must be cut every 6'

Controllers

ECN2

- Use for EDU2 Duralight (2 Wires)
- Auto Exchange
- Flashing in different speeds
- Full light up - Full light off
- Audio Control
- 120V1500W



ECN3

- Use for EDU3 Duralight (3 Wires)
- 3 Wires chasing modes
- Auto Exchange
- Flashing audio control
- 120V1250W



ECN5

- Use for EDU2 Duralight (2 Wire)
- 3 Wires chasing modes
- 120V, 2.8A



Parts

EPC2 Power Cord for EDU2
EPC3 Power Cord for EDU3



EPT2 T-Connector for EDU2
EPT3 T-Connector for EDU3



EPEN End Cap



EPMT Plastic Mounting Clip



EPCH 6ft. Channel



EPN2 Power Connector for EDU2



EPS2 Splice Connector for EDU2



Duralight Specs

	EDU2 (2WIRE)	EDU2 LOW VOLTAGE	EDU3 (3WIRE)
VOLTAGE	110V-120V	12V	110V-120V
BULB SPACING	1"	1"	1"
NUMBER OF BULBS PER FOOT	12 Bulbs	12 Bulbs	12 Bulbs
VOLTAGE / MAPS WATTAGE	5.0V 0.05A 0.25W/Lamp; 3.0W/FT.	2V 0.14A 0.28W/Lamp 3.36W/FT.	3.5V 0.05A 0.175W/Lamp; 2.1W/FT.
BULB LIFE	25,000 HRS	25,000 HRS	25,000 HRS

ETR 240

250VA magnetic transformer
 L x W: 9 1/2" x 4 1/4"
 U.L. listed
 Input: 120/240V AC
 Output: 12/24V AC



LET 75

12V 75VA Miniature Ballast. UL
 Recognized
 2 1/8" x 1 1/4" x 3/4"

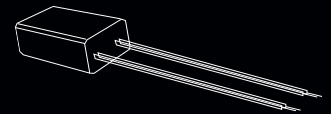

ETR 480

480VA magnetic transformer
 L x W: 11 1/4" x 5"
 U.L. listed
 Input: 120/240V AC
 Output: 12/24V AC



LVT 303-DC

300VA/12V Mini Direct Current
 Electronic Transformer
 with junction box
 9 3/8" x 1 5/8" x 1 1/2"
 U.L. Listed

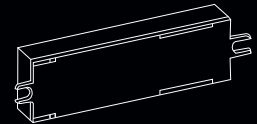

LET 303

300VA/12V Mini electronic
 transformer
 U.L. Recognized
 5 1/4" x 1 1/2" X 1 5/8"

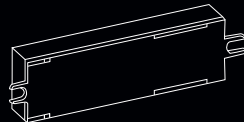

LET 151

150VA/12V Mini Electronic
 Transformer
 L x W: 3 1/4" x 1 1/2"
 U.L. Recognized



LVT 303

300VA/12V, Mini electronic
 transformer with Junction Box
 U.L. Listed
 9 3/8" x 1 5/8" x 1 1/2"

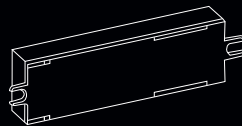

LVT 151

150VA Mini Electronic
 Transformer with Junction Box
 6 1/2" X 1 1/2" X 1 3/8"
 U.L. Listed



LVT 303-24

300VA/24V Mini electronic
 transformer with Junction Box
 U.L. Listed
 9 3/8" x 1 5/8" x 1 1/2"

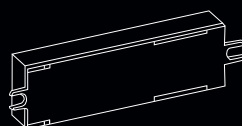

LET 100

For Duralight
 Magnetic Transformer
 for outdoor use.
 L x W: 5 3/4" x 3 3/4"
 100VA, 12V

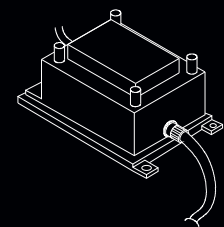

Electronic Transformers

ETR 50

Electronic Transformer
50VA/120V/60Hz
3 1/8" x 1 7/8" x 1 1/4"
Input AC 120V
Output 12V/50VA
U.L. Recognized



ETR 60

Electronic Transformer
60VA/120V/60Hz- Class II
3 1/8" x 1 7/8" x 1 1/4"
Input AC 120V
Output AC 12V/60VA
U.L. Recognized

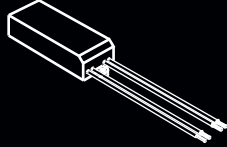

ETR60-PLG

Electronic Transformer
60VA/120V/60Hz
3 3/8" x 1 7/8" x 1 1/4"
Input AC 120V
Output AC 12V/60VA
U.L. Recognized

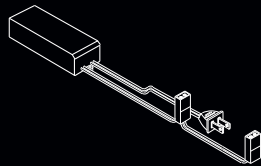

ETR 75

Electronic Transformer
75VA/120V/60Hz
3 1/8" x 1 7/8" x 1 1/4"
Input AC 120V
Output AC 12V
U.L. Recognized



ETR80

Electronic Transformer
Input:120V
Output: 12V AC, 80VA
U.L. Recognized

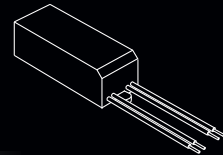

ETR80-PLG

Direct Plug-in
Electronic Transformer
80VA/120V/60Hz
3 3/8" x 1 1/4" x 13/16"
Input AC 120V
Output AC 12V
U.L. recognized
FCC approved
U.L. Recognized

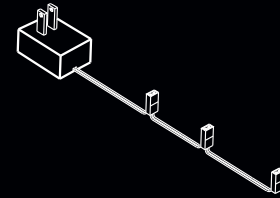

ETR 105

Electronic Transformer
105VA/120V/60Hz
5 1/8" x 1 3/4" x 1 3/8"
Input AC 120V
Output AC 12V
U.L. Recognized



ETR 150

Electronic Transformer
150VA/120V/60Hz
5 1/8" x 1 3/4" x 1 3/8"
Input AC 120V
Output AC 12V/150VA
U.L. Recognized



Magnetic Transformers

ETR 12

Low Voltage Magnetic
Transformer
120V/12V - 50W
U.L. Recognized

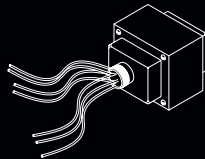

ETR 12-75

Low Voltage Magnetic
Transformer
120V/12V - 75W

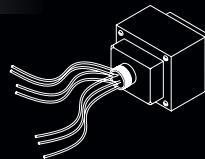

ETR-277

Steps 277V line voltage
down to 120V/300VA fixture
operating voltage.
Secures to 1/2" junction
box knockout.

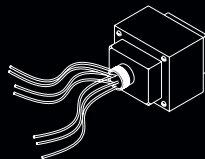

P75-7

Steps 277V line voltage
down to 12V 75W fixture
operating voltage.
Secures to 1/2" junction
box knockout.

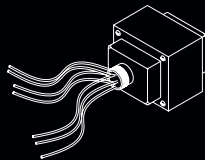

ETR12-277

Low Voltage Magnetic
Transformer
277V/12V - 50W
Secures to 1/2" Junction
box knockout

NEW!

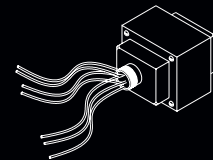

ETRK-50

Low Voltage Magnetic
Transformer Retrofit Kit
120V/12V - 50W
Medium screw base
Fits most 6" and 5" Recessed
Downlight housing.



ETRK-50E

Low Voltage Electronic
Transformer Retrofit Kit
120V/12V - 50W
Short circuit protection
Medium screw base
Fits most 6" and 5" Recessed
Downlight housing.



Recessed Wall Mount Lighting

- STEP LIGHTS
- BRICK LIGHTS
- MINI-STEP LIGHTS

Now Elco offers a wider range of products in this category utilizing different light source technologies such as incandescent, fluorescent and LED's. These products are designed for outdoor or indoor installations in IC or non-IC, brick, wet or poured concrete applications. Our new line of mini-step lights has combined advantages of ease of installation and versatility as well as energy efficiency (for LED models). These products are available in nickel and bronze finishes as well.

199-207

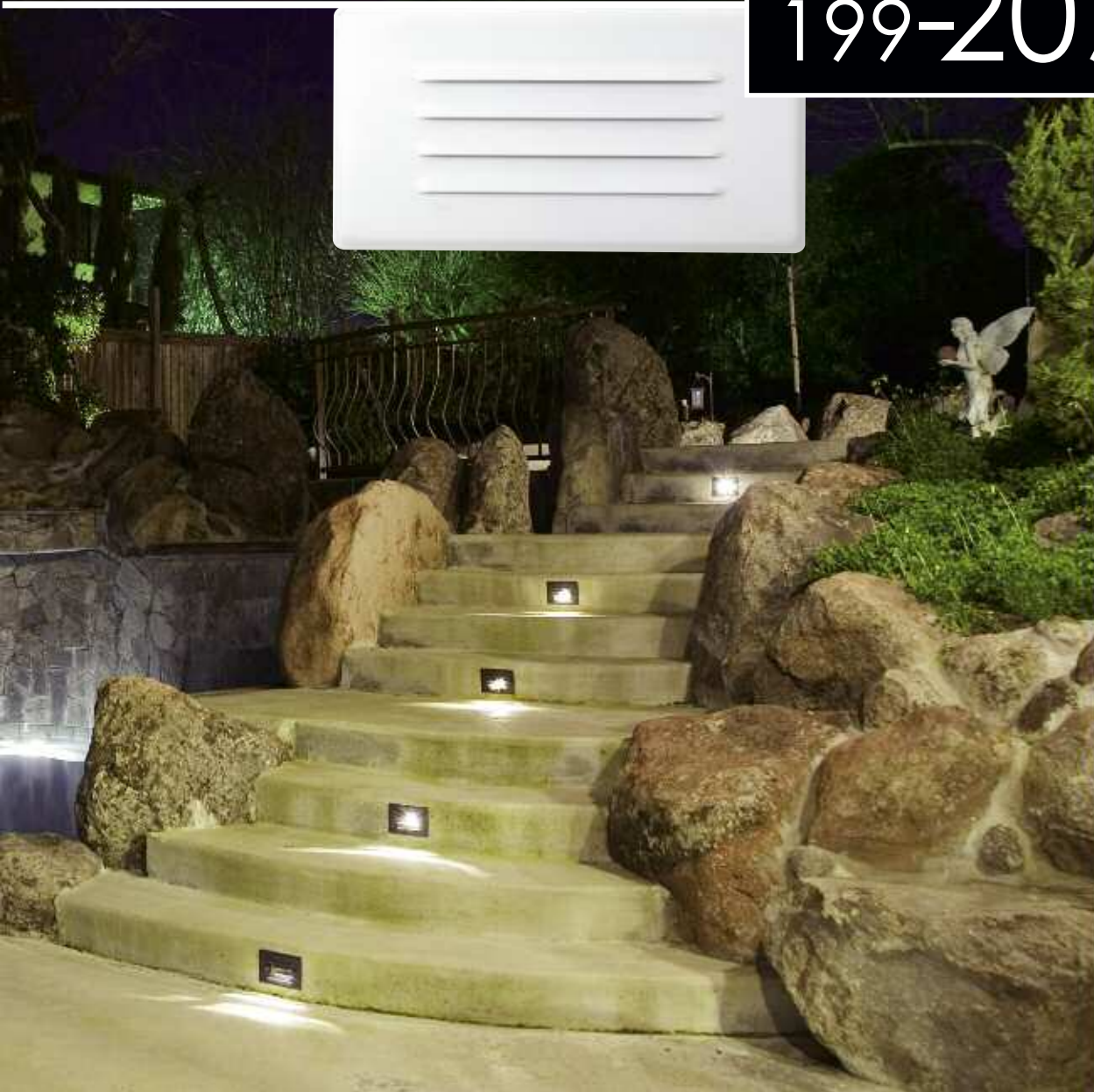

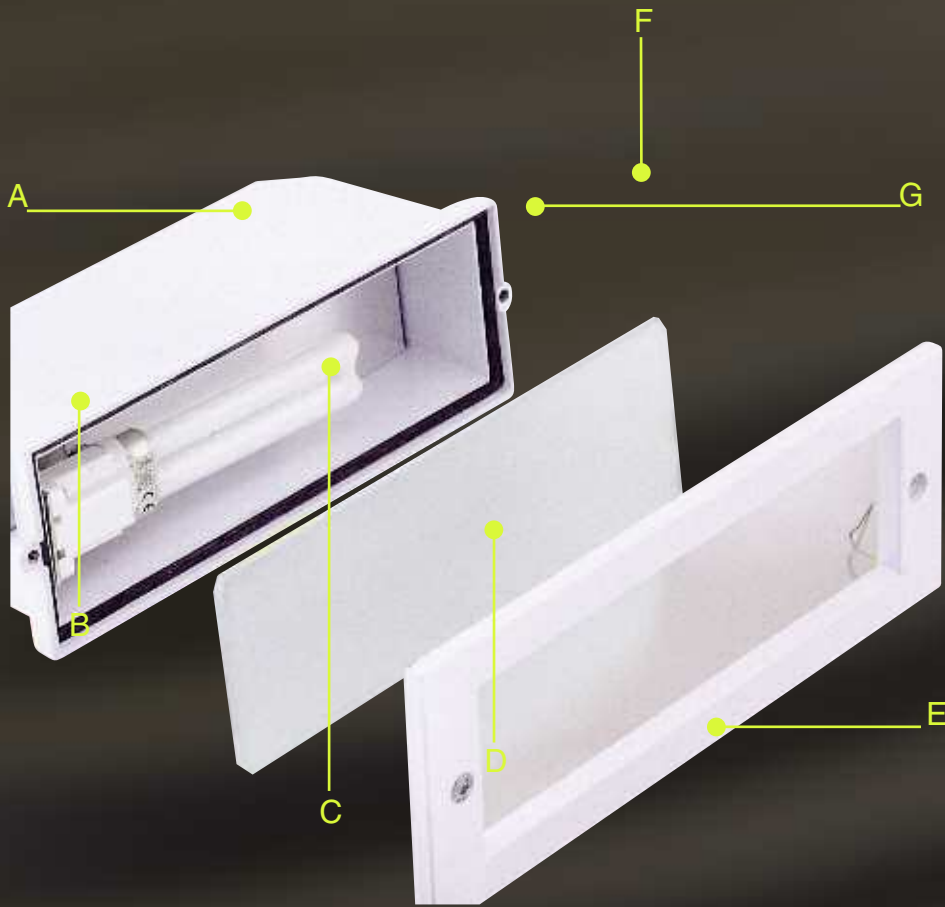

- A Diecast Housing
- B Pre-Punched Hole
- C PL Lamp
- D Frosted Lens
- E Diecast Frame
- F Gasket
- G Reflector

Diecast Bricklights



- A Diecast Housing
- B Pre-Punched Hole
- C PL Lamp
- D Frosted Lens
- E Diecast Frame
- F Gasket
- G Reflector

ELST 31W
ELST 31B

White finish (40W T10 Lamp)
Black finish (40W T10 Lamp)

- Compact Fluorescent Bricklight with angled louver.
- Diecast aluminum housing with diffused glass lens.
- U.L. listed for wet location.
- Black or White finish.

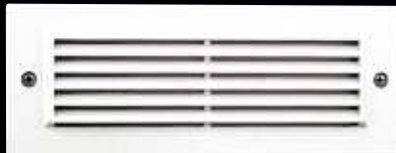

Faceplate Dimensions: 9 3/4"W x 3 5/8"H
Housing Dimensions: 8 1/2"W x 3 1/8"H x 4 1/8"D
Hole Cutout Dimensions: 8 3/4"W x 3 1/4"H

ELST 32W
ELST 32B

White Finish (40W T10 Lamp)
Black Finish (40W T10 Lamp)

- Incandescent Bricklight with open faceplate.
- Diecast aluminum housing with diffused glass lens.
- Suitable for wet location.
- U.L. listed for wet location.
- Black or White finish.



Faceplate Dimensions: 9 3/4"W x 3 5/8"H
Housing Dimensions: 8 1/2"W x 3 1/8"H x 4 1/8"D
Hole Cutout Dimensions: 8 3/4"W x 3 1/4"H

ELST 37W
ELST 37B

White Finish (40W T10 Lamp)
Black Finish (40W T10 Lamp)

- Incandescent Bricklight with grill faceplate.
- Diecast aluminum housing with diffused glass lens.
- Suitable for wet location.
- U.L. listed for wet location.
- Black or White finish.

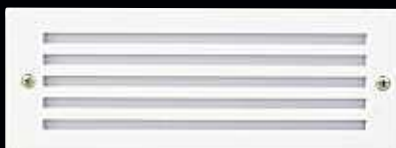

Faceplate Dimensions: 9 3/4"W x 3 5/8"H
Housing Dimensions: 8 1/2"W x 3 1/8"H x 4 1/8"D
Hole Cutout Dimensions: 8 3/4"W x 3 1/4"H

Diecast Bricklights (Cont.)

- ELST 33W, B (7W / 9W Twin Tube 2 Pin G23 Base)
 ELST 34W, B (13W Twin Tube 2 Pin GX23-2 Base)
 ELST 35W, B (18W Twin Tube 4 Pin G24Q-2 Base)
 ELST 36W, B (26W QUAD 4 Pin G24Q-3 Base)

- Compact Fluorescent Bricklight with open faceplates.
- Diecast aluminum housing with diffused glass lens.
- U.L. listed for wet location.
- Black or White finish.



Faceplate Dimensions: 9 3/4"W x 3 5/8"H
 Housing Dimensions: 8 1/2"W x 3 1/8"H x 4 1/8"D
 Hole Cutout Dimensions: 8 3/4"W x 3 1/4"H

- ELST 38W, B (7W / 9W Twin Tube 2 Pin G23 Base)
 ELST 39W, B (13W Twin Tube 2 Pin Gx23-2 Base)
 ELST 40W, B (18W Quad 4 Pin G24Q-2 Base)
 ELST 41W, B (26W Quad 4 Pin G24Q-3 Base)

- Compact Fluorescent Bricklight with grill faceplate.
- Diecast aluminum housing with diffused glass lens.
- U.L. listed for wet location.
- White finish is powder coated. Black finish is painted in factory.

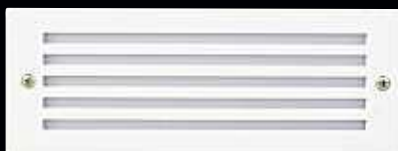

Faceplate Dimensions: 9 3/4"W x 3 5/8"H
 Housing Dimensions: 8 1/2"W x 3 1/8"H x 4 1/8"D
 Hole Cutout Dimensions: 8 3/4"W x 3 1/4"H

- ELST 44W, B (7W / 9W Twin Tube 2 Pin G23 Base)
 ELST 45W, B (13W Twin Tube 2 Pin Gx23-2 Base)
 ELST 46W, B (18W Quad 4 Pin G24Q-2 Base)
 ELST 47W, B (26W Quad 4 Pin G24Q-3 Base)

- Compact Fluorescent Bricklight with angled louver faceplate.
- Diecast aluminum housing with diffused glass lens.
- U.L. listed for wet location.
- White finish is powder coated. Black finish is painted in factory.

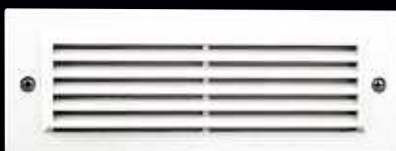

Faceplate Dimensions: 9 3/4"W x 3 5/8"H
 Housing Dimensions: 8 1/2"W x 3 1/8"H x 4 1/8"D
 Hole Cutout Dimensions: 8 3/4"W x 3 1/4"H

- ELST 53W, B** (7W / 9W Twin Tube 2 Pin G23 Base)
- ELST 54W, B** (13W Twin Tube 2 Pin Gx23-2 Base)
- ELST 55W, B** (18W Quad 4 Pin G24Q-2 Base)
- ELST 56W, B** (26W Quad 4 Pin G24Q-3 Base)

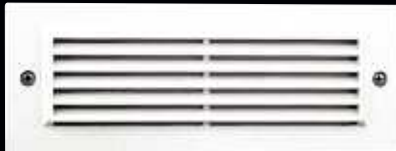

- Compact Fluorescent Bricklight with angled louvered faceplate.
- Diecast aluminum housing without lens.
- U.L. listed for wet location.
- White finish is powdered coated. Black finish is painted in factory.

Faceplate Dimensions: 9 3/4"W x 3 5/8"H
 Housing Dimensions: 8 1/2"W x 3 1/8"H x 4 1/8"D
 Hole Cutout Dimensions: 8 3/4"W x 3 1/4"H

Incandescent Steplights

- ELST 42B** (Type A or T10 40W Max Medium Base)
- ELST 42W** (Type A or T10 40W Max Medium Base)



- Incandescent steplight with louvered faceplate.
- Galvanized stamped steel housing, powder coated
- Thermal device included.
- U.L. listed for damp location.
- For indoor use.

Faceplate Dimensions: 9 1/2"W x 5"H
 Housing Dimensions: 8 3/8"W x 3 5/8"H x 3 1/2"D
 Hole Cutout Dimensions: 8 5/8"W x 3 7/8"H

- ELST 43B** (Type A or T10 40W Max Medium Base)
- ELST 43W** (Type A or T10 40W Max Medium Base)

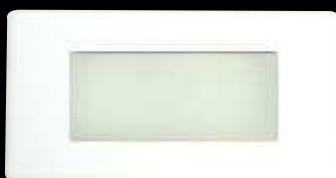

- Incandescent steplight with frosted glass lens.
- Galvanized stamped steel housing, powder coated
- Thermal device included.
- U.L. listed for damp location.
- For indoor use.

Faceplate Dimensions: 9 1/2"W x 5"H
 Housing Dimensions: 8 3/8"W x 3 5/8"H x 3 1/2"D
 Hole Cutout Dimensions: 8 5/8"W x 3 7/8"H

Compact Fluorescent Steplights

ELST 48B (13W double Twin Tube 2 Pin G23 Base)
ELST 48W (13W double Twin Tube 2 Pin G23 Base)



- Compact Fluorescent Steplight with frosted glass lens face plate
- Galvanized Stamped steel housing, powder coated.
- UL Listed

Faceplate Dimensions: 9 1/2"W x 5"H
 Housing Dimensions: 8 3/8"W x 3 5/8"H x 3 1/2"D
 Hole Cutout Dimensions: 8 5/8"W x 3 7/8"H

ELST 49B (7W/9W Twin Tube 2 Pin G23 Base)
ELST 49W (7W/9W Twin Tube 2 Pin G23 Base)



- Compact Fluorescent Steplight with louvered faceplate.
- Galvanized stamped steel housing, powder coated.
- Damp location listed
- U.L. listed

Faceplate Dimensions: 9 1/2"W x 5"H
 Housing Dimensions: 8 3/8"W x 3 5/8"H x 3 1/2"D
 Hole Cutout Dimensions: 8 5/8"W x 3 7/8"H

ELST 52B (13W double Twin Tube 2 Pin Gx23-2 Base)
ELST 52W (13W double Twin Tube 2 Pin Gx23-2 Base)



- Compact Fluorescent Steplight with louvered faceplate.
- Galvanized stamped steel housing, powder coated.
- Damp location listed
- U.L. listed

Faceplate Dimensions: 9 1/2"W x 5"H
 Housing Dimensions: 8 3/8"W x 3 5/8"H x 3 1/2"D
 Hole Cutout Dimensions: 8 5/8"W x 3 7/8"H

- ELST 20W** LED Lights (white Face plate)
- ELST 20B** LED Lights (black Face plate)
- ELST 20BZ** LED Lights (bronze Face plate)



- Energy Efficient LED Steplight. with frosted glass lens face plate
- Galvanized Stamped steel housing, powder coated.
- UL Listed for damp locations
- UL listed for direct contact with installation (IC Housing)
- Use for indoor and outdoor
- 120V, 60Hz

Faceplate Dimensions: 9 1/2"W x 5"H
 Housing Dimensions: 8 3/8"W x 3 5/8"H x 3 1/2"D
 Hole Cutout Dimensions: 8 5/8"W x 3 7/8"H

- ELST 21W** LED Lights (white Face plate)
- ELST 21B** LED Lights (black Face plate)
- ELST 21BZ** LED Lights (bronze Face plate)



- Energy Efficient LED Steplight. with louvered faceplate.
- Galvanized Stamped steel housing, powder coated.
- UL Listed for damp locations
- UL listed for direct contact with installation (IC Housing)
- Use for indoor and outdoor
- 120V, 60Hz

Faceplate Dimensions: 9 1/2"W x 5"H
 Housing Dimensions: 8 3/8"W x 3 5/8"H x 3 1/2"D
 Hole Cutout Dimensions: 8 5/8"W x 3 7/8"H

- ELST 22W** LED Lights (white Face plate)
- ELST 22B** LED Lights (black Face plate)
- ELST 22BZ** LED Lights (bronze Face plate)



- Energy Efficient LED Steplight. with frosted glass lens face plate
- Galvanized Stamped steel housing, powder coated.
- UL Listed for damp locations
- UL listed for direct contact with installation (IC Housing)
- UL listed for through wiring with Junction Box
- Use for indoor and outdoor
- 120V, 60Hz

Faceplate Dimensions: 9 1/2"W x 5 3/4"H
 Housing Dimensions: 12 1/4"W x 6 1/2"H x 3 1/2"D

- ELST 23W** LED Lights (white Face plate)
- ELST 23B** LED Lights (black Face plate)
- ELST 23BZ** LED Lights (bronze Face plate)



- Energy Efficient LED Steplight. with louvered faceplate.
- Galvanized Stamped steel housing, powder coated.
- UL Listed for damp locations
- UL listed for direct contact with installation (IC Housing)
- UL listed for through wiring with Junction Box
- Use for indoor and outdoor
- 120V, 60Hz

Faceplate Dimensions: 9 1/2"W x 5 3/4"H
 Housing Dimensions: 12 1/4"W x 6 1/2"H x 3 1/2"D

Step Light Face Plates

ELST 10B
ELST 10W

Black Finish, replacement faceplate
White Finish ELST42, ELST49, ELST52



Faceplate Dimensions: 9 1/2"W x 5"H

PST4W
PST4B

Faceplate only for
ELST44, 45, 46, 47, 31, 53, 54, 55, 56



Faceplate Dimensions: 9 3/4"W x 3 5/8"H

ELST 11B

Black Finish, replacement faceplate and lens

ELST 11W

White Finish ELST43, ELST48

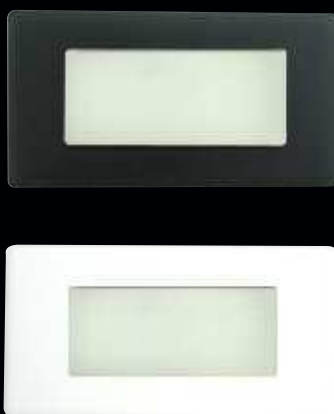

Faceplate Dimensions: 9 1/2"W x 5"H

PST1W **NEW!**
PST1B

Faceplate only for
ELST38, 39, 40, 41, 37



Faceplate Dimensions: 9 3/4"W x 3 5/8"H

PST5W
PST5B

Faceplate only for
ELST32, 33, 34, 35, 36



Faceplate Dimensions: 9 3/4"W x 3 5/8"H

PST2L **NEW!**

Replacement lens for
all diecast steplights



NEW! Incandescent and LED Mini-Step Lights
Installs on a single gang receptacle box

ELST61W
ELST61B
ELST61N
ELST61BZ

NEW!



Incandescent Mini Step Light, 120V,
7W lamp, vertical mount louvered
Faceplate Dimensions: 2 3/4" x 4 1/2"

ELST71W
ELST71B
ELST71N
ELST71BZ

NEW!



Incandescent Mini Step Light, 12V,
7W lamp, vertical mount louvered
Faceplate Dimensions: 2 3/4" x 4 1/2"

ELST62W
ELST62B
ELST62N
ELST62BZ

NEW!



Incandescent Mini Step Light, 120V,
7W lamp, horizontal mount louvered
Faceplate Dimensions: 4 1/2" x 2 3/4"

ELST72W
ELST72B
ELST72N
ELST72BZ

NEW!



Incandescent Mini Step Light, 12V,
7W lamp, horizontal mount louvered
Faceplate Dimensions: 4 1/2" x 2 3/4"

ELST63B
ELST63N
ELST63W
ELST63BZ

NEW!



Incandescent Mini Step Light, 120V,
7W lamp, with smooth white acrylic
lens, vertical or horizontal mount
Faceplate Dimensions: 4 1/2" x 2 3/4"

ELST73B
ELST73N
ELST73W
ELST73BZ

NEW!



Incandescent Mini Step Light, 12V,
7W lamp, with smooth white acrylic
lens, vertical or horizontal mount
Faceplate Dimensions: 4 1/2" x 2 3/4"

ELST64W
ELST64B
ELST64N
ELST64BZ

NEW!



LED Mini Step Light, 120V, 10 white LED
lamps, vertical mount louvered
Faceplate Dimensions: 2 3/4" x 4 1/2"

ELST74W
ELST74B
ELST74N
ELST74BZ

NEW!



LED Mini Step Light, 12V AC, 10 white
lamps, vertical mount louvered
Faceplate Dimensions: 2 3/4" x 4 1/2"

ELST65W
ELST65B
ELST65N
ELST65BZ

NEW!



LED Mini Step Light, 120V, 10 white LED
lamps, horizontal mount louvered
Faceplate Dimensions: 4 1/2" x 2 3/4"

ELST75W
ELST75B
ELST75N
ELST75BZ

NEW!



LED Mini Step Light, 12V AC, 10 white
lamps, horizontal mount louvered
Faceplate Dimensions: 4 1/2" x 2 3/4"

ELST66B
ELST66N
ELST66W
ELST66BZ

NEW!



LED Mini Step Light, 120V, 10 white LED
lamps, with smooth white acrylic lens,
vertical or horizontal mount
Faceplate Dimensions: 4 1/2" x 2 3/4"

ELST76B
ELST76N
ELST76W
ELST76BZ

NEW!



LED Mini Step Light, 12V AC, 10 white
lamps, with smooth white acrylic lens,
vertical or horizontal mount
Faceplate Dimensions: 4 1/2" x 2 3/4"

Outdoor Lighting

- WALL PACKS
- FLOOD LIGHTS

Whether you need diecast aluminum or standard housings, compact fluorescent H.I.D. wall packs (metal halide or high pressure sodium). Elco Lighting has the fixture for you. U.L. listed for wet locations. Elco's outdoor lighting products are perfect for applications such as parking areas, perimeter lighting, entrance and walkways, waterfront, loading, platforms, recreational areas and more.

208-213

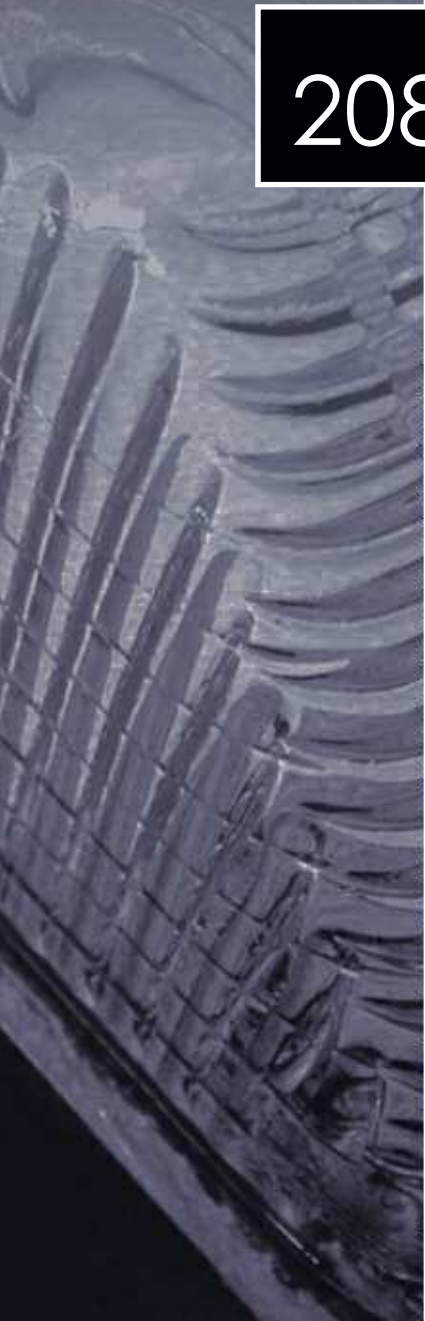

Construction, Applications

- Features die cast aluminum housing, diffuser glass, moisture and dust proof, anodized aluminum reflector, Architectural bronze finish.
- Two piece heavy duty die cast aluminum housing. Face frame is hinged and secured to back box with two stainless steel screws.
- A Silicone gasket provides a weather seal.
- 1/2" tapped holes for securing conduit & installing photo cell.
- High impact, heat resistant, borosilicate glass diffuser for wide spread distribution.
- One piece stippled asymmetric anodized aluminum reflector designed in conjunction with the diffuser for efficiency.
- U.L. listed for wet location.

Mouting

- Wall mount directly over standard 4" outlet box or with surface conduit for indoor or outdoor applications.

Application

- Parking areas, perimeter lighting, entrance & walkways, waterfronts, loading platforms, recreational areas.

High Pressure Sodium

Mini high pressure sodium wallpack. Medium base socket. 120V N.P.F. ballast. USA made H.I.D. lamp included. U.L. listed.

- EPS 35 (lamp: 35W / ED17 / Medium Base)
- EPS 50 (lamp: 50W / ED17 / Medium Base)
- EPS 70 (lamp: 70W / ED17 / Medium Base)
- EPS 100 (lamp: 100W / ED17 / Medium Base)

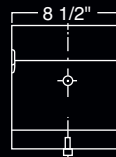
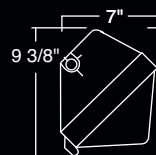

Medium size high pressure sodium wallpack. Medium base socket. 120V N.P.F. ballast. USA made H.I.D. lamp included. U.L. listed.

- EPS 150 (lamp: 150W / ED17 / Medium Base)

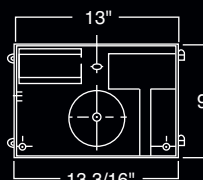
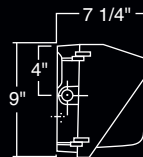

Large size high pressure sodium wallpack. Mogul base socket. Multitap (120/208/240/277V) H.P.F. ballast. Lamp included. U.L. listed.

- EPS 250 (lamp: 250W / Mogul Base)
- EPS 400 (lamp: 400W / Mogul Base)

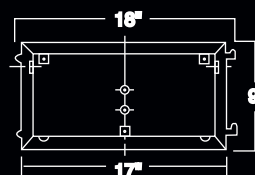
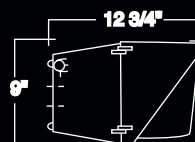

H.I.D. Wall Packs

- These fixtures utilize the energy efficient, long life metal halide lamps.
- Two piece heavy duty die cast aluminum housing. Face frame is hinged and secured to back box with two stainless steel screws.
- A Silicone gasket provides a weather seal.
- 1/2" tapped holes for securing conduit & installing photo cell.
- High impact, heat resistant, borosilicate glass diffuser for wide spread distribution.
- One piece stippled asymmetric anodized aluminum reflector designed in conjunction with the diffuser for efficiency.
- U.L. listed for wet location.

Mouting

- Wall mount directly over standard 4" outlet box or with surface conduit for indoor or outdoor applications.

Application

- Parking areas, perimeter lighting, entrance & walkways, waterfronts, loading platforms, recreational areas.

Metal Halide

Medium Metal Halide wallpack. Medium base lamp. Multitap (120/208/240/277V) ballast. USA made
H.I.D. lamp included. U.L. listed.

- EMH 70 (Lamp: 70W / ED17 / Medium Base)
- EMH 100 (Lamp: 100W / ED17 / Medium Base)
- EMH 175 (Lamp: 175W / ED17 / Medium Base)

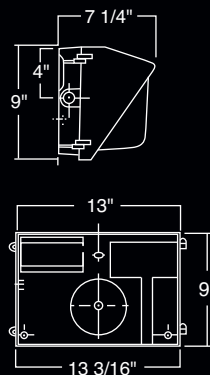

Large metal halide wallpack. Mogul base lamp. Multitap (120/208/240/277V) H.P.F. ballast. Lamp included. U.L. listed.

- EMH 250 (Lamp: 70W / ED28 / Mogul Base)
- EMH 400 (Lamp: 70W / ED28 / Mogul Base)

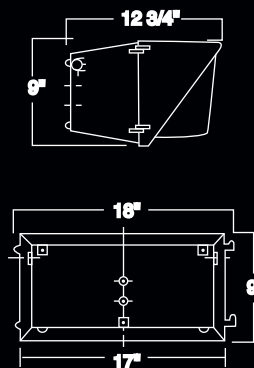

- These fixtures utilize the energy efficient, long life metal halide lamps.
- Two piece heavy duty die cast aluminum housing. Face frame is hinged and secured to back box with two stainless steel screws.
- A Silicone gasket provides a weather seal.
- 1/2" tapped holes for securing conduit or photocell. High impact, heat resistant, borosilicate glass lens.
- U.L. listed for wet location.

Metal Halide

Medium Metal Halide flood light. Medium base lamp
Multitap (120/208/240/277V) H.P.F. ballast. USA made
H.I.D. lamp included. U.L. listed.

EMH 100L (Lamp: 100W Medium Base ED28)
EMH 175L (Lamp: 175W Medium Base ED28)

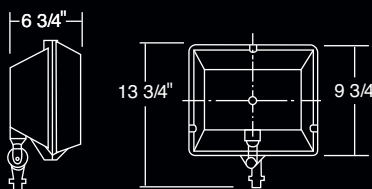

Large Metal Halide flood light. Mogul base lamp
Multitap (120/208/240/277V) H.P.F. ballast. USA made
H.I.D. lamp included. U.L. listed.

EMH250L (Lamp: 250W Mogul Base ED28)
EMH400L (Lamp: 400W Mogul Base ED28)

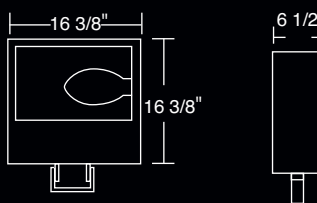

Elco Lightings

OUTDOOR CATALOG

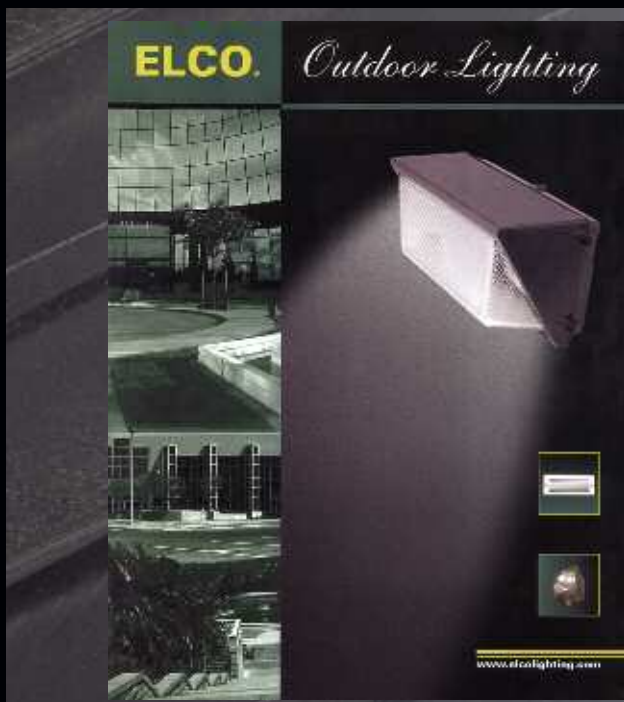

This catalog contains important information about:

- Diecast Brick Lights
- Diecast Step Lights
- H.I.D. High Pressure Sodium Wall Packs
- H.I.D. Metal Halide Wall Packs
- H.I.D. High Pressure Sodium Flood Lights
- H.I.D. Metal Halide Floods
- Compact Fluorescent Flood Lights

To order our "Architectural Catalog" please contact us at Elco Headquarters.

H.I.D. Flood Lights

- Features Die Cast aluminum housing, glass diffuser, moisture and dust proof, anodized aluminum reflector, threaded apertures for conduit & photo cell, architectural bronze finish.
- Two piece heavy duty die cast aluminum housing. Face frame is hinged and secured to back box with two stainless steel screws.
- A Silicone gasket provides a weather seal.
- One piece high impact tempered glass diffuse lens.
- One piece anodized aluminum reflector provides wide beam distribution.
- U.L. listed for wet location.

Mounting

- Wall or pole mount with post top fitter. For indoor or outdoor applications.

Application

- Parking areas, perimeter lighting, entrance & walkways, waterfronts, loading platforms, recreational areas.

High Pressure Sodium

Small size high pressure sodium flood light. Medium base lamp.
120 Volts N.P.F. Ballast. USA made H.P.S. lamp included.
U.L. listed.

- | | |
|----------|-----------------------------------|
| EPS 35S | (Lamp: 35W / ED17 / Medium Base) |
| EPS 50S | (Lamp: 50W / ED17 / Medium Base) |
| EPS 70S | (Lamp: 70W / ED17 / Medium Base) |
| EPS 100S | (Lamp: 100W / ED17 / Medium Base) |
| EPS 150S | (Lamp: 150W / ED17 / Medium Base) |

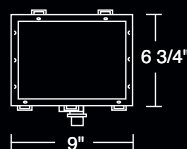
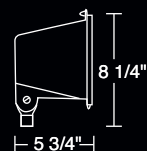

Medium size high pressure sodium flood light.
Medium base lamp. 120 Volts N.P.F. Ballast.
USA made H.P.S. lamp included. U.L. listed.

- | | |
|----------|-----------------------------------|
| EPS 35M | (Lamp: 35W / ED17 / Medium Base) |
| EPS 50M | (Lamp: 50W / ED17 / Medium Base) |
| EPS 70M | (Lamp: 70W / ED17 / Medium Base) |
| EPS 100M | (Lamp: 100W / ED17 / Medium Base) |
| EPS 150M | (Lamp: 150W / ED17 / Medium Base) |

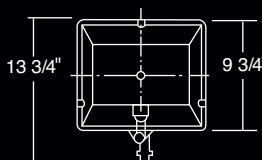

Large size high pressure sodium flood light. Mogul base lamp.
Multitap (120/208/240/277V) H.P.F. ballast. Lamp included.
U.L. listed.

- | | |
|----------|----------------------------------|
| EPS 250L | (Lamp: 250W / ED28 / Mogul Base) |
| EPS 400L | (Lamp: 400W / ED28 / Mogul Base) |

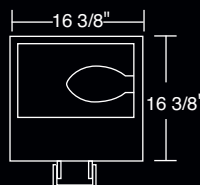

Compact Fluorescent Floodlights

- This energy efficient floodlight save 80% in electricity costs using PL-13 watt lamp, and can easily replace existing incandescent wall fixtures.
- Space age lexan housing is more durable than metal and is rust proof and shockproof.
- Easy to install. Comes completely assembled.
- U.L. listed for wet locations. Lamps (1)13W, (2)13W and (3)13W
- Lamps included.

Mounting

- Mounting vertical, or horizontal. Indoor or outdoor applications
- 1/2" pipe thread for weatherproof box, or canopy mounting.

Application

- Application security, landscape, walkways, entrance, recreational areas, signs, perimeter, parking areas.

(1) 13Watt

ES 1303 (1-13W PL Lamp)

One 13W lamp Flood Light
U.L. listed for wet location.



(2) 13Watt

ES 2603 (2-13W PL Lamp)

Two 13W lamp Flood Light U.L.
listed for wet location.



(3) 13Watt

WS40 (3-13W PL Lamp)

Three 13W lamp Flood Light
U.L. listed for wet location.



Exit & Emergency

Elco Lighting's high quality, affordable Exit and Emergency fixtures provide a variety of different styles and benefits designed to meet the requirements of any application. Dual voltage options(120 and 277 VAC), brown-out activation (unit automatically switches to emergency mode if supply voltage drops below 80%), automatic low voltage disconnect, thermal protection, short circuit protection and reverse polarity protection are just a few of the important standardized features of these products. Available in long-life, energy-saving LEDs, self-powered, battery back-up, incandescent, self-illuminating, and emergency light/exit combos. Elco's line of emergency fluorescent downlights are available with 6", 7" and 8" apertures and come with a variety of attractive reflector and baffle trims.

214-237



EE21RW Red letters
EE22GW Green letters

Weatherproof LED Exit Sign. 120/277 VAC. No maintenance. Enclosure resistant to corrosive atmospheres, not-hazardous dust environments, water spray or splashing water. ETL Listed.

- Wet location listed
- Battery back-up with test switch



120/277V Diecast LED Exit Light with batteries. ABS, corrosion resistant UV Stabilized enclosure. Available in red and green letters.

EE71RD Red letters
EE72GD Green letters

EE73RD Red letters
EE74GD Green letters

Double Face Diecast LED Exit Light with batteries. 120/277V. ABS, corrosion resistant UV Stabilized enclosure.



LED Exit Signs

- Contemporary style LED exit signs
- Completely concealed arrow & mounting knockouts are easily removable.
- 120/277V Volt dual input.
- Study ABS plastic housing.
- Sealed Nickel Cadmium Battery

EELED 120/277V green LED with battery backup, ENERGY STAR qualified
EELE1 120/277V red LED with battery backup, ENERGY STAR qualified

EELEDB 120/277V green LED with battery backup, black housing
EELE1B 120/277V red LED with battery backup, black housing

EELE2 120/277V green LED 2 circuit
EELE3 120/277V red LED 2 circuit

EELE5 120/277V green LED without battery backup
EELE6 120/277V red LED without battery backup

- Single or double face, 6" letters.
- Off-white color.
- Side, top or back mounting
- U.L. listed.



Emergency Lights and Exit Signs

- Supplied with extra faceplate for double face applications
- Injection molded flame retardant, high impact thermoplastic housing and faceplate.
- Knockouts for directional chevrons standard.
- 6V maintenance free lead calcium battery.
- Dual voltage (120/277)
- Automatic low voltage disconnect.
- Solid state charger.
- Universal mounting canopy for top installation.

EE84HG 120/277V LED exit sign with battery backup, green letters and halogen MR16 emergency lights

EE83HR 120/277V LED exit sign with battery backup, red letters and halogen MR16 emergency lights

- Two adjustable halogen MR16 lighting heads
- LED lamp life of 25 years.
- Includes downlight.
- U.L. listed.



Emergency Lights and Exit Signs

- EE81S** Red letters
- EE80S** Green letters

Self illuminating Exit Sign. Does not require any electricity to operate. Provide constant and uniform illumination. Available in red and green letters.



- EE87HR** Red letters
- EE88HG** Green letters

Exit Sign with Two Adjustable 5.6W Emergency Light Heads
Sealed Maintenance Free Battery Backup
Available in red and green letters. U.L. listed or E.T.L listed.



MR 16-6V



MR16 halogen lamp 5W 6V

LED Exit Sign & Emergency

- Supplied with extra faceplates for doubleface applications.
- Injection molded flame retardant, high impact thermoplastic housing and faceplate.
- Knockouts for directional chevrons standard.
- 6V maintenance free lead calcium battery.
- Dual voltage (120/277)
- Automatic low voltage disconnect.
- Solid state charger.
- Universal mounting canopy for top installation.
- Two adjustable 5.6 Watt lighting heads
- LED lamp life of 25 years.
- U.L. listed.

EE97HR 120/277V red LED exit with emergency
EE98HG 120/277V green LED exit with emergency

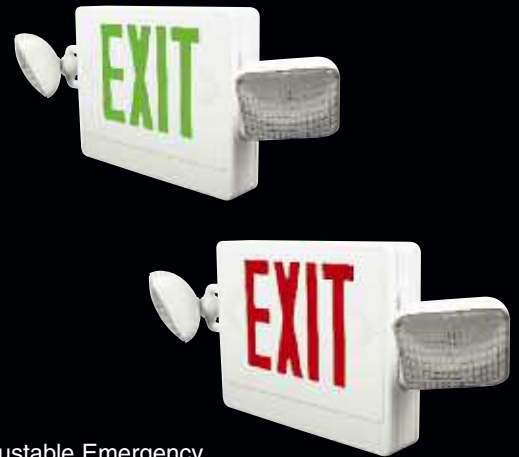

Adjustable Emergency Light Heads

LED Edge Lite Exit Sign

- EDGLIT1G** LED edge light exit sign single face, green letters
120/277V with battery backup, ENERGY STAR qualified
- EDGLIT2G** LED edge light exit sign double face, green letters
120/277V with battery backup, ENERGY STAR qualified
- EDGLIT1R** LED edge light exit sign single face, red letters
120/277V with battery backup, ENERGY STAR qualified
- EDGLIT2R** LED edge light exit sign double face, red letters
120/277V with battery backup, ENERGY STAR qualified



Transparent Exit Sign

NEW! Recessed LED Edge Lite Exit Sign

- EDGREC1R** LED edge light exit sign single face, red letters
120/277V with battery backup, with hanger bars
ENERGY STAR qualified
- EDGREC2R** LED edge light exit sign double face, red letters
120/277V with battery backup, with hanger bars
ENERGY STAR qualified
- EDGREC1G** LED edge light exit sign single face, green letters
120/277V with battery backup, with hanger bars
ENERGY STAR qualified
- EDGREC2G** LED edge light exit sign double face, green letters
120/277V with battery backup, with hanger bars
ENERGY STAR qualified



Transparent Exit Sign

Emergency Lights

EE 20L

EE 20LB Black Housing

- 6" volt, maintenance free battery
- Dual voltage (120/277)
- Automatic low voltage disconnect
- Injection molded high impact thermoplastic housing
- Universal mounting plate with quick connect for labor saving installation

- Test Switch
- Solid state charger
- Two adjustable 5.6 watt lighting heads
- U.L. or E.T.L. listed



EERH15
Remote Head
6V, 5.4W

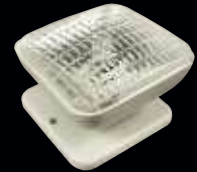

EE 40L

- Regulated charge voltage
- Reverse polarity protection
- Filtered charger output
- Universal mounting plate for ultimate flexibility
- Short circuit protection
- AC lockout

- 6" volt, maintenance free battery
- Dual voltage (120/277)
- Automatic low voltage disconnect
- Injection molded high impact thermoplastic
- Standard white housing
- U.L. or E.T.L. listed



EE 50L

- Regulated charge voltage
- Reverse polarity protection
- Filtered charger output
- Universal mounting plate for ultimate flexibility
- Short circuit protection
- Brownout protection
- AC lockout

- 6" volt, maintenance free battery
- Dual voltage (120/277)
- Automatic low voltage disconnect
- Injection molded high impact thermoplastic
- Standard white housing
- U.L. or E.T.L. listed



EE 70L

- 6" volt, maintenance free battery
- Dual voltage (120/277)
- Automatic low voltage disconnect
- Injection molded high impact thermoplastic
- Labor saving snap together housing
- Standard white housing

- Regulated charge voltage
- Reverse polarity protection
- Filtered charger output
- Universal mounting plate for ultimate flexibility
- Short circuit protection
- U.L. or E.T.L. listed



EEP3A

Sealed maintenance free 4.8V AA Nickel Cadmium battery for EELED and EELE1. 700 milli amps hour. 2 3/4" x 1 7/8" x 4"

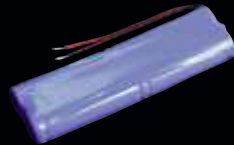

EEP8A

Sealed maintenance free 6V rechargeable battery backup for new EE2HX and EE2HR. 8 amps hour. 3 7/8"W x 2 1/4"D x 4 5/8"L



EEP4A

Sealed maintenance free 6V rechargeable battery backup for EE20L, EE40L, EE50L, EE70L, EE83HR, EE83HG, EE97HR, and EE98HG. 4 amps hour. 2 3/4" x 1 7/8" x 4"



L15

10W 140V candelabra base lamp for EE30X, EE31SX, EE60X, EE61X, EE2HR, and EE2HX.



L4

5W 6V wedge based lamp for EE60X, EE61X, EE20L, EE40L, EE50L and EE70L.



Exit Sign and Emergency Light Accessories

EEPS66

Polycarbonate Vandal/Environmental Shield Guard



EERT5R

Red LED

EERT6G

Green LED

Screw In LED Retrofit Kit for 120V with 3 socket types



EEWG11

Wire Guard 13.5"H x 15"W x 6"D

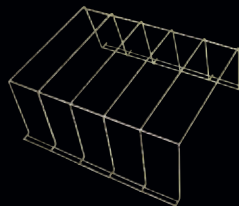

EERT5R-H

Red LED

EERT6G-H

Green LED

Hardwire LED retrofit kit for exit fixtures

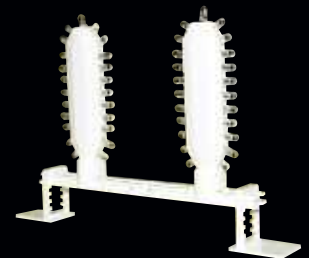

EEWG22

Wire Guard 13.5"H x 30"W x 6"D

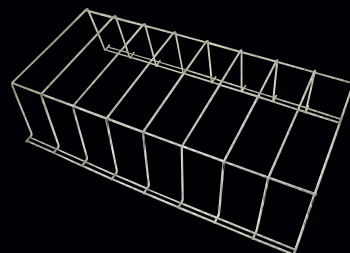

Heavy Duty Emergency Battery Units

KEM-50W

- 50W Emergency Unit for use with Emergency low voltage housings.
- 120/277V Dual Voltage operation
- Lead-Calcium Battery (12V 12Ah) delivers more than 90 minutes capacity to emergency lamps.
- Test switch and charge rate indicator.
- Low voltage battery disconnection- preventing deep discharge damage to the battery.
- Injection-molded thermoplastic ABS housing.
- Suitable for Damp Locations.
- Option of two fully adjustable glare-free round shape light heads (7.2W each)

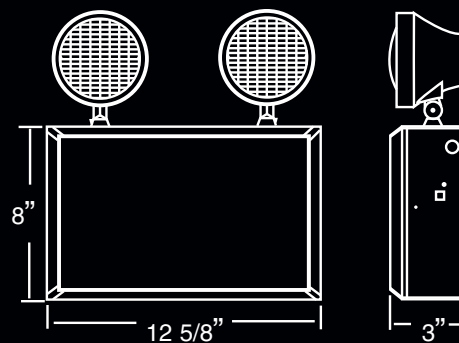

Dimensions: 12 5/8W x 8"H x 3"D

KEM-100W

- 100W Emergency Unit for use with Emergency low voltage housings.
- 120/277V Dual Voltage operation
- Lead-Calcium Battery (2 of 12V 12Ah) delivers more than 90 minutes capacity to emergency lamps.
- Test switch and charge rate indicator.
- Low voltage battery disconnection- preventing deep discharge damage to the battery.
- Injection-molded thermoplastic ABS housing.
- Suitable for Damp Locations.
- Option of two fully adjustable glare-free round shape light heads (7.2W each)

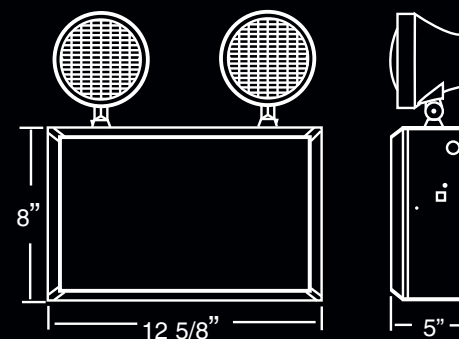

Dimensions: 12 5/8W x 8"H x 5"D

KEM-200W

- 200W Emergency Unit for use with Emergency low voltage housings.
- 120/277V Dual Voltage operation
- Lead-Calcium Battery (2 of 12V 18Ah) delivers more than 90 minutes capacity to emergency lamps.
- Test switch and charge rate indicator.
- Low voltage battery disconnection- preventing deep discharge damage to the battery.
- Injection-molded thermoplastic ABS housing.
- Suitable for Damp Locations.
- Option of two fully adjustable glare-free round shape light heads (7.2W each)

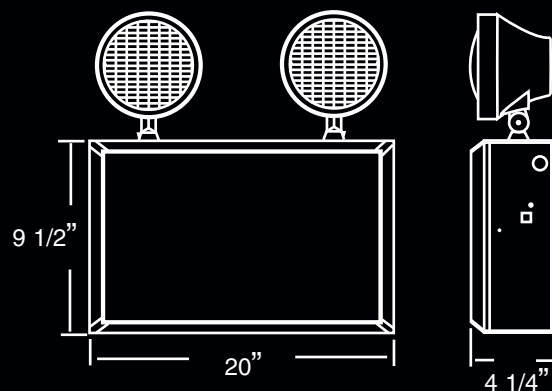

Dimensions: 20"W x 9 1/2"H x 4 1/4"D

<EXIT>



8" Architectural Compact Fluorescent Emergency Downlight

Attractive, dependable and maintenance-free, the Emergency advantage series is ideal for contemporary lighting applications. High temperature nickel cadmium batteries and solid-state electronics ensure a long, dependable service life. The Emergency advantage series matches standard fluorescent advantage downlights in appearance and automatically provides 90 minutes of emergency operation for 9W, 13W, 18W or 26W compact fluorescent lamps upon total or isolated power failure.

- Efficient, long-life 9W, 13W, 18W or 26W compact fluorescent (lamp not included).
- 650 Lumen light output in emergency mode from single compact fluorescent lamp
- Emergency frame-in module includes electronics and battery pack
- Installs in night light or switchable circuits
- High-performance trims available
- Hanger Bar not included
- Energy Efficient
- U.L. listed

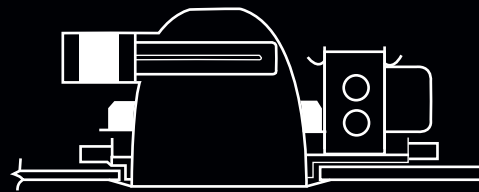

Height: 6 5/8" - Ceiling Opening: 8"
Frame Size: 13 1/4" x 15 3/4" - Trim O.D.: 9"

- ELH 8213EM** (2) 13W 2 Pin 120V PL/Quad Lamp N.P.F. Magnetic Ballast
- ELH 8218EM** (2) 18W 2 Pin 120V PL/Quad Lamp N.P.F. Magnetic Ballast
- ELH 8226EM** (2) 26W 2 Pin 120V PL/Quad Lamp N.P.F. Magnetic Ballast
- ELH 8126E-EM** (1) 26W 120/277V Electronic Ballast 4 Pin Triple Lamp
- ELH 8226E-EM** (2) 26W 4 Pin 120/277V PL/Quad Lamp Electronic Ballast

- ELH 8132E-EM** (1) 32W 120/277V 4Pin PL-T/32 H.P.F. Electronic Ballast
- ELH 8142E-EM** (1) 42W 120/277V 4Pin PL-T/42 H.P.F. Electronic Ballast

- ELH 126E-EM** (2) 26W 120/277 4Pin Lamp Electronic Ballast
- ELH 132E-EM** (2) 32W 120/277 4Pin Lamp Electronic Ballast
- ELH 142E-EM** (2) 42W 120/277 4Pin Lamp Electronic Ballast

EL 821G
EL 821C
Reflector Trim
O.D.: 9"



EL 826C
EL 826G
Reflector with
Suspended
Glass lens
O.D.: 9"



EL 830B
EL 830W
Reflector with
Baffle Trim
O.D.: 9"



EL 842W
EL 842B
Regressed Lens
with Baffle
O.D.: 9"



EL 862G
EL 862C
Regressed Lens
with Reflector
O.D.: 9"



EL 888G
EL 888C
Cross Baffle
Reflector Trim
O.D.: 9"

NEW!



Compact Fluorescent Lamp Data

Lamp Wt. Type	Initial Lumens	Efficiency (LPW)	Life	CRI
9W Twin	600	67	10,000	82
13W Twin	900	69	10,000	82
13W Quad	860	67	10,000	82
18W Quad	1250	69	10,000	86
26W Quad	1800	69	10,000	86

Compact Fluorescent Lamp Data

Fluorescent		Incandescent	
Wattage	Lumens	Wattage	Lumens
2-9W Twin	1200	1-75W	1190
2-13W Twin	1800	1-100W	1750
2-13W Quad	1720	1-100W	1750
2-18W Quad	2500	1-150W	2850
2-26W Quad	3600	1-200W	4010

Standard Fixture

High Power Fixture

# of Lamps Wt. Type	Voltage	Power Factor	Total Watts	Oper. Amps	Power Factor	Total Watts	Oper. Amps
2-9W	120V	0.57	24	0.36	0.91	24	0.22
2-9W	277V	0.31	26	0.36	0.90	26	0.10
2-13W	120V	0.47	34	0.60	0.91	34	0.32
2-13W	277V	0.23	39	0.60	0.90	39	0.16
2-18W	120V	0.38	48	1.06	0.95	48	0.42
2-18W	277V	0.96	44	0.17	STD	STD	STD
2-26W	120V	0.41	64	1.30	0.95	64	0.56
2-26W	277V	0.94	60	0.23	STD	STD	STD

8" Architectural Compact Fluorescent Emergency Downlight

Attractive, dependable and maintenance-free, the Emergency advantage series is ideal for contemporary lighting applications. High temperature nickel cadmium batteries and solid-state electronics ensure a long, dependable service life. The Emergency advantage series matches standard fluorescent advantage downlights in appearance and automatically provides 90 minutes of emergency operation for 9W, 13W, 18W or 26W compact fluorescent lamps upon total or isolated power failure.

- Efficient, long-life 32W or 42W compact fluorescent lamp not included.
- 650 Lumen light output in emergency mode from single compact fluorescent lamp
- Emergency frame-in module includes electronics and battery pack
- Installs in night light or switchable circuits
- High-performance trims available
- Hanger Bar not included
- Energy Efficient
- U.L. listed

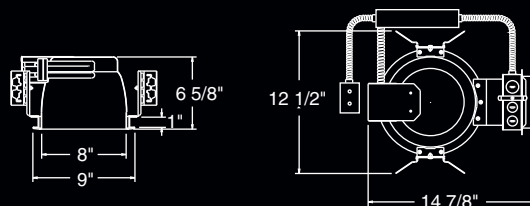

ELH 8232E-EM (2) 32W 120/277V 4Pin PL-T/32 H.P.F. Electronic Ballast
ELH 8242E-EM (2) 42W 120/277V 4Pin PL-T/42 H.P.F. Electronic Ballast

Height: 6 5/8" - Ceiling Opening: 8"
 Frame Size: 13 1/4" x 15 3/4" - Trim O.D.: 9"

EL 827C
EL 827G
 Reflector with
 Suspended
 Glass lens
 O.D.: 9"



EL 831B
EL 831W
 Baffle Trim
 with Reflector
 O.D.: 9"



EL 841G
EL 841C
EL 841W
 Reflector Trim
 O.D.: 9"



EL 843W
EL 843B
 Regressed Lens
 with Baffle
 O.D.: 9"



EL 882G
EL 882C
 Regressed Lens
 with Reflector
 O.D.: 9"



EL 889C
EL 889G
 Cross Baffle
 Reflector Trim
 O.D.: 9"



8" Compact Fluorescent Emergency IC Downlight with Plaster Frame

Compact fluorescent emergency IC housing with plaster frame. For (2) horizontally mounted lamps with integral fluorescent electronic ballast. Damp location listed Feed through listed 7 1/4" height allows use in 2 x 8 construction Trim support adjusts 3/4" to accommodate different ceiling thicknesses. 24" captive hanger bars included. For direct contact with insulation.

- Efficient, long-life compact fluorescent lamp not included.
- 650 Lumen light output in emergency mode from single compact fluorescent lamp
- Emergency frame-in module includes electronics and battery pack
- Installs in night light or switchable circuits
- High-performance trims available
- Hanger Bar not included
- Energy Efficient
- U.L. listed

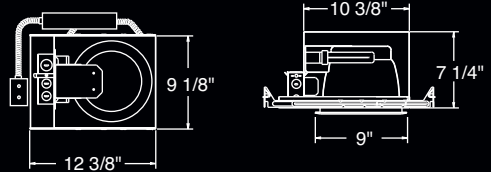

Height: 7 1/4" - Ceiling Opening: 8"
Trim O.D.: 9"

ELH 218ICE-EM (2) 18W Quad 4 Pin 120/277 Electronic Ballast

ELH 226ICE-EM (2) 26W Quad 4 Pin 120/277 Electronic Ballast

EL 821G

EL 821C

Reflector Trim
O.D.: 9"



EL 826C

EL 826G

Reflector with
Suspended
Glass lens
O.D.: 9"



EL 830B

EL 830W

Baffle Trim
with Reflector
O.D.: 9"



EL 842W

EL 842B

Regressed Lens
with Baffle
O.D.: 9"



EL 862G

EL 862C

Regressed Lens
with Reflector
O.D.: 9"



EL 888C

EL 888G

Cross Baffle
Reflector Trim
O.D.: 9"



7" Emergency Fluorescent Downlight

ELCO continues its tradition of quality with new Emergency downlights. Matching standard fixtures in appearance, these units provide 90 minutes of uniform emergency illumination for compact fluorescent lamps. All reflector systems maintain a 45° cutoff angle for superior glare control.

- Efficient, long-life 9W, 13W or 18W compact fluorescent lamp.
- 650 Lumen light output in emergency mode from a single 9W, 13W or 18W compact fluorescent lamp.
- Installs in night light or switchable circuits
- High-performance trims available
- Hanger Bar not included
- Energy Efficient
- U.L. listed

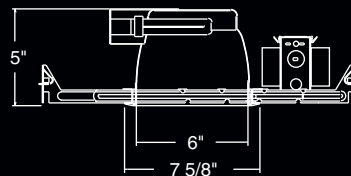

Height: 5 1/2" - Ceiling Opening: 6 1/2"
Frame Size: 11 3/4" x 11 7/8" - Trim O.D.: 7 1/2"

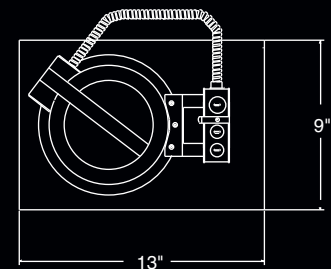

- ELH 7213EM** (2) 13W 120V N.P.F. Magnetic Ballast 2 Pin PL/Quad Lamp
- ELH 7218EM** (2) 18W 120V N.P.F. Magnetic Ballast 2 Pin Quad Lamp
- ELH 7213E-EM** (2) 13W 120/277V Electronic Ballast 4 Pin Quad Lamp
- ELH 7218E-EM** (2) 18W 120/277V Electronic Ballast 4 Pin Quad Lamp
- ELH 7126E-EM** (1) 26W 120/277V Electronic Ballast 4 Pin Quad Lamp

EL 721G
EL 721C
 Reflector Trim
 O.D.: 7 1/2"



EL 730B
EL 730W
 Reflector with
 Baffle Trim
 O.D.: 7 1/2"



EL 742W
EL 742B
EL 742N
 Regressed Lens with Baffle
 O.D.: 7 1/2"



EL 745W
EL 745B
 Wall Wash with
 Baffle Trim
 O.D.: 7 1/2"



EL 762G
EL 762C
 Reflector with
 Prismatic Lens
 O.D.: 7 1/2"



EL 777C
 Cross Baffle
 Reflector Trim
 O.D.: 7 1/2"



Compact Fluorescent Lamp Data

Lamp Wt. Type	Initial Lumens	Efficiency (LPW)	Life	CRI
9W Twin	600	67	10,000	82
13W Twin	900	69	10,000	82
13W Quad	860	67	10,000	82
18W Quad	1250	69	10,000	86

Lumen Comparison w/ Incandescent

Fluorescent		Incandescent	
Wattage	Lumens	Wattage	Lumens
2-9W Twin	1200	1-75W	1190
2-13W Twin	1800	1-100W	1750
2-13W Quad	1720	1-100W	1750
2-18W Quad	2500	1-150W	2850

Compact Fluorescent Lamp Data

High Power Fixture

# of Lamps Wt. Type	Voltage	Power	Total Watts	Oper. Amps	Power Factor	Total Watts	Oper. Amps
1-9W	120V	10.57	12	0.18	0.91	12	0.11
1-9W	277V	0.32	15	0.18	0.90	13	0.05
1-13W	120V	0.47	17	0.30	0.91	17	0.16
1-13W	277V	0.23	19	0.30	0.90	18	0.07
1-18W	120V	0.38	24	0.53	0.95	24	0.21
1-18W	277V	0.96	22	0.09	STD	STD	STD
1-26W	120V	0.41	32	0.65	0.95	32	0.28
1-26W	277V	0.94	30	0.12	STD	STD	STD
2-7W	120V	0.48	21	0.36	0.91	21	0.19
2-7W	277V	0.25	24	0.36	0.90	24	0.09
2-9W	120V	0.57	24	0.36	0.91	24	0.22
2-9W	277V	0.31	26	0.36	0.90	26	0.10
2-13W	120V	0.47	34	0.60	0.95	34	0.32
2-13W	277V	0.23	39	0.60	STD	39	0.16
2-18W	120V	0.38	48	1.06	0.95	48	0.42
2-18W	277V	0.96	44	0.17	STD	STD	STD

7" Emergency Fluorescent Downlight

ELCO continues its tradition of quality with new Emergency downlights. Matching standard fixtures in appearance, these units provide 90 minutes of uniform emergency illumination for compact fluorescent lamps. All reflector systems maintain a 45° cutoff angle for superior glare control.

- Efficient, long-life 9W, 13W or 18W compact fluorescent lamp.
- 650 Lumen light output in emergency mode from a single 9W, 13W or 18W compact fluorescent lamp.
- Installs in night light or switchable circuits
- High-performance trims available
- Hanger Bar not included
- Energy Efficient
- U.L. listed



Height: 5 1/2" - Ceiling Opening: 6 1/2"
Frame Size: 11 3/4" x 11 7/8" - Trim O.D.: 7 1/2"

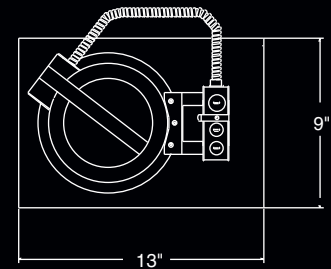
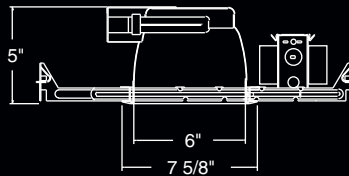

- ELH 7226E-EM** (2) 26W 120/277V Electronic Ballast 4 Pin Quad Lamp
- ELH 7132E-EM** (1) 32W 120/277V Electronic Ballast 4 Pin Triple Lamp
- ELH 7142E-EM** (1) 42W 120/277V Electronic Ballast 4 Pin Triple Lamp

**EL 731W, EL 731B,
EL 731N**

Reflector with Baffle Trim
O.D.: 7 5/8"



**EL 741G, EL 741C,
EL 741F**

Reflector Trim
O.D.: 7 5/8"



**EL 743W, EL 743B,
EL 743N**

Baffle with Regressed Lens
O.D.: 7 5/8"



EL 746B, EL 746W

Reflector Trim
O.D.: 7 5/8"



EL 778C

Chrome Reflector
with Cross Blades
O.D.: 7 5/8"



**EL 782G, EL 782B,
EL 782C, EL 782W**

Regressed Prismatic
Lens with Reflector
O.D.: 7 5/8"



Compact Fluorescent Lamp Data

Lamp Wt. Type	Initial Lumens	Efficiency (LPW)	Life	CRI
9W Twin	600	67	10,000	82
13W Twin	900	69	10,000	82
13W Quad	860	67	10,000	82
18W Quad	1250	69	10,000	86

Lumen Comparison w/ Incandescent

Fluorescent		Incandescent	
Wattage	Lumens	Wattage	Lumens
2-9W Twin	1200	1-75W	1190
2-13W Twin	1800	1-100W	1750
2-13W Quad	1720	1-100W	1750
2-18W Quad	2500	1-150W	2850

Compact Fluorescent Lamp Data

High Power Fixture

# of Lamps Wt. Type	Voltage	Power	Total Watts	Oper. Amps	Power Factor	Total Watts	Oper. Amps
1-9W	120V	10.57	12	0.18	0.91	12	0.11
1-9W	277V	0.32	15	0.18	0.90	13	0.05
1-13W	120V	0.47	17	0.30	0.91	17	0.16
1-13W	277V	0.23	19	0.30	0.90	18	0.07
1-18W	120V	0.38	24	0.53	0.95	24	0.21
1-18W	277V	0.96	22	0.09	STD	STD	STD
1-26W	120V	0.41	32	0.65	0.95	32	0.28
1-26W	277V	0.94	30	0.12	STD	STD	STD
2-7W	120V	0.48	21	0.36	0.91	21	0.19
2-7W	277V	0.25	24	0.36	0.90	24	0.09
2-9W	120V	0.57	24	0.36	0.91	24	0.22
2-9W	277V	0.31	26	0.36	0.90	26	0.10
2-13W	120V	0.47	34	0.60	0.95	34	0.32
2-13W	277V	0.23	39	0.60	STD	39	0.16
2-18W	120V	0.38	48	1.06	0.95	48	0.42
2-18W	277V	0.96	44	0.17	STD	STD	STD

7" Emergency Fluorescent Downlight with Plaster Frame

ELCO continues its tradition of quality with new Emergency downlights. Matching standard fixtures in appearance, these units provide 90 minutes of uniform emergency illumination for compact fluorescent lamps. All reflector systems maintain a 45° cutoff angle for superior glare control.

- Efficient, long-life 9W, 13W or 18W compact fluorescent lamp.
- 650 Lumen light output in emergency mode from a single 9W, 13W or 18W compact fluorescent lamp.
- Installs in night light or switchable circuits
- Includes Hanger Bars
- High-performance trims available
- Energy Efficient
- U.L. listed

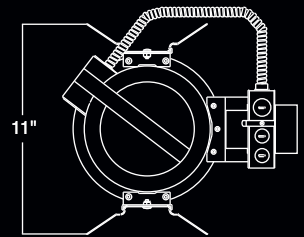
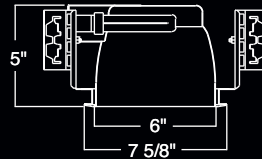

Height: 5 1/2" - Ceiling Opening: 6 1/2"
Frame Size: 12 3/4" x 9 1/2" - Trim O.D.: 7 1/2"

ELH 213EM (2) 13W 120V PL Lamp H.P.F. Magnetic Ballast
ELH 218EM (2) 18W 120V PL Lamp H.P.F. Magnetic Ballast

ELH 213E-EM (2) 13W 120/277V PL Lamp H.P.F. Electronic Ballast
ELH 218E-EM (2) 26W 120/277V PL Lamp H.P.F. Electronic Ballast

EL 721G
EL 721C
 Reflector Trim
 O.D.: 7 1/2"



EL 730B
EL 730W
 Reflector with
 Baffle Trim
 O.D.: 7 1/2"



EL 742W
EL 742B
EL 742N
 Regressed Lens with Baffle
 O.D.: 7 1/2"



EL 745W
EL 745B
 Wall Wash with
 Baffle Trim
 O.D.: 7 1/2"



EL 762G
EL 762C
 Reflector with
 Prismatic Lens
 O.D.: 7 1/2"



EL 777C
 Cross Baffle
 Reflector Trim
 O.D.: 7 1/2"



Compact Fluorescent Lamp Data

Lamp Wt. Type	Initial Lumens	Efficiency (LPW)	Life	CRI
9W Twin	600	67	10,000	82
13W Twin	900	69	10,000	82
13W Quad	860	67	10,000	82
18W Quad	1250	69	10,000	86

Lumen Comparison w/ Incandescent

Fluorescent		Incandescent	
Wattage	Lumens	Wattage	Lumens
2-9W Twin	1200	1-75W	1190
2-13W Twin	1800	1-100W	1750
2-13W Quad	1720	1-100W	1750
2-18W Quad	2500	1-150W	2850

Standard Fixture (N.P.F.)

High Power Fixture (H.P.F.)

# of Lamps Wt. Type	Voltage	Power Factor	Total Watts	Oper. Amps	Power Factor	Total Watts	Oper. Amps
1-9W	120V	10.57	12	0.18	0.91	12	0.11
1-9W	277V	0.32	15	0.18	0.90	13	0.05
1-13W	120V	0.47	17	0.30	0.91	17	0.16
1-13W	277V	0.23	19	0.30	0.90	18	0.07
1-18W	120V	0.38	24	0.53	0.95	24	0.21
1-18W	277V	0.96	22	0.09	STD	STD	STD
1-26W	120V	0.41	32	0.65	0.95	32	0.28
1-26W	277V	0.94	30	0.12	STD	STD	STD
2-7W	120V	0.48	21	0.36	0.91	21	0.19
2-7W	277V	0.25	24	0.36	0.90	24	0.09
2-9W	120V	0.57	24	0.36	0.91	24	0.22
2-9W	277V	0.31	26	0.36	0.90	26	0.10
2-13W	120V	0.47	34	0.60	0.95	34	0.32
2-13W	277V	0.23	39	0.60	STD	39	0.16
2-18W	120V	0.38	48	1.06	0.95	48	0.42
2-18W	277V	0.96	44	0.17	STD	STD	STD

7" Compact Fluorescent Emergency IC Downlight

Compact fluorescent emergency IC housing with plaster frame. For (2) horizontally mounted lamps with integral fluorescent ballast. Damp location listed. Feed through listed. 7 1/4" height allows use in 2 x 8 construction. Trim support adjusts 3/4" to accommodate different ceiling thicknesses. 24" captive hanger bars included. For direct contact with insulation.

- Efficient, long-life compact fluorescent lamp not included.
- 650 Lumen light output in emergency mode from single compact fluorescent lamp
- Emergency frame-in module includes electronics and battery pack
- Installs in night light or switchable circuits
- High-performance trims available
- Hanger Bar included
- Energy Efficient
- U.L. listed

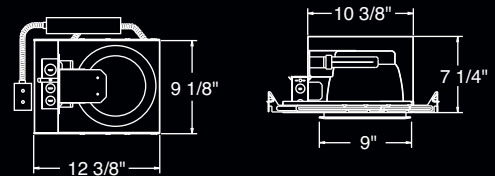

Height: 7 1/4" - Ceiling Opening: 8 1/4"
Trim O.D.: 7 1/2"

ELH213IC-EM (2) 13W PL/Quad 120V N.P.F. magnetic Ballast
ELH213ICE-EM (2) 13W Quad 4 Pin 120/277V Electronic Ballast

EL 721G
EL 721C
Reflector Trim
O.D.: 7 1/2"



EL 730B
EL 730W
Reflector with
Baffle Trim
O.D.: 7 1/2"



EL 745W
EL 745B
Wall Wash with
Baffle Trim
O.D.: 7 1/2"



EL 742W
EL 742B
Regressed Lens
with Baffle
O.D.: 7 1/2"



EL 762G
EL 762C
Regressed with
Prismatic Lens
O.D.: 7 1/2"



EL 777C
Cross Baffle
Reflector Trim
O.D.: 7 1/2"



7" Compact Fluorescent Emergency Downlight

Attractive, dependable and maintenance-free, the Emergency advantage series is ideal for contemporary lighting applications. High temperature nickel cadmium batteries and solid-state electronics ensure a long, dependable servicelife. The Emergency advantage series matches standard fluorescent advantage downlights in appearance and automatically provides 90 minutes of emergency operation for 13W, 26W, 32W, or 42W compact fluorescent lamps upon total or isolated power failure.

- Efficient, long-life compact fluorescent lamp not included.
- 650 Lumen light output in emergency mode from single compact fluorescent lamp
- Emergency frame-in module includes electronics and battery pack
- Installs in night light or switchable circuits
- High-performance trims available
- Hanger Bar included
- Energy Efficient
- U.L. listed

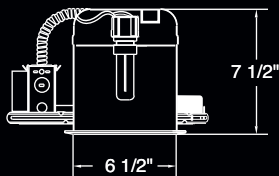
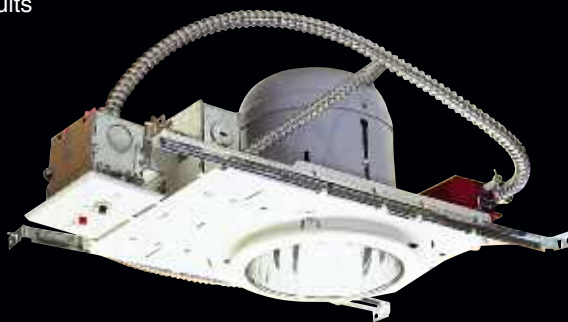

Height: 6 5/8" - Ceiling Opening: 8"
 Frame Size: 7 1/2" X 10 1/2" - Trim O.D.: 7 1/4"

EL 12W
EL 12G
EL 12N
 Reflector
 O.D.: 7 1/4"



EL 13W
EL 13G
EL 13N
 Reflector
 O.D.: 7 1/4"



ELA 99SC
 Clear Reflector
 O.D.: 7 1/4"



ELA 99SG
 Gold Reflector
 O.D.: 7 1/4"



EL 27HIC-EM (1)13W 120V IC Type PL Lamp N.P.F. Magnetic Ballast

EL 27HE26-EM (1) 26W 120/277V PL-T 4 Pin Electronic Ballast

EL 27HE32-EM (1) 32W 120/277V PL-T 4 Pin Electronic Ballast

EL 27HE42-EM (1) 42/32/26W 120/277V PL-T 4 Pin Electronic Ballast

Standard Fixture (N.P.F.)					High Power Fixture (H.P.F.)		
# of Lamps Wt. Type	Voltage	Power Factor	Total Watts	Oper. Amps	Power Factor	Total Watts	Oper. Amps
1-7W	120V	0.48	11	0.18	0.91	11	0.10
1-7W	277V	0.25	12	0.18	0.90	12	0.05
1-9W	120V	0.57	12	0.18	0.91	12	0.11
1-9W	277V	0.31	15	0.18	0.90	13	0.05
1-13W	120V	0.47	17	0.30	0.95	17	0.16
1-13W	277V	0.23	19	0.30	STD	18	0.07
1-18W	120V	0.38	24	0.53	0.95	24	0.21
1-18W	277V	0.96	22	0.09	STD	STD	STD
1-26W	120V	0.41	32	0.65	0.95	32	0.28
1-26W	277V	0.94	30	0.12	STD	STD	STD

7" Compact Fluorescent Emergency Downlight Trims (Cont.)

ELA 99SW

ELA 99SB

White Reflector

O.D.: 7 1/4"



ELA 101B

Black Baffle

O.D.: 7 1/4"



ELA 101W

White Baffle

O.D.: 7 1/4"



ELS 30B

ELS 30C

ELS 30G

ELS 30W

Reflector

O.D.: 7 1/4"



ELS 40C

ELS 40G

Reflector

O.D.: 7 1/4"



EL 12SH

Reflector

O.D.: 7 1/4"



EL 13SH

Reflector

O.D.: 7 1/4"



Emergency Pack



KEM-P13

(with switch plate)

For (1) 9W, (1) 13W, (2) 9W, (2) 13W
120V or 277V fixtures. 2 pin (Magnetic)

KEM-P26

(with switch plate)

For (1) 18W, (1) 26W, (2) 18W, (2) 26W
120V or 277V fixtures. 2 pin (Magnetic)

KEM-P32

(Junction Box mounting with switch plate)

Single whip with bottom leads and stud for
J box installation for (1) 13W-42W, (2) 13W-42W fixtures.
4 pin (Electronic)

KEM-P42

(Double whip with switch plate)

For (1) 13W-42W, (2) 13W-42W 120V or 277V fixtures.
4 pin (Electronic)



KEM-P43

(Double whip with combination switch)

For (1) 13W-42W, (2) 13W-42W 120V or 277V fixtures.
4 pin (Electronic)

6" Low Voltage Emergency Downlight

EL 7LV-EM

6" Standard Low Voltage Emergency Housing
Height: 7 1/2" - Opening: 6 1/2"
Lamp: 12V-50W-MR16 or PAR36

- Low voltage housing utilizes MR16 halogen lamp, includes Emergency Relay Unit for remote battery supply. (Remote battery unit sold separately)
- Complete with 12 volt thermally protected Magnetic transformer.
- Captive hanger bars span 24" joists and can be repositioned 90 degrees.
- 7 1/2" Height allows for use in 2 x 8 construction.
- Housing adjusts 1 3/8" to accommodate various ceiling thickness.
- U.L. Listed for damp location
- U.L. Feed through Listed
- Compatible Trims shown on pages 62-64



5" Low Voltage Emergency Downlight

EL 5LV-EM

5" Low Voltage Emergency Housing
Height: 7 1/2" - Ceiling Opening: 5 1/2"
Lamp: 12V -50W MR16

- Low voltage housing utilizes MR16 halogen lamp, includes Emergency Relay Unit for remote battery supply. (Remote battery unit sold separately)
- Integral thermal protector guards against misuse of insulation materials and improper lamping.
- Trim assembly and lamp not included.
- Junction box is listed for through branch circuit wiring and has 1/2" knockouts with true pry-out slots.
- Captive bar hangers span 24" joists and can be repositioned 90°.
- 7 1/2" height allows for use in 2 x 8 construction.
- Housing adjusts 1 3/8" to accommodate various ceiling thicknesses.
- UL listed damp location.
- UL listed feed through.
- Compatible Trims shown on pages 69-72



4" Low Voltage Emergency Downlight

EL 1499-EM, EL 1499A-EM, EL 1499-277-EM

Low Voltage Emergency Housing

Height: 5 1/2" - Ceiling Opening: 4 1/4"

Lamp: 12V-50W-MR16

- Low voltage housing utilizes MR16 halogen lamp, includes Emergency Relay Unit for remote battery supply. (Remote battery unit sold separately)
- Housing is a thermally protected.
- Integral thermal protector guards against improper lamping.
- Junction box is listed for through branch circuit wiring and has (six) 1/2" knockouts with true pry-outs slots.
- Captive bar hangers span 24" joists and can be repositioned 90°.
- Housing adjusts 3/4" to accommodate various ceiling thickness.
- U.L. listed
- A= ASTM Airtight Fixture
- Compatible Trims shown on pages 82-90



3" Low Voltage Emergency Downlight

EL 2699-EM, EL 2699A-EM

3" Low Voltage Housing

Opening: 3 5/8" - Height: 4 7/8"

Cutout Hole Size: 3 3/4"

- Low voltage housing utilizes MR16 halogen lamp, includes Emergency Relay Unit for remote battery supply. (Remote battery unit sold separately)
- 3" Low Voltage Housing with thermal protector.
- Includes 12V, Magnetic Transformer.
- Hanger bars for 24" joists included.
- Lamp: 12V, MR16 bi-pin (not included)
- UL Listed for damp locations.
- Cutout Hole Size 3 3/4"
- U.L. Listed for damp locations
- A= ASTM Airtight Fixture
- Compatible Trims shown on pages 93-96



Emergency Retrofit Kits for 6" Incandescent Housing

Emergency Battery Back up Retrofit Kits for Standard 6" Incandescent Housings

- Battery Back up/Charger board replaces existing housings socket bracket.
- Screw base adaptor attaches to housing socket.
- 6Volt maintenance free lead-calcium battery for 90min. Emergency operation (for 15W lamp)
- Easy installation
- Test switch and charge indicator light on the trim
- Various adjustable trims
- For use Residential Commercial Applications
- Can be wired for 277V input voltage



ELR 317W
ELR 317G
ELR 317BZ
ELR 317CP

Adjustable Gimbal Ring
Lamp: 12W, 6V PAR36
O.D.: 8"



ELR 376B
ELR 376N
ELR 376W

Reflector with Regressed Gimbal
Lamp: 12W, 6V PAR36
O.D.: 7 1/4"



ELR 2533B
ELR 2533W
ELR 2533BZ
ELR 2533CP
ELR 2533BBZ
ELR 2533BCP

Adjustable Baffle Trim
Lamp: 10W, 6V MR16
I.D.: 3 1/2"
O.D.: 7 1/4"



Accessories

Elco Lighting carries a wide variety of color filters and specialty lenses to help you create the perfect mood or setting. Different colored and oversized trim rings give you the greatest options for creative recessed lighting. Elco has socket adapters and extenders, a hole saw that accommodates every remodel application (cutting through drywall, plywood, plaster, and acrylic sheeting to 7/8" thick), American-made magnetic and electronic transformers and low voltage, incandescent, high-pressure sodium, H.I.D. metal halide and fluorescent lamps.

- Rope Lighting
- LAMPS
- HOLE SAWS
- ACCESSORIES

238-249

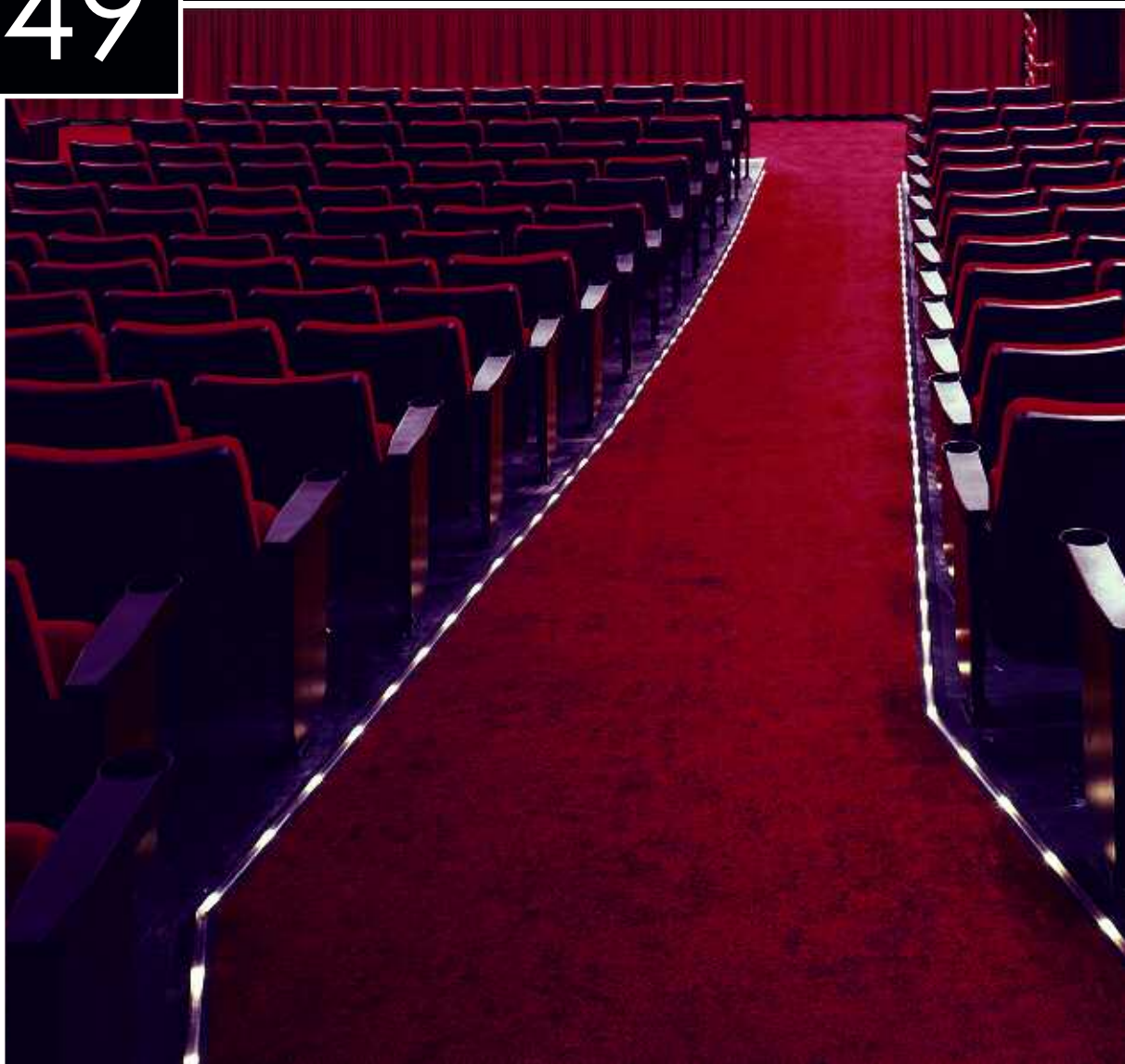

Adjustable Round Hole Cutter

Install any size can 1/4" to 8 1/4", Elco, Halo, Capri, Juno, with Elco's Adjustable Hole Saw



EL 5000 (Medium) Cuts 1 1/4" to 6 1/2" hole

EL 6000 (Large) Cuts 2" to 8 1/4" hole

- EL 5001 Drill Bit
- EL 5002 Upright Axel
- EL 5003 Traverse Axel
- EL 5004A Blade A for Drywall
- EL 5004B Blade B for Stucco
- EL 5007 Adjustable Rod
- EL 5013 Protection Cowl
- EL 5016 Compression Spring
- EL 5018 Set of Balance Bars
- EL 5019 Allen Wrench
- EL 6003 Traverse Axle for EL6000
- EL 6013 Protection Cowl for EL6000

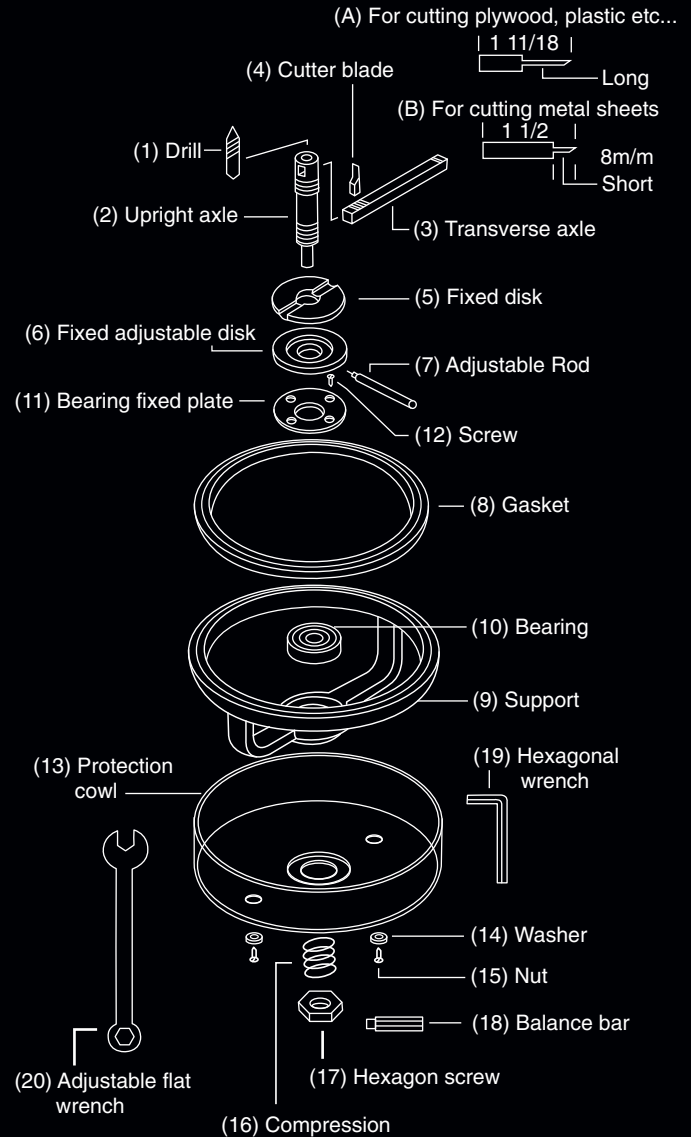

Adjustable Round-Hole Cutter

- For fast installation of recessed lighting fixtures.
- Can cut drywall, plywood, plaster and acrylic sheeting up to 7/8" thick (1 3/4" thick if opposite side can also be drilled)
- For cutting aluminum, brass and metal sheets up to 1/16" thick.
- Transparent cowl prevents chips from injuring user
- Minimum cutting diameter 1 3/4"
- Maximum cutting diameter 6 1/2"
- Can work with either variable speed hand drill or drill press

Accessories for Recessed and Track Fixtures

Colored Lens MR 16 Color Filters for use with MR16 Lamp units.

- | | | | |
|-----|----------------------|-----|------------------------------|
| L28 | Clear Lens | L38 | Honey Comb Louver Lens |
| L29 | Red Lens | L39 | Honey Comb Louver Black Lens |
| L30 | Yellow Lens | L40 | Honey Comb Louver |
| L31 | Blue Lens | L41 | Honey Comb Louver |
| L32 | Frosted Lens | L42 | Spread Lens |
| L33 | Soft Lens | L43 | Linear Spread Lens |
| L34 | Diffused Spread Lens | L44 | Soft Spread Lens |
| L35 | Linear Spread Lens | | |
| L36 | Green Lens | | |



Socket Adapters

PSA25 Socket Adapter for Halo® 5" trims to fit Elco Housings

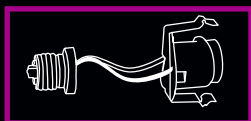

PSA28 Medium base screw into MR16, G8 base (50W,120V MR16 lamp included)



PSE26 Socket extender



PSA29 Medium base screw into MR16, GU10 base (50W,120V MR16 lamp included)



PSA27 Medium socket adapter

PSA36 Socket extender

3" Metal Rings

- RM3B Black 3" Trim Ring
 - RM3C Chrome 3" Trim Ring
 - RM3G Gold 3" Trim Ring
 - RM3N Nickel 3" Trim Ring
 - RM3W White 3" Trim Ring
 - NEW!** RM3BZ Bronze 3" Trim Ring
 - NEW!** RM3CP Copper 3" Trim Ring
- O.D. 4 1/4"



4" Metal Rings

- OM4B Oversized Black 4" Trim Ring
 - OM4W Oversized White 4" Trim Ring
 - RM4B Black 4" Trim Ring
 - RM4C Chrome 4" Trim Ring
 - RM4G Gold 4" Trim Ring
 - RM4N Brushed Nickel 4" Trim Ring
 - RM4W White 4" Trim Ring
 - NEW!** RM4BZ Bronze 4" Trim Ring
 - NEW!** RM4CP Copper 4" Trim Ring
- O.D. 4 3/4" Regular Ring
O.D. 5 1/2" Over size Ring



5" Metal Rings

- OM5B Oversized Black 5" Trim Ring
 - OM5W Oversized White 5" Trim Ring
 - RM5B Black 5" Trim Ring
 - RM5C Chrome 5" Trim Ring
 - RM5G Gold 5" Trim Ring
 - RM5N Brushed Nickel 5" Trim Ring
 - RM5W White 5" Trim Ring
 - NEW!** RM5BZ Bronze 5" Trim Ring
 - NEW!** RM5CP Copper 5" Trim Ring
- O.D. 6 1/4" Regular Ring
O.D. 7 1/4" Over size Ring



6" Metal Rings

- OVM7W Metal Oversize Ring, White
 - OVP7B Black Plastic Oversized Trim Ring
 - OVP7W White Plastic Oversized Trim Ring
 - RM7B Black 7" Metal Trim Ring
 - RM7C Chrome 7" Metal Trim Ring
 - RM7G Gold 7" Metal Trim Ring
 - RM7N Brushed Nickel 7" Metal Trim Ring
 - RM7W White 7" Metal Trim Ring
 - NEW!** RM7BZ Bronze 7" Trim Ring
 - NEW!** RM7CP Copper 7" Trim Ring
 - RP7B Black Plastic 6" Trim Ring
 - RP7W White Plastic 6" Trim Ring
- O.D. 7 1/4" Regular Ring
O.D. 8" Over size Ring



7" Metal Rings

- RM8W White 7" Trim Ring
- O.D. 7 1/2"



8" Metal Rings

- RM9W White 8" Trim Ring
- O.D. 9"



Hanger Bars

CH 26
Hanger Bars
for Commercial Frames
Set of 2-26"
for T-Bar Ceiling

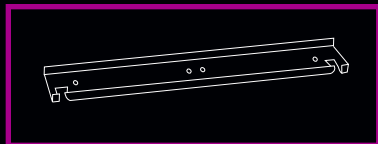

FB 27
Set of two 27" flat
hanger bars for
commercial frames.
For wood construction

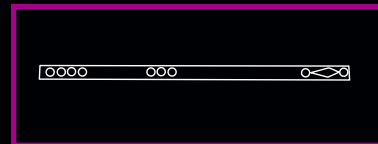

Socket Wire for 6" Cans

P0 12S
Socket wire and Thermal
Protector for EL7IC and
R10H

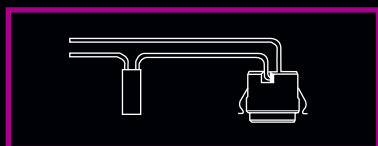

Socket for MR16

P016S Socket for
MR16 with 24" wires.



P006S Socket for MR16 with
6" wires, no disk.



Replacement Parts

SPRING
Coil Spring for ELM 30

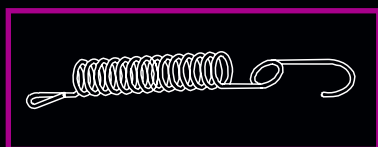

HB 24
Replacement Hanger Bars
for Plaster Frames
IE: EL7IC, EL99, ETC
set of 2, 24"

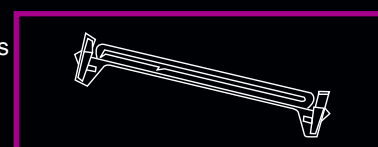

NEW! V-SPRING

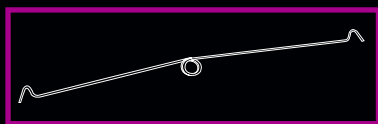

Insulation Sensor

RP 5A
Insulation sensor
for H.I.D. fixtures
120/277V

RP 1B
Insulation sensor
for Incandescent fixtures
120V



Emergency Kits

KEM-P13
Emergency battery back-up ballast for fluorescent
 housings with (1) 9W, (1) 11W, (2) 9W, (2) 13W 2
 Pin lamps, 120V or 277V

KEM-P32
Emergency battery back-up ballast for Compact
 Fluorescent Fixtures with (1) 13W-42W, (2) 13W-42W
 4 Pin lamps, 120V or 277V electronic J box mount

KEM-P26
Emergency battery back-up ballast for fluorescent
 housings with (1) 18W, (1) 26W, (2) 18W, (2) 26W
 2 Pin lamps, 120V or 277V

KEM-P42
Battery back up for Electronic (1) 13W-42W, (2) 13W-
 42W, 120V or 277V fixtures, 4 Pin, 2 flex ballast



NEW! **KEM-P43**
Battery back up for Electronic (1) 13W-42W, (2) 13W-
 42W, 120V or 277V fixtures, 4 Pin with Combo Switch

Set of 3 Retrofit Clips

CLIP-1

Set of 3 Retrofit Clips.



CLIP-2

Set of 3 Retrofit Clips.



L-BRCKT

Socket plate for 6" housing.
With screw and wing nut



CLIP721

Set of 3 Clips For EL 721



CLIP-R

Set of 3 Clips For Remodel Housing



CLIP-4

Set of 3 Retrofit Clips.



T-SWITCH

Test switch for KEM battery
Backups



Ballast

NEW! P113E1

1-13 Electric Ballast 120V

P118DX

1-18 Mark X Ballast 120V Dimming
Ballast, 120V

NEW! P118E1

1-18 Electric Ballast 120V

NEW! P126E1

1-26 Electric Ballast 120V

P142DU

1 32-42 or 2 13-26
Dimming Ballast 120/277V, Mark 7

P142DX

1 26-42 Mark X Dimming
Ballast, 120V

P142EU

1 42/32/26 or 2 -26
Universal Electric Ballast

P213EU

2/1 13W Universal Electric
Ballast 120/277V

P218DX

2-18 Mark X Dimming Ballast,
120V

NEW! P218EU

2/1 18W Universal Electric
Ballast

P226DX

2-26 Mark X Dimming
Ballast, 120V

P242DU

2-42/32W Universal Dimming
Ballast 120/277V

P242DX

2-32/42W Mark X Ballast 120V

P242EU

2 42/32/26 or 2 -26
120/277V

PWH2E1

1-32/26/18/13W 2-13W Electronic Ballast, 120V

NEW! P142DX-7

(1) 26-42 Mark X Ballast, 277V

P142D1

(2) 26, (1) 26-42, N.P.F. Dimming Ballast, 120V

P218D1

(2/1) 18W, N.P.F. Dimming Ballast, 120V



NEW! P035MH 39W Metal Halide Ballast 120/277V Enclosed, Magnetic, for Recessed Downlights

P035MHE1 39W Metal Halide Electronic Ballast 120V, for Track Fixtures

P035MHE2 39W Metal Halide Electronic Ballast 120/277V, for Recessed Downlights



NEW! P050HP 50W H.P.S. Ballast 120/277V Enclosed, Magnetic, for Recessed Downlights

NEW! P050MH 50W Metal Halide Ballast 120/277V Enclosed, Magnetic

P050MHE2 50W Metal Halide Electronic Ballast 120V, for Recessed Downlights

NEW! P070HP 70W H.P.S. Ballast 120/277V Enclosed, Magnetic

NEW! P070MH 70W Metal Halide Ballast 120/277V Enclosed, Magnetic

P070MHE1 70W Metal Halide Electronic Ballast 120V, for Track Fixtures

P070MHE2 70W Metal Halide Electronic Ballast 120/277V, for Recessed Downlights

NEW! P100HP 100W H.P.S. Ballast 120/277V Enclosed, Magnetic

NEW! P100MH 100W Metal Halide Ballast 120/277V Enclosed, Magnetic

P100MHE1 100W Metal Halide Electronic Ballast, 120V, for Track Fixtures

P100MHE2 100W Metal Halide Electronic Ballast, 120/277V for Recessed Fixtures



P150MHE2 150W Metal Halide Ballast, 120/277V, Electronic for Recessed Downlights

P150HP 150W H.P.S. Ballast 120/277V Enclosed

P175MH 175W Metal Halide Ballast 120/277V Enclosed

P150MH 150W Metal Halide Ballast 120/277V Enclosed

P250MH 250W Metal Halide Ballast 120/277V Enclosed



Lamps - Low Voltage

MR 11NSP Low voltage MR11, 12V (NSP) Bi-pin, G4 base, 20W

MR 16EXN Low voltage MR11, 12V (FL) Bi-pin, G5.3 base, 50W

MR 11NFL Low voltage MR11, 12V (NFL) Bi-pin, G4 base, 35W

MR 16EYC Low voltage MR11, 12V (FL) Bi-pin, G5.3 base, 65W

MR 16EXZ Low voltage MR11, 12V (NFL) Bi-pin, G5.3 base, 50W

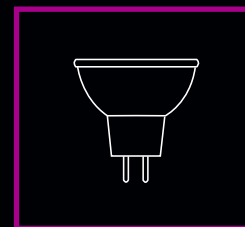

Lamps



PAR Lamps Incandescent



PAR 20

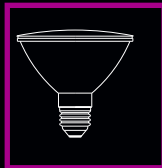

PAR 30

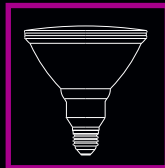

PAR 38

MR 120

MR16
G8, Base
120V Input
50W bi-pin base

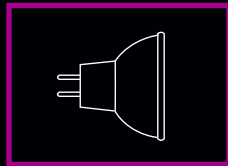

JDR (face)

MR16
G5.3, Base
120V Input
40W Medium base

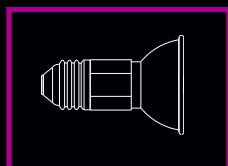

H.I.D.

PAR 20F35M

PAR20, Flood beam Spread
39W
Metal Halide. Medium base

PAR 20S35M

PAR20, Spot beam Spread
39W
Metal Halide. Medium base

PAR 30F70M

PAR30, Flood beam Spread
70W
Metal Halide. Medium base

PAR 30S70M

PAR30, Spot beam Spread
70W
Metal Halide. Medium base

PAR 30S35M

PAR30, Spot beam Spread
39W, long neck
Metal Halide, Medium base

PAR 38F70M

PAR38, Flood beam
70W,
Metal Halide, Medium base

PAR 38F100M

PAR38, Flood beam
120V, 100W
Metal Halide. Medium base

PAR 20S50

PAR20, Narrow Spot beam
120V, 50W
Medium base

PAR 20F50

PAR20, Narrow Flood beam
120V, 50W
Medium base

PAR 30S75

PAR30, Narrow Spot beam
120V, 75W
Medium base

PAR 30F75

PAR30, Flood Medium beam
120V, 75W

PAR 38F90

PAR38, Flood beam
120V, 90W
Medium base

PAR 38F120

PAR38, Narrow Flood beam
120V, 120W
Medium base

Lamps - H.I.D. Metal Halide

MVR 32

ED17 Metal Halide
Lamp 32W
Medium Base

MVR 70

ED17 Metal Halide
Lamp 70W
Medium Base

MVR 100

ED17 Metal Halide
Lamp 100W
Medium Base

MVR 150

ED17 Metal Halide
Lamp 150W
Medium Base

MVR 175

ED17 Metal Halide
Lamp 175W
Medium Base

MVR 250

ED28 Metal Halide
Lamp 250W
Mogul Base

MVR 400

ED28 Metal Halide
Lamp 400W
Mogul Base

Lamps: H.I.D. High Pressure Sodium

LU 35

ED17 H.P.S.
Lamp 35W
Medium Base

LU 50

ED17 H.P.S.
Lamp 50W
Medium Base

LU 70

ED17 H.P.S.
Lamp 70W
Medium Base

LU 100

ED17 H.P.S.
Lamp 100W
Medium Base

LU 150

ED17 H.P.S.
Lamp 150W
Medium Base

LU 250

ED28 H.P.S.
Lamp 250W
Mogul Base

LU 400

ED28 H.P.S.
Lamp 400W
Mogul Base

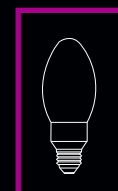

Medium Base

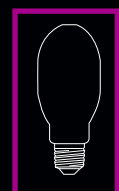

Mogul Base

Lamps - Compact Fluorescent

P 7

Twin Tube C.F.L. 7W
2 Pin G23 Base

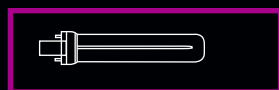

O.A.L. 5.30"

P 18T-4

Triple Biax 18W C.F.L.
4 Pin GX24q-2 Base



O.A.L. 4.8"

P 9

Twin Tube C.F.L. 9W
2 Pin G23 Base

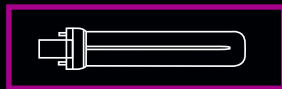

O.A.L. 6.60"

P 26

Quad Tube 26W C.F.L.
2 Pin GX24d-3 Base



O.A.L. 6.7"

P 13

Twin Tube 13W C.F.L.
2 Pin GX23 Base

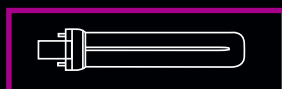

O.A.L. 7.00"

P 26-4

Triple Biax 26W C.F.L.
4 Pin GX24q-3 Base



O.A.L. 6.4"

P 13Q

Quad Tube 13W C.F.L.
2 Pin GX23-2 Base

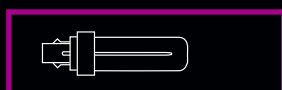

O.A.L. 6.64"

P 26T-4

Triple Biax 26W C.F.L.
4 Pin GX24q-3 Base

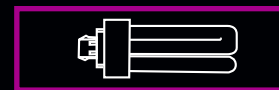

O.A.L. 5.2"

P 13-4

Quad Tube 13W C.F.L.
4 Pin G24q-1 Base

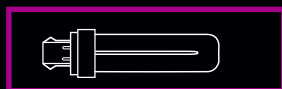

P13T-4"

P 32T-4

Triple Biax 32W C.F.L.
4 Pin GX24q-3 Base



O.A.L. 5.8"

P 13T-4

Triple Biax 13W C.F.L.
4 Pin G24q-1 Base



O.A.L. 6.10"

P 42Q-4

Triple or Quadruple Biax
42W C.F.L. 4 Pin
GX24q-4 Base



O.A.L. 6"

P 18

Quad Tube 18W C.F.L.
2 Pin G24d-2 Base

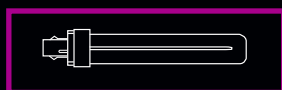

O.A.L. 5.65"

C.F.L. = Compact Fluorescent Lamp

O.A.L. = Overall Length

P 18-4

Quad Tube 18W C.F.L.
4 Pin G24q-2 Base



O.A.L. 5.30"

ELCO Lighting

"We had four primary objectives... be within budget parameters, use existing dimming system, achieve acceptable light levels and reduce energy cost. We accomplished all four of them with the Elco products."

Portland Marriott Hotel
Senior Engineer William Moore

"We beat their **quality, availability,**
and of course their **price**"

Come visit our website at www.elcolighting.com

2042 E. Vernon Ave.,
Vernon, CA 90058
TEL 323-231-2600
FAX 323-231-3200



Displays

Display-FT, DT

DISP-DT

2' x 2' drop-in for T-BAR Ceiling.
(3) 6" Low Voltage Housing.
(3) 6" Line Voltage Housing.
Individually Switched

DISP-FT

2' x 2' x 6" Chain mounted Display Box.
(3) 1.5' Tracks.
Drop: up to 24"

Display-2

DISP-D2

2' x 2' drop-in for T-BAR Ceiling.
(3) 1.5' Tracks.

DISP-F2

2' x 2' drop-in for T-BAR Ceiling.
(3) Mini Halogen Light
(3) Mini Halogen Surface Mount

Display-3

DISP-D3

2' x 2' Chain mounted display box.
96) 3" low voltage housings.

DISP-F3

2' x 2' drop-in display panel with
(6) 3" low voltage housings.

Display-4

DISP-D4

2' x 2' drop-in for T-BAR Ceiling.
(2) 6" Low Voltage Housing.
(2) 6" Line Voltage Housing.
Individually Switched

DISP-F4

2' x 2' x 6" Chain mounted Display Box.
(3) 4" Low Voltage Housing.
(3) 4" Line Voltage Housing.
Individually Switched
Drop: up to 24"

Display-5

DISP-D5

2' x 2' x 6' chain hung display box with
(4) 5" Housings. Line Voltage.

DISP-F5

2' x 2' drop in display panel with
(4) 5" Housings.

Display-6

DISP-D6

2' x 2' x 6' chain mounted display box.
(4) 6" Line Voltage Housing.
Drop: up to 24"

DISP-F6

2' x 2' x 6" Chain mounted Display Box.
(2) 6" Low Voltage Housing.
(2) 6" Line Voltage Housing.
Individually Switched
Drop: up to 24"

Display-7

DISP-D7

2' X 2' x 6" Chain mount display with
(1) 7" Horizontal CFL for 2 x 26W lamp
(1) 6" Vertical CFL for 1 x 26W lamp
(1) 5" Vertical CFL for 1 x 26W lamp
(1) 4" CFL for 1 x 18W lamp

DISP-F7

2' X 2' Drop-in display panel with
(1) 7" Horizontal CFL for 2 x 26W lamp
(1) 6" Vertical CFL for 1 x 26W lamp
(1) 5" Vertical CFL for 1 x 26W lamp
(1) 4" CFL for 1 x 18W lamp



DISP-D2



DISP-D4



DISP-D6

Housings	Reflectors - (Lamps)	Baffles - (Lamps)	Adjustable - (Lamps)
EL900HT EL900RT	EL616 - 150W, PAR38, 150W, R40	EL622K - 150W PAR or R EL624 - 75W PAR30 EL626 - 150W PAR38	EL610 - 75W JDR EL611 - 75W JDR EL618 - 700W PAR30 or R30
EL918IC EL918ICA EL918RIC	EL616 - 75W PAR30, 75W PAR38, 75W R30,75W R40	EL622K - 75W PAR38 EL624 - 75W PAR30 EL626 - 150W PAR38	EL601 - 75W PAR30 or R30 EL610 - 75W JDR EL619 - 75W PAR30 or R30 EL624 - 75W PAR30
EL936IC EL936ICA	EL616 - 90W PAR38, 75W PAR30, 60W A19	EL622K - 90W PAR38 EL601 - 75W PAR30	EL610 - 75W JDR EL618 - 100W PAR30 or R30
ELH8T	EL816 - 200W A or PAR	EL833 - 200W A or PAR	
ELH7T	EL716 - 150W A, PAR or R	EL733 - 150W A, PAR or R	
EL7IC EL7ICA EL7RIC	ELA105 - 60W A19 ELA99 - 60W A19 ELS30 - 75W R30 PAR30 ELS40 - 75W PAR or R EL599 - 75W PAR20 or R20	EL304 - 75W PAR or ELA101 - 40W A19 ELM40 - 75W PAR or R ELP30 - 75W PAR or R EL79 - 50W PAR or R EL593 - 75W PAR20 or R20	EL17 - 75W PAR or R EL18 - 75W PAR or R EL376 - 75W PAR30 EL476 - 75W PAR38 ELM48 - 75W PAR or R EL77 - 75W R20 EL377 - 75W PAR30 EL419 - 75W PAR or R EL588 - 75W PAR16 EL317 - 75W PAR30 EL318 - 75W PAR38 EL477 - 75W PAR38
EL7IC100 EL7IC100A	ELA105 - 60WA19 ELA99 - 75W A19 ELS30 - 75W PAR30 or R30 ELS40 - 100W PAR or R EL599 - 75W PAR20 or R20	EL304 - 75 PAR or R ELA101 - 60W A19 ELM40 - 100W PAR or R ELP30 - 75W R EL79 - 50W PAR or R EL593 - 75W PAR20	EL17 - 100W PAR or R EL18 - 100W RPAR or R EL376 - 75W PAR EL476 - 75W PAR ELM48 - 75W PAR or R EL77 - 50W PAR20 or R20 EL377 - 75W PAR EL419 - 75W PAR or R EL588 - 75W JDR EL317 - 75W PAR30 EL318 - 100W PAR38 EL477 - 75W PAR38
R10H RR10H	ELS30 - 150W PAR or R ELS40 - 150W PAR or R ELA105 - 60W A19 ELA95 - 60W A19 ELA99 - 100W A19 EL377 - 75W PAR30	ELM30 - 75W PAR or R ELM304 - 75W PAR or R ELP30 - 75W PAR or R EL101 - 100W A19 EL304 - 75W PAR or R EL593 - 75W PAR20 or R20 EL599 - 75W PAR20 or R20 ELM40 - 150W PAR or R	EL17 - 75W PAR30 or R30 EL18 - 75W PAR30 or R30 EL376 - 75W PAR30 EL476 - 150W PAR38 ELM48 - 75W PAR30 or R30 EL77 - 50W R20 EL377 - 75W PAR30 EL419 - 75W PAR30 R30 EL588 - 75W JDR EL317 - 75W PAR30 EL318 - 150W PAR38 EL477 - 150W PAR38
R9H RR9H	ELS30 - 75W PAR or R ELS40 - 75W PAR or R ELA105 - 60W A19 ELA95 - 60W A19 ELA99 - 60W A19	ELM30 - 75W PAR or R ELM304 - 75W PAR30 or R30 ELP30 - 75W PAR or R EL101 - 60W A19 EL304 - 75W PAR30 or R30 EL593 - 50W PAR20 or R20 EL599 - 50W PAR20 or R20	EL17 - 75W PAR or R EL18 - 75W PAR or R EL376 - 75W PAR30 ELM48 - 75W PAR or R ELM38 - 75W PAR or R EL77 - 75W PAR20 or R20 EL377 - 75W PAR or R EL419 - 75W PAR30 EL317 - 75W PAR30
R5H RR5H EL5IC EL5ICA EL5RIC	ELA599 - 60W A19 ELM530 - 75W PAR30 or R30 ELP530 - 75W PAR30 or R30	ELA501 - 60W A19 ELM530 - 75W PAR30 or R30 ELP530 - 75W PAR30 or R30	EL515 - 50W PAR20 EL517 - 75W PAR30 or R30 EL518 - 75W PAR30 or R30 EL519 - 75W PAR30 EL575 - 75W PAR30 EL576 - 75W PAR30 EL577 - 75W PAR30
EL99 EL99R EL99IC EL99ICA	EL999 - 50W PAR20 or R20	EL993 - 50W PAR20 or R20 EL994 - 50W PAR20 or R20 EL995 - 50W PAR20 or R20, 55W PAR16 EL991 - 50W PAR20 or R20	

Lens/ Shower - (Lamps)	Open Trims - (Lamps)	Wall Wash - (Lamps)	Accent Trims - (Lamps)	Line Voltage	
EL642 - 150W PAR or R					Legend: TT=Twin Tube DTT=Double Twin Tube/Quad PL-T=Triple Tube PL-Q=Quadruple Tube
EL832 - 150W A or PAR EL852 - 150W A or PAR					
EL732 - 150W A or PAR EL752 - 150W A or PAR				Legend: TT=Twin Tube DTT=Double Twin Tube/Quad PL-T=Triple Tube PL-Q=Quadruple Tube	
EL25 - 40W A19 EL112 - 40W A19 EL113 - 40W A19 EL116 - 40W A19 ELM45 - 40W A19 EL12 - 25W A19 EL13 - 25W A19 EL16 - 25W A19 ELM42 - 25W A19 ELS42 - 25W A19 ELM43 - 25W A19 ELM46 - 25W A19	EL30 - 75W PAR or R EL40 - 75W PAR or R EL308 - 75W PAR or R EL408 - 75W PAR or R EL79 - 50W PAR or R	ELA105 - 40W A19			
EL25 - 60W A19 EL112 - 60W A19 EL113 - 60W A19 EL116 - 60W A19 ELM45 - 60W A19 EL12 - 40W A19 EL13 - 40W A19 EL16 - 40W A19 ELM42 - 40W A19 ELS42 - 40W A19 ELM43 - 40W A19 ELM46 - 40W A19	EL30 - 75W PAR or R EL40 - 100W PAR or R EL308 - 75W PAR or R EL408 - 100W PAR or R EL79 - 50W PAR or R	ELA105 - 60W A19			
EL25 - 60W A19 EL112 - 75W A19 EL11 - 75W A19 EL116 - 75W A19 ELM45 - 60W A19 EL12 - 60W A19 EL13 - 60W A19 EL16 - 60W A19 ELM42 - 60W A19 ELS42 - 60W A19 ELM43 - 60W A19 ELM46 - 60W A19	EL30 - 75W PAR30 or R30 EL40 - 150W PAR38 or R40 EL308 - 75W PAR or R EL408 - 75W PAR30 or R30 EL79 - 150W PAR38 or R40				
EL25 - 60W A19 EL112 - 75W A19 EL113 - 75W A19 EL116 - 75W A19 ELM45 - 60W A19 EL12 - 60W A19 EL13 - 60W A19 EL16 - 60W A19 ELM42 - 60W A19 ELS42 - 60W A19 ELM43 - 60W A19 ELM46 - 60W A19	EL30 - 75W PAR or R EL40 - 90W PAR38 or R40 EL79 - 75W PAR or R EL308 - 75W PAR30 or R30 EL408 - 90W PAR38 or R40			PL-Q=Quadruple Tube	
EL512 - 60W A19 EL513 - 60W A19 EL514 - 60W A19 EL516 - 60W A19 EL542 - 60W A19 EL546 - 60W A19	EL530 - 75W PAR30 or R30				
EL912 - 30W R20 EL913 - 30W R20 EL916 - 50W R20 EL9112 - 50W R20 EL9113 - 50W R20 EL9116 - 50W R20		EL992 - 30W R20 EL925 - 30W R20 EL990 - 50W PAR20 or R20	EL952 - 50W PAR16 EL953 - 50W PAR16		

Housings	Reflectors - (Lamps)	Baffles - (Lamps)	Adjustable - (Lamps)
EL7LV EL7LV-277 EL7RLV EL7RLV-277 ELH7LV ELH7LV-277	EL2516 - 75W MR16	EL2530 - 75W MR16 EL2566 - 75W MR16	EL2588 - 75W MR16 EL2517 - 75W MR16 EL2521 - 75W MR16 EL2550 - 75W MR16 EL2510 - 75W MR16 EL2511 - 75W MR16 EL2518 - 75W MR16 EL2531 - 75W MR16 EL2576 - 75W MR36 EL2597 - 75W MR16 EL2598 - 75W MR16 EL2575 - 75W MR36
EL7LV50 EL7LV50-277 EL7LVIC EL7LVICA EL7LV50 EL7LV52-277	EL2516 - 50W MR16	EL2530 - 50W MR16 EL2533 - 50W MR16	EL2588 - 50W MR16 EL2517 - 50W MR16 EL2521 - 50W MR16 EL2550 - 50W MR16 EL2510 - 50W MR16 EL2511 - 50W MR16 EL2518 - 50W MR16 EL2531 - 50W MR16 EL2576 - 50W MR36 EL2597 - 50W MR16 EL2598 - 50W MR16 EL2575 - 50W MR36
EL5LV EL5RLV	EL5411 - 75W MR16	EL5493 - 75W MR16 EL5593 - 75W MR16	EL5521 - 75W MR16 EL5420 - 75W MR16 EL5498 - 75W MR16 EL5497 - 75W MR16 EL5488 - 75W MR16 EL5434 - 75W MR16 EL5610 - 75W MR16 EL5611 - 75W MR16 EL5688 - 75W MR16 EL5698 - 75W MR16
EL1499-75 EL1499R-75	EL1421 - 75W MR16 EL1421 - 75W MR16	EL1493 - 75W MR16 EL1494 - 75W MR16 EL1441 - 75W MR16 EL1423 - 75W MR16	EL1420 - 75W MR16 EL1488 - 75W MR16 EL1498 - 75W MR16 EL1497 - 75W MR16 EL1431 - 75W MR16 EL1433 - 75W MR16 EL1429 - 75W MR16
EL1499IC EL1499ICA EL1499 EL1499R EL1499-277 EL1499R-277	EL1421 - 50W MR16 EL1429 - 50W MR16 EL1421 - 50W MR16	EL1493 - 50W MR16 EL1494 - 50W MR16 EL1441 - 50W MR16 EL1423 - 50W MR16	EL1420 - 50W MR16 EL1488 - 50W MR16 EL1498 - 50W MR16 EL1497 - 50W MR16 EL1431 - 50W MR16 EL1433 - 50W MR16 EL1429 - 50W MR16
EL2699 EL2699R	EL2621 - 50W MR16		EL2666 - 50W MR16 EL2677 - 50W MR16 EL2688 - 50W MR16 EL2689 - 50W MR16 EL2697 - 50W MR16 EL2698 - 50W MR16 EL2621 - 50W MR16 EL2693 - 50W MR16
EL27H EL27H-HP EL27H-277 EL27HIC EL27HICA EL27HRIC EL27RH EL27RH-277 EL27RH-HP EL27RHIC EL27RH213IC	ELA99 - 2 PIN 13W TT ELA101- 2 PIN 13W TT	ELA101 - 2 PIN 13W DTT ELM30 - 2 PIN 13W DTT ELM42 - 2 PIN 13W DTT ELM43 - 2 PIN 13W DTT	
EL27H213IC EL27H-213 EL27H-213-H.P.F. EL27H-213-277 EL27RH-213 EL27RH-213-HP EL27RH-213-277	ELA88 - 2 PIN 13W DTT ELA102- 2 PIN 13W DTT	ELA102 - 2 PIN 13W DTT ELM30 - 2 PIN 13W DTT ELM42 - 2 PIN 13W DTT	

Lens/ Shower - (Lamps)	Open Trims - (Lamps)	Wall Wash - (Lamps)	Accent Trims - (Lamps)	Low Voltage Legend: TT=Twin Tube DTT=Double Twin Tube/Quad PL-T=Triple Tube PL-Q=Quadruple Tube
		EL2545 - 50W MR16 EL2525 - 50W MR16	EL2552 - 75W MR16	
		EL2545 - 50W MR16 EL2525 - 50W MR16	EL2552 - 50W MR16	
EL514 - 75W MR16 EL5114 - 75W MR16 EL5412 - 75W MR16			EL5452 - 75W MR16 EL5453 - 75W MR16 EL5552 - 75W MR16 EL5553 - 75W MR16	
EL1411 - 75W MR16 EL1412 - 75W MR16	EL1419 - 50W MR16	EL1495 - 50W MR16 EL1418 - 75W MR16 EL1496 - 75W MR16	EL1442 - 75W MR16 EL1452 - 75W MR16 EL1453 - 75W MR16	
EL1411 - 75W MR16 EL1412 - 75W MR16	EL1419 - 50W MR16	EL1495 - 50W MR16 EL1418 - 50W MR16 EL1496 - 50W MR16	EL1442 - 50W MR16 EL1452 - 50W MR16 EL1453 - 50W MR16	
EL2612 - 50W MR16 EL2613 - 50W MR16 EL2616 - 50W MR16			EL2620 - 50W MR16 EL2633 - 50W MR16 EL2642 - 50W MR16 EL2652 - 50W MR16 EL2619 - 50W MR16 EL2652 - 50W MR16 EL2653 - 50W MR16 EL2660 - 50W MR16	
EL13 - 2 PIN 13W DTT EL112 - 2 PIN 13W DTT EL113 - 2 PIN 13W DTT EL12 - 2 PIN 13W DTT EL16 - 2 PIN 13W DTT ELM42 - 2 PIN 13W DTT ELM46 - 2 PIN 13W DTT ELS42 - 2 PIN 13W DTT ELM43 - 2 PIN 13W DTT EL116 - 2 PIN 13W DTT		ELA105 - 2 PIN 13W DTT ELA95 - 2 PIN 13W DTT		
EL13 - 2 PIN 13W DTT EL112 - 2 PIN 13W DTT EL113 - 2 PIN 13W DTT EL12 - 2 PIN 13W DTT EL16 - 2 PIN 13W DTT ELM42 - 2 PIN 13W DTT ELM46 - 2 PIN 13W DTT ELS42 - 2 PIN 13W DTT ELM43 - 2 PIN 13W DTT EL116 - 2 PIN 13W DTT		ELA205 - 2 PIN 13W DTT ELA85 - 2 PIN 13W DTT		

Housings	Reflectors - (Lamps)	Baffles - (Lamps)	Adjustable - (Lamps)	
EL27H EL27H-HP EL27H-277 EL27HIC EL27HICA EL27HRIC EL27RH EL27RH-277 EL27RH-HP EL27RHIC EL27RH213C	ELA99 - 2 PIN 13W TT ELA101 - 2 PIN 13W TT			
EL27H213C EL27H-213 EL27H-213-H.P.F. EL27H-213-277 EL27RH-213 EL27RH-213-HP EL27RH-213-277	ELA88 - 2 PIN 13W DTT ELA102 - 2 PIN 13W DTT			
EL27H18 EL27RH18	ELA99 - 2 PIN18W DTT ELA101 - 2 PIN 18W DTT	ELA101 - 2 PIN 18W DTT ELM30 - 2 PIN 18W DTT ELM42 - 2 PIN 18W DTT		
EL27HE EL27RHE13	ELA99 - 4 PIN 13W DTT or PL-T ELA101 - 4 PIN 13W DTT or PL-T	ELA101 - 4 PIN 13W DTT or PL-T ELM30 - 4 PIN 13W DTT or PL-T ELM42 - 4 PIN 13W PL-T ELM43 - 4 PIN 13W PL-T		
EL27HE18 EL27H18D EL27RHE18	ELA99 - 4 PIN 18W DTT or PL-T ELA101 - 4 PIN 18W DTT or PL-T	ELA101 - 4 PIN 18W DTT or PL-T ELM30 - 4 PIN 18W DTT or PL-T ELM42 - 4 PIN 18W PL-T ELM43 - 4 PIN 18W PL-T		
EL27HE26 EL27RHE26 EL27H26D EL27RH26D	ELA99 - 4 PIN 26W DTT or PL-T ELA101 - 4 PIN 26W DTT or PL-T	ELA101 - 4 PIN 26W DTT or PL-T ELM30 - 4 PIN 26W DTT or PL-T ELM42 - 4 PIN 26W PL-T ELM43 - 4 PIN 26W PL-T		
EL27HE32 EL27RHE32 EL27H32D EL27RH32D	ELA99 - 4 PIN 32W PL-T ELA101 - 4 PIN 32W PL-T	ELA101 - 4 PIN 32W PL-T ELM30 - 4 PIN 32W PL-T ELM42 - 4 PIN 32W PL-T ELM43 - 4 PIN 32W PL-T		
EL27HE42 EL27H42D EL27RHE42 EL27RH42D	ELA99 - 4 PIN 42W PL-T or PL-T ELA101 - 4 PIN 42W PL-T or PL-T	ELA101 - 4 PIN 42W PL-T, PL-Q ELM30 - 4 PIN 42W PL-T, PL-Q ELM42 - 4 PIN 42W PL-T, PL-Q ELM43 - 4 PIN 42W PL-T, PL-Q		
EL27H213E EL27H213D EL27RHE-213 EL27RHD-213	ELA88 - 4 PIN 13W DTT ELA102 - 4 PIN 13W DTT	ELA102 - 4 PIN 13W DTT ELM30 - 4 PIN 13W DTT ELM42 - 4 PIN 13W DTT		

Lens/ Shower - (Lamps)	Open Trims - (Lamps)	Wall Wash - (Lamps)	Accent Trims - (Lamps)
EL13 - 2 PIN 13W DTT EL112 - 2 PIN 13W DTT EL113 - 2 PIN 13W DTT EL12 - 2 PIN 13W DTT EL16 - 2 PIN 13W DTT ELM42 - 2 PIN 13W DTT ELM46 - 2 PIN 13W DTT ELS42 - 2 PIN 13W DTT ELM43 - 2 PIN 13W DTT EL116 - 2 PIN 13W DTT		ELA105 - 2 PIN 13W DTT ELA95 - 2 PIN 13W DTT	
EL13 - 2 PIN 13W DTT EL112 - 2 PIN 13W DTT EL113 - 2 PIN 13W DTT EL12 - 2 PIN 13W DTT EL16 - 2 PIN 13W DTT ELM42 - 2 PIN 13W DTT ELM46 - 2 PIN 13W DTT ELS42 - 2 PIN 13W DTT ELM43 - 2 PIN 13W DTT EL116 - 2 PIN 13W DTT		ELA205 - 2 PIN 13W DTT ELA95 - 2 PIN 13W DTT	
EL12 - 2 PIN 18W DTT EL13 - 2 PIN 18W DTT EL16 - 2 PIN 18W DTT EL112 - 2 PIN 18W DTT EL113 - 2 PIN 18W DTT EL116 - 2 PIN 18W DTT ELM42 - 2 PIN 18W DTT ELM43 - 2 PIN 18W DTT ELM46 - 2 PIN 18W DTT ELS42 - 2 PIN 18W DTT		ELA95 - 2 PIN 18W PL-T ELA105 - 2 PIN 18W PL-T	
EL12 - 4 PIN 13W DTT or PL-T EL13 - 4 PIN 13W DTT or PL-T EL16 - 4 PIN 13W DTT or PL-T EL112 - 4 PIN 13W DTT or PL-T EL113 - 4 PIN 13W DTT or PL-T EL116 - 4 PIN 13W DTT or PL-T ELM42 - 4 PIN 13W DTT ELM43 - 4 PIN 13W DTT ELM46 - 4 PIN 13W DTT ELS42 - 4 PIN 13W DTT		ELA95 - 4 PIN 13W PL-T ELA105 - 4 PIN 13W PL-T	
EL12 - 4 PIN 18W DTT or PL-T EL13 - 4 PIN 18W DTT or PL-T EL16 - 4 PIN 18W DTT or PL-T EL112 - 4 PIN 18W DTT or PL-T EL113 - 4 PIN 18W DTT or PL-T EL116 - 4 PIN 18W DTT or PL-T ELM42 - 4 PIN 18W DTT or PL-T ELM43 - 4 PIN 18W PL-T ELM46 - 4 PIN 18W PL-T ELS42 - 4 PIN 18W PL-T		ELA95 - 4 PIN 18W PL-T ELA105 - 4 PIN 18W PL-T	
EL12 - 4 PIN 26W PL-T EL13 - 4 PIN 26W PL-T EL16 - 4 PIN 26W PL-T EL112 - 4 PIN 26W PL-T EL113 - 4 PIN 26W PL-T EL116 - 4 PIN 26W PL-T ELM42 - 4 PIN 26W PL-T ELM43 - 4 PIN 26W PL-T ELM46 - 4 PIN 26W PL-T ELS42 - 4 PIN 26W PL-T		ELA95 - 4 PIN 26W PL-T ELA105 - 4 PIN 26W PL-T	
EL12 - 4 PIN 32W PL-T EL13 - 4 PIN 32W PL-T EL16 - 4 PIN 32W PL-T EL112 - 4 PIN 32W PL-T EL113 - 4 PIN 32W PL-T EL116 - 4 PIN 32W PL-T ELM42 - 4 PIN 32W PL-T ELM43 - 4 PIN 32W PL-T ELM46 - 4 PIN 32W PL-T ELS42 - 4 PIN 32W PL-T		ELA95 - 4 PIN 32W PL-T ELA105 - 4 PIN 32W PL-T	
EL12 - 4 PIN 42W PL-T, PL-Q EL13 - 4 PIN 42W PL-T, PL-Q EL16 - 4 PIN 42W PL-T, PL-Q EL112 - 4 PIN 42W PL-T, PL-Q EL113 - 4 PIN 42W PL-T, PL-Q EL116 - 4 PIN 42W PL-T, PL-Q ELM42 - 4 PIN 42W PL-T, PL-Q ELM43 - 4 PIN 42W PL-T, PL-Q ELM46 - 4 PIN 42W PL-T, PL-Q ELS42 - 4 PIN 42W PL-T, PL-Q		ELA95 - 4 PIN 42W PL-T ELA105 - 4 PIN 42W PL-T	
EL12 - 4 PIN 26W PL-T EL13 - 4 PIN 26W PL-T EL16 - 4 PIN 26W PL-T EL112 - 4 PIN 26W PL-T EL113 - 4 PIN 26W PL-T EL116 - 4 PIN 26W PL-T ELM42 - 4 PIN 26W PL-T ELM43 - 4 PIN 26W PL-T ELM46 - 4 PIN 26W PL-T ELS42 - 4 PIN 26W PL-T		ELA85 - 4 PIN 26W PL-T ELA205 - 4 PIN 26W PL-T	
EL12 - 4 PIN 32W DTT EL13 - 4 PIN 32W DTT EL16 - 4 PIN 32W DTT EL112 - 4 PIN 32W DTT			

Housings	Reflectors - (Lamps)	Baffles - (Lamps)	Adjustable - (Lamps)	
EL527H EL527HIC EL527-HP EL527H-277	ELA501 - 2 PIN 13W DTT ELA599 - 2 PIN 13W DTT	ELA501 - 2 PIN 13W DTT ELM530 - 2 PIN 13W DTT		
EL527HE13	ELA501 - 4 PIN 13W DTT or PL-T ELA599 - 4 PIN 13W DTT or PL-T	ELA501 - 2 PIN 13W DTT or PL-T ELM530 - 2 PIN 13W DTT or PL-T		
EL527HE18 EL527H18D	ELA501 - 4 PIN 18W PL-T ELA599 - 4 PIN 18W PL-T	ELA501 - 4 PIN 18W PL-T ELM530 - 4 PIN 18W PL-T		
EL527HE42 EL527H42D	ELA599 - 4 PIN 42/32/26W PL-T ELA501 - 4 PIN 42/32/26W PL-T	ELA501 - 4 PIN 42/32/26W PL-T ELM530 - 4 PIN 42/32/26W PL-T		
EL99PL EL99PL-HP EL99PL-277	EL999 - 2 PIN 13W DTT	EL993 - 2 PIN 13W DTT		
EL99PLE	EL999 - 4 PIN 13W PL-T	EL993 - 2 PIN 13W PL-T		

Lens/ Shower - (Lamps)	Open Trims - (Lamps)	Wall Wash - (Lamps)	Accent Trims - (Lamps)
EL512 - 2 PIN 13W DTT EL513 - 2 PIN 13W DTT EL516 - 2 PIN 13W DTT EL542 - 2 PIN 13W DTT EL546 - 2 PIN 13W DTT ELS542 - 2 PIN 13W DTT			
EL512 - 4 PIN 13W DTT or PL-T EL513 - 4 PIN 13W DTT or PL-T EL516 - 4 PIN 13W DTT or PL-T EL542 - 4 PIN 13W DTT or PL-T EL546 - 4 PIN 13W DTT or PL-T ELS542 - 4 PIN 13W DTT or PL-T			
EL512 - 4 PIN 18W PL-T EL513 - 4 PIN 18W PL-T EL516 - 4 PIN 18W PL-T EL542 - 4 PIN 18W PL-T EL546 - 4 PIN 18W PL-T ELS542 - 4 PIN 18W PL-T EL512 - 4 PIN 18W PL-T EL513 - 4 PIN 18W PL-T EL516 - 4 PIN 18W PL-T EL542 - 4 PIN 18W PL-T			
EL512 - 4 PIN 42/32/26W PL-T EL513 - 4 PIN 42/32/26W PL-T EL516 - 4 PIN 42/32/26W PL-T EL542 - 4 PIN 42/32/26W PL-T EL546 - 4 PIN 42/32/26W PL-T ELS542 - 4 PIN 42/32/26W PL-T		EL992 - 2 PIN 13W DTT	
EL9112 - 2 PIN 13W DTT EL9116 - 2 PIN 13W DTT EL912 - 2 PIN 13W DTT EL913 - 2 PIN 13W DTT EL916 - 2 PIN 13W DTT		EL992 - 4 PIN 13W PL-T	
EL9112 - 4 PIN 13W PL-T EL9116 - 4 PIN 13W PL-T EL912 - 4 PIN 13W PL-T EL913 - 4 PIN 13W PL-T EL916 - 4 PIN 13W PL-T			

Sloped Downlight Photometrics

Line Voltage

Cat. No.	Distance	Lamp -75W,PAR30, Spot			Lamp -75W, PAR30, Flood		
EL601 & EL624	In	Beam	Beam FC	Beam FC	Beam	Beam FC	BeamFC
Beam 16° Beam 36°	Feet	Diameter	Center	Edge	Diameter	Center	Edge
	8	2.2	141.8	69.2	5.1	43.2	18.5
	10	2.7	90.8	44.1	6.4	27.7	11.8
	12	3.0	63.1	30.6	7.7	19.3	8.2
	14	3.8	46.4	22.4	9.0	14.2	6.3
	16	4.3	35.5	17.2	10.3	10.9	4.6

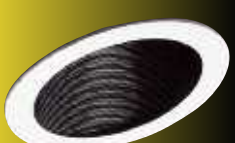
Cat. No.	Distance	Lamp -90W, PAR38, Spot			Lamp -75W, PAR30, Flood		
EL622,EL623 & EL626	In	Beam	Beam FC	BeamFC	Beam	Beam FC	Beam FC
Beam 19° Beam 34°	Feet	Diameter	Center	Edge	Diameter	Center	Edge
	8	2.6	158.9	76.4	4.9	56.2	24.2
	10	3.2	101.7	48.9	5.9	36.0	15.5
	12	4.0	70.6	34.0	7.9	25.0	10.7
	14	4.5	52.0	24.9	8.9	18.4	7.8
	16	5.1	39.8	19.0	9.9	14.1	6.0

Cat. No.	Distance	Lamp - 75W, R30, Spot			Lamp -75W, PAR30, Flood		
ELM38	In	Beam	Beam FC	Beam FC	Beam	Beam FC	Beam FC
Beam 25° Beam 82°	Feet	Diameter	Center	Edge	Diameter	Center	Edge
	4	2.0	108.1	42.8	6.7	26.1	5.6
	6	2.9	51.4	23.7	10.15	11.7	2.4
	8	3.6	28.9	13.3	13.6	6.6	1.3
	10	4.5	18.6	8.5	17.2	4.3	.8
	12	5.4	12.9	5.9	20.6	3.0	.5

Cat. No.	Distance	Lamp - 55W, PAR16, NSP			Lamp - 55W, PAR16, NF		
EL610	In	Beam	Beam FC	Beam FC	Beam	Beam FC	Beam FC
Beam 16° Beam 27°	Feet	Diameter	Center	Edge	Diameter	Center	Edge
	4	1.1	318.1	154.9	3.8	94.1	36.8
	6	1.6	141.1	68.9	5.8	42.1	16.3
	8	2.1	80.1	39.0	7.7	23.1	9.3
	10	2.6	51.0	24.8	9.7	12.9	5.8
	12	3.1	35.4	17.2	11.6	8.7	4.0

Low Voltage

Cat. No.	Distance	EXT Lamp-50W MR16 NSP			EXN Lamp-50 MR16 Flood		
EL1610	In	Beam	Beam FC	Beam FC	Beam	Beam FC	Beam FC
Beam 11° Beam 37°	Feet	Diameter	Center	Edge	Diameter	Center	Edge
	4	0.9	572.1	285.1	2.6	94.1	41.3
	6	1.4	254.1	127.1	4.0	42.1	18.3
	8	1.7	143.9	71.1	5.4	23.1	10.2
	10	2.2	92.1	46.1	6.8	15.1	6.5
	12	2.6	63.9	32.1	8.1	10.1	4.5

R10H - ELA99SC - 100W - A19

Distance to Plane	Initial Nadir Footcandles	Beam Diameter
5'0"	22.4	4'6"
7'0"	10.7	6'6"
9'6"	6.2	8'6"
11'6"	4.1	10'6"
14'0"	2.9	12'6"
16'0"	2.2	14'6"

R10H - ELS40C - 150W - A21

Distance to Plane	Initial Nadir Footcandles	Beam Diameter
9'0"	31.9	4'6"
13'0"	15.4	6'6"
17'6"	9.0	8'6"
21'0"	5.9	10'6"
25'6"	4.0	12'6"
29'0"	3.3	14'6"

R10H - ELS30C - 150W - R40 SP

Distance to Plane	Initial Nadir Footcandles	Beam Diameter
2'0"	286.9	4'6"
2'6"	137.5	6'6"
3'0"	80.5	8'6"
4'0"	82.8	10'6"
5'0"	37.3	12'6"
5'6"	27.8	14'6"

R10H - ELM30 - 75W - R30

Distance to Plane	Initial Nadir Footcandles	Beam Diameter
4'6"	20.0	4'6"
6'6"	9.8	6'6"
8'6"	5.8	8'6"
10'6"	3.8	10'6"
12'6"	2.7	12'6"
14'6"	2.0	14'6"

R10H - ELM40 - 150W - R40- SP

Distance to Plane	Initial Nadir Footcandles	Beam Diameter
2'0"	270.6	4'6"
2'6"	129.8	6'6"
3'0"	75.9	8'6"
4'0"	49.9	10'6"
5'0"	35.0	12'6"
5'6"	26.0	14'6"

R10H - ELM40 - 150W - R40

Distance to Plane	Initial Nadir Footcandles	Beam Diameter
4'0"	58.0	4'6"
6'0"	28.0	6'6"
7'6"	16.3	8'6"
9'0"	10.8	10'6"
11'0"	7.6	12'6"
13'0"	5.7	14'6"

R10H - EL12 - 60W - A19

Distance to Plane	Initial Nadir Footcandles	Beam Diameter
5'0"	4.0	4'6"
8'0"	2.0	6'6"
10'6"	1.2	8'6"
13'0"	0.8	10'6"
15'6"	0.6	12'6"
18'0"	0.5	14'6"

R10H - ELA99SC - 150W - A19

Distance to Plane	Initial Nadir Footcandles	Beam Diameter
4'6"	50.3	4'6"
6'6"	24.0	6'6"
8'6"	14.0	8'6"
10'6"	9.4	10'6"
12'6"	6.6	12'6"
14'0"	5.0	14'6"

R10H - EL40 - 150W - R40 - SP

Distance to Plane	Initial Nadir Footcandles	Beam Diameter
2'0"	270.5	4'6"
2'6"	129.8	6'6"
3'0"	75.9	8'6"
4'0"	49.7	10'6"
5'0"	35.0	12'6"
5'6"	26.0	14'6"

R10H - EL30 - 75W - R30 - SP

Distance to Plane	Initial Nadir Footcandles	Beam Diameter
2'0"	74.4	4'6"
3'0"	36.0	6'6"
4'0"	21.0	8'6"
5'0"	13.8	10'6"
6'0"	9.8	12'6"
7'0"	7.3	14'6"

ELH8226 - EL821C - (2) 26W - DTT

Distance to Plane	Initial Nadir Footcandles	Beam Diameter
6'0"	42.9	4'6"
9'0"	20.9	6'6"
12'0"	12.5	8'6"
15'0"	8.2	10'6"
17'6"	5.8	12'6"
20'0"	4.3	14'6"

ELH8226 - EL830 - (2) 26W - DTT

Distance to Plane	Initial Nadir Footcandles	Beam Diameter
6'0"	36.5	4'6"
9'0"	17.5	6'6"
12'0"	10.4	8'6"
15'0"	6.9	10'6"
17'6"	4.9	12'6"
20'0"	3.1	14'6"

EL27H213 - EL88SC - (2) 13W - DTFIT

Distance to Plane	Initial Nadir Footcandles	Beam Diameter
3'6"	12.9	4'6"
5'0"	18.2	6'6"
7'0"	10.4	8'6"
8'6"	6.9	10'6"
10'0"	4.9	12'6"
20'0"	3.6	14'6"

ELH213 or ELH7213 - EL721 - (2) 13W - DTFIT

Distance to Plane	Initial Nadir Footcandles	Beam Diameter
3'6"	28.7	4'6"
5'0"	16.8	6'6"
7'0"	9.7	8'6"
8'6"	6.7	10'6"
10'0"	5.9	12'6"
20'0"	4.6	14'6"

Index

CH26	241	E233C	191	EDU2LV	195
CLIP-1	242	E233CP	191	EDU2RD	195
CLIP-2	242	E233G	191	EDU3	195
CLIP-4	242	E233N	191	EE20L	218
CLIP721	242	E233W	191	EE20LB	218
CLIP-R	242	E234B	191	EE21RW	215
DISP-D2	248, 249	E234G	191	EE22GW	215
DISP-D3	248	E234N	191	EE40L	218
DISP-D4	248, 249	E234W	191	EE50L	218
DISP-D5	248	E300	191	EE70L	218
DISP-D6	248, 249	E326B	193	EE71RD	215
DISP-D7	248	E326C	193	EE72GD	215
DISP-DT	248	E326G	193	EE73RD	215
DISP-F2	248	E326W	193	EE74GD	215
DISP-F3	248	E400	80	EE80S	216
DISP-F4	248	E450	80	EE81S	216
DISP-F5	248	E4M20E	178	EE83HR	216
DISP-F6	248	E4M35E	178	EE84HG	216
DISP-F7	248	E6M100	172	EE87HR	216
DISP-FT	248	E6M100E	173	EE88HG	216
E10M100	168	E6M32	172	EE97HR	217
E10M100E	168	E6M32E	173	EE98HG	217
E10M150	168	E6M50	172	EELE1	215
E10M150E	168	E6M50E	173	EELE1B	215
E10M175	168	E6M70	172	EELE2	215
E10M250E	168	E6M70E	173	EELE3	215
E10M70	168	E6S100	174	EELE5	215
E10M70E	168	E6S32	174	EELE6	215
E10S100	168	E6S50	174	EELED	215
E10S150	168	E6S70	174	EELEDB	215
E10S250	168	E8M100	169	EEP3A	219
E10S70	168	E8M100E	170	EEP4A	219
E200	190	E8M150	169	EEP8A	219
E221B	190	E8M150E	170	EEPS66	219
E221G	190	E8M32	169	EERH15	218
E221N	190	E8M32E	170	EERT5R	219
E221W	190	E8M50	169	EERT5R-H	219
E222B	190	E8M50E	170	EERT6G	219
E222BZ	190	E8M70	169	EERT6G-H	219
E222C	190	E8M70E	170	EEWG11	219
E222CP	190	E8S100	171	EEWG22	219
E222G	190	E8S150	171	EL1016C	148, 168
E222N	190	E8S50	171	EL1037C	148, 168
E222W	190	E8S70	171	EL10W	28, 110
E225B	192	EBA12E	194	EL112BZ	16, 126
E225N	192	EBA21E	194	EL112CP	16, 126
E225R	192	EBA26E	194	EL112G	16, 126
E225W	192	EBA42E	194	EL112SH	16, 126
E226B	192	ECN2	195	EL112W	16, 126
E226BS	192	ECN3	195	EL113BZ	16, 126
E226C	192	ECN5	195	EL113CP	16, 126
E226G	192	EDGLIT1G	217	EL113G	16, 126
E226GS	192	EDGLIT1R	217	EL113SH	16, 126
E226W	192	EDGLIT2G	217	EL113W	16, 126
E226WS	192	EDGLIT2R	217	EL114SH	16
E228B	193	EDGREC1G	217	EL116BZ	16, 126
E228BS	193	EDGREC1R	217	EL116CP	16, 126
E228BZ	193	EDGREC2G	217	EL116G	16, 126
E228C	193	EDGREC2R	217	EL116SH	16, 126
E228CP	193	EDSC-3	188	EL116W	16, 126
E228G	193	EDSC-4	189	EL11W	28, 110
E228GS	193	EDSC-4L	189	EL122SH	16, 126
E228N	193	EDSC-4L-24	189	EL122W	16, 126
E228NS	193	EDU2	195	EL1299	52
E228W	193	EDU2BL	195	EL1299R	52
E228WS	193	EDU2FR	195	EL12BZ	15, 130, 131
E233B	191	EDU2GR	195	EL12CP	15, 26, 130, 131
E233BZ	191	EDU2LED	195	EL12G	15, 233

Index

EL12KSH	15	EL1423BZ	88	EL1493BN	82
EL12N	15, 233	EL1423CP	88	EL1493BZ	77, 82, 180
EL12SH	15, 26, 126, 129, 130, 131, 234	EL1423W	77, 88	EL1493CP	82
EL12W	15, 26, 126, 129, 130, 131, 233	EL1423WCP	88	EL1493DB	82
EL13BZ	15, 130, 131	EL1423WN	88	EL1493DW	82
EL13CP	15, 26, 130, 131	EL1424B	84	EL1493MB	82
EL13G	15, 233	EL1424BZ	84	EL1493MW	82
EL13KSH	15	EL1424CP	84	EL1493N	82
EL13N	15, 233	EL1424N	84	EL1493W	82
EL13SH	15, 26, 126, 129, 130, 131, 234	EL1424W	84	EL1493WBZ	82
EL13W	26, 15, 126, 129, 130, 131, 233	EL1425B	84, 89	EL1493WN	82
EL1411BZ	81	EL1425N	84	EL1494B	82
EL1411C	81	EL1425W	84, 89	EL1494BG	82
EL1411CP	81	EL1425WN	84	EL1494BN	82
EL1411N	81	EL1426B	85	EL1494W	82
EL1411SH	81	EL1426BZ	85	EL1494WN	82
EL1411W	81	EL1426C	85	EL1495B	86
EL1412B	81	EL1426CP	85	EL1495W	86
EL1412BZ	81	EL1426G	85	EL1496W	86
EL1412C	81	EL1426N	85	EL1497B	86
EL1412CP	81	EL1426W	85	EL1497BZ	86
EL1412N	81	EL1429B	88, 180	EL1497CP	86
EL1412SH	81	EL1429BCP	77, 88	EL1497G	87
EL1412W	81	EL1429BN	180	EL1497N	87, 89
EL1415B	81	EL1429C	88, 180	EL1497W	87, 89
EL1415BZ	81	EL1429CN	180	EL1498B	87
EL1415C	81	EL1429G	88, 180	EL1498BB	89
EL1415CP	81	EL1429N	88	EL1498G	77, 87
EL1415G	81	EL1429W	88	EL1498W	87, 89
EL1415N	81	EL1430N	88	EL1498WW	77, 87, 89
EL1415SH	81	EL1430W	88	EL1499	76, 78
EL1415W	81	EL1431B	85	EL1499-277	78
EL1416W	75, 81	EL1431BBG	85	EL1499-277-EM	236
EL1418W	83	EL1431W	85	EL1499-75	79
EL1419B	83	EL1433B	85, 180	EL1499-75-277	79
EL1419W	83	EL1433W	85, 180	EL1499A	78
EL1420B	83	EL1434WB	85	EL1499A-75	79
EL1420BZ	83	EL1434WW	85	EL1499A-EM	236
EL1420CP	83	EL1441W	85	EL1499EA	78
EL1420G	77, 83	EL1442G	77, 88	EL1499-EM	236
EL1420N	83	EL1442W	88	EL1499IC	78
EL1420W	77, 83	EL1445B	85	EL1499ICA	75, 78
EL1421B	83, 89	EL1445C	85	EL1499ICA-277	78
EL1421BN	83	EL1445G	85	EL1499ICAS	78
EL1421BZ	83	EL1445W	85	EL1499ICEA	78
EL1421C	83, 89, 180	EL1448B	85, 89	EL1499R	79
EL1421CC	83	EL1448BG	86	EL1499R-277	79
EL1421CCP	83	EL1448G	89	EL1499R-75	79
EL1421CN	83, 180	EL1448W	85, 89	EL1499R75-27	79
EL1421CP	83, 180	EL1452BL	88	EL1499RA	79
EL1421DC	84	EL1452R	77, 88	EL1499RA-75	79
EL1421DG	84	EL1452W	88	EL1499REA	79
EL1421G	83, 89, 180	EL1453BL	41, 88	EL1499RS	80
EL1421GBZ	83	EL1453W	88	EL1499S	80
EL1421GCP	83	EL1487B	86	EL1510B	64
EL1421GG	83	EL1487G	86	EL1510BZ	64
EL1421GN	83	EL1487N	86	EL1510CP	64
EL1421W	83, 89, 180	EL1487W	86	EL1510N	64
EL1421WBZ	83	EL1488B	86, 89, 180	EL1510W	64
EL1421WCP	84	EL1488BZ	86, 180	EL1511B	64
EL1421WN	83	EL1488CP	86, 180	EL1511C	64
EL1422B	84, 180	EL1488G	86, 89	EL1511G	64
EL1422BZ	84	EL1488N	86, 89, 180	EL1511W	64
EL1422C	84, 180	EL1488SB	86	EL1512B	64
EL1422CP	84, 180	EL1488SW	86	EL1512W	64
EL1422W	84, 180	EL1488W	75, 86, 89, 180	EL1516B	64
EL1423B	88	EL1493B	82	EL1516C	64
EL1423BN	88	EL1493BB	82	EL1516G	64
		EL1493BBZ	82	EL1516W	64
		EL1493BC	82	EL1518B	65
		EL1493BCP	82	EL1518W	65
		EL1493BG	77, 82	EL1521B	64

Index

EL1521C	64	EL2421WBZ	87	EL2597B	63, 163
EL1521G	64	EL2440B	87	EL2597BZ	63, 163
EL1521W	64	EL2440BZ	87	EL2597CP	63, 163
EL1530B	64	EL2440W	87	EL2597N	63, 163
EL1530W	64	EL2493B	87	EL2597W	63, 163
EL1531B	65	EL2493BB	87	EL25W	22
EL1531W	65	EL2493BBZ	87	EL2612W	55, 94
EL1533B	65	EL2493BZ	87	EL2613W	55, 94
EL1533W	65	EL2493W	87	EL2616B	55, 94
EL1550W	65	EL2493WBZ	87	EL2616C	55, 94
EL1552BL	64	EL2510B	61	EL2616G	55, 94
EL1552R	64	EL2510BZ	61	EL2616W	55, 94
EL1552W	64	EL2510CP	61	EL2619WB	55, 94
EL1553BL	64	EL2510N	61	EL2619WC	55, 94
EL1553W	64	EL2510W	61	EL2620W	55, 94
EL1568B	65	EL2511B	61, 163	EL2621B	56, 92
EL1568W	65	EL2511C	61, 163	EL2621BB	56, 92
EL1575B	65	EL2511G	61, 163	EL2621BBZ	92
EL1575N	65	EL2511W	61, 163	EL2621BZ	56, 92
EL1575W	65	EL2512B	61	EL2621C	56, 92
EL1576B	65	EL2512W	61	EL2621CC	56, 92
EL1576C	65	EL2516B	163	EL2621CN	56, 92
EL1576G	65	EL2516C	61, 163	EL2621CP	56, 92
EL1576W	65	EL2516G	61, 163	EL2621G	56, 92
EL1579W	65	EL2516W	61, 163	EL2621GG	56, 92
EL1587B	65	EL2517W	61, 163	EL2621GN	56, 92
EL1587W	65	EL2517WW	61	EL2621W	56, 92
EL1588B	65	EL2518B	61	EL2622B	56, 92
EL1588W	65	EL2518W	61	EL2622C	56, 92
EL1589W	65	EL2521B	61, 163	EL2622CP	56, 92
EL1597B	65	EL2521C	61, 163	EL2622G	56, 92
EL1597BZ	65	EL2521G	61, 163	EL2622N	56, 92
EL1597CP	65	EL2521W	61, 163	EL2622W	56, 92
EL1597W	65	EL2525B	61	EL2624B	56, 92
EL15W	28, 110	EL2525W	61	EL2624CP	56, 92
EL1610B	66	EL2529B	61, 163	EL2624N	56, 92
EL1610W	66	EL2529W	61, 163	EL2624W	56, 92
EL1611B	66	EL2530B	62, 163	EL2633B	56, 94
EL1611C	66	EL2530W	62, 163	EL2633W	56, 94
EL1611G	66	EL2531B	62	EL2644B	56, 92
EL1611W	66	EL2531W	62	EL2644C	56, 92
EL1612B	66	EL2533B	62	EL2644G	56, 92
EL1612W	66	EL2533BBZ	62	EL2644W	56, 92
EL1621B	66	EL2533BCP	62	EL2652BL	55, 94
EL1621W	66	EL2533BZ	62	EL2652W	55, 95
EL1675B	66	EL2533CP	62	EL2653BL	55, 95
EL1675W	66	EL2533W	62	EL2653W	55, 95
EL16BZ	16, 126	EL2545B	62	EL2660B	55, 95
EL16CP	16, 126	EL2545W	62	EL2660C	55, 95
EL16G	16	EL2550B	163	EL2660W	55, 95
EL16KSH	16	EL2550W	62, 163	EL2666B	92, 95
EL16SH	16, 126, 129	EL2552BL	63	EL2666C	92, 95
EL16W	16, 126, 129	EL2552R	63	EL2666G	92, 95
EL17B	20	EL2552W	63	EL2666W	92, 95
EL17W	20	EL2553BL	63	EL2677B	92, 95
EL18B	20	EL2553W	63	EL2677C	92, 95
EL18BZ	20	EL2568B	62	EL2677G	92, 95
EL18CP	20	EL2568W	62, 163	EL2677W	92, 95
EL18G	20	EL2575B	62	EL2688B	57, 93, 95
EL18N	20	EL2575N	62	EL2688BZ	57, 93, 95
EL18W	20	EL2575W	62	EL2688C	57, 93, 95
EL22SH	16, 126	EL2576B	62, 163	EL2688CP	57, 93, 95
EL22W	16, 126	EL2576C	62, 163	EL2688G	93, 95
EL2412BZ	87	EL2576G	62, 163	EL2688N	57, 92, 95
EL2412W	87	EL2576W	62, 163	EL2688W	57, 93, 95
EL2415BZ	87	EL2579B	62	EL2689BB	57, 93, 95
EL2415W	87	EL2579W	62	EL2689W	93
EL2421B	87	EL2587B	62	EL2689WB	57, 93, 95
EL2421BZ	87	EL2587W	62	EL2689WW	57, 93, 95
EL2421C	87	EL2588B	63	EL2693B	57, 93
EL2421G	87	EL2588W	63	EL2693BB	57, 93
EL2421W	87	EL2589W	63	EL2693BN	57, 93

Index

EL2693BZ	57, 93	EL27R26ICD1A	125	EL317W	20, 176
EL2693CP	57, 93	EL27RH13ICDA	125	EL318G	20, 176
EL2693N	57, 93	EL27RH18D	124	EL318N	20
EL2693W	57, 93	EL27RH18DX	124	EL318W	20, 176
EL2693WBZ	93	EL27RH18DX-7	124	EL319W	17, 127
EL2693WCP	57, 93	EL27RH18ICDA	125	EL376B	21
EL2693WN	57, 93	EL27RH213D	128	EL376BZ	17
EL2695W	57, 93	EL27RH213E	128	EL376CP	17
EL2696W	93	EL27RH-213ICA	128	EL376N	21
EL2697B	94, 95	EL27RH26D	124	EL376W	21
EL2697BZ	94	EL27RH26DX	124	EL377B	21
EL2697CP	93	EL27RH26DX-7	124	EL377B-RM7W	176
EL2697N	94	EL27RH26ICDA	125	EL377C	21
EL2697W	94, 95	EL27RH26ICDXA	125	EL377C-RM7W	176
EL2698WB	57, 94, 95	EL27RH32D	124	EL377G	21
EL2698WW	57, 94, 95	EL27RH32DX	124	EL377G-RM7W	176
EL2699	90	EL27RH32DX-7	124	EL377W	21
EL2699-277	90	EL27RH42D	124	EL377WRM7W	176
EL2699-75	90	EL27RH42DX	124	EL39A	54
EL2699A	90	EL27RH42DX-7	124	EL39ICA	54
EL2699A-EM	236	EL27RHE13	124	EL39RA	54
EL2699-EM	236	EL27RHE13IC	125	EL408W	19
EL2699ICA	90	EL27RHE13ICA	125	EL40BZ	19
EL2699R	90	EL27RHE18	124	EL40C	13, 19
EL2699RA	90	EL27RHE18IC	125	EL40CP	19
EL2699RS	91	EL27RHE18ICA	125	EL40G	13, 19
EL2699S	91	EL27RHE26	124	EL40N	13, 19
EL27H13D	121	EL27RHE26IC	125	EL40W	13, 19
EL27H13ICDA	122	EL27RHE26ICA	125	EL419BB	21
EL27H18D	121	EL27RHE32	124	EL419BW	21
EL27H18DX	121	EL27RHE42	124	EL419CG	21
EL27H18ICD1A	122	EL27RHICA	125	EL419CN	21
EL27H18ICDA	122	EL29112B	47	EL419CW	21
EL27H213D	128	EL29112BZ	47	EL419GG	21
EL27H213E	128	EL29112W	47	EL419GW	21
EL27H213ICA	128	EL29115BZ	47	EL419WW	21
EL27H26D	121	EL29115W	47	EL476B	21
EL27H26DX	121	EL2912 BZ	47	EL476W	21
EL27H26DX-7	121	EL2912W	47	EL477B	21
EL27H26ICD1A	122	EL2915 BZ	47	EL477B-RM7W	176
EL27H26ICDA	122	EL2915W	47	EL477C	21
EL27H26ICDXA	122	EL2993B	47	EL477C-RM7W	176
EL27H32D	121	EL2993BB	47	EL477G	21
EL27H32DX	121	EL2993BBZ	47	EL477G-RM7W	176
EL27H32ICDA	123	EL2993BZ	47	EL477W	21
EL27H32ICDXA	123	EL2993W	47	EL477W-RM7W	176
EL27H42D	121	EL2993WBZ	47	EL478B	21
EL27H42DX	121	EL2994B	47	EL478W	21
EL27H42DX-7	121	EL2994W	47	EL4M20E	180
EL27H42ICDA	123	EL2999B	47	EL5000	239
EL27H42ICDXA	123	EL2999C	47	EL5001	239
EL27HE13	121	EL2999G	47	EL5002	239
EL27HE13IC	122	EL2999GBZ	47	EL5003	239
EL27HE13ICA	122	EL2999W	47	EL5004A	239
EL27HE18	121	EL300W	19	EL5004B	239
EL27HE18IC	122	EL304B	13	EL5007	239
EL27HE18ICA	122	EL304BG	13	EL5013	239
EL27HE26	121	EL304W	13	EL5016	239
EL27HE26-EM	233	EL304WG	13	EL5018	239
EL27HE26IC	122	EL308W	19	EL5019	239
EL27HE26ICA	122	EL30BZ	19	EL501B	136
EL27HE26ICAN	122	EL30C	13, 19	EL501W	136
EL27HE32	121	EL30CP	19	EL508B	21
EL27HE32-347	121	EL30G	13, 19	EL508W	21
EL27HE32-EM	233	EL30N	13, 19	EL510B	21
EL27HE32ICA	123	EL30W	13, 19	EL510N	21
EL27HE42	121	EL312SH	16, 17	EL510W	21
EL27HE42-EM	233	EL313SH	17	EL511	38
EL27HE42ICA	123	EL316SH	17	EL5110B	72
EL27HICA	122	EL317BZ	20, 176	EL5110W	72
EL27HIC-EM	233	EL317CP	20, 176	EL5111C	72
EL27R18ICD1A	125	EL317G	20, 176	EL5111G	72

Index

EL5111W	72	EL527H26ICDX	133	EL546W	36, 136
EL5112W	35, 136	EL527H32D	132	EL5488W	69
EL5113W	35, 136	EL527H32DX	132	EL5493B	68
EL5116W	36, 136	EL527H32ICDA	134	EL5493W	68
EL511B	31	EL527H32ICDXA	134	EL5497W	69
EL511W	31	EL527H42D	132	EL5498W	69
EL512	38	EL527H42DX	132	EL5511B	70
EL5120W	72	EL527H42ICDA	134	EL5511C	70
EL5121B	72	EL527H42ICDXA	134	EL5511G	70
EL5121C	72	EL527HE13	132	EL5511W	70
EL5121G	72	EL527HE13IC	133	EL5512W	70
EL5121W	72	EL527HE13ICA	133	EL5520W	69
EL512BZ	35	EL527HE18	132	EL5521B	68
EL512CP	35	EL527HE18IC	133	EL5521C	68
EL512K	38	EL527HE18ICA	133	EL5521G	68
EL512KSH	35	EL527HE26	132	EL5521W	68
EL512KW	35	EL527HE26IC	133	EL5534WB	69
EL512N	35, 136	EL527HE26ICA	133	EL5534WW	69
EL512SH	35, 136	EL527HE32	132	EL5552BL	71
EL512W	35, 136	EL527HE32ICA	134	EL5552R	71
EL513	38	EL527HE42	132	EL5552W	71
EL513BZ	35	EL527HE42ICA	134	EL5553BL	71
EL513CP	35	EL527HICA	133	EL5553W	71
EL513K	38	EL527R26ICDA	135	EL5588W	69
EL513KSH	35	EL527RE13ICA	135	EL5593B	68
EL513KW	35	EL527RE18ICA	135	EL5593W	68
EL513N	35	EL527RE26ICA	135	EL5597W	69
EL513SH	35, 136	EL527RH18D	135	EL5598W	69
EL513W	35, 136	EL527RH18DX	135	EL55ICA	30
EL514	38	EL527RH18DX-7	135	EL55RICA	30
EL514SH	35	EL527RH26D	135	EL5610B	71
EL514W	35	EL527RH26DX	135	EL5610W	71
EL515	38	EL527RH26DX-7	135	EL5611C	71
EL515W	36	EL527RH32D	135	EL5611G	71
EL516	38	EL527RH32DX	135	EL5611W	71
EL516BZ	36	EL527RH32DX-7	135	EL5688B	71
EL516CP	36	EL527RH42D	135	EL5688W	71
EL516SH	36, 136	EL527RH42DX	135	EL5698B	71
EL516W	36, 136	EL527RH42DX-7	135	EL5698W	71
EL517	38	EL527RHE13	135	EL575	38
EL517W	36	EL527RHE18	135	EL575B	37
EL518	38	EL527RHE26	135	EL575BG	37
EL5188W	72	EL527RHE32	135	EL575BGG	37
EL518BZ	36	EL527RHE42	135	EL575W	37
EL518CP	37	EL527RHICA	135	EL575WG	37
EL518G	36	EL530	38	EL575WGG	37
EL518N	36	EL530BZ	37	EL576	38
EL518W	36	EL530K	38	EL576B	37
EL519	38	EL530KBZ	37	EL576W	37
EL5193B	72	EL530KW	07, 31, 37	EL577	38
EL5193W	72	EL530W	31	EL577B	37
EL5197W	72	EL5411B	70	EL577C	37
EL5198W	72	EL5411C	70	EL577G	37
EL519BB	37	EL5411G	70	EL577W	37
EL519CW	37	EL5411W	70	EL57H18ICD1A	133
EL519GG	37	EL5412W	70	EL57H26ICD1A	133
EL519GGG	37	EL542	38	EL57R18ICD1A	135
EL519WW	37	EL5420W	69	EL57R26ICD1A	135
EL521B	37	EL5421B	68	EL588B	21
EL521W	37	EL5421C	68	EL588W	21
EL523B	37	EL5421G	68	EL593B	19
EL523W	37	EL5421W	68	EL593W	19
EL525B	37	EL542B	36, 136	EL599B	19
EL525C	37	EL542W	36, 136	EL599C	19
EL525G	37	EL5434WB	69	EL599G	19
EL525W	37	EL5434WW	69	EL599W	19
EL527H18D	132	EL5452BL	71	EL5ICA	29
EL527H18DX	132	EL5452R	71	EL5LV	67
EL527H18ICDX	133	EL5452W	71	EL5LV-EM	235
EL527H26D	132	EL5453BL	71	EL5LVICA	67
EL527H26DX	132	EL5453W	71	EL5RICA	29
EL527H26ICDA	133	EL546B	36, 136	EL5RLV	67

Index

EL600	119	EL623W	27	EL762B	113, 114, 116,
EL6000	239	EL624B	27		117, 153
EL6003	239	EL624W	27	EL762C...	113, 114, 116, 117,
EL6013	239	EL626B	27		153, 227, 231, 232
EL601B	26	EL626W	27	EL762G...	113, 114, 116, 117,
EL601W	26	EL642B	27, 130, 131		153, 227, 231, 232
EL610B	26	EL642C	27, 130, 131	EL762W.....	113, 114, 116,
EL610W	26	EL642G	27, 130, 131		117, 153
EL6113E	130	EL642W	27, 130, 131	EL775	119
EL6113ICDA	130	EL700	119	EL775D	119
EL6113ICEA	130	EL700D	119	EL775DX	119
EL6113RE	131	EL700E	119	EL775E	119
EL6113RICDA	131	EL716C	.05, 111, 112, 156	EL777C...	113, 114, 116, 117,
EL6113RICEA	131	EL716F	.05, 111, 112, 156		153, 227, 231, 232
EL6118E	130	EL716G	.05, 111, 112, 156	EL778C	.115, 118, 154, 229
EL6118ICDA	130	EL721C	113, 114, 116,	EL77W	20
EL6118ICEA	130		117, 153, 227, 231, 232	EL782B	115, 118, 229
EL6118RE	131	EL721F	113, 114, 116,	EL782C	115, 118, 154, 229
EL6118RICDA	131		117, 153	EL782G	115, 118, 154, 229
EL6118RICEA	131	EL721G.....	113, 114, 116, 117,	EL782W	115, 118, 154, 229
EL611B	26		153, 227, 231, 232	EL783B	172, 173, 174
EL611C	26	EL730B.....	113, 114, 116, 117,	EL783W	172, 173, 174
EL611G	26		153, 227, 231, 232	EL799C	172, 173, 174
EL611W	26	EL730BZ	114, 117	EL799F	172, 173, 174
EL6126D	130	EL730CP	114, 117	EL799G	172, 173, 174
EL6126E	130	EL730N	113, 114, 116, 117	EL79W	19
EL6126ICD1A	130	EL730W	113, 114, 116, 117,	EL7IC	10
EL6126ICDA	130		153, 227, 231, 232	EL7IC100A	10
EL6126ICEA	130	EL731B	115, 118, 154, 229	EL7ICA	10
EL6126RD	131	EL731N	115, 118, 229	EL7ICANB	10
EL6126RDX	131	EL731W	115, 118, 154, 229	EL7ICNB	10
EL6126RE	131	EL732B	111, 112	EL7LV	60
EL6126RICD1A	131	EL732C	.05, 111, 112, 156	EL7LV-277	60
EL6126RICDA	131	EL732F	.05, 111, 112	EL7LV-EM	235
EL6126RICEA	131	EL732G	.05, 111, 112, 156	EL7LVICA	60
EL613	130	EL732W	111, 112	EL7RICA	10
EL6132D	130	EL733B	.05, 111, 112, 156	EL7RLV	60
EL6132DX	130	EL733N	111, 112	EL7RLV-277	60
EL6132E	130	EL733W	.05, 111, 112, 156	EL800	109
EL6132RD	131	EL737C	.05, 172, 173, 174	EL800D	109
EL6132RE	131	EL737F.....	111, 112, 172,	EL800E	109
EL613R	131		173, 174	EL800E-347	109
EL6142D	130	EL738C	111, 112	EL816C	.04, 99, 100,
EL6142DX	130	EL741C	.115, 118, 154, 229		101, 152
EL6142E	130	EL741F	.115, 118, 229	EL816F	.04, 100, 101, 152
EL6142RD	131	EL741G	.115, 118, 154, 229	EL816G	.04, 99, 100,
EL6142RDX	131	EL742B...	113, 114, 116, 117,		101, 152
EL6142RE	131		153, 227, 231, 232	EL821C...	102, 103, 105, 107,
EL616B	27, 130, 131	EL742BZ	113, 114, 116, 117		149, 223, 225
EL616C	27, 130, 131	EL742CP	114, 117	EL821F.....	102, 103, 105,
EL616G	27, 130, 131	EL742N.....	113, 114, 116,		107, 149
EL616KC	27, 130, 131		117, 231, 227	EL821G...	102, 103, 105, 107,
EL616KG	27	EL742W...	113, 114, 116, 117,		149, 223, 225
EL616W	27, 130, 131		153, 227, 231, 232	EL821W	102, 103, 105, 107,
EL618B	27	EL743B	115, 118, 154, 229	EL826C...	102, 103, 105, 107,
EL618W	27	EL743N	115, 118, 229		149, 223, 225
EL619CW	27	EL743W	115, 118, 154, 229	EL826G...	102, 103, 105, 107,
EL619WW	27	EL745B...	113, 114, 116, 117,		149, 223, 225
EL6213	130		153, 227, 231, 232	EL827C.....	104, 106, 108,
EL6213E	130	EL745W...	113, 114, 116, 117,		150, 224
EL6213R	131		153, 227, 231, 232	EL827G	104, 106, 108, 224
EL6213RE	131	EL746B	115, 118, 229	EL828C	152
EL621B	119, 155	EL746W	115, 118, 229	EL828G	152
EL621C	119, 155	EL750	119	EL830B	.102, 103, 105, 107,
EL621G	119, 155	EL750D	119		149, 223, 225
EL621W	119	EL750E	119	EL830W.....	102, 103, 105,
EL622B	27, 130, 131	EL752B	.05, 111, 112, 156		107, 149, 223, 225
EL622BG	27	EL752W	.05, 111, 112, 156	EL831B.....	104, 106, 108,
EL622KB	27, 130	EL755B	.05, 111, 112, 156		150, 224
EL622KBG	27	EL755W	.05, 111, 112, 156	EL831W.....	104, 106, 108,
EL622KW	24, 27, 130, 131	EL757B	172, 173, 174		150, 224
EL622W	27, 130, 131	EL757W	172, 173, 174	EL832C...	.04, 99, 100, 101, 152

Index

EL832F	.04, 100, 101	EL8SQ-142E	.110	EL915W	.49, 143
EL832G	.04, 99, 101, 152	EL8SQ-213	.110	EL916B	.49, 143
EL832W	.100, 101	EL8SQ-213E	.110	EL916BZ	.49, 143
EL833B	.04, 99, 100, 101, 152	EL8SQ-226D	.110	EL916C	.49, 143
EL833W	.04, 99, 100, 101, 152	EL8SQ-226E	.110	EL916CP	.49, 143
EL836C	.100, 101	EL8SQ-232D	.110	EL916G	.49, 143
EL836G	.100, 101	EL8SQ-232E	.110	EL916N	.49
EL837C	.169, 170, 171	EL8SQ-242D	.110	EL916SH	.49
EL837F	.169, 170, 171	EL8SQ-242E	.110	EL916W	.49, 143
EL838C	.04, 100, 101	EL900HT	.24, 25	EL918ICA	.25
EL841C	.104, 106, 108, 150, 224	EL900RT	.25	EL918RICA	.25
EL841F	.104, 106, 150	EL901W	.09, 46	EL921B	.109, 151
EL841G	.104, 106, 108, 150, 224	EL9111SH	.48	EL921C	.109, 151
EL841W	.104, 106, 108, 224	EL9111W	.48, 142	EL921G	.109, 151
EL842B	.102, 103, 105, 107, 149, 223, 225	EL9112B	.48, 142	EL921W	.109, 151
EL842W	.102, 103, 105, 107, 149, 223, 225	EL9112BZ	.48, 142	EL925C	.45, 144
EL843B	.104, 106, 108, 150, 224	EL9112C	.48, 142	EL925G	.45, 144
EL843W	.104, 106, 108, 150, 224	EL9112CP	.48, 142	EL925KC	.45
EL850	.109	EL9112G	.48, 142	EL925W	.45
EL850D	.109	EL9112N	.48	EL926B	.46, 144
EL850E	.109	EL9112SH	.48	EL926BZ	.46, 144
EL850E-347	.109	EL9112W	.48, 142	EL926C	.08, 46, 144
EL852B	.04, 99, 100, 101, 152	EL9113BZ	.48, 142	EL926CP	.46, 144
EL852W	.04, 99, 100, 101, 152	EL9113CP	.48, 142	EL926G	.46, 144
EL857B	.169, 170, 171	EL9113G	.48, 142	EL926N	.46, 144
EL857W	.169, 170, 171	EL9113SH	.48	EL926W	.46, 144
EL862C	.102, 103, 105, 107, 149, 223, 225	EL9113W	.48, 142	EL930W	.45
EL862G	.102, 103, 105, 107, 149, 223, 225	EL9114BZ	.49	EL934WB	.50
EL875	.109	EL9114CP	.49	EL934WW	.50
EL875D	.109	EL9114SH	.49	EL936ICA	.26
EL875E	.109	EL9114W	.49	EL941B	.45
EL875E-347	.109	EL9115BZ	.49, 142	EL941W	.45
EL880D	.109	EL9115CP	.49, 142	EL952BL	.46, 144
EL880E	.109	EL9115SH	.49	EL952R	.46, 144
EL880E-347	.109	EL9115W	.49, 142	EL952W	.41, 46, 144
EL882C	.104, 106, 108, 150, 224	EL9116B	.49	EL953BL	.41, 46, 144
EL882G	.104, 106, 108, 150, 224	EL9116BZ	.49, 142	EL953W	.46, 144
EL883B	.169, 170, 171	EL9116C	.49	EL955B	.41, 50, 51
EL883W	.169, 170, 171	EL9116CP	.50, 142	EL955BW	.50
EL885D	.109	EL9116G	.49, 142	EL955W	.41, 50, 51
EL885E	.109	EL9116SH	.49	EL977B	.47, 179
EL888C	.102, 103, 105, 107, 149, 223, 225	EL9116W	.49, 142	EL977C	.47, 51, 179
EL888G	.102, 103, 105, 107, 149, 223, 225	EL911BZ	.48, 142	EL977G	.47, 51, 179
EL889C	.104, 106, 108, 150, 224	EL911CP	.48, 142	EL977W	.47, 179
EL889G	.104, 106, 108, 150, 224	EL911SH	.48	EL985B	.47, 179
EL899C	.169, 170, 171	EL911W	.48, 142	EL985BZ	.47, 179
EL899F	.169, 170, 171	EL912B	.48, 143	EL985CP	.47, 179
EL8SQ	.28	EL912BZ	.48, 143	EL985F	.179
EL8SQ-118E	.110	EL912C	.48, 143	EL985N	.08, 47, 179
EL8SQ-126D	.110	EL912CP	.48, 143	EL985W	.47
EL8SQ-126E	.110	EL912G	.48, 143	EL988B	.50, 51
EL8SQ-132D	.110	EL912N	.48, 143	EL988BW	.50, 51
EL8SQ-132E	.110	EL912SH	.48	EL988G	.50, 51
EL8SQ-142D	.110	EL912W	.08, 48, 143	EL988W	.50, 51
		EL913BZ	.48, 143	EL99	.40, 42, 52
		EL913CP	.48, 143	EL990BZ	.45
		EL913G	.48, 143	EL990CP	.45
		EL913N	.48	EL990N	.45
		EL913SH	.48	EL990W	.45
		EL913W	.08, 48, 143	EL992B	.41, 45
		EL914B	.48, 143	EL992KW	.45, 144
		EL914BZ	.49, 143	EL992W	.41, 45
		EL914CP	.49, 143	EL993B	.43, 144
		EL914SH	.48	EL993BB	.43
		EL914W	.48, 143	EL993BBZ	.43
		EL915B	.49, 143	EL993BC	.43
		EL915BZ	.49, 143	EL993BCP	.43
		EL915C	.49, 143	EL993BG	.43
		EL915CP	.49, 143	EL993BN	.43
		EL915G	.49, 143	EL993BZ	.43
		EL915N	.49, 143	EL993BZW	.43
		EL915SH	.49	EL993CP	.43

Index

EL993CPB	43	EL99PLICEA	139	ELH118D	116
EL993CPW	43	EL99R	42	ELH118E	116
EL993KB	44	EL99RA	42	ELH118ICE	102
EL993KBN	44	EL99RPL	141	ELH126D	105
EL993KBZ	44	EL99RPL18DXA	141	ELH126DX	105
EL993KCP	44	EL99RPL18EA	141	ELH126E	105
EL993KCPW	44	EL99RPL18ICEA	141	ELH126E-EM	222
EL993KN	44	EL99RPL26DA	141	ELH126ICD	102
EL993KNB	44	EL99RPL26DXA	141	ELH126ICE	102
EL993KNW	44	EL99RPL26EA	141	ELH132D	105
EL993KW	44	EL99RPL32DA	141	ELH132DX	105
EL993MB	44, 179	EL99RPL32DXA	141	ELH132E	105
EL993MW	44, 179	EL99RPL32EA	141	ELH132E-EM	222
EL993N	43, 144	EL99RPLE	141	ELH132ICD	102
EL993NB	43	EL99RPLICEA	141	ELH132ICE	102
EL993NW	43	ELA101B	13, 127, 234	ELH142D	105
EL993SB	44	ELA101BZ	13, 127	ELH142DX	105
EL993SW	44	ELA101CP	13, 127	ELH142E	105
EL993W	43, 144	ELA101N	13, 127	ELH142E-EM	222
EL993WBZ	44, 144	ELA101NB	13, 127	ELH142ICD	102
EL993WCP	44, 144	ELA101NW	13	ELH142ICE	102
EL993WG	43	ELA101W	13, 234	ELH142ICEA	102
EL993WN	43	ELA101WA	13	ELH213	116
EL994B	44	ELA102B	13, 129	ELH213D	116
EL994BG	45	ELA102BZ	13, 129	ELH213E	116
EL994DB	45	ELA102CP	14, 129	ELH213E-EM	230
EL994DW	08, 45	ELA102N	13, 129	ELH213IC-EM	232
EL994W	44, 144	ELA102W	13, 129	ELH213EM	230
EL995B	45, 47, 179	ELA105B	22, 127	ELH213IC	113
EL995BZ	45, 179	ELA105W	22, 127	ELH213ICD	113
EL995CP	45, 179	ELA499SC	144	ELH213ICE	113
EL995N	45, 179	ELA501	38	ELH213ICEA	113
EL995W	45, 47, 179	ELA501B	31	ELH213ICE-EM	232
EL996W	50	ELA501W	31	ELH218	116
EL998B	50, 51, 179	ELA5099	38	ELH218D	116
EL998BZ	50, 179	ELA5099B	33	ELH218DX	116
EL998C	50, 51, 179	ELA5099C	33	ELH218E	116
EL998CP	50, 179	ELA5099G	33	ELH218E-EM	230
EL998G	50, 51, 179	ELA5099W	33	ELH218EM	230
EL998N	50, 51, 179	ELA599	38	ELH218ICD	102
EL998SB	50	ELA599CBZ	33	ELH218ICE	102, 113
EL998W	50, 51, 179	ELA599CCP	33	ELH218ICE-EM	225
EL999B	46, 144, 179	ELA599GBZ	33	ELH226D	105
EL999BZ	46, 144	ELA599SB	33, 136	ELH226DX	105
EL999C	41, 46, 144, 179	ELA599SC	33, 136	ELH226E	105
EL999CC	46, 144	ELA599SG	33, 136	ELH226ICD	102
EL999CN	46	ELA599SW	33, 136	ELH226ICDX	102
EL999CP	46, 144	ELA85SB	129	ELH226ICE	102
EL999DC	46, 144	ELA85SC	129	ELH226ICEA	102
EL999DG	41, 46, 144	ELA85SG	129	ELH226ICE-EM	225
EL999G	46, 144, 179	ELA85SW	129	ELH232D	106
EL999GBZ	46	ELA88SB	129	ELH232DX	106
EL999GCP	46	ELA88SC	129	ELH232DX-7	106
EL999GG	46, 144	ELA88SG	129	ELH232E	106
EL999GN	46	ELA88SW	129	ELH242D	106
EL999KC	46	ELA95SB	18, 127	ELH242DX	106
EL999KCBZ	46	ELA95SC	18, 127	ELH242DX-7	106
EL999KG	46	ELA95SG	18, 127	ELH242E	106
EL999W	46, 144, 179	ELA95SW	18, 127	ELH29	116
EL99A	42, 52	ELA99SB	18, 127, 234	ELH29IC	113
EL99IC	42	ELA99SC	18, 127, 233	ELH7113	114
EL99ICA	42	ELA99SCBZ	18	ELH7113E	114
EL99PL	139	ELA99SCCP	18	ELH7118	114
EL99PL18ICD1A	140	ELA99SC-RM7W	176	ELH7118E	114
EL99PL18ICDA	140	ELA99SG	18, 127, 233	ELH7126	114
EL99PL18ICDXA	140	ELA99SG-RM7W	176	ELH7126D	114
EL99PL18ICEA	140	ELA99SW	18, 127, 234	ELH7126DX	114
EL99PL26ICD1A	140	ELH113	116	ELH7126DX-7	114
EL99PL26ICDA	140	ELH113E	116	ELH7126E	114
EL99PL26ICDXA	140	ELH113IC	113	ELH7126E-EM	226
EL99PL26ICEA	140	ELH113ICE	113	ELH7132D	115
EL99PLE	139	ELH118	116	ELH7132DX	115

Index

ELH7132DX-7	115	ELH8242DX-7	104	ELM48BGG	22
ELH7132E	115	ELH8242E	104	ELM48BZ	22
ELH7132E-EM	228	ELH8242E-EM	224	ELM48CP	22
ELH7142D	115	ELH829	103	ELM48N	22
ELH7142DX	115	ELH8T	04	ELM48NW	22
ELH7142DX-7	115	ELM205B	129	ELM48W	22
ELH7142E	115	ELM205W	129	ELM48WG	22
ELH7142E-EM	228	ELM300B	14, 127	ELM48WGG	22
ELH7213	114	ELM300BZ	127	ELM500	38
ELH7213D	114	ELM300W	14, 127	ELM500B	31
ELH7213E	114	ELM301W	19, 127	ELM500W	09, 31
ELH7213E-EM	226	ELM302B	14	ELM500WW	31
ELH7213EM	226	ELM302W	14	ELM501	38
ELH7218	114	ELM303W	14	ELM501W	09, 34
ELH7218D	114	ELM305W	14	ELM5033	38
ELH7218E	114	ELM30B	14	ELM5033B	31
ELH7218E-EM	226	ELM30BB	14	ELM5033CP	31
ELH7218EM	226	ELM30BBZ	14	ELM5033N	31
ELH7218ICE	114	ELM30BCP	14	ELM5033W	31
ELH7226	115	ELM30BG	14	ELM5045	38
ELH7226D	115	ELM30BOV	14	ELM5045B	31, 136
ELH7226DX	115	ELM30B-RM7G	177	ELM5045W	31, 136
ELH7226DX-7	115	ELM30BZ	14	ELM530	38
ELH7226E	115	ELM30BZB	14	ELM530B	31, 136
ELH7226E-EM	228	ELM30BZW	14	ELM530BG	31
ELH729	114	ELM30CP	14	ELM530BOV	32
ELH7LV	60	ELM30CPB	14	ELM530BZ	31
ELH7LV-277	60	ELM30CPW	14	ELM530BZB	31
ELH7M100	175	ELM30N	14, 177	ELM530BZW	31
ELH7M100E	175	ELM30NB	14	ELM530CP	31
ELH7M35	175	ELM30NW	14	ELM530CPB	31
ELH7M35E	175	ELM30W	14	ELM530CPW	31
ELH7M50	175	ELM30WBZ	14	ELM530K	38
ELH7M50E	175	ELM30WCP	14	ELM530KB	32
ELH7M70	175	ELM30WG	14	ELM530KBCP	32
ELH7M70E	175	ELM30WOV	14	ELM530KBZ	32
ELH7T	05	ELM30W-RM7W	177	ELM530KCP	32
ELH8113	103	ELM38B	22	ELM530KN	32
ELH8118	103	ELM38BG	22	ELM530KW	32
ELH8118E	103	ELM38BGG	22	ELM530N	31, 136
ELH8126	103	ELM38BZ	22	ELM530NB	32
ELH8126D	103	ELM38CP	22	ELM530NW	32
ELH8126E	103	ELM38N	22	ELM530W	31, 136
ELH8126E-EM	222	ELM38W	22	ELM530WOV	32
ELH8132D	103	ELM40B	14	ELOLK75	162
ELH8132E	103	ELM40BBZ	15	ELP30B	15
ELH8132E-EM	222	ELM40BCP	15	ELP30BG	15
ELH8142D	103	ELM40BOV	15	ELP30W	15
ELH8142E	103	ELM40B-RM7W	177	ELP30WG	15
ELH8142E-EM	222	ELM40BZ	15	ELP40B	15
ELH8213	103	ELM40CP	15	ELP40W	15
ELH8213D	103	ELM40N	14, 177	ELP530	38
ELH8213E	103	ELM40W	14	ELP530B	32, 136
ELH8213EM	222	ELM40WOV	15	ELP530BG	32
ELH8218	103	ELM40W-RM7W	177	ELP530BN	32
ELH8218D	103	ELM412W	127	ELP530K	38
ELH8218DX	103	ELM422W	17, 127	ELP530KB	32
ELH8218E	103	ELM42B	17, 129	ELP530KBBZ	32
ELH8218EM	222	ELM42BZ	17, 129	ELP530KBCP	32
ELH8226	103	ELM42CP	17, 129	ELP530KBN	32
ELH8226D	103	ELM42N	17	ELP530KW	07, 32
ELH8226DX	103	ELM42W	17, 129	ELP530KWN	32
ELH8226E	103	ELM43B	17	ELP530W	32, 136
ELH8226E-EM	222	ELM43W	17	ELP530WCP	32
ELH8226EM	222	ELM45B	22	ELP530WN	32
ELH8232D	104	ELM45W	22	ELR2533B	237
ELH8232DX	104	ELM46B	17, 127, 129	ELR2533BBZ	237
ELH8232DX-7	104	ELM46W	17, 127, 129	ELR2533BCP	237
ELH8232E	104	ELM47W	17, 127	ELR2533BZ	237
ELH8232E-EM	224	ELM48B	22	ELR2533CP	237
ELH8242D	104	ELM48BB	22	ELR2533W	237
ELH8242DX	104	ELM48BG	22	ELR317BZ	237

Index

ELR317CP	237	ELS40GRM7W	176	ELST43B	204
ELR317G	237	ELS42B	17, 129	ELST43W	204
ELR317W	237	ELS42C	17, 127, 129	ELST44B	202
ELR376B	237	ELS42G	17, 129	ELST44W	202
ELR376N	237	ELS42W	17, 127, 129	ELST45B	202
ELR376W	237	ELS5030	38	ELST45W	202
ELR4M20E	180	ELS5030C	34	ELST46B	202
ELRH113E	117	ELS5030G	34	ELST46W	202
ELRH118D	117	ELS5030W	34	ELST47B	202
ELRH126D	107	ELS511	38	ELST47W	202
ELRH126DX	107	ELS511C	34	ELST49B	204
ELRH126DX-7	107	ELS520	38	ELST49W	204
ELRH126E	107	ELS520B	34	ELST52B	204
ELRH132D	107	ELS520C	34	ELST52W	204
ELRH132DX	107	ELS520G	34	ELST53B	203
ELRH132DX-7	107	ELS520W	34	ELST53W	203
ELRH132E	107	ELS530	38	ELST54B	203
ELRH142D	107	ELS530B	34	ELST54W	203
ELRH142DX	107	ELS530C	34	ELST55B	203
ELRH142DX-7	107	ELS530CC	34	ELST55W	203
ELRH142E	107	ELS530G	34	ELST56B	203
ELRH213	117	ELS530GG	34	ELST56W	203
ELRH213D	117	ELS530K	38	ELST61B	207
ELRH213E	117	ELS530KB	34	ELST61BZ	207
ELRH218D	117	ELS530KC	34	ELST61N	207
ELRH218DX	117	ELS530KG	34	ELST61W	207
ELRH218DX-7	117	ELS530KW	34	ELST62B	207
ELRH218E	117	ELS530W	34	ELST62BZ	207
ELRH226D	107	ELS542B	34, 36, 136	ELST62N	207
ELRH226DX	107	ELS542C	34, 36, 136	ELST62W	207
ELRH226DX-7	107	ELS542G	34, 36, 136	ELST63B	207
ELRH226E	107	ELS542W	34, 36, 136	ELST63BZ	207
ELRH232D	108	ELST10B	206	ELST63N	207
ELRH232DX	108	ELST10W	206	ELST63W	207
ELRH232DX-7	108	ELST11B	206	ELST64B	207
ELRH232E	108	ELST11W	206	ELST64BZ	207
ELRH242D	108	ELST20B	205	ELST64N	207
ELRH242DX	108	ELST20BZ	205	ELST64W	207
ELRH242DX-7	108	ELST20W	205	ELST65B	207
ELRH242E	108	ELST21B	205	ELST65BZ	207
ELRH7126D	118	ELST21BZ	205	ELST65N	207
ELRH7126DX	118	ELST21W	205	ELST65W	207
ELRH7126DX-7	118	ELST22B	205	ELST66B	207
ELRH7132D	118	ELST22BZ	205	ELST66BZ	207
ELRH7132DX	118	ELST22W	205	ELST66N	207
ELRH7132DX-7	118	ELST23B	205	ELST66W	207
ELRH7132E	118	ELST23BZ	205	ELST71B	207
ELRH7142D	118	ELST23W	205	ELST71BZ	207
ELRH7142DX	118	ELST31B	201	ELST71N	207
ELRH7142DX-7	118	ELST31W	201	ELST71W	207
ELRH7142E	118	ELST32B	201	ELST72B	207
ELRH7226E	118	ELST32W	201	ELST72BZ	207
ELRH7M100E	175	ELST33B	202	ELST72N	207
ELRH7M35E	175	ELST33W	202	ELST72W	207
ELRH7M70E	175	ELST34B	202	ELST73B	207
ELS30B	18, 234	ELST34W	202	ELST73BZ	207
ELS30BRM7W	176	ELST35B	202	ELST73N	207
ELS30BZ	18	ELST35W	202	ELST73W	207
ELS30C	18, 234	ELST36B	202	ELST74B	207
ELS30CC	18	ELST36W	202	ELST74BZ	207
ELS30CP	18	ELST37B	201	ELST74N	207
ELS30CRM7W	176	ELST37W	201	ELST74W	207
ELS30G	18, 234	ELST38B	202	ELST75B	207
ELS30GG	18	ELST38W	202	ELST75BZ	207
ELS30GRM7W	176	ELST39B	202	ELST75N	207
ELS30W	18, 234	ELST39W	202	ELST75W	207
ELS30WRM7W	176	ELST40B	202	ELST76B	207
ELS310C	18, 127	ELST40W	202	ELST76BZ	207
ELS311C	09, 18, 127	ELST41B	202	ELST76N	207
ELS40C	18, 234	ELST41W	202	ELST76W	207
ELS40CRM7W	176	ELST42B	203	ELV4113E	138
ELS40G	18, 234	ELST42W	203	ELV4113E-347	138

Index

ELV4118D	138	EMH175L	211	ERT885E	151
ELV4118DX	138	EMH250	210	ERTH7118D	153
ELV4118E	138	EMH250L	211	ERTH7118DX	153
ELV4118E-347	138	EMH400	210	ERTH7118DX-7	153
ELV4126D	138	EMH400L	211	ERTH7118E	153
ELV4126DX	138	EMH70	210	ERTH7126D	154
ELV4126E	138	EPC2	196	ERTH7126DX	154
ELV4132D	138	EPC3	196	ERTH7126DX-7	154
ELV4132DX	138	EPCH	196	ERTH7126E	154
ELV4132E	138	EPD-10	188	ERTH7132D	154
ELV7113	111	EPD10-24	188	ERTH7132DX	154
ELV7113E	111	EPD-10-Z	188	ERTH7132DX-7	154
ELV7118	111	EPD-11	188	ERTH7132E	154
ELV7118D	111	EPD-12	188	ERTH7142D	154
ELV7118E	111	EPD-2	188, 189	ERTH7142DX	154
ELV7126	111	EPD-20	188	ERTH7142DX-7	154
ELV7126D	111	EPD-3	188	ERTH7142E	154
ELV7126DX	111	EPD-35	188	ERTH7213D	153
ELV7126E	111	EPD-4	188, 189	ERTH7213E	153
ELV7132D	111	EPD-5	188	ERTH7218D	153
ELV7132DX	111	EPD5-24	188	ERTH7218DX	153
ELV7132E	111	EPD-5-Z	188	ERTH7218DX-7	153
ELV7132E-347	111	EPD-6	188, 189	ERTH7218E	153
ELV7142D	111	EPD-9	188	ERTH7226D	154
ELV7142DX	111	EPEN	196	ERTH7226DX	154
ELV7142E	111	EPMT	196	ERTH7226DX-7	154
ELV7142E-347	111	EPN2	196	ERTH7226E	154
ELV8113	100	EPS100	209	ERTH8126D	149
ELV8113E	100	EPS100M	212	ERTH8126DX	149
ELV8118	100	EPS100S	212	ERTH8126DX-7	149
ELV8118E	100	EPS150	209	ERTH8126E	149
ELV8126	100	EPS150M	212	ERTH8132D	150
ELV8126D	100	EPS150S	212	ERTH8132DX	150
ELV8126DX	100	EPS2	196	ERTH8132E	150
ELV8126DX-7	100	EPS250	209	ERTH8132DX-7	150
ELV8126E	100	EPS250L	212	ERTH8142D	150
ELV8126E-347	100	EPS35	209	ERTH8142DX	150
ELV8132D	100	EPS35M	212	ERTH8142DX-7	150
ELV8132DX	100	EPS35S	212	ERTH8142E	150
ELV8132DX-7	100	EPS400	209	ERTH8213D	149
ELV8132E	100	EPS400L	212	ERTH8213E	149
ELV8132E-347	100	EPS50	209	ERTH8218D	149
ELV8142D	100	EPS50M	212	ERTH8218DX	149
ELV8142DX	100	EPS50S	212	ERTH8218DX-7	149
ELV8142DX-7	100	EPS70	209	ERTH8218E	149
ELV8142E	100	EPS70M	212	ERTH8226D	149
ELV8142E-347	100	EPS70S	212	ERTH8226DX	149
ELVF713	112	EPT2	196	ERTH8226DX-7	149
ELVF713E	112	EPT3	196	ERTH8226E	149
ELVF718	112	ER4M20E	178	ERTH8232D	150
ELVF718E	112	ER4M35E	178	ERTH8232DX	150
ELVF726	112	ERT700D	155	ERTH8232DX-7	150
ELVF726D	112	ERT700E	155	ERTH8232E	150
ELVF726E	112	ERT750D	155	ERTH8242D	150
ELVF732D	112	ERT750DX	155	ERTH8242DX	150
ELVF732E	112	ERT750DX-7	155	ERTH8242DX-7	150
ELVF742D	112	ERT750E	155	ERTH8242E	150
ELVF742E	112	ERT775D	155	ERTV7113E	156
ELVF813	101	ERT775DX	155	ERTV7118D	156
ELVF813E	101	ERT775DX-7	155	ERTV7118DX	156
ELVF818	101	ERT775E	155	ERTV7118DX-7	156
ELVF818E	101	ERT800D	151	ERTV7118E	156
ELVF826	101	ERT800E	151	ERTV7126D	156
ELVF826D	101	ERT850D	151	ERTV7126DX	156
ELVF826E	101	ERT850DX	151	ERTV7126DX-7	156
ELVF832D	101	ERT850DX-7	151	ERTV7126E	156
ELVF832E	101	ERT850E	151	ERTV7132D	156
ELVF842D	101	ERT875D	151	ERTV7132DX	156
ELVF842E	101	ERT875DX	151	ERTV7132DX-7	156
EMH100	210	ERT875DX-7	151	ERTV7132E	156
EMH100L	211	ERT875E	151	ERTV7142D	156
EMH175	210	ERT880E	151	ERTV7142DX	156

Index

ERTV7142DX-7	156	EUB42EN	184	F8T5	194
ERTV7142E	156	EUBL12	194	FB27	241
ERTV8113E	152	EUBL21	194	HB24	241
ERTV8118D	152	EUBL24	194	JC-20	194
ERTV8118DX	152	EUBL32	194	JC-20-Z	194
ERTV8118DX-7	152	EUBL42	194	JC-25	194
ERTV8118E	152	EUC22B	185	JC-35	194
ERTV8126D	152	EUC22W	185	JDR	245
ERTV8126DX	152	EUC33B	185	KEM-100W	220
ERTV8126DX-7	152	EUC33W	185	KEM-200W	220
ERTV8126E	152	EUC41B	185	KEM-50W	220
ERTV8132D	152	EUC41W	185	KEM-P13	234, 241
ERTV8132DX	152	EUC42B	185	KEM-P26	234, 241
ERTV8132DX-7	152	EUC42W	185	KEM-P32	234, 241
ERTV8132E	152	EUC43B	185	KEM-P42	234, 241
ERTV8142D	152	EUC43W	185	KEM-P43	234, 241
ERTV8142DX	152	EUC51BZ	186	KPL-113	162
ERTV8142DX-7	152	EUC51W	186	KPL-13E	161
ERTV8142E	152	EUC52BZ	186	KPL-18E	161
ERTV9113E	148	EUC52W	186	KPL-201B	158
ERTV9118E	148	EUC53BZ	186	KPL-201EW	158
ERTV9126D	148	EUC53W	186	KPL-201W	158
ERTV9126DX	148	EUC54BZ	186	KPL-201W-HP	158
ERTV9126DX-7	148	EUC54W	186	KPL-202EW	158
ERTV9126E	148	EUCRD	194	KPL-203E B/W	158
ERTV9132D	148	EUL12	194	KPL-204E B/W	158
ERTV9132DX	148	EUL21	194	KPL-213	162
ERTV9132DX-7	148	EUL24	194	KPL-26E	161
ERTV9132E	148	EUL32	194	KPL-32E	161
ERTV9142D	148	EUL42	194	KPL-501B	164
ERTV9142DX	148	EUL51	194	KPL-501E	165
ERTV9142DX-7	148	EUL52	194	KPL-501W	164
ERTV9142E	148	EUL53	194	KPL-502E	165
ERTV9157D	148	EUL54	194	KPL-503E	165
ERTV9157DX	148	EUN12E	182	KPL-504E	165
ERTV9157DX-7	148	EUN12EL	182	KPL-5113	166
ERTV9157E	148	EUN21E	182	KPL-513E	166
ERTV9170D	148	EUN21EL	182	KPL-518E	166
ERTV9170DX	148	EUN24E	182	KPL-5213	166
ERTV9170DX-7	148	EUN24EL	182	KPL-526E	166
ERTV9170E	148	EUN32E	182	KPL-532E	166
ES1303	213	EUN32EL	182	KPL-56B	164
ES2603	213	EUN42E	182	KPL-56C	164
ETR 60	198	EUN42EL	182	KPL-56E	165
ETR105	198	EUOUT	194	KPL-56EG	165
ETR12	198	EUS14L	194	KPL-56EW	165
ETR12-277	198	EUS14W	183	KPL-56G	164
ETR12-75	198	EUS21L	194	KPL-56W	164
ETR150	198	EUS21W	183	KPL-57E	165
ETR240	197	EUS28L	194	KPL-57EG	165
ETR-277	198	EUS28W	183	KPL-57EW	165
ETR480	197	EUS8L	194	KPL-58E	165
ETR50	198	EUS8W	183	KPL-58EG	165
ETR60-PLG	198	EUSC12	183	KPL-58EW	165
ETR75	198	EUSC24	183	KPL-59E	165
ETR80	198	EUSC36	183	KPL-59EG	165
ETR80-PLG	198	EUSC6	183	KPL-59EW	165
ETRK50	72, 198	EUSWT1	194	KPL-62C	158
EUB12E	184	EUSWT2	194	KPL-62E	159
EUB12EL	184	EUSWT3	194	KPL-63E	159
EUB12EN	184	EUZ56BZ	187	KPL-64E	159
EUB21E	184	EUZ56W	187	KPL-65E	159
EUB21EL	184	EUZ57BZ	187	KPL-66B	158
EUB21EN	184	EUZ57W	187	KPL-66C	158
EUB24E	184	EUZ58BZ	187	KPL-66C-HP	158
EUB24EL	184	EUZ58W	187	KPL-66E	159
EUB24EN	184	EUZ59BZ	187	KPL-66G	158
EUB32E	184	EUZ59W	187	KPL-66W	158
EUB32EL	184	F13T5	194	KPL-67E	159
EUB32EN	184	F14T5	194	KPL-68E	159
EUB42E	184	F21T5	194	KPL-69E	159
EUB42EL	184	F28T5	194	KPW-201B	158

Index

KPW-201E	160	P016S	241	PST2L	206
KPW-201W	158	P035MH	243	PST4B	206
KPW-202E	160	P035MHE1	243	PST4W	206
KPW-203E	160	P035MHE2	243	PST5B	206
KPW-204E	160	P050HP	243	PST5W	206
KPW-62C	159	P050MH	243	PWH2E1	242
KPW-66B	159	P050MHE2	243	R10H	11
KPW-66C	159	P070HP	243	R5H	29
KPW-66E	160	P070MH	243	R9H	11
KPW-66G	159	P070MHE1	243	R9ICA	12
KPW-66W	159	P070MHE2	243	RM3B	240
KPW-67E	160	P100HP	243	RM3BZ	240
KPW-68E	160	P100MHE1	243	RM3C	240
KPW-69E	160	P100MHE2	243	RM3CP	240
L15	219	P113E1	242	RM3G	240
L28	240	P118DX	242	RM3N	240
L29	240	P118E1	242	RM3W	240
L30	240	P126E1	242	RM4B	240
L31	240	P13	246	RM4BZ	240
L32	240	P13-4	246	RM4C	240
L33	240	P13Q	246	RM4CP	240
L34	240	P13T-4	246	RM4G	240
L35	240	P142D1	242	RM4N	240
L36	240	P142DU	242	RM4W	240
L38	240	P142DX	242	RM5B	240
L39	240	P142DX-7	242	RM5BZ	240
L4	219	P142EU	242	RM5C	240
L40	240	P150HP	243	RM5CP	240
L41	240	P150MH	243	RM5G	240
L42	240	P150MHE2	243	RM5N	240
L43	240	P175MH	243	RM5W	240
L44	240	P18	246	RM7B	240
L-BRCKT	242	P18-4	246	RM7BZ	240
LET100	197	P18T4	246	RM7C	240
LET151	197	P213EU	242	RM7CP	240
LET303	197	P218D1	242	RM7G	240
LET75	197	P218DX	242	RM7N	240
LU100	245	P218EU	242	RM7W	240
LU150	245	P226DX	242	RM8W	240
LU250	245	P242DU	242	RM9W	240
LU35	245	P242DX	242	RP1B	241
LU400	245	P242EU	242	RP5A	241
LU50	245	P250MH	243	RP7B	240
LU70	245	P26	246	RP7W	240
LVT151	197	P26-4	246	RR10H	11
LVT303	197	P26T-4	246	RR300W	58
LVT303-24	197	P32T-4	246	RR301B	58
LVT303-DC	197	P42Q-4	246	RR301W	58
MR11NFL	243	P7	246	RR302W	58
MR11NSP	243	P75-7	198	RR5H	30
MR120	245	P9	246	RR9H	12
MR16-6V	216	PAR20F35M	245	RR9ICA	12
MR16EXN	243	PAR20F50	245	SPRING	241
MR16EXZ	243	PAR20S35M	245	T-SWITCH	242
MR16EYC	243	PAR20S50	245	V-SPRING	241
MVR100	245	PAR30F70M	245	WB-10-Z	189
MVR150	245	PAR30F75	245	WB-10-Z-24	189
MVR175	245	PAR30S35M	245	WB-10-ZF	189
MVR250	245	PAR30S70M	245	WB-10-ZF-24	189
MVR32	245	PAR30S75	245	WB-18-Z	194
MVR400	245	PAR38F100M	245	WB-5-Z	189
MVR70	245	PAR38F120	245	WB-5-ZF	189
OM4B	240	PAR38F70M	245	WB-5-Z-24	189
OM4W	240	PAR38F90	245	WB-5-ZF-24	189
OM5B	240	PSA25	240	WS40	213
OM5W	240	PSA27	240		
OVM7W	240	PSA28	52, 240		
OVP7B	240	PSA29	240		
OVP7W	240	PSA36	240		
P006S	241	PSE26	240		
P100MH	243	PST1B	206		
P012S	241	PST1W	206		