

# 1P AR Back Boxes and Accessories for 20, 30, & 60 A Receptacle Housings

Dimensions see pages 1334–1335

## ARE

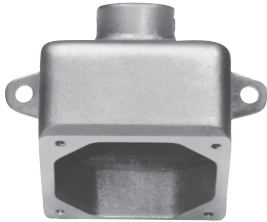

Hub Size	20 / 30 A Cat. #	60 A Cat. #
1/2	ARE13	
3/4	ARE23	
1	ARE33	ARE36
1 1/4		ARE46
1 1/2		ARE56

## ARRC

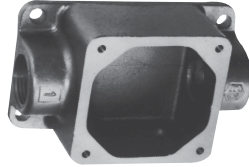

Hub Size	20 / 30 A Cat. #	60 A Cat. #
1/2	ARRC13	
3/4	ARRC23	
1	ARRC33	ARRC36
1 1/4		ARRC46
1 1/2		ARRC56

## AR 15° Angle Adapter



For ARRH and ARRC back boxes

For steel panel or cabinet

Mounts On	Takes AR Receptacle Housings	Cat. #
ARRH and ARRC back boxes	20 and 30 amp.	AR30
ARRH and ARRC back boxes	60 amp.	AR60
Steel panel or cabinet	60, 100 and 150 amp.	AR610

## ARRH

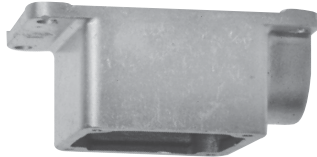

Hub Size	20 / 30 A Cat. #	60 A Cat. #
1/2	ARRH13	
3/4	ARRH23	
1	ARRH33	ARRH36
1 1/4		ARRH46
1 1/2		ARRH56

## ARD



Hub Size	20 / 30 A Cat. #	60 A Cat. #
1/2	ARD13	
3/4	ARD23	
1	ARD33	ARD36
1 1/4		ARD46
1 1/2		ARD56

## Spring Door Assembly



Used With	Cat. #
30 amp, 2, 3 & 4-pole	QE50
60 amp, 2 & 3-pole	QE51
60 amp, 4-pole	QE52
100 and 150 amp, 2 & 3-pole	QE53
100 and 150 amp, 4-pole	QE54

## ARJ

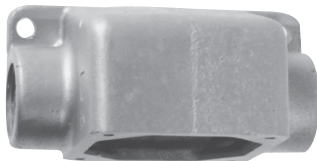

Hub Size	20 / 30 A Cat. #	60 A Cat. #
1/2	ARJ13	
3/4	ARJ23	
1	ARJ33	ARJ36
1 1/4		ARJ46
1 1/2		ARJ56

## ARJG

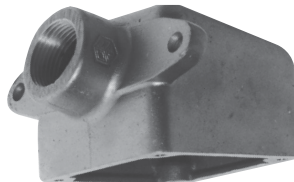

Hub Size	20 / 30 A Cat. #	60 A Cat. #
1/2	ARJG13	
3/4	ARJG23	
1	ARJG33	ARJG36
1 1/4		ARJG46
1 1/2		ARJG56

## Cap and Chain



Used With	Cat. #
30 amp, 2, 3 & 4-pole	QE13
60 amp, 2 & 3-pole	QE32
60 amp, 4-pole	QE34
100 and 150 amp, 2 & 3-pole	QE62
100 and 150 amp, 4-pole	QE64

1P

# AJ and AJC Back Boxes with Angle Adapters for 60, 100, 200 & 400 A Receptacle Housings AJX Assemblies and Component Parts For 200 and 400 A Receptacle Housings

Dimensions  
see pages 1334–1335

1P



AJ Back Box with 60 / 100 / 150 A  
Angle Adapter



AJ Back Box with 200 / 400 A  
Angle Adapter

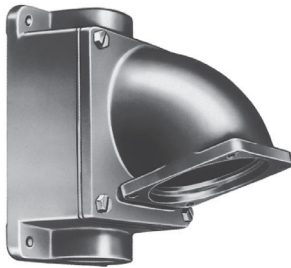

AJC Back Box with 60 / 100 / 150 A  
AJA Angle Adapter



AJC Back Box with 200 A  
Angle Adapter

## AJ and AJC Back Boxes†

Hub Size	Type	60, 100 & 150 A		200 A		400 A	
		Box Only	Box & Adapter Assembly	Box Only	Box & Adapter Assembly	Box Only	Box & Adapter Assembly
1"	One Hub Feed Thru	AJ56* AJC56*	AJ37 AJC37				
1 1/4"	One Hub Feed Thru	AJ56* AJC56*	AJ47 AJC47				
1 1/2"	One Hub Feed Thru	AJ56* AJC56*	AJ57 AJC57	AJ71*	AJ58		
2"	One Hub Feed Thru	AJ66 AJC66	AJ67 AJC67	AJ71*	AJ68	AJ82*	AJ69‡
2 1/2"	One Hub Feed Thru			AJ71* AJC71	AJ78 AJC78	AJ82*	AJ79‡
3"	One Hub Feed Thru					AJ82*	AJ89‡
Angle Adapter		AJA6		AJA1		AJA2	

\*Reducer supplied with assembly.

†AJ and AJC back boxes are square, making it possible to install with hub in several positions.

‡Use AJ69, AJ79 or AJ89 for cables up to 2 – #350MCM, 3 – #300MCM or 4 – #250MCM. For larger cables, use AJX69, etc., listed under assemblies.

## AJX Assemblies Back Box with Angle Adapter, 3 Blank Plates and 1 Hub Plate



Hub Size      400 A  
Cat. #

2	AJX69
2 1/2	AJX79
3	AJX89
3 1/2	AJX929
4	AJX9210
5	AJX9212

## AJX Component Parts

For use in making up assemblies with arrangements of hub plates (4 required) other than those listed.

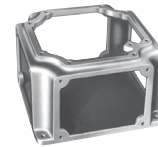

Back Box



Angle Adapter

Type	Cat. #
Back Box 400 A	AJX99
Angle Adapter 400 A	AJ245



Hub Plate



Blank Plate

Hub Size	Hub Plate 400 A Cat. #	Blank Plate 400 A Cat. #
2	YYP96	YYP900
2 1/2	YYP97	
3	YYP98	
3 1/2	YYP99	
4	YYP910	
5	YYP9012	

1P

# 1P Back Boxes

## Dimensions

### Dimensions (In Inches): ARE Back Boxes

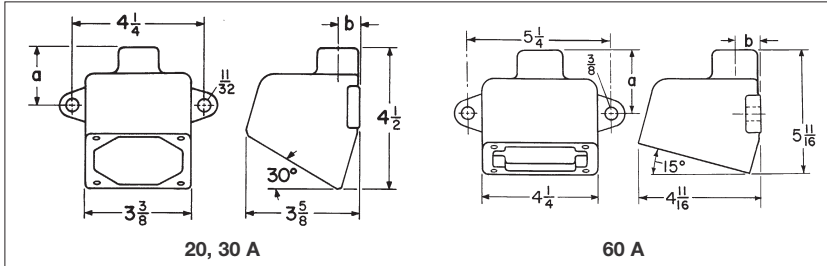

Cat. #	Rating	Size	a	b
13	20, 30 A	1/2	1 <sup>27</sup> / <sub>32</sub>	1 <sup>1</sup> / <sub>16</sub>
23	20, 30 A	3/4	1 <sup>27</sup> / <sub>32</sub>	1 <sup>3</sup> / <sub>16</sub>
33	20, 30 A	1	1 <sup>31</sup> / <sub>32</sub>	1 <sup>5</sup> / <sub>16</sub>
36	60 A	1	2 <sup>9</sup> / <sub>16</sub>	1 <sup>5</sup> / <sub>16</sub>
46	60 A	1 1/4	2 <sup>5</sup> / <sub>8</sub>	1 <sup>3</sup> / <sub>16</sub>
56	60 A	1 1/2	2 <sup>11</sup> / <sub>16</sub>	1 <sup>9</sup> / <sub>16</sub>

### ARJG Back Boxes

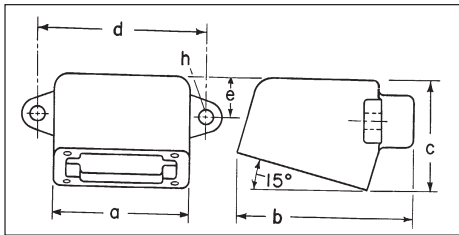

Cat. #	Rating	Size	a	b	c	d	e	h Dia.
13	20, 30 A	1/2	3 <sup>3</sup> / <sub>8</sub>	4 <sup>15</sup> / <sub>32</sub>	2 <sup>3</sup> / <sub>4</sub>	4 <sup>1</sup> / <sub>4</sub>	1 <sup>3</sup> / <sub>8</sub>	1 <sup>1</sup> / <sub>32</sub>
23	20, 30 A	3/4	3 <sup>3</sup> / <sub>8</sub>	4 <sup>15</sup> / <sub>32</sub>	2 <sup>3</sup> / <sub>4</sub>	4 <sup>1</sup> / <sub>4</sub>	1 <sup>3</sup> / <sub>8</sub>	1 <sup>1</sup> / <sub>32</sub>
33	20, 30 A	1	3 <sup>3</sup> / <sub>8</sub>	4 <sup>19</sup> / <sub>32</sub>	2 <sup>3</sup> / <sub>4</sub>	4 <sup>1</sup> / <sub>4</sub>	1 <sup>3</sup> / <sub>8</sub>	1 <sup>1</sup> / <sub>32</sub>
36	60 A	1	4 <sup>1</sup> / <sub>4</sub>	5 <sup>5</sup> / <sub>8</sub>	4 <sup>11</sup> / <sub>16</sub>	5 <sup>1</sup> / <sub>4</sub>	1 <sup>3</sup> / <sub>8</sub>	3 <sup>3</sup> / <sub>8</sub>
46	60 A	1 1/4	4 <sup>1</sup> / <sub>4</sub>	5 <sup>11</sup> / <sub>16</sub>	4 <sup>11</sup> / <sub>16</sub>	5 <sup>1</sup> / <sub>4</sub>	1 <sup>3</sup> / <sub>8</sub>	3 <sup>3</sup> / <sub>8</sub>
56	60 A	1 1/2	4 <sup>1</sup> / <sub>4</sub>	5 <sup>3</sup> / <sub>4</sub>	4 <sup>11</sup> / <sub>16</sub>	5 <sup>1</sup> / <sub>4</sub>	1 <sup>5</sup> / <sub>8</sub>	3 <sup>3</sup> / <sub>8</sub>

### AJ and AJC With 60, 100, 150, 200 and 400 Ampere Angle Adapters

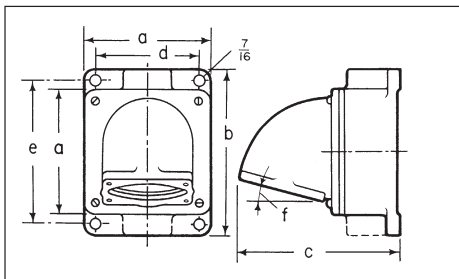

Cat. #	Rating	Size	a	b	c	d	e	f
37, 47, 57	60, 100 A	1, 1 1/4, 1 1/2	5 <sup>5</sup> / <sub>8</sub>	8	7 <sup>7</sup> / <sub>16</sub>	4 <sup>7</sup> / <sub>8</sub>	7	15°
67	60, 100 A	2	5 <sup>7</sup> / <sub>8</sub>	8	8	4 <sup>7</sup> / <sub>8</sub>	7	15°
58, 68, 78	200 A	1 1/2, 2, 2 1/2	8	10 <sup>3</sup> / <sub>4</sub>	9 <sup>7</sup> / <sub>8</sub>	6 <sup>3</sup> / <sub>4</sub>	9 1/2	45°
69, 79, 89	400 A	2, 2 1/2, 3	9	11 <sup>5</sup> / <sub>8</sub>	11 <sup>13</sup> / <sub>16</sub>	7 <sup>3</sup> / <sub>4</sub>	10 <sup>5</sup> / <sub>8</sub>	45°

### AJX Back Body - 400 Amperes

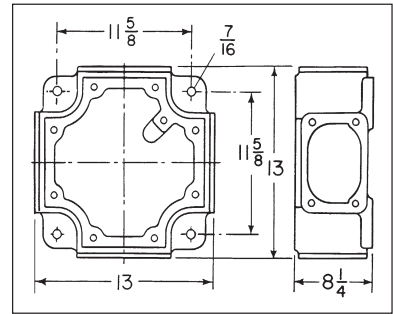

### Hub Plate - 400 Amperes

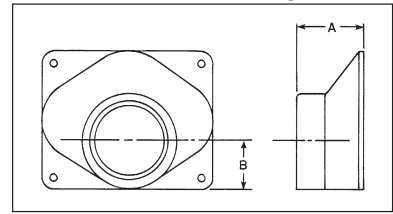

Cat. #	Hub Size	"A"	"B"
YYP96	2	3 <sup>3</sup> / <sub>4</sub>	1 <sup>11</sup> / <sub>16</sub>
YYP97	2 1/2	3 <sup>7</sup> / <sub>8</sub>	2 <sup>5</sup> / <sub>16</sub>
YYP98	3	3 <sup>7</sup> / <sub>8</sub>	2 <sup>5</sup> / <sub>16</sub>
YYP99	3 1/2	3 <sup>7</sup> / <sub>8</sub>	2 <sup>9</sup> / <sub>16</sub>
YYP910	4	3 <sup>7</sup> / <sub>8</sub>	2 <sup>13</sup> / <sub>16</sub>
YYP9012	5	4 <sup>5</sup> / <sub>8</sub>	3 <sup>7</sup> / <sub>16</sub>

### AJ Angle Adapter

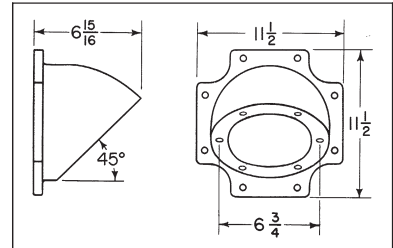

## Dimensions

### ARRC and ARRH Back Boxes

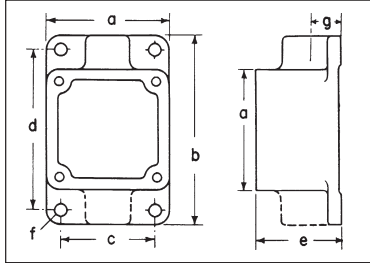

Cat. #	Rating	Size	a	b	c	d	e	f Dia.	g
13	20 / 30 A	1/2	3 3/8	5 5/16	2 5/8	4 9/16	2 1/4	1 1/32	1 1/16
23	20 / 30 A	3/4	3 3/8	5 5/16	2 5/8	4 9/16	2 1/4	1 1/32	1 3/16
33	20 / 30 A	1	3 3/8	5 5/16	2 5/8	4 9/16	2 1/4	1 1/32	1 5/16
36	60 A	1	4 1/4	6 1/2	3 1/2	5 3/4	3 3/8	7/16	1 3/8
46	60 A	1 1/4	4 1/4	6 1/2	3 1/2	5 3/4	3 3/8	7/16	1 3/8
56	60 A	1 1/2	4 1/4	6 1/2	3 1/2	5 3/4	3 3/8	7/16	1 3/8

### AR30 and AR60 Angle Adapters

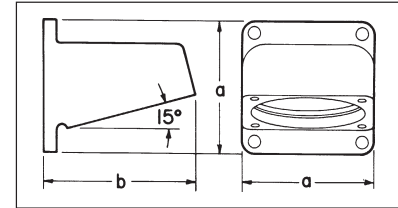

Cat. #	Rating	a	b
AR30	20 / 30 A	3 3/8	4 1/8
AR60	60 A	4 1/4	4 15/16

### AR610 Angle Adapter

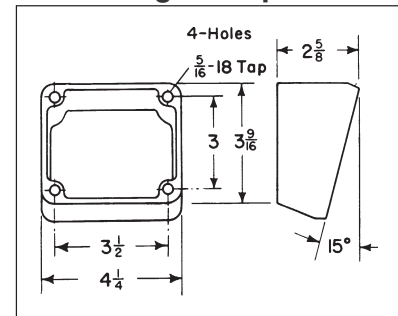

### ARD Back Boxes

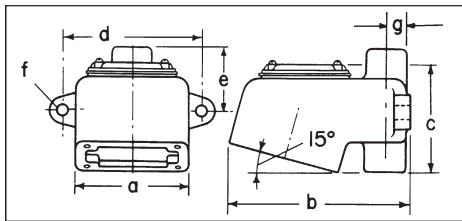

Cat. #	Rating	Size	a	b	c	d	e	f Dia.	g
13	20 / 30 A	1/2	3 3/8	5 5/16	3 23/32	4 1/4	1 27/32	1 1/32	1 1/16
23	20 / 30 A	3/4	3 3/8	5 5/16	3 23/32	4 1/4	1 27/32	1 1/32	1 3/16
33	20 / 30 A	1	3 3/8	5 5/16	3 23/32	4 1/4	1 27/32	1 1/32	1 5/16
36	60 A	1	4 1/4	7 1/16	5 3/4	5 5/8	2 3/4	3/8	1 5/16
46	60 A	1 1/4	4 1/4	7 1/16	5 3/4	5 5/8	2 3/4	3/8	1 5/16
56	60 A	1 1/2	4 1/4	7 1/16	5 3/4	5 5/8	2 3/4	3/8	1 5/16

### ARJ Back Boxes

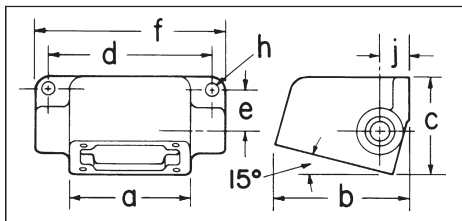

Cat. #	Rating	Size	a	b	c	d	e	f	h Dia.	j
13	20 / 30 A	1/2	3 3/8	3 3/8	2 3/4	4 5/8	1 1/32	5 5/16	1 1/32	1 5/16
23	20 / 30 A	3/4	3 3/8	3 3/8	2 3/4	4 5/8	1 1/32	5 5/16	1 1/32	1 5/16
33	20 / 30 A	1	3 3/8	3 3/8	2 3/4	4 5/8	1 1/32	5 5/16	1 1/32	1 5/16
36	60 A	1	4 1/4	4 11/16	4 11/16	5	1 23/32	6 3/8	3/8	1 5/16
46	60 A	1 1/4	4 1/4	4 11/16	4 11/16	5	1 23/32	6 3/8	3/8	1 5/16
56	60 A	1 1/2	4 1/4	4 11/16	4 11/16	5	1 23/32	6 3/8	3/8	1 5/16