

DESCRIPTION

The SkyRidge™ transforms ambient lighting by perfectly blending a refined modern styling with our breakthrough WaveStream™ LED technology to deliver exceptional performance and superior energy savings. SkyRidge's advanced engineered LED system with superior optical design delivers an unparalleled combination of optimal light uniformity and exceptional efficiency for greater energy savings.

SkyRidge is compatible with all of today's popular ceiling systems and available in a variety of configurations for application versatility. Its perfect balance of form and function make it an ideal choice for commercial office spaces, schools, hospitals, retail and other indoor ambient applications.

SPECIFICATION FEATURES

Construction

Shallow 4.75" deep housing is extruded aluminum frame and injected molded composite end plates. End plates are securely attached with screws for strength and rigidity and the elimination of gaps. End plates have accessory grid-lock feature for safety and convenience. Four auxiliary fixture end suspension points are provided. Large access plate for supply connection.

Controls

Metalux LED luminaires come standard with 0-10V dimming drivers (1% standard).

Options compatible with Eaton's Connected Lighting Systems:

- WaveLinX sensor
- LumaWatt Pro sensor
- SVPD sensor
- DLVP sensor and driver
- Fifth Light DALI driver

Other options include step-dimming and 3rd party drivers. Refer to the Connected Lighting options page and ordering information for more details.

Electrical

Long-life LED system coupled with

electrical driver to deliver optimal performance. LED's available in 3000K, 3500K, 4000K or 5000K with a minimum CRI of 80. Projected life is 100,000 hours at 92% lumen output. Electronic drivers are available for 120-277V applications.

Emergency Battery Pack Option

Optional 120V-277V integral emergency battery pack is available in 7-watts or 14-watts to meet critical life-safety lighting requirements. The 90-minute batteries provide constant power to the LED system, ensuring code-compliance. A test switch/indicator button can be tested safely from the ground using a laser pointer, while the patented EZ Key prevents accidental discharge of the battery during construction. Emergency/generator transfer options available – see ordering information for details.

Driver Access

Drivers can be accessed via plenum.

Finish

Durable frame has high reflectance baked matte white enamel finish for luminous uniformity.

Optics

Catalog #		Type	
Project		Date	
Comments			
Prepared by			

Precision formed optical assembly with positively retained high optical grade acrylic lens provides a directed optical distribution using WaveStream LED technology.

SkyTrim Accessory

Designed for an array of interior applications, SkyTrim is a luminous decorative accent that can be mounted directly on the light guide of a SkyRidge fixture either at the factory or in the field. It is ideal for spaces where color is necessary to provide visual cues, emphasize brand identity, directional awareness or simply as an artistic expression.

Compliance

Components are UL recognized. Indoor luminaires are cULus listed for 25° C ambient environments, RoHS compliant, and comply with IESNA LM-79. LEDs comply with LM-80 standards. DesignLights Consortium® Qualified and classified for DLC Standard, refer to www.designlights.org for details.

Warranty

Five year warranty.



24SR LED

2' X 4' TROFFER LED MODULE

Specification Grade Troffer



CURVED

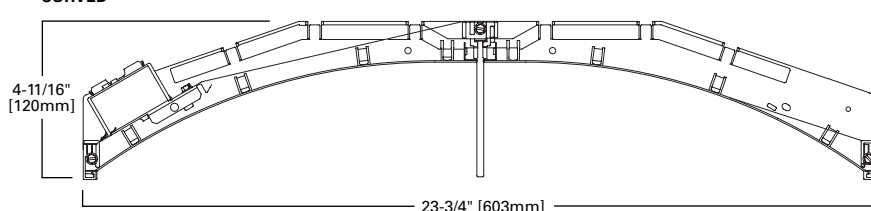

MOUNTING DATA

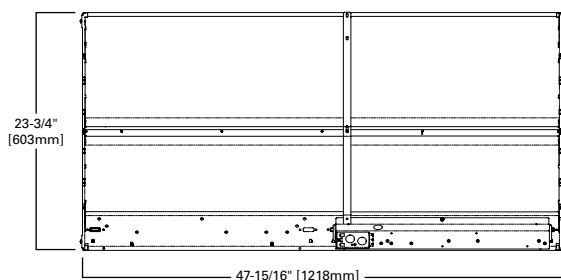

LAMP CONFIGURATIONS

CURVED

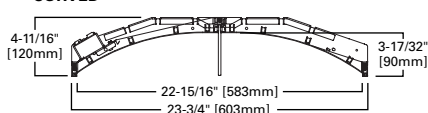

STRAIGHT

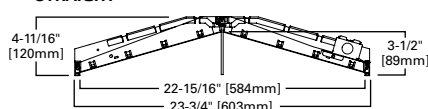

CERTIFICATION DATA

cULus - 1598 and 2043**
 Damp Location Listed
 IC Rated
 LM79/LM80 Compliant
 ROHS Compliant
 DesignLights Consortium® Qualified
 NOM Compliant

*See Drywall Frame Kit Accessory in Ordering Information section.

**Fixture construction is suitable for use in Air-handling and plenum rated spaces in accordance with Section 300.22 (C) of the National Electrical Code, Section 4.3.11.2.6.5 of NFPA 90A and Section 602.2.1.4 of ICC.

LINEAR DISCONNECT

Safe and convenient means of disconnecting power



CEILING COMPATIBILITY

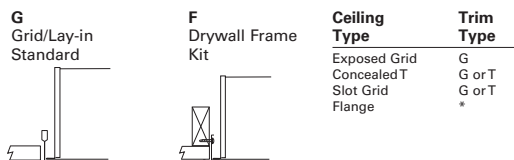

PHOTOMETRICS

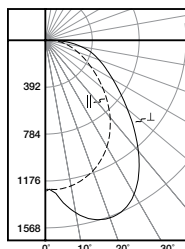

24SR-LD2-39-C-UNV-L835-CD1-U
Electronic Driver
Linear LED 3500K
Spacing criterion: (||) 1.18 x mounting height, (⊥) 1.52 x mounting height
Lumens: 4197
Input Watts: 31.9W
Efficacy: 131.6 lm/W
Test Report: 24SR-LD2-39-C-UNV-L835-CD1-U. IES

Candlepower

Angle	Along	45°	Across ⊥
0	1244	1244	1244
5	1244	1310	1365
10	1223	1396	1485
15	1184	1445	1552
20	1134	1452	1568
25	1066	1418	1534
30	985	1346	1443
35	887	1240	1309
40	784	1112	1148
45	672	979	986
50	560	850	830
55	459	737	700
60	370	638	592
65	292	549	505
70	225	464	424
75	165	381	348
80	112	294	247
85	59	172	135
90	0	0	0

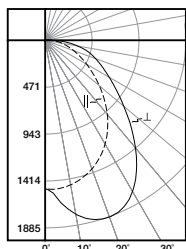

24SR-LD2-48-C-UNV-L835-CD1-U
Electronic Driver
Linear LED 3500K
Spacing criterion: (||) 1.18 x mounting height, (⊥) 1.52 x mounting height
Lumens: 5045
Input Watts: 38.2W
Efficacy: 132.1 lm/W
Test Report: 24SR-LD2-48-C-UNV-L835-CD1-U. IES

Candlepower

Angle	Along	45°	Across ⊥
0	1496	1496	1496
5	1496	1575	1640
10	1470	1678	1785
15	1423	1737	1866
20	1363	1746	1885
25	1282	1704	1844
30	1184	1618	1735
35	1067	1491	1573
40	943	1337	1380
45	808	1177	1186
50	674	1022	998
55	551	886	841
60	445	767	712
65	352	660	607
70	271	558	510
75	198	458	419
80	134	353	296
85	71	207	162
90	0	0	0

Coefficients of Utilization

rc rw RCR	Effective floor cavity reflectance																							
	80%				70%				50%				30%				10%				0%			
	70	50	30	10	70	50	30	10	50	30	10	50	30	10	50	30	10	50	30	10	50	30	10	
0	119	119	119	119	116	116	116	116	111	111	111	106	106	106	102	102	102	100	100	100	100	100	100	
1	108	103	98	94	105	101	96	93	96	93	90	92	89	87	89	86	84	82	82	82	82	82	82	
2	98	89	82	76	95	87	81	75	84	78	74	81	76	72	78	74	70	68	68	68	68	68	68	
3	89	78	70	63	87	77	69	63	74	67	62	71	65	61	68	64	60	57	57	57	57	57	57	
4	82	70	61	54	79	68	60	53	66	58	53	63	57	52	61	56	51	49	49	49	49	49	49	
5	75	62	53	46	73	61	53	46	59	51	46	57	50	45	55	49	45	42	42	42	42	42	42	
6	70	56	47	41	68	55	47	40	53	46	40	52	45	40	50	44	39	37	37	37	37	37	37	
7	65	51	42	36	63	50	42	36	49	41	35	47	40	35	46	40	35	33	33	33	33	33	33	
8	60	46	38	32	59	46	38	32	44	37	32	43	36	32	42	36	31	29	29	29	29	29	29	
9	56	43	34	29	55	42	34	29	41	34	29	40	33	28	39	33	28	26	26	26	26	26	26	
10	53	39	31	26	51	39	31	26	38	31	26	37	30	26	36	30	26	24	24	24	24	24	24	

Coefficients of Utilization

rc rw RCR	Effective floor cavity reflectance																							
	80%				70%				50%				30%				10%				0%			
	70	50	30	10	70	50	30	10	50	30	10	50	30	10	50	30	10	50	30	10	50	30	10	
0	119	119	119	119	116	116	116	116	111	111	111	106	106	106	102	102	102	100	100	100	100	100	100	
1	108	103	98	94	105	101	96	93	96	93	90	92	89	87	89	86	84	82	82	82	82	82	82	
2	98	89	82	76	95	87	81	75	84	78	74	81	76	72	78	74	70	68	68	68	68	68	68	
3	89	78	70	63	87	77	69	63	74	67	62	71	65	61	68	64	60	57	57	57	57	57	57	
4	82	70	61	54	79	68	60	53	66	58	53	63	57	52	61	56	51	49	49	49	49	49	49	
5	75	62	53	46	73	61	53	46	59	51	46	57	50	45	55	49	45	42	42	42	42	42	42	
6	70	56	47	41	68	55	47	40	53	46	40	52	45	40	50	44	39	37	37	37	37	37	37	
7	65	51	42	36	63	50	42	36	49	41	35	47	40	35	46	40	35	33	33	33	33	33	33	
8	60	46	38	32	59	46	38	32	44	37	32	43	36	32	42	36	31	29	29	29	29	29	29	
9	56	43	34	29	55	42	34	29	41	34	29	40	33	28	39	33	28	26	26	26	26	26	26	
10	53	39	31	26	51	39	31	26	38	31	26	37	30	26	36	30	26	24	24	24	24	24	24	

Zonal Lumen Summary

Zone	Lumens	% Fixture
0-30	1159	27.6
0-40	1900	45.3
0-60	3212	76.5
0-90	4197	100.0
0-180	4197	100.0

Luminance Data

Angle in Deg	Average 0-Deg cd/sm	Average 45-Deg cd/sm	Average 90-Deg cd/sm
45	1456	2121	2136
55	1225	1967	1868
65	1060	1990	1828
75	975	2256	2061
85	1033	3023	2367

Zonal Lumen Summary

Zone	Lumens	% Fixture
0-30	1194	27.6
0-40	2284	45.3
0-60	3861	76.5
0-90	5045	100.0
0-180	5045	100.0

Luminance Data

Angle in Deg	Average 0-Deg cd/sm	Average 45-Deg cd/sm	Average 90-Deg cd/sm
45	1750	2549	2568
55	1472	2365	2245
65	1274	2392	2198
75	1173	2713	2478
85	1241	3634	2847

ENERGY AND PERFORMANCE DATA BY CATALOG NUMBER

Stock or MTO*	Catalog Logic (Curved)	Delivered Lumens	Watts	Efficacy (LPW)
MTO	24SR-LD2-29-C-UNV-L830-CD1-U	2982	22.7	131
MTO	24SR-LD2-29-C-UNV-L835-CD1-U	3074	22.7	135
MTO	24SR-LD2-29-C-UNV-L840-CD1-U	3136	22.7	138
MTO	24SR-LD2-29-C-UNV-L850-CD1-U	3413	22.7	150
MTO	24SR-LD2-34-C-UNV-L830-CD1-U	3528	27.2	130
MTO	24SR-LD2-34-C-UNV-L835-CD1-U	3637	27.2	134
MTO	24SR-LD2-34-C-UNV-L840-CD1-U	3710	27.2	136
MTO	24SR-LD2-34-C-UNV-L850-CD1-U	4037	27.2	148
MTO	24SR-LD2-39-C-UNV-L830-CD1-U	4071	31.9	128
Stock	24SR-LD2-39-C-UNV-L835-CD1-U	4197	31.9	132
Stock	24SR-LD2-39-C-UNV-L840-CD1-U	4281	31.9	134
MTO	24SR-LD2-39-C-UNV-L850-CD1-U	4659	31.9	146
MTO	24SR-LD2-45-C-UNV-L830-CD1-U	4596	36.7	125
MTO	24SR-LD2-45-C-UNV-L835-CD1-U	4738	36.7	129
MTO	24SR-LD2-45-C-UNV-L840-CD1-U	4832	36.7	132
MTO	24SR-LD2-45-C-UNV-L850-CD1-U	5258	36.7	143
MTO	24SR-LD2-48-C-UNV-L830-CD1-U	4894	38.2	128
Stock	24SR-LD2-48-C-UNV-L835-CD1-U	5045	38.2	132
Stock	24SR-LD2-48-C-UNV-L840-CD1-U	5146	38.2	135
MTO	24SR-LD2-48-C-UNV-L850-CD1-U	5601	38.2	147
MTO	24SR-LD2-53-C-UNV-L830-CD1-U	5416	43.1	126
MTO	24SR-LD2-53-C-UNV-L835-CD1-U	5584	43.1	130
MTO	24SR-LD2-53-C-UNV-L840-CD1-U	5695	43.1	132
MTO	24SR-LD2-53-C-UNV-L850-CD1-U	6198	43.1	144
MTO	24SR-LD2-59-C-UNV-L830-CD1-U	6026	50.2	120
MTO	24SR-LD2-59-C-UNV-L835-CD1-U	6213	50.2	124
MTO	24SR-LD2-59-C-UNV-L840-CD1-U	6337	50.2	126
MTO	24SR-LD2-59-C-UNV-L850-CD1-U	6896	50.2	137
MTO	24SR-LD2-64-C-UNV-L830-CD1-U	6598	55.5	119
MTO	24SR-LD2-64-C-UNV-L835-CD1-U	6802	55.5	123
MTO	24SR-LD2-64-C-UNV-L840-CD1-U	6938	55.5	125
MTO	24SR-LD2-64-C-UNV-L850-CD1-U	7551	55.5	136

*Made to order (MTO) requires a typical two week lead time.

ENERGY AND PERFORMANCE DATA BY CATALOG NUMBER

Stock or MTO*	Catalog Logic (Straight)	Delivered Lumens	Watts	Efficacy (LPW)
MTO	24SR-LD2-29-S-UNV-L830-CD1-U	2952	22.7	130
MTO	24SR-LD2-29-S-UNV-L835-CD1-U	3043	22.7	134
MTO	24SR-LD2-29-S-UNV-L840-CD1-U	3104	22.7	137
MTO	24SR-LD2-29-S-UNV-L850-CD1-U	3377	22.7	149
MTO	24SR-LD2-34-S-UNV-L830-CD1-U	3491	27.2	128
MTO	24SR-LD2-34-S-UNV-L835-CD1-U	3599	27.2	132
MTO	24SR-LD2-34-S-UNV-L840-CD1-U	3672	27.2	135
MTO	24SR-LD2-34-S-UNV-L850-CD1-U	3995	27.2	147
MTO	24SR-LD2-39-S-UNV-L830-CD1-U	4029	31.9	126
MTO	24SR-LD2-39-S-UNV-L835-CD1-U	4154	31.9	130
MTO	24SR-LD2-39-S-UNV-L840-CD1-U	4237	31.9	133
MTO	24SR-LD2-39-S-UNV-L850-CD1-U	4611	31.9	145
MTO	24SR-LD2-45-S-UNV-L830-CD1-U	4548	36.7	124
MTO	24SR-LD2-45-S-UNV-L835-CD1-U	4688	36.7	128
MTO	24SR-LD2-45-S-UNV-L840-CD1-U	4783	36.7	130
MTO	24SR-LD2-45-S-UNV-L850-CD1-U	5205	36.7	142
MTO	24SR-LD2-48-S-UNV-L830-CD1-U	4844	38.2	127
MTO	24SR-LD2-48-S-UNV-L835-CD1-U	4993	38.2	131
MTO	24SR-LD2-48-S-UNV-L840-CD1-U	5093	38.2	133
MTO	24SR-LD2-48-S-UNV-L850-CD1-U	5542	38.2	145
MTO	24SR-LD2-53-S-UNV-L830-CD1-U	5360	43.1	124
MTO	24SR-LD2-53-S-UNV-L835-CD1-U	5526	43.1	128
MTO	24SR-LD2-53-S-UNV-L840-CD1-U	5636	43.1	131
MTO	24SR-LD2-53-S-UNV-L850-CD1-U	6134	43.1	142
MTO	24SR-LD2-59-S-UNV-L830-CD1-U	5964	50.2	119
MTO	24SR-LD2-59-S-UNV-L835-CD1-U	6149	50.2	122
MTO	24SR-LD2-59-S-UNV-L840-CD1-U	6272	50.2	125
MTO	24SR-LD2-59-S-UNV-L850-CD1-U	6825	50.2	136
MTO	24SR-LD2-64-S-UNV-L830-CD1-U	6530	55.5	118
MTO	24SR-LD2-64-S-UNV-L835-CD1-U	6732	55.5	121
MTO	24SR-LD2-64-S-UNV-L840-CD1-U	6866	55.5	124
MTO	24SR-LD2-64-S-UNV-L850-CD1-U	7472	55.5	135

*Made to order (MTO) requires a typical two week lead time.

LUMEN MAINTENANCE

Ambient Temperature	TM-21 Lumen Maintenance (100,000 hours)	Theoretical L70 (Hours)
25°C	> 92%	> 448,000

Non-IC data

SKYTRIM FIELD INSTALLATION KITS

Color Choice	Kit Catalog Number	Kit Quantity
Tahitian Blue	STK-4-TB-10PK	10
Primary Green	STK-4-PG-10PK	10
Storaro Orange	STK-4-SO-10PK	10
Belladonna Rose	STK-4-BR-10PK	10
Medium Red	STK-4-MR-10PK	10
Pearl	STK-4-PL-10PK	10
Straw	STK-4-ST-10PK	10

Note: Chosen color will be matched on acrylic but will appear lighter once applied to lit light guide.

ORDERING INFORMATION

SAMPLE NUMBER: 24SR-LD2-48-C-UNV-L835-CD1-SVDP1-U

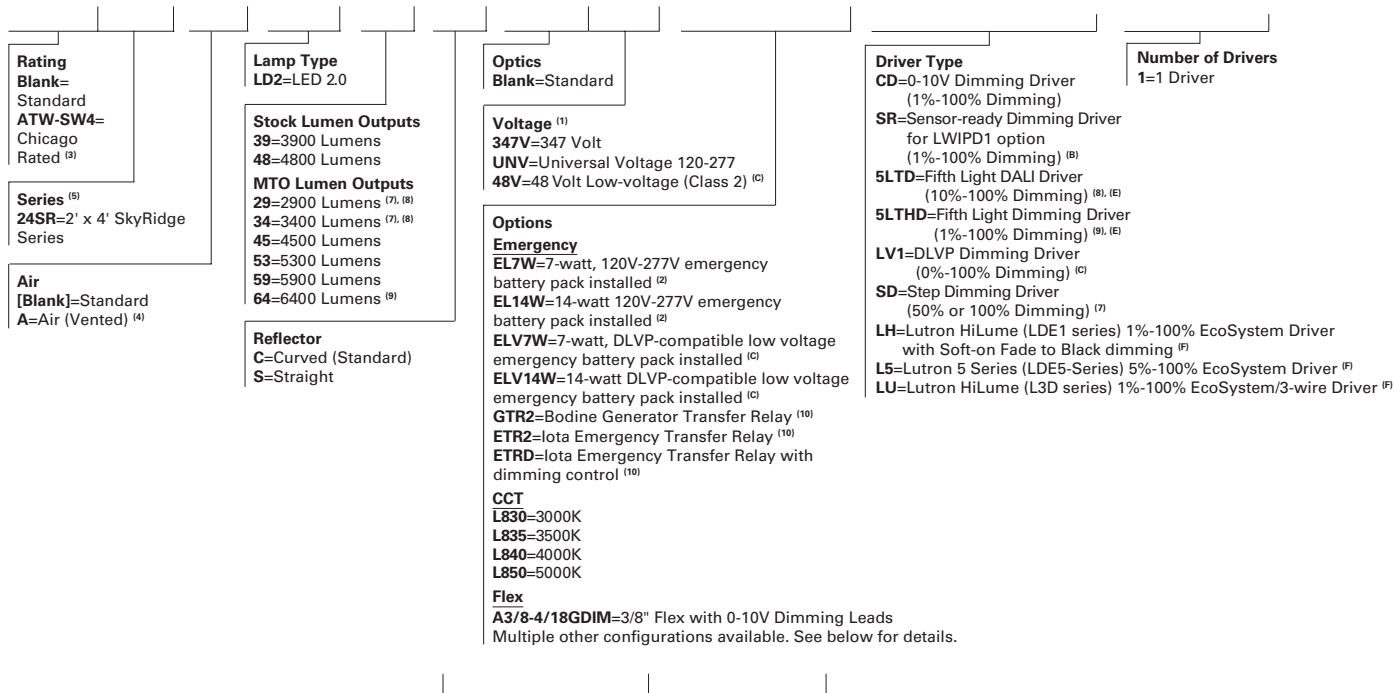

Integrated Sensing Systems
SWPD1=WaveLinX Wireless Integrated Sensor^(A)
LWIPD1=LumaWatt Pro Wireless Integrated Sensor^(B)
LWTPD1=LumaWatt Pro Wireless Tile-mount Sensor^(B)
SLVPD1=DLVP Low-voltage Integrated Sensor^(C)
SVPD1=0-10V Stand-alone Integrated Sensor^(D)



Connected Systems
[CLICK HERE](#)

SkyTrim⁽⁶⁾
TB=Tahitian Blue
PG=Primary Green
SO=Storator Orange
PL=Pearl
BR=Belladonna Rose
MR=Medium Red
ST=Straw

Packaging
U=Unit Pack
PALC=Job Pack, in carton

ACCESSORIES

T3A END E.Q. BRACKET PARTS BAG (Standard with fixture)
DF-24-W=2' x 4' Drywall Frame Kit
SK-24-WT=2' x 4' Tall Surface Mount Kit
DF10P-C_=Decorator Dimmer, 0-10V
SF10P-_=Decorator Slide Dimmer, 0-10V
ISHH-01=Programming Remote for Integrated Sensor^(D)
ISHH-02=Personal Control Remote for Integrated Sensor^(D)

NOTES: ⁽¹⁾Products also available in non-US voltages and frequencies for international markets. ⁽²⁾With integral test switch/indicator/laser test. For approximate delivered lumens multiply the lumens per watt of the desired fixture by the wattage of the emergency battery pack (100 lm/W x 7=700 lumens). IES-format photometry for luminaire under emergency operation available. ⁽³⁾Chicago rated version does not allow for row mounting. ⁽⁴⁾Air version is vented but does not meet air handling requirements. Air version is non-IC. Air version is not available with integrated sensor. ⁽⁵⁾DesignLights Consortium[®] Qualified and classified for DLC Standard, refer to www.designlights.org for details. ⁽⁶⁾Fixtures using factory installed SkyTrim option are not DLC qualified. ⁽⁷⁾2900 and 3400 lumen packages are not available with Step-Dim driver. ⁽⁸⁾2900 and 3400 lumen packages are not available with 5LTD-Dali option driver. ⁽⁹⁾5LTHD option uses two drivers at 6400 lumens. ⁽¹⁰⁾Used to bypass local control during outage. Must be used in conjunction with UL 1008 device (provided by others). GTR2 and ETR2 options include 2 relays on fixtures with dimming drivers. ETRD option only requires one relay when used on a dimming fixture. Must specify voltage as 120V or 277V when ordering these devices.

Integrated Sensing and Control System Options

NOTES: Integrated options must be used in conjunction with the associated system and may not be compatible with other options or accessories. Please refer to the following: ^(A)Consult WaveLinX system pages for additional details and compatibility. ^(B)Consult LumaWatt Pro system pages for additional details and compatibility. ^(C)Consult DLVP system pages for additional details and compatibility. ^(D)Consult SVDP series system pages for additional details and compatibility. ^(E)Consult Fifth Light system pages for additional details and compatibility. ^(F)Consult Marketplace Options - Lutron system pages for additional details and compatibility. Compatible only with driver series shown, and may require two or more drivers. Requires field commissioning to operate or dim. Contact Lutron at www.lutron.com.

Flexible Metal Conduit Options

Flex options available for 0-10V dimming control, DALI dimming control, emergency and night light functions. 72-inch factory-installed and pre-wired to driver, fitted to luminaire housing access plate with 90° enclosed FMC connector. Not all options may be combined and installation ratings vary by type.
A3/8-4/18GDIM series notes: Factory installed dimming option 3/8" flexible metal conduit with 2-#18 power and ground wires and 2-#18 UL-listed jacketed 0-10V +/- control wires. Meets UL 66, 83, 1479, 1569, 1581, 2556. NEC® 250.118, 300.22(C), 392, 396, 330, 501, 502, 503, 530, 504, 505, 518, 520, 530, 645, 72; Federal Specification A-A-59544 (formerly J-C-30B); all applicable OSHA and HUD Requirements. UL Classified 1-, 2-, and 3-hour through penetration with applicable fire stop product (not included). May be surface mounted, fished and/or embedded in plaster. Cable tray and approved raceway rated, install per NEC®; Environmental Air-Handling Space Installation per NEC® 300.22(C).

Specifications & dimensions subject to change without notice. Consult your Eaton Representative for availability and ordering information.

SHIPPING DATA

Catalog No.	Wt.
24SR-LD2-39	24 lbs.
24SR-LD2-48	24 lbs.

INTEGRATED SENSOR

The SkyRidge with Integrated Sensor technology provides automatic energy savings without sacrificing performance. Traditionally, these types of energy savings required coordination between the luminaire and a lighting control system. The SkyRidge delivers superior lighting with integrated occupancy and daylighting controls.

Capture the benefits of traditional lighting controls, without complicated coverage planning or special wiring. Ideal for new construction or retrofit, the SkyRidge delivers automatic ON to an energy saving light level, while ensuring lighting is turned OFF when the space is unoccupied.

The integral daylight sensor reduces the need for special daylight zone planning. Each luminaire will automatically adjust the light level based on reflected light beneath the sensor in a closed loop method.

Occupied daylight light levels and unoccupied light levels can be adjusted using the integrated sensor programming remote (Catalog Number: ISHH-01). The integrated sensor personal remote (Catalog Number: ISHH-02) provides code compliant manual raise, lower, ON, OFF control.

The SkyRidge with Integrated Sensor is easy to install with no special wiring and ensures energy savings out-of-the-box with default control settings.

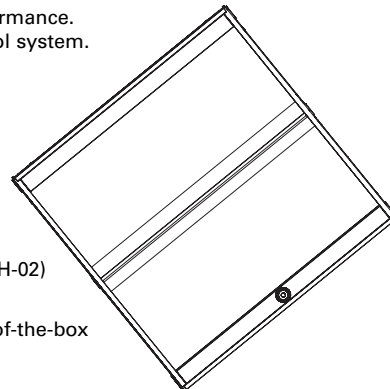

How it works:

- As the user enters the space controlled by the integral sensor, the lighting turns ON to the default daylight level.
- Lighting will remain at that the daylight level until the space is unoccupied. This will start the occupancy timeout period (default 20 minutes).
- If the space remains unoccupied for half of the timeout period, the lighting will automatically reduce to the Energy Saver light level. This adjustable light level is typically half of the occupied daylight level.
- At the end of the timeout period the lighting will go to the unoccupied light level. This adjustable light level uses the OFF default setting.

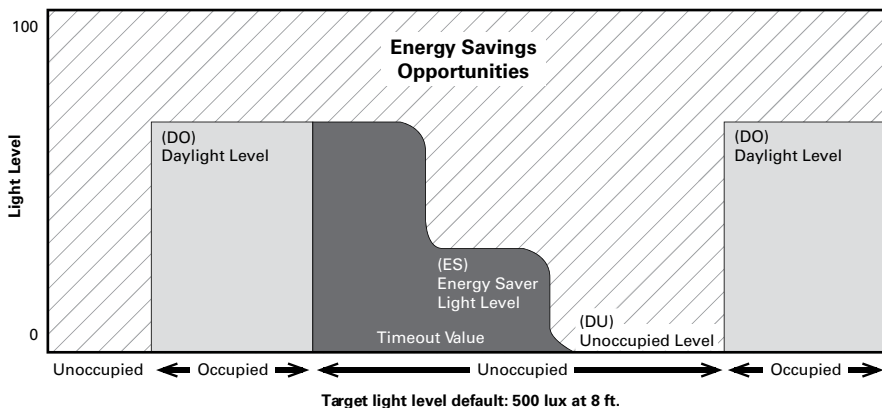

Coverage

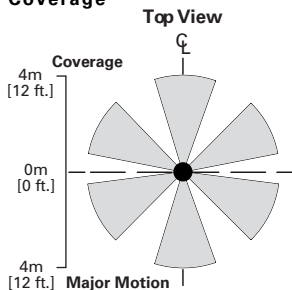

Side View

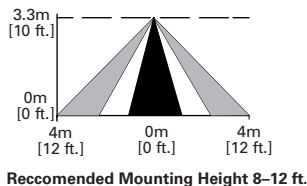

Optional Remote Controls



ISHH-01 Programming Remote



ISHH-02 Personal Control Remote