

DESCRIPTION

The M Series combines a low profile, surface modular design with the latest in energy-efficient technology. The dihedral recessed top design allows for cooler fixture operation. Other features include a die-formed housing, surface or stem mounting (single or continuous row), full seam-welded corners and a broad selection of attractive door frames.

The versatile modular M Series can be the perfect solution when used in applications such as commercial office spaces, schools, hospitals, and retail merchandising.

SPECIFICATION FEATURES

Construction

Housing Die formed code gauge prime cold rolled steel. Smooth sides permit flush joint for continuous row mounting. Full seam welded corners. Dihedral recessed top design insures cooler ballast operation. Die formed captive lampholder bracket fully encloses wiring permitting easy lampholder replacement. Ballast covers easily removed without tools.

Electrical*

Ballasts are CBM/ETL Class "P" and are positively secured by mounting bolts. Pressure lock lampholders. UL/CUL listed. Suitable for damp locations.

Finish

Painted after fabrication. Electrostatically applied baked white polyester powder enamel finish. Multistage cleaning cycle, iron phosphate coating with rust inhibitor. Conveyorized application and baking timing accurately controlled at an elevated temperature.

Hinging/Latching

Positive cam action steel latches with baked white enamel finish. Safety lock T-hinges allow hinging and latching either side.

Frame/Shielding

Die formed, heavy gauge, flat steel door. Baked white enamel finish. Reinforced, mitered door frame corners. Door frame quadrasealed to prevent light spillage. Light stabilized 100% virgin acrylic prismatic shielding. Standard #12 pattern. Optional shielding available.



2M
232
432

2' X 4' SURFACE
2 OR 4 LAMPS

Surface Modular

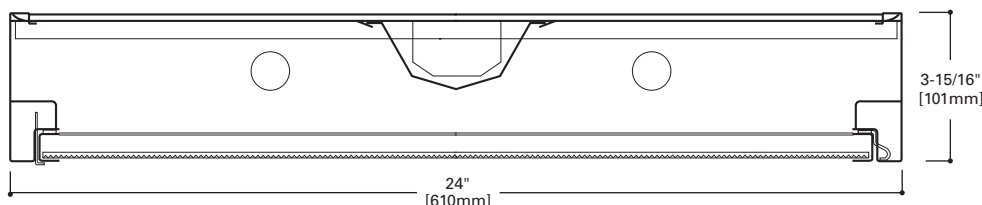

MOUNTING DATA

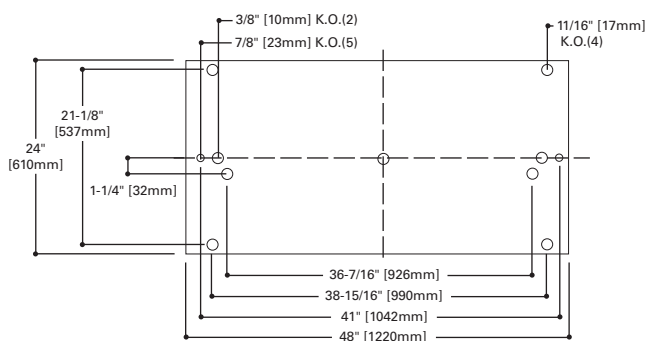

STEM MOUNTING METHODS

Consult Pre Sales Technical Support for Continuous Row Application

Fixture Application

4 Point Suspension

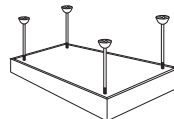

LAMP CONFIGURATIONS

2 LAMP

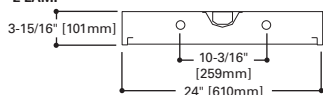

4 LAMP

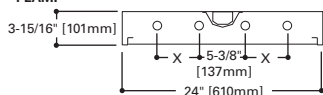

DOOR FRAMES

2M

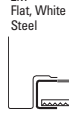

2MXF

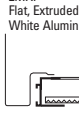

2MSR



2MXR



2MXRD



ENERGY DATA

Input Watts:

EB Ballast & STD Lamps

232 (61)

432 (122)

Luminaire Efficacy Rating

LER = FL-71

Catalog Number: 2M-432A

Yearly Cost of 1000 lumens, 3000 hrs at .08 KWH = \$3.38

*Reference the lamp/ballast data in the Technical Section for specific lamp/ballast requirements.

LAMPS CONTAIN MERCURY. DISPOSE ACCORDING TO LOCAL, STATE OR FEDERAL LAWS

LINEAR DISCONNECT

Safe and convenient means of disconnecting power.

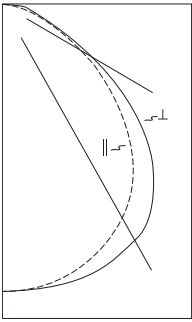

2M-432A125
Energy Saving
Ballast

F32T8/35K Lamps
2900 Lumens

Spacing criterion:
(||) 1.3 x mounting
height, (⊥) 1.4 x
mounting height

Efficiency 77.2%

Test Report:
2M432A125.IES

LER = FL-71

Yearly Cost of 1000
lumens, 3000 hrs at
.08 KWH = \$3.38

Coefficients of Utilization

| rc | Effective floor cavity reflectance | | | | | | | | 20% | | | | | | | | | | | | | | | | | |
|------------|------------------------------------|----|----|----|-----|----|----|----|-----|----|----|----|-----|----|----|----|-----|----|----|----|----|----|----|----|----|----|
| | 80% | | | | 70% | | | | 50% | | | | 30% | | | | 10% | | | | 0% | | | | | |
| rw | 70 | 50 | 30 | 10 | 70 | 50 | 30 | 10 | 50 | 30 | 10 | 50 | 30 | 10 | 50 | 30 | 10 | 50 | 30 | 10 | 50 | 30 | 10 | 0 | | |
| RCR | | | | | | | | | | | | | | | | | | | | | | | | | | |
| 0 | 92 | 92 | 92 | 92 | 90 | 90 | 90 | 90 | 86 | 86 | 86 | 82 | 82 | 82 | 79 | 79 | 79 | 77 | 77 | 77 | 77 | 77 | 77 | 77 | 77 | 77 |
| 1 | 85 | 82 | 79 | 76 | 83 | 80 | 78 | 75 | 77 | 75 | 73 | 74 | 72 | 71 | 71 | 70 | 69 | 67 | 67 | 67 | 67 | 67 | 67 | 67 | 67 | 67 |
| 2 | 79 | 73 | 68 | 65 | 77 | 72 | 67 | 64 | 69 | 65 | 62 | 66 | 64 | 61 | 64 | 62 | 60 | 58 | 58 | 58 | 58 | 58 | 58 | 58 | 58 | 58 |
| 3 | 73 | 65 | 60 | 55 | 71 | 64 | 59 | 55 | 62 | 58 | 54 | 60 | 56 | 53 | 58 | 55 | 52 | 51 | 51 | 51 | 51 | 51 | 51 | 51 | 51 | 51 |
| 4 | 67 | 59 | 52 | 48 | 65 | 58 | 52 | 47 | 56 | 51 | 47 | 54 | 50 | 46 | 52 | 49 | 46 | 44 | 44 | 44 | 44 | 44 | 44 | 44 | 44 | 44 |
| 5 | 61 | 52 | 46 | 41 | 60 | 51 | 45 | 41 | 50 | 44 | 40 | 48 | 44 | 40 | 47 | 43 | 40 | 38 | 38 | 38 | 38 | 38 | 38 | 38 | 38 | 38 |
| 6 | 57 | 47 | 41 | 36 | 55 | 46 | 40 | 36 | 45 | 39 | 35 | 44 | 39 | 35 | 43 | 38 | 35 | 33 | 33 | 33 | 33 | 33 | 33 | 33 | 33 | 33 |
| 7 | 52 | 42 | 36 | 31 | 51 | 42 | 36 | 31 | 41 | 35 | 31 | 39 | 35 | 31 | 38 | 34 | 31 | 29 | 29 | 29 | 29 | 29 | 29 | 29 | 29 | 29 |
| 8 | 48 | 38 | 32 | 27 | 47 | 37 | 31 | 27 | 36 | 31 | 27 | 36 | 30 | 27 | 35 | 30 | 27 | 25 | 25 | 25 | 25 | 25 | 25 | 25 | 25 | 25 |
| 9 | 44 | 34 | 28 | 24 | 43 | 34 | 28 | 23 | 33 | 27 | 23 | 32 | 27 | 23 | 31 | 27 | 23 | 22 | 22 | 22 | 22 | 22 | 22 | 22 | 22 | 22 |
| 10 | 41 | 31 | 25 | 21 | 40 | 31 | 25 | 21 | 30 | 24 | 21 | 29 | 24 | 21 | 28 | 24 | 20 | 19 | 19 | 19 | 19 | 19 | 19 | 19 | 19 | 19 |

Zonal Lumen Summary

| Zone | Lumens | %Lamp | %Fixture |
|-------|--------|-------|----------|
| 0-30 | 2747 | 23.7 | 30.7 |
| 0-40 | 4554 | 39.3 | 50.8 |
| 0-60 | 7620 | 65.7 | 85.1 |
| 0-90 | 8958 | 77.2 | 100.0 |
| 0-180 | 8958 | 77.2 | 100.0 |

Typical VCP Percentages

| Room Size (Ft.) | Height Along | | Height Across | |
|-----------------|--------------|-------|---------------|-------|
| | 8.5' | 10.0' | 8.5' | 10.0' |
| 20 x 20 | 58 | 62 | 56 | 60 |
| 30 x 30 | 52 | 56 | 51 | 54 |
| 30 x 60 | 44 | 47 | 42 | 45 |
| 60 x 30 | 54 | 58 | 53 | 57 |
| 60 x 60 | 44 | 47 | 43 | 45 |

Candela

| Angle | Along | 45° | Across ⊥ |
|-------|-------|------|----------|
| 0 | 3426 | 3426 | 3426 |
| 5 | 3415 | 3419 | 3427 |
| 10 | 3369 | 3393 | 3422 |
| 15 | 3296 | 3351 | 3407 |
| 20 | 3192 | 3288 | 3376 |
| 25 | 3057 | 3200 | 3318 |
| 30 | 2889 | 3083 | 3230 |
| 35 | 2676 | 2928 | 3062 |
| 40 | 2410 | 2674 | 2787 |
| 45 | 2098 | 2313 | 2462 |
| 50 | 1725 | 1853 | 2041 |
| 55 | 1333 | 1443 | 1584 |
| 60 | 1019 | 1065 | 1171 |
| 65 | 765 | 727 | 813 |
| 70 | 550 | 475 | 578 |
| 75 | 400 | 353 | 429 |
| 80 | 280 | 290 | 307 |
| 85 | 146 | 165 | 162 |
| 90 | 0 | 0 | 0 |

ORDERING INFORMATION

SAMPLE NUMBER: 2M-432A-120V-EB81-U

| | | | | |
|---|---|---|---|--|
| <p>Width 2=2' Width, 1' Width (3 Lamp)</p> <p>Series ^{(1), (2)} M=Modular Surface Mount</p> <p>Door Frame Standard=Flat White Steel Door (Leave Blank) FA=Flush White Extruded Aluminum c/w Spring Latch RA=Regressed White Extruded Aluminum FAN=Flush Natural Anodized Extruded Aluminum RAN=Regressed Natural Anodized Extruded Aluminum FAB=Flush Black Extruded Aluminum RAB=Regressed Black Extruded Aluminum</p> | <p>Number of Lamps ⁽³⁾ 2=2 Lamps 3=3 Lamps 4=4 Lamps (Not Included)</p> <p>Wattage (Length) 32=32WT8 (48")</p> <p>Lens A=#12 Pattern Acrylic (Standard) A125=#12 Pattern Acrylic (.125" Thick) A19/156=#19 Pattern Acrylic (.156" Thick) PB1S=Silver Parabolic Louver</p> | <p>Voltage ⁽⁴⁾ 120=120V 277=277V 347=347V UNV=Universal Voltage 120-277V ⁽⁵⁾</p> <p>Options GL=Single Element Fuse GM=Double Element Fuse Emergency=Emergency Installed</p> | <p>Ballast Type EB8_=T8 Electronic Start. Total Harmonic Distortion < 10% EB8_/PLUS=T8 Electronic Start. Total Harmonic Distortion < 10%. High Ballast Factor > 1.15. ER8_=T8 Electronic Program Rapid Start. Total Harmonic Distortion < 10% High Performance T8 Ballasts HB8_=T8 Electronic Instant Start. Total Harmonic Distortion < 10%. Standard Ballast Factor .86 - .88 HB8_L=T8 Electronic Instant Start. Total Harmonic Distortion < 10%. Low Ballast Factor .77 - .82 HB8_N=T8 Electronic Instant Start. Total Harmonic Distortion < 10%. Normal Ballast Factor 1.0 HB8_H=T8 Electronic Instant Start. Total Harmonic Distortion < 10%. High Ballast Factor 1.15 - 1.20 HR8_=T8 Electronic Program Rapid Start. Total Harmonic Distortion < 10%. Standard Ballast Factor .86 - .88 HR8_DIM=T8 Electronic Program Rapid Start. Total Harmonic Distortion < 10%. Step Dimming. Ballast Factor .88 HR8_L=T8 Electronic Program Rapid Start. Total Harmonic Distortion < 10%. Low Ballast Factor .71 - .79 HR8_H=T8 Electronic Program Rapid Start. Total Harmonic Distortion < 10%. High Ballast Factor 1.15 - 1.20</p> | <p>Options VRS=Vandal Resistant ⁽⁶⁾ EKO=End Plate with 7/8" KO (Required for Continuous Row Mounting) ⁽⁷⁾</p> <p>Packaging U=Unit Pack</p> |
|---|---|---|---|--|

NOTES: ⁽¹⁾2' x 2', 2' x 4' require 4-point suspension, side mounted ballast recommended. ⁽²⁾Full seam welded corners on 1' x 4', 2' x 2', 2' x 4' fixtures. ⁽³⁾1' x 4' 3-lamp, 2' x 4' 3-lamp have side mounted ballasts covers. ⁽⁴⁾Products also available in non-US voltages and frequencies for international markets. ⁽⁵⁾Not available when specifying emergencies, voltage must be specific. ⁽⁶⁾Available on flat doors only. ⁽⁷⁾For continuous row mounting 7/8" KOs furnished in end of fixture, specify EKO.

Specifications & dimensions subject to change without notice. Consult your Cooper Lighting Representative for availability and ordering information.

ACCESSORIES

(Order Separately)
SCF=Fixed Stem Set (Specify Length)
SCS=Swivel Stem Set (Specify Length)
SCA=Adjustable 48" Stem Set

(Additional Accessories Available. See Options and Accessories Section.)

SHIPPING DATA

| Catalog No. | Wt. |
|-------------|---------|
| 2M-232A | 32 lbs. |
| 2M-432A | 36 lbs. |

Number of Ballasts
1=1 Ballast
2=2 Ballasts