

D10 Expert™ – Analog and Discrete Outputs

Advanced sensor for use with plastic fiber optics

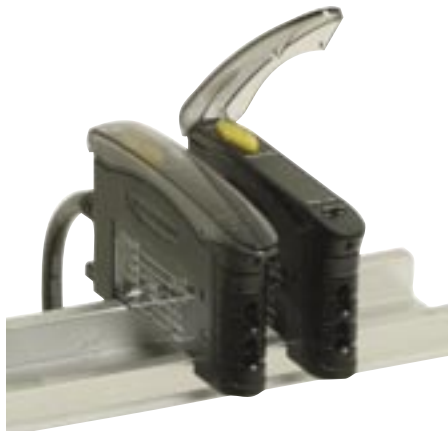

Features

- Easy-to-set automatic *Expert*-style TEACH options* including static, dynamic, and single-point programming plus manual adjustment for fine-tuning
- 16-bit microcontroller and 12-bit Analog-to-Digital converter for high-performance, low-contrast sensing
- Easy-to-read 4-digit display for TEACH and signal strength readout, plus indicators for a continuous readout of operating status (user configurable)
- Models available with one scalable Analog output (4-20 mA or 0-10V) and one Discrete output (PNP or NPN)
- Four-mode power and speed selection with automatic cross-talk avoidance circuitry
- Selectable OFF-delay options
- Gate input wire can be used to selectively inhibit sensor outputs from switching
- Models available with visible red (680 nm) or visible green (525 nm) sensing beam
- Models available with 2 m or 9 m (6.5' or 30') cable or integral Pico-style quick-disconnect
- Sleek, ultra-slim 10 mm housing, mounts to a standard 35 mm DIN rail

* U.S. Patent #5,808,296

Models

Models		Cables*	Discrete Outputs	Analog Output
Red Beam	Green Beam			
D10INFP	D10INFPG	2 m (6.5') Cable	NPN	4-20 mA
D10INFPQ	D10INFPGQ	6-pin Pico-style QD		
D10IPFP	D10IPFPG	2 m (6.5') Cable	PNP	
D10IPFPQ	D10IPFPGQ	6-pin Pico-style QD		
D10UNFP	D10UNFPG	2 m (6.5') Cable	NPN	0-10V
D10UNFPQ	D10UNFPGQ	6-pin Pico-style QD		
D10UPFP	D10UPFPG	2 m (6.5') Cable	PNP	
D10UPFPQ	D10UPFPGQ	6-pin Pico-style QD		

* 9 m (30') cables are available by adding suffix "W/30" to the model number of any cabled sensor (e.g., **D10INFP W/30**).
A model with a QD connector requires a mating cable (see page 15).



WARNING . . . Not To Be Used for Personnel Protection

Never use these products as sensing devices for personnel protection. Doing so could lead to serious injury or death.

These sensors do NOT include the self-checking redundant circuitry necessary to allow their use in personnel safety applications. A sensor failure or malfunction can cause either an energized or de-energized sensor output condition. Consult your current Banner Safety Products catalog for safety products which meet OSHA, ANSI and IEC standards for personnel protection.

D10 Expert™ Analog and Discrete Outputs

Overview

The D10 Expert Sensor is a high-performance plastic fiber-optic sensor whose many configuration (TEACH-mode) options make it suitable for demanding applications. Even with all its features, it is extremely easy to use. Advanced 16-bit microcontroller technology makes this possible.

The D10 Expert provides high-performance sensing in low-contrast applications. Expert TEACH and setup options provide static, dynamic and single-point programming plus manual fine adjustment, remote programming and push button lockout. Its slender, stylized housing has a large digital display visible beneath a clear cover for easy programming and status monitoring during operation. The sensor mounts directly to standard 35 mm DIN rail or using the supplied mounting bracket.

The sensor features two outputs with independent setpoints: one of two analog choices, depending on model, and one discrete (NPN or PNP, also depending on model). Built-in crosstalk avoidance protocol provides trouble-free operation for multiple sensors in one area.

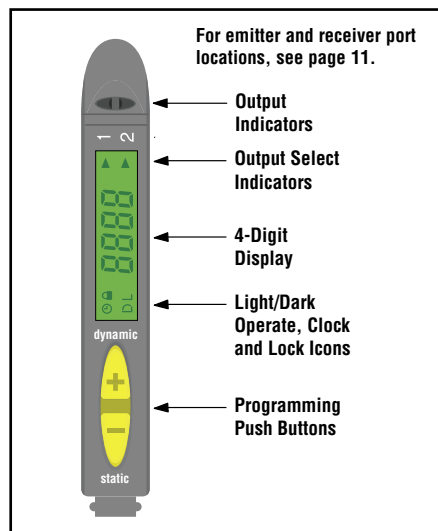

Figure 1. D10 features

Programming Options

Light/Dark Operate Selection	Toggle to select the condition for which each output will conduct: when the target is present or when the target is absent.								
OFF-Delay Timing Selection	Programmable OFF-delay pulse stretcher: 0, 2, 5, 10, 15, 20, 30, 40, 60, 80, or 100 milliseconds Analog Outputs: OFF-delay acts as a smoothing function								
Display Selection	Discrete Output: Raw signal value or % excess signal Analog Output: Raw signal value or analog value (0-10V dc or 4-20 mA)								
Power Level/Speed Selection	Super High-Speed (SHS)		High-Speed (HS)		High-Power (HP)		Super High-Power (SHP)		
Response*	50 µs		200 µs		1 ms		2.5 ms		
Repeatability	25 µs		50 µs		75 µs		100 µs		
Maximum Range*	Fiber	Red 680 nm	Green 525 nm	Red 680 nm	Green 525 nm	Red 680 nm	Green 525 nm	Red 680 nm	Green 525 nm
	PIT16U	20 mm	9 mm	30 mm	9 mm	55 mm	13 mm	90 mm	16 mm
	PIT26U	100 mm	40 mm	150 mm	40 mm	250 mm	55 mm	400 mm	70 mm
	PIT46U	300 mm	100 mm	550 mm	100 mm	1000 mm	160 mm	1200 mm	180 mm
	PIT66U	600 mm	180 mm	1000 mm	180 mm	1700 mm	280 mm	2400 mm	320 mm
	PBT16U	6 mm	**	10 mm	**	18 mm	3 mm	30 mm	3.5 mm
	PBT26U	30 mm	12 mm	50 mm	12 mm	100 mm	20 mm	150 mm	25 mm
	PBT46U	100 mm	30 mm	175 mm	30 mm	250 mm	42 mm	300 mm	60 mm
PBT66U	175 mm	55 mm	250 mm	55 mm	400 mm	80 mm	475 mm	100 mm	
Tracking Feature	Sets Output 2 to identical settings as Output 1; Output 2 settings can then be revised as desired. (See Advanced Setup procedure, page 11.)								
Factory Default Settings	The following settings are preset at the factory; revert sensor to factory defaults using Advanced Setup procedure (page 11). <ul style="list-style-type: none"> • Light operate (L) • No OFF-delay (t 0) • Raw signal value (1234) • Output 1 displayed • High Speed (HS); 200 µs response • Maximum power setting • Analog: full scale • Discrete: switchpoint positioned at middle of range 								

* Diffuse mode performance based on 90% reflectance white test card.

** ø0.010" bifurcated fiber not recommended in these speed settings. Contact Banner Applications for more information.

Sensor Programming

Programming Procedures

Two push buttons, Dynamic (+) and Static (-), may be used to access and set programming parameters. For remote programming, connect a switch or digital input to the gray wire; length of the individual pulses is equal to the value T:

$$0.04 \text{ seconds} \leq T \leq 0.8 \text{ seconds}$$

Returning to RUN mode

TEACH and SETUP modes each may be exited in one of two ways: by exercising the 60-second time-out, or by cancelling out of the process. In TEACH mode, the sensor will return to RUN mode without saving any of the new settings; in SETUP mode, the sensor will return to RUN mode but save all of the settings. To cancel out of TEACH mode, press and hold the Static (-) button for 2 seconds; to cancel out of SETUP mode, press and hold both the Static (-) and Dynamic (+) buttons for 2 seconds.

Output 2

The setpoint(s) for each output can be set independently of one another. However, the functional range available for output 2 is dictated by the automatic power and gain settings established for output 1. Whenever output 1 is taught, output 2 also must be retaught. Applications hint: teach the weakest signal on output 1 first.

Dynamic TEACH and Adaptive Thresholds

Dynamic TEACH is used to program sensitivity during actual machine run conditions. During Dynamic TEACH, the sensor takes multiple samples of the light and dark conditions and automatically sets the sensitivity at the optimum level. For the discrete output, Dynamic TEACH activates the sensor's adaptive threshold system, which continuously tracks minimum and maximum signal levels, and automatically maintains centering of the switch point between the light and dark conditions. The adaptive threshold system remains in effect during RUN mode to automatically adjust for changes in the light or the dark conditions.

When Dynamic TEACH mode is used to program sensitivity, the output ON state (light or dark operate) will remain as it was last programmed. To change to either light or dark operate, use the SETUP mode (see page 9).

Sensitivity may be adjusted at any time when the sensor is in RUN mode by clicking the "+" and "-" buttons. However, when a manual adjustment is made, the adaptive threshold system is disabled (cancelled).

D10 Expert™ Analog and Discrete Outputs

Analog Outputs

Output 1 is configured for either 4 to 20 mA or 0 to 10V dc analog output, depending on the model. The sensor may be programmed using the two-point TEACH (either static or dynamic) or single-point static teach.

Teaching two setpoints (static or dynamic): The sensor sets the first taught condition to the highest output level (either 20 mA or 10V), and the second taught condition to the lowest level (either 4 mA or 0V), and scales between these points. If the first condition taught has more returned light, the sensor will be in Light Operate mode (LO). If the first taught condition is darker, the sensor will be in Dark Operate mode (DO). To change the slope of the analog output (refer to Figure 2), toggle LO/DO in Setup (page 9).

Single-point (static) Teach: The sensor sets the taught condition to the mid-point of its range (12 mA or 5V, depending on the model). For Light Operate mode, the sensor will automatically scale up to 20 mA (or 10V) for maximum light condition (the maximum possible received signal) and down to 4 mA (or 0V) for maximum dark condition (no signal), and vice-versa for Dark Operate mode. To change the slope of the analog output (refer to Figure 3), toggle LO/DO in Setup (page 9).

An OFF-delay enabled for the analog output acts as an averaging function. During the OFF-delay period, the sensor will take multiple analog readings and average the result before changing the analog value. This acts to reduce the effects of major spikes in the analog system, in effect “smoothing” the output reading.

NOTE: Depending on the application configuration and fibers used, the analog function may or may not behave linearly. The received light intensity will be dictated by the inverse square properties of light.

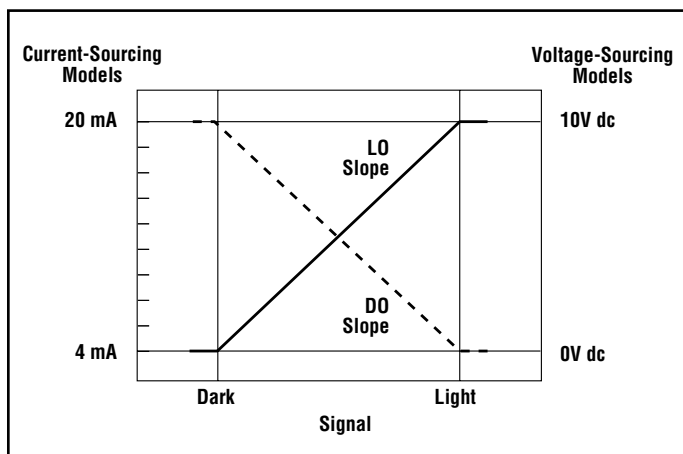

Figure 2. Analog output as a function of target position – two setpoints (static or dynamic)

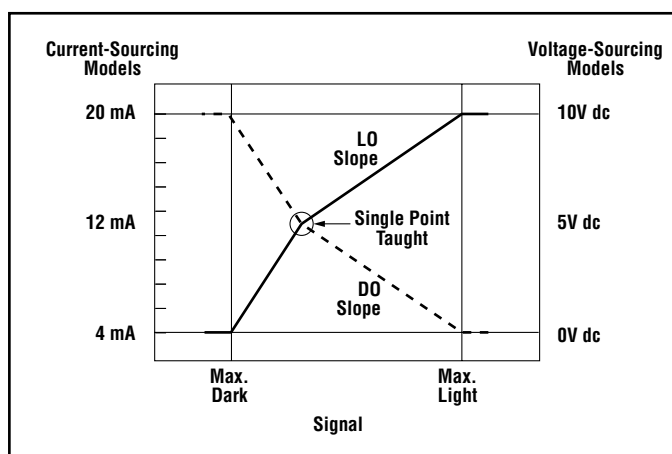

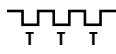



Figure 3. Analog output as a function of target position – single-point TEACH

D10 Expert™ Analog and Discrete Outputs

Active Channel Select







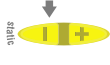

- Selects which channel to teach
- Displays channel configuration information.

Active Channel Select	Push Button	Remote 0.04 sec. ≤ T ≤ 0.8 sec.	Result
	<ul style="list-style-type: none"> • Single-click both buttons simultaneously. 	<ul style="list-style-type: none"> • Triple-pulse the remote line. 	<p>Pointer icon: moves to the other channel indicator.</p> 

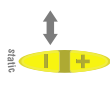
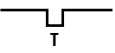
D10 Expert™ Analog and Discrete Outputs

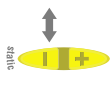
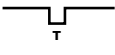
Static TEACH

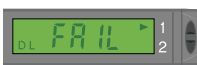





- Two-point TEACH to set a single threshold.
- Threshold is adjustable using the “+” and “-” buttons (see Manual Adjust, page 8).

	Push Button	Remote 0.04 sec. ≤ T ≤ 0.8 sec.	Result										
Access Static TEACH Mode	<ul style="list-style-type: none"> • Press and hold Static (-) button. 	<ul style="list-style-type: none"> • No action required; sensor is automatically ready for 1st TEACH condition. 	<ul style="list-style-type: none"> • Display flashes “1st” • Arrow icon turns red 										
Teach Output ON Condition	<ul style="list-style-type: none"> • Present Output ON target. • Click Static button. 	<ul style="list-style-type: none"> • Present Output ON target. • Single-pulse the remote line. 	<ul style="list-style-type: none"> • Display flashes “2nd” 										
Teach Output OFF Condition	<ul style="list-style-type: none"> • Present Output OFF target. • Click Static button. 	<ul style="list-style-type: none"> • Present Output OFF target. • Single-pulse the remote line. 	<p>TEACH conditions acceptable:</p> <ul style="list-style-type: none"> • Display flashes “pass,” followed by a number (denoting contrast); see table below. <table border="1" data-bbox="917 955 1177 1144"> <thead> <tr> <th colspan="2">Contrast Values</th> </tr> </thead> <tbody> <tr> <td>500+</td> <td>Excellent</td> </tr> <tr> <td>100 - 500</td> <td>Good</td> </tr> <tr> <td>32 - 99</td> <td>Low</td> </tr> <tr> <td>0 - 31</td> <td>Marginal</td> </tr> </tbody> </table> <ul style="list-style-type: none"> • Sensor returns to RUN mode with new settings. • Arrow icon turns green <p>TEACH conditions unacceptable:</p> <ul style="list-style-type: none"> • Display flashes “fail” and returns to “1st” • Arrow icon remains red • After 60 seconds, sensor returns to RUN mode (Arrow icon turns green) without changing settings.   	Contrast Values		500+	Excellent	100 - 500	Good	32 - 99	Low	0 - 31	Marginal
Contrast Values													
500+	Excellent												
100 - 500	Good												
32 - 99	Low												
0 - 31	Marginal												

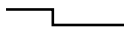
D10 Expert™ Analog and Discrete Outputs

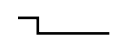
Dynamic TEACH

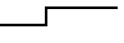





- TEACH on-the-fly.
- Sets a single threshold.
- Threshold is adjustable using the “+” and “-” buttons (see Manual Adjust, page 8).

	Push Button	Remote	Result										
Access Dynamic TEACH Mode	<ul style="list-style-type: none"> • Press and hold Dynamic (+) button. 	<ul style="list-style-type: none"> • Hold remote line low (to ground). 	<ul style="list-style-type: none"> • Display flashes “dyn” • Arrow icon turns red 										
Teach Sensing Conditions	<ul style="list-style-type: none"> • Present Output ON/OFF conditions while continuing to hold Dynamic button. 	<ul style="list-style-type: none"> • Present Output ON/OFF conditions while continuing to hold remote line low (to ground) 											
Return to RUN Mode	<ul style="list-style-type: none"> • Release Dynamic button. 	<ul style="list-style-type: none"> • Release remote line/switch. 	<p>TEACH conditions acceptable:</p> <ul style="list-style-type: none"> • Display flashes “pass,” followed by a number (denoting contrast); see table below. <table border="1"> <thead> <tr> <th colspan="2">Contrast Values</th> </tr> </thead> <tbody> <tr> <td>500+</td> <td>Excellent</td> </tr> <tr> <td>100 - 500</td> <td>Good</td> </tr> <tr> <td>32 - 99</td> <td>Low</td> </tr> <tr> <td>0 - 31</td> <td>Marginal</td> </tr> </tbody> </table> <ul style="list-style-type: none"> • Sensor returns to RUN mode with new settings. • Arrow icon turns green  <p>TEACH conditions unacceptable:</p> <ul style="list-style-type: none"> • Display flashes “fail” • Arrow icon remains red • Sensor returns to RUN mode (Arrow icon turns green) without changing settings. 	Contrast Values		500+	Excellent	100 - 500	Good	32 - 99	Low	0 - 31	Marginal
Contrast Values													
500+	Excellent												
100 - 500	Good												
32 - 99	Low												
0 - 31	Marginal												

D10 Expert™ Analog and Discrete Outputs

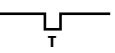

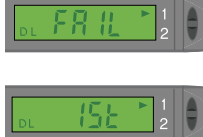

Single-Point Static TEACH

- Used to set a single ON condition.
- All other conditions (both lighter and darker) will result in an OFF output.
- Target ON condition sensitivity is adjustable using the “+” and “-” buttons (see Manual Adjust, below).

	Push Button	Remote 0.04 sec. ≤ T ≤ 0.8 sec.	Result
Access TEACH Mode	<ul style="list-style-type: none"> • Press and hold Static (-) button. 		<ul style="list-style-type: none"> • Display flashes “1st” • Arrow icon turns red 
		<ul style="list-style-type: none"> • Present target to learn. • Single-pulse the remote line. 	<ul style="list-style-type: none"> • Display flashes “2nd” • Arrow icon turns red 
Teach Setpoint (Output ON) Condition	<ul style="list-style-type: none"> • Present target to learn. • Double-click the Static button. 	<ul style="list-style-type: none"> • Double-pulse the remote line. 	<p>TEACH conditions acceptable:</p> <ul style="list-style-type: none"> • Display flashes “sngl.” then “pt” twice • Sensor returns to RUN mode with new settings. • Arrow icon turns green  <p>TEACH conditions unacceptable:</p> <ul style="list-style-type: none"> • Display flashes “fail” and returns to “1st” • Arrow icon remains red • After 60 seconds, sensor returns to RUN mode (Arrow icon turns green) without changing settings. 

Manual Adjust











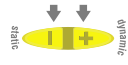







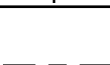

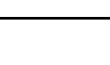
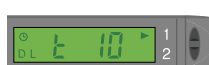

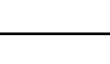
- May be used at any time sensor is in RUN mode.
- Fine-tunes the sensing thresholds or adjusts sensitivity to the single-point target conditions.

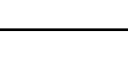
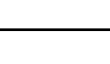
	Push Button	Remote	Result
Manual Adjust	<ul style="list-style-type: none"> • Click “+” to increase, or click “-” to decrease. 	<ul style="list-style-type: none"> • Not available with remote programming. 	<ul style="list-style-type: none"> • Display briefly flashes the threshold setpoint value as it is being changed.  <p>or</p>  <ul style="list-style-type: none"> • Display flashes “inc” or “dec” as single-point tolerance is adjusted. <p>or</p> 

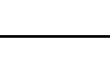
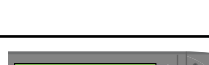
D10 Expert™ Analog and Discrete Outputs

Sensor Setup



- Configures sensor display and operating parameters.
- Changes are updated instantly.
- Click Dynamic (+) or double-pulse remote line to select an option.
- Click Static (-) or single-pulse remote line to advance.

	Push Button	Remote 0.04 sec. ≤ T ≤ 0.8 sec.	Result
Access SETUP Mode	<ul style="list-style-type: none"> • Press and hold both buttons concurrently. 	<ul style="list-style-type: none"> • Double-pulse the remote line. 	<ul style="list-style-type: none"> • Arrow icon turns red
Select Light/Dark Operate	<ul style="list-style-type: none"> • Click Dynamic to toggle between selections. 	<ul style="list-style-type: none"> • Double-pulse remote line to toggle between selections. 	Light Operate: <ul style="list-style-type: none"> • Display flashes "lo" • L icon 
	<ul style="list-style-type: none"> • Click Static to save selection and advance to "OFF-Delay." 	<ul style="list-style-type: none"> • Single-pulse the remote line to save selection and advance to "OFF-Delay." 	Dark Operate: <ul style="list-style-type: none"> • Display flashes "do" • D icon 
Select OFF-Delay Timing Enable	<ul style="list-style-type: none"> • Click Dynamic to toggle between selections. 	<ul style="list-style-type: none"> • Double-pulse the remote line to toggle between selections. 	OFF (No OFF-Delay): <ul style="list-style-type: none"> • "t 0" • Clock icon OFF 
	<ul style="list-style-type: none"> • Click Static to save selection and advance to "Display." 	<ul style="list-style-type: none"> • Single-pulse the remote line to save selection and advance to "Display." 	2 to 100 ms OFF-Delay: <ul style="list-style-type: none"> • "t 2," "t 5," "t 10," "t 15," "t 20," "t 30," "t 40," "t 60," "t 80," or "t100" • Clock icon ON 
Select Display Parameters	<ul style="list-style-type: none"> • Click Dynamic (+) to toggle between selections. 	<ul style="list-style-type: none"> • Double-pulse the remote line to toggle between selections. 	Raw signal value: <ul style="list-style-type: none"> • 1234 
	<ul style="list-style-type: none"> • Click Static (-) to save selection and advance to "Power/Speed." 	<ul style="list-style-type: none"> • Single-pulse the remote line to save selection and advance to "Power/Speed." 	Percent of excess signal: <ul style="list-style-type: none"> • 123P 
Select Power and Speed Combination	<ul style="list-style-type: none"> • Click Dynamic (+) to toggle between selections. 	<ul style="list-style-type: none"> • Double-pulse the remote line to toggle between selections. 	Super-high-speed (50-μs response) <ul style="list-style-type: none"> • SHS 
	<ul style="list-style-type: none"> • Click Static (-) to save selection and return to RUN mode. 	<ul style="list-style-type: none"> • Single-pulse the remote line to save selection and return to RUN mode. 	High-speed (200-μs response) <ul style="list-style-type: none"> • HS 
			High-power (1-ms response) <ul style="list-style-type: none"> • HP 
			Super-high-power (2.5-ms response) <ul style="list-style-type: none"> • SHP 

D10 Expert™ Analog and Discrete Outputs

Push Button Lockout

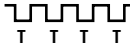









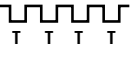

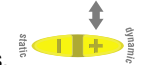

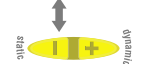

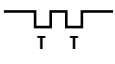

- Prevents unwanted adjustments or tampering of the push buttons.
- Push buttons can be enabled or disabled only from the remote line and only during normal RUN mode.

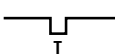
	Push Button	Remote 0.04 sec. ≤ T ≤ 0.8 sec.	Result
Enable or Disable Push Buttons	<ul style="list-style-type: none"> • Not available with push-button programming. 	<ul style="list-style-type: none"> • From RUN mode, quad-pulse the remote line to toggle between selections. 	<p>Push Buttons Disabled:</p> <ul style="list-style-type: none"> • Display flashes “loc” • Padlock icon appears • Sensor remains in RUN mode  <p>Push Buttons Enabled:</p> <ul style="list-style-type: none"> • Display flashes “uloc” • Padlock icon disappears • Sensor remains in RUN mode 

D10 Expert™ Analog and Discrete Outputs

Advanced Setup

- Advanced adjustments to previously configured sensor display and operating parameters.
- Quad-click Static (-) or quad-pulse remote line before exiting “Power and Speed” settings to enter this mode.
- Click Dynamic (+) or double-pulse remote line to select an option.
- Click Static or single-pulse remote line to advance.
- Changes are updated instantly.

	Push Button	Remote 0.04 sec. ≤ T ≤ 0.8 sec.	Result
Enter SETUP Mode	<ul style="list-style-type: none"> • From “Power and Speed” mode, quad-click Static (-) button. 	<ul style="list-style-type: none"> • From “Power and Speed” mode, quad-click the remote line. 	<ul style="list-style-type: none"> • Arrow icon remains red • Display shows “Tracking Enabled” option. 
Track Enable	<ul style="list-style-type: none"> • Click Dynamic (+) to toggle between selections. 	<ul style="list-style-type: none"> • Double-pulse the remote line to toggle between selections. 	<p>Sets output 2 identical to output 1</p> <p>Tracking disabled:</p> <ul style="list-style-type: none"> • Display shows “tr n” 
	<ul style="list-style-type: none"> • Click Static (-) to save selection and advance to “Factory Default.” 	<ul style="list-style-type: none"> • Single-pulse the remote line to save selection and advance to “Factory Default.” 	<p>Tracking enabled:</p> <ul style="list-style-type: none"> • Display shows “tr y” 
Factory Default Settings	<ul style="list-style-type: none"> • Click Dynamic (+) to toggle between selections. 	<ul style="list-style-type: none"> • Double-pulse the remote line to toggle between selections. 	<p>Returns to factory default factory settings</p> <p>Factory Default Settings Not Selected:</p> <ul style="list-style-type: none"> • Display shows “fd n” 
	<ul style="list-style-type: none"> • Click Static (-) to advance to “Display Orientation.” 	<ul style="list-style-type: none"> • Single-pulse the remote line to advance to “Display Orientation.” 	<p>Factory Default Settings Selected:</p> <ul style="list-style-type: none"> • Display shows “fd y” 
Display Orientation	<ul style="list-style-type: none"> • Click Dynamic (+) to toggle between selections. 	<ul style="list-style-type: none"> • Double-pulse the remote line to toggle between selections. 	<p>Inverts display to read “upside-down”</p> <p>Normal:</p> <ul style="list-style-type: none"> • For example: 1234 
	<ul style="list-style-type: none"> • Click Static (-) to return to RUN mode. 	<ul style="list-style-type: none"> • Single-pulse the remote line to return to RUN mode. 	<p>Inverted:</p> <ul style="list-style-type: none"> • For example: 4821 NOTE: Icons do not invert. 

D10 *Expert*™ Analog and Discrete Outputs

Self-Diagnostic Error Modes

In the unlikely event that the setup parameters are lost or become corrupt, the display will continuously scroll: “USEr PSF Error.” Reteach the sensor to recover. If the problem persists, contact your Banner representative for further information.

Gate Input

The pink wire is configured as a gate input. When this wire is pulled low (i.e., to the sensor ground), it inhibits the outputs from switching, while all other sensor functions continue to be enabled. This feature is useful for controlling when the outputs are allowed to change states. Gate input function response time is 1 millisecond.

D10 Expert™ Analog and Discrete Outputs

Specifications

Required Fiber-Optic Cable	Banner P-Series plastic fibers		
Sensing Beam	Visible red, 680 nm, or Visible green, 525 nm, depending on model		
Supply Voltage and Current	4-20 mA Analog Models: 12 to 24V dc (10% maximum ripple) at less than 65 mA, exclusive of load 0-10V dc Analog Models: 15 to 24V dc (10% maximum ripple) at less than 70 mA, exclusive of load		
Supply Protection Circuitry	Protected against reverse polarity and transient voltage		
Output Configuration	2 independently configurable outputs, depending on model: NPN w/analog (4-20 mA or 0-10V) or PNP w/analog (4-20 mA or 0-10V)		
Output Rating	Discrete Output: 150 mA, max. load OFF-state leakage current: < 10 µA at 24V dc ON-state saturation voltage: NPN < 1.5V dc at 150 mA PNP < 2.5V dc at 150 mA	Analog Output: 4-20 mA or 0-10V dc Load: 4-20 mA Models: 100Ω max. impedance 0-10V dc Models: 1 MΩ min. impedance	
Output Protection Circuitry	Protected against false pulse on power-up and continuous short-circuit		
Output Response Time	Discrete Output: Programmable, 50 microseconds, 200 microseconds, 1 millisecond, 2.5 milliseconds Analog Output: 1 millisecond NOTE: < 1 second delay on power-up; outputs do not conduct during this time.		
Adjustments	Push-button or remote programming of response time, OFF-delay, light/dark operate, and display		
Indicators	Four-digit digital display plus LED indicators for active channel, push-button lockout, OFF-delay and light/dark operate selection; 2 yellow output indicators		
Construction	Black ABS/polycarbonate alloy (UL94 V-0 rated) housing, clear polycarbonate cover		
Environmental Rating	NEMA 1, IEC IP50		
Connections	PVC-jacketed 2 m or 9 m (6.5' or 30') 6-wire integral cable or integral 6-pin Pico-style quick-disconnect		
Operating Conditions	Temperature: -20° to +55°C (-4° to +131°F) Storage Temperature: -20° to +80°C (-4° to +175°F) Max. Rel. Humidity: 90% @ 50°C (non-condensing)		
	Number of Devices, Stacked	Ambient Temperature Rating	Load Specification
	3	55°C	150 mA
	7	50°C	50 mA
10	45°C	50 mA	
Installation	35 mm DIN rail or included mounting bracket		
Certifications			

D10 Expert™ Analog and Discrete Outputs

Dimensions

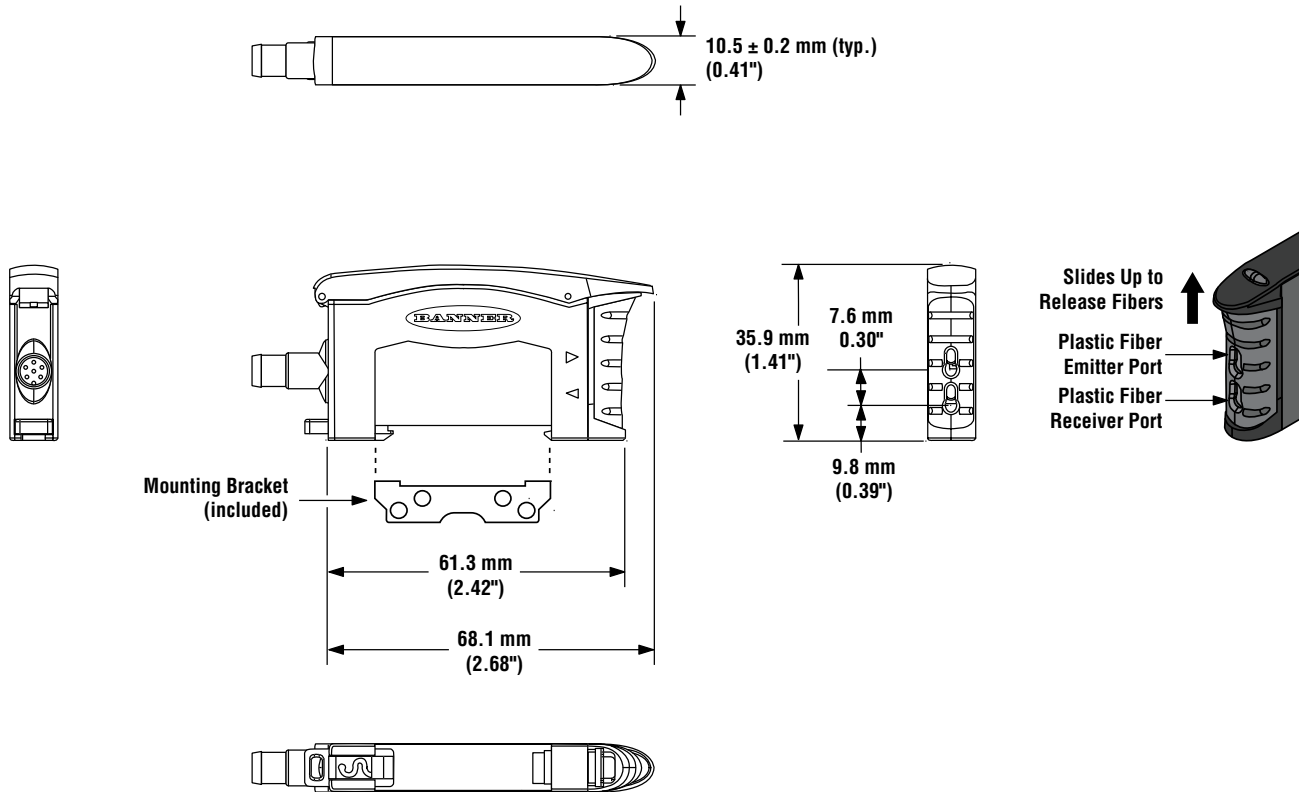

Included Bracket Dimensions

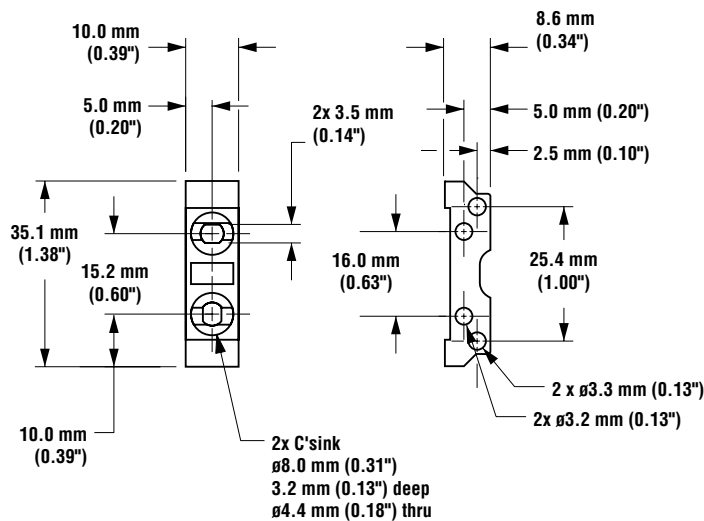

M3 Hardware included:
 Lock Washer (2)
 Flat Washer (2)
 Screws (2)
 Hex Nuts (2)

D10 Expert™ Analog and Discrete Outputs

Hookups

NPN, 4-20 mA Output Models

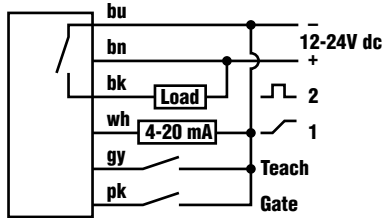

NPN, 0-10V dc Output Models

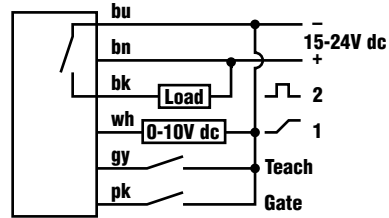

PNP, 4-20 mA Output Models

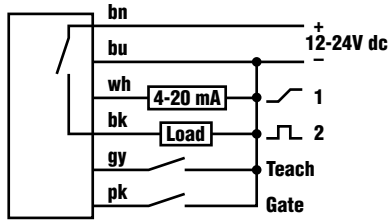

PNP, 0-10V dc Output Models

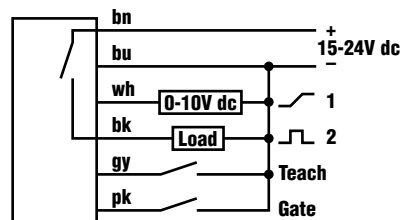

NOTE: QD hookups are functionally identical.

Accessories

Pico-Style Quick-Disconnect Cables

Cable: PUR jacket, polyurethane connector body, POM snap-lock coupling

Conductors: 26 or 24 AWG high-flex stranded, gold-plated contacts

Temperature: -40° to +90°C (-40° to +194°F)

Voltage Rating: 30V ac/36V dc

Style	Model	Length	Dimensions	Pin-out
6-Pin Straight	PKG6Z-2	2 m (6.5')		
	PKG6Z-9	9 m (30')		
6-Pin Right-angle	PKW6Z-2	2 m (6.5')		
	PKW6Z-9	9 m (30')		

D10 *Expert*™ Analog and Discrete Outputs



more sensors, more solutions

WARRANTY: Banner Engineering Corp. warrants its products to be free from defects for one year. Banner Engineering Corp. will repair or replace, free of charge, any product of its manufacture found to be defective at the time it is returned to the factory during the warranty period. This warranty does not cover damage or liability for the improper application of Banner products. This warranty is in lieu of any other warranty either expressed or implied.