



TRAC 12/25

Project: _____

Fixture Type: _____

Location: _____

Contact/Phone: _____

Miniature 25-Amp Low Voltage Trac System TRAC SECTIONS, FEEDS, JOINERS AND PENDANT MOUNTINGS TLVR

PRODUCT DESCRIPTION

Miniature, single-circuit trac sections for operation with 12 volt or 24 volt step down transformers as listed on pages [D3.1.2](#), [D3.1.3](#), [D3.1.5](#) (except TL546). Each trac section is supplied with dead end and is compatible with electrical feeds, joiner connectors and accessories as listed on this spec sheet, to permit NEC code-compliant installations. Accepts all Trac12 cove, accent and pendant lampholders.

PRODUCT SPECIFICATIONS

Construction Extruded "1" beam channel aluminum for maximum strength • Injection molded polycarbonate dead-end with set screw
• Standard lengths may be cut-to-length by installer.

Electrical Two 10 gauge solid copper conductors • Rated 25 amps at 12 or 24 volts.

Labels UL listed, CSA certified.

Specifications subject to change without notice.

DIMENSIONS

Surface Mounted Trac 12/25

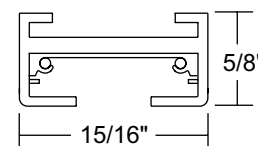
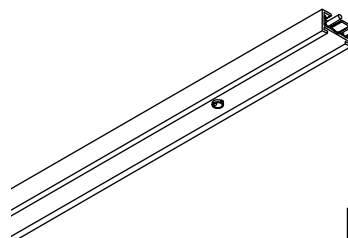

PRODUCT INSTALLATION

Supplied with toggle bolts for surface mounting • Use with system components listed below to complete trac system.

ORDERING INFORMATION

Example: TLVR 8FT WH

Series	Length	Finish
TLVR Trac 12/25 Track Sections	2FT 2-foot track section; actual length 20-5/8"	BL Black WH White
	4FT 4-foot track section; actual length 44-5/8"	
	6FT 6-foot track section; actual length 68-5/8"	
	8FT 8-foot track section; actual length 92-5/8"	

Joiner Connectors (12V or 24V)

TLR20 BL, SL, WH	TLR23 BL, SL, WH	TLR24 BL, SL, WH	TLR28 BL, SL, WH
<p>Accordion Adjustable Joiner</p> <p>Joins two trac sections at variable angles to left, right, up or down. Includes two terminal block connectors, joiner wires and covers.</p>	<p>Miniature Straight Connector</p> <p>Joins two trac sections end-to-end. Includes terminal block joiner and cover.</p>	<p>Adjustable Connector</p> <p>Joins two trac sections to form a 90-degree corner or straight coupling. Includes two terminal block connectors, joiner wires and covers.</p>	<p>Dead End</p> <p>Use on extra field-cut trac sections.</p>

TRAC 12/25

Miniature 25-Amp Low Voltage Trac System TRAC SECTIONS, FEEDS, JOINERS AND PENDANT MOUNTINGS TLVR

Electrical Feeds (12V or 24V)

Examples: TLR21 BL, TLR36TB

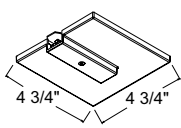
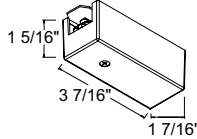
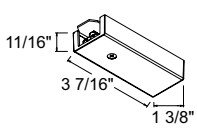
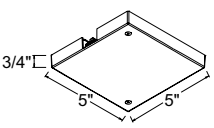
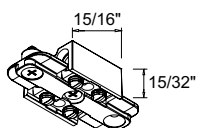
TLR21	TLR34	TLR38	TLR36	TLR36TB
BL, SL, WH	BL, SL, WH	BL, SL, WH	BL, SL, WH	BL, WH
<p>End Feed Connector and Outlet Box Cover</p> <p>Allows trac to be fed via remote transformer from an outlet box. Includes terminal block and mounting plate cover.</p> 	<p>End Feed Connector and Conduit Feed</p> <p>Allows trac to be fed via remote transformer with conduit through the end or top using standard 1/2" electrical connectors. Includes terminal block feed connector, mounting plate and cover.</p> 	<p>End Feed Connector</p> <p>Allows trac to be fed via remote transformer from top using standard electrical connectors. Includes terminal block connector, mounting plate and cover.</p> 	<p>Outbox/T-Bar Ceiling Canopy</p> <p>Mounts over outlet boxes or on T-Bar ceiling to feed up to 4 tracs via a remote transformer. Includes one TLR36TB, mounting plate and cover. To feed more than one trac, order additional TLR36TB connectors. Requires TLR37 for T-bar installation.</p> 	<p>Terminal Block</p> <p>Terminal block for TLR36.</p> 

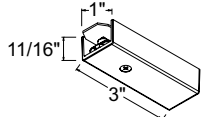
TLR50
BL, SL, WH
<p>Pendant Feed End Connector</p> <p>For use in conjunction with TLR90/91 Pendant Stem or TLR96 Cable Feed assemblies to feed power into end of trac. Includes terminal block connector, support plate and cover.</p> 

Accessories

TLR37	TLR37916
BL, WH	BL, WH
<p>15/16" T-Bar Attachment Clip</p> <p>To attach Trac 12/25 to inverted tee ceilings using flush or drop tiles. Use one for every 4' of Trac 12/25 trac.</p>	<p>9/16" T-Bar Attachment Clip</p> <p>To attach Trac 12/25 to inverted tee ceilings using flush or drop tiles. Use one for every 4' of Trac 12/25 trac.</p>
	

Trac 12 Extension Wands

TLRW
12IN, 18IN, 24IN, 36IN, 48IN
BL, SL, WH
<p>Trac 12 Extension Wands</p> <p>Suspend Trac 12 lampholders from Trac 12 or Trac 12/25 trac sections or monopoints.</p> 

TRAC 12/25

Miniature 25-Amp Low Voltage Trac System TRAC SECTIONS, FEEDS, JOINERS AND PENDANT MOUNTINGS TLVR

Connectors/Mountings

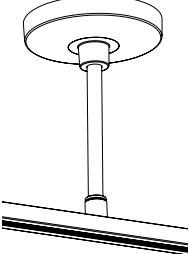
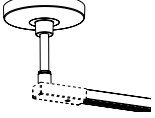
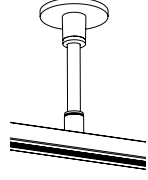
TLR90	TLR91	TLR92
12IN, 18IN, 24IN, 36IN, 48IN	12IN, 18IN, 24IN, 36IN, 48IN	12IN, 18IN, 24IN, 36IN, 48IN
BL, SL, WH	BL, SL, WH	BL, SL, WH
<p>T-Bar Pendant Stem Kit</p> <p>For feed and/or support use. Includes full-size canopy, pendant stem, T-Bar plate with 15/16" T-bar clip and Trac mounting hardware. Feed requires TLR50 Pendant End Feed Connector.</p> 	<p>Junction Box Pendant Stem Kit</p> <p>For feed and/or support use. Includes full-size canopy, pendant stem, outlet box strap and Trac mounting hardware. Feed requires TLR50 Pendant End Feed Connector.</p> 	<p>Pendant Stem Mechanical Support Kit</p> <p>Suspends Trac 12/25 from T-bar ceilings or drywall. Includes Mini-Canopy, pendant stem, 15/16" T-bar clip, drywall anchor and Trac mounting hardware.</p> 

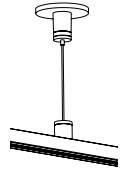
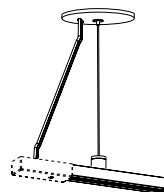
TLR95	TLR96
48IN, 144IN	48IN, 144IN
BL, SL, WH	BL, SL, WH
<p>Stainless Steel Cable Mechanical Support Kit</p> <p>Suspends Trac 12/25 from T-bar ceilings or drywall. Includes Mini-Canopy, steel cable, 15/16" T-bar clip, drywall anchor and Trac mounting hardware.</p> 	<p>Stainless Steel Cable Feed & Mechanical Support</p> <p>Includes full-size feed/support canopy, steel cable, 10 gauge stranded tandem wire, outlet box strap and Trac mounting hardware. Feed requires TLR50.</p> 

For all Trac12/25 mounting accessories, use any combination of two for 2', 4' or 6' trac sections or three for 8' trac section. Stainless steel cable recommended only for trac patterns, not straight runs.