



INSTALLATION INSTRUCTIONS

TRAC 12 AND TRAC 12/25

FOR JUNO TLR37 / TLR37916 T-BAR ATTACHMENT CLIPS

IMPORTANT SAFETY INSTRUCTION - SAVE THESE INSTRUCTIONS

Read all of these installation instructions before installing the trac system.

Do not install this trac in damp or wet locations.

Do not install any fixture assembly closer than 6" from any curtain or similar combustible material.

Disconnect electrical power before adding to or changing the configuration of the trac.

Do not attempt to energize anything other than lighting fixtures on the trac. To reduce the risk of fire or electrical shock, do not attempt to connect power tools, extension cords, appliances and the like to the trac.

The TLR37 / TLR37916 is only to be used to support Juno TLV series and TLVR series trac.

Save these instructions and refer to them when additions to or changes in the trac configuration are made.

TLR37 / TLR37916 T-BAR ATTACHMENT CLIPS

Secures Juno TLV Series and TLVR Series trac to most standard 15/16" or 9/16" exposed tee ceiling suspension systems using either flush or drop ceiling tiles.

1. Determine where the trac will be installed, and mark grid ceiling according to the following:

* TLR Series Trac:

2' (TLVR 2FT) and 4' (TLVR 4FT) require (2) TLR37 or / (2) TLR37916 T-Bar clips.

6' (TLVR 6FT) and 8' (TLVR 8FT) require (3) TLR37 or / (3) TLR37916 T-Bar clips.

* TL Series Trac:

(1) TLR37 / TLR37916 T-Bar clip is required every 1 foot of trac.

2. Refer to the diagrams on page 2 to determine what components will be used for the application. Set aside the components that will not be used. (Note: all components supplied in this kit will not be used, they can be discarded after installation is complete)
3. Put the chosen screw through the hole in the T-Bar grid clip (verify screw rotation is prevented by the forms in the T-Bar grid clip). Snap the T-bar grid clip and screw assembly over the marks on the tee from step 1, and rotate until the grid clip locks into place (see below).

(continued on Page 2)

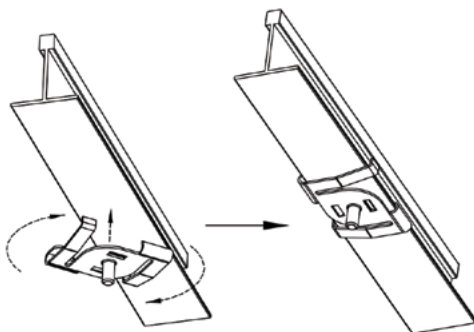

TLR37 / TLR37916 KIT CONTAINS:

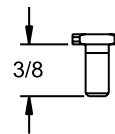

MOUNTING SCREW
#6-32 X 3/8" (YELLOW)

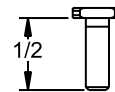

MOUNTING SCREW
#6-32 X 1/2" (SILVER)

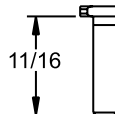

MOUNTING SCREW
#6-32 X 11/16" (BLACK)



#6-32 FLANGE NUT



#6-32 NYLON NUT

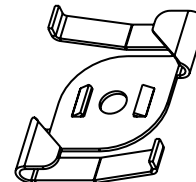

15/16" or 9/16"
T-BAR GRID CLIP

WARRANTY

Limited warranty located at:
www.acuitybrands.com/CustomerResources/Terms_and_conditions.aspx
Technical Services Phone (888) 387-2212

- 4. Regressed tile only:**
Thread #6-32 flange nut about halfway onto the installed T-Bar grid clip / screw assembly (shown in figures 1 & 3). Line up holes in trac with screws, and push trac into place. Adjust the height of the trac by tightening or loosening the #6-32 flange nut until the trac sits flush with the bottom of the ceiling tile.
- 5. Slide the trac over the installed T-bar grid clip/screw assemblies until it comes in contact with the clips (flush tile) or #6-32 flange nuts (drop tile). Hold trac in place, while fastening #6-32 nylon nuts until snug on all T-Bar grid clip assemblies.**

Figure 1 - TLVR Trac with a Drop Tile

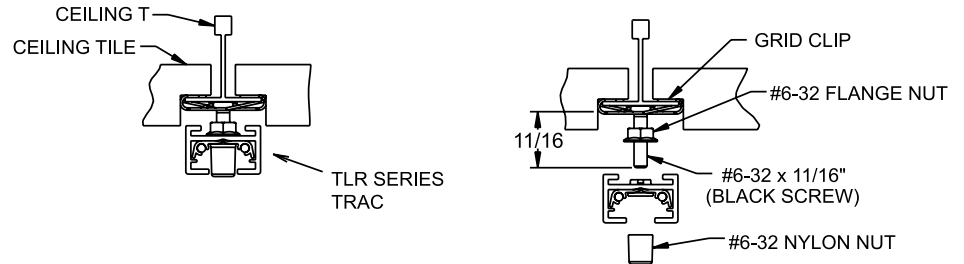

Figure 2 - TLVR Trac with a Flush Tile

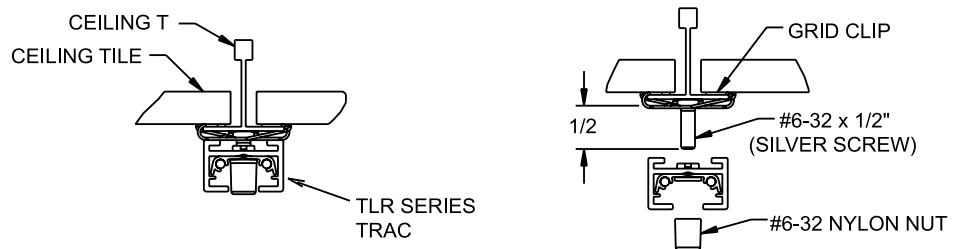

Figure 3 - TLV Trac with a Drop Tile

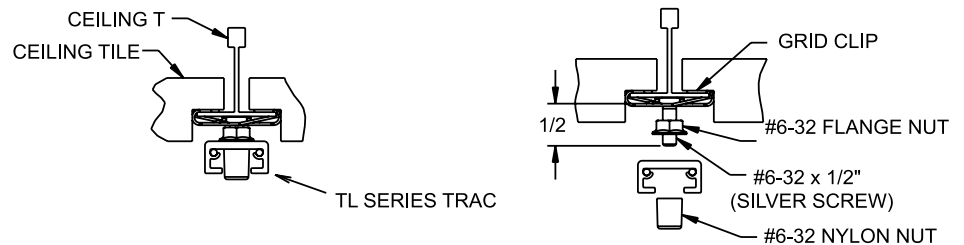

Figure 4 - TLV Trac with a Flush Tile

