



Die cast round covers with one or three 1/2" holes. Fit 4" round boxes. Supplied with thick foam rubber gasket and two #10-24 stainless steel screws. 3 hole cover comes with one die cast 1/2" close-up plug.

Color: Bronze

Weight: 0.2 lbs

Project:	Type:
Prepared By:	Date:

Technical Specifications

Compliance

UL Listed:

Suitable for wet locations

Construction

Covers:

Precision die cast aluminum round covers

Screws:

10-24 Brass Round Head Phillips/slotted

Gaskets:

1/8" thick closed cell silicone rubber for long lasting seal won't crumple or break

Hole Count:

3 Hole

Other

Replacement Plugs:

Available for round and rectangular covers and boxes

Buy American Act Compliance:

RAB values USA manufacturing! Upon request, RAB may be able to manufacture this product to be compliant with the Buy American Act (BAA). Please contact customer service to request a quote for the product to be made BAA compliant.

Dimensions

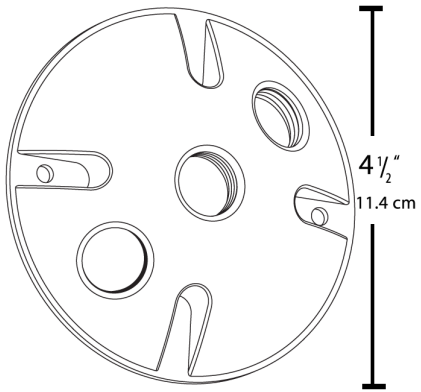

Features

- 1/8" thick weather seal gasket is closed cell silicone rubber for long lasting seal that won't break
- Stainless steel screws provided
- Die cast aluminum covers are color matched
- Close-up plugs allow Phillips or slotted screwdrivers for easy installation