

Product data sheet

Specifications

SQUARE D



Safety switch, heavy duty, fusible, 30A, 3 wire, 3 pole, 20HP, 600V AC/DC, NEMA 12

H361AWK

⚠ Discontinued on: Jun 23, 2023

⚠ Discontinued

Product availability: Stock - Normally stocked in distribution facility

Main

Product	Single Throw Safety Switch
Duty Rating	Heavy duty
Device Application	Heavy application
Disconnect Type	Fusible disconnect
Factory Installed Neutral	None
Number of Poles	3
Current Rating	30 A
Voltage Rating	600 V AC/DC
Enclosure Rating	NEMA 3R/12 galvanized steel
Motor power hp	5 hp at 480 V AC 50-60 Hz for 3 phase motors 15 hp at 480 V AC 50-60 Hz for 3 phase motors 7.5 hp at 600 V AC 50-60 Hz for 3 phase motors 20 hp at 600 V AC 50-60 Hz for 3 phase motors 5 hp at 250 V DC 15 hp at 600 V DC

Complementary

Short-circuit current	10 kA for H or K 200 kA for R or J
Fuse type	H or K R or J
Mounting Type	Surface
Electrical Connection	Lugs
Wiring configuration	3-wire (3P)
Wire Size	AWG 12...AWG 6 aluminium AWG 14...AWG 6 copper
Tightening torque	45 lbf.in (5.08 N.m) 0.02 in ² (13.3 mm ²) (AWG 6) 40 lbf.in (4.5 N.m) 0.013 in ² (8.367 mm ²) (AWG 8) 35 lbf.in (4.0 N.m) 0.003...0.008 in ² (2.06...5.261 mm ²) (AWG 14...AWG 10)
Depth	4.96 in (125.98 mm)
Width	7.55 in (191.77 mm)
Height	14.6 in (370.8 mm)
Product Weight	11.02 lb(US) (5 kg)

Environment

Price is "List Price" and may be subject to a trade discount – check with your local distributor or retailer for actual price.

Certifications	UL listed file E2875
-----------------------	----------------------

Ordering and shipping details

Category	US10DE100113
-----------------	--------------

Discount Schedule	0DE1
--------------------------	------

GTIN	785901481997
-------------	--------------

Returnability	Yes
----------------------	-----

Country of origin	US
--------------------------	----

Packing Units

Unit Type of Package 1	PCE
-------------------------------	-----

Number of Units in Package 1	1
-------------------------------------	---

Package 1 Height	5.50 in (13.97 cm)
-------------------------	--------------------

Package 1 Width	7.50 in (19.05 cm)
------------------------	--------------------

Package 1 Length	17.50 in (44.45 cm)
-------------------------	---------------------

Package 1 Weight	10.6 lb(US) (4.8 kg)
-------------------------	----------------------

Contractual warranty

Warranty	18 months
-----------------	-----------



Environmental Data

Schneider Electric aims to achieve Net Zero status by 2050 through supply chain partnerships, lower impact materials, and circularity via our ongoing “Use Better, Use Longer, Use Again” campaign to extend product lifetimes and recyclability.

[Environmental Data explained >](#)

[How we assess product sustainability >](#)

 Environmental footprint	
Carbon footprint (kg CO2 eq, Total Life cycle)	42
Environmental Disclosure	Product Environmental Profile

Use Better

 Materials and Substances	
Packaging made with recycled cardboard	Yes
Packaging without single use plastic	Yes
EU RoHS Directive	Compliant with Exemptions
California proposition 65	WARNING: This product can expose you to chemicals including: Lead and lead compounds, which is known to the State of California to cause cancer and birth defects or other reproductive harm. For more information go to www.P65Warnings.ca.gov
PVC free	Yes

Use Again

 Repack and remanufacture	
Circularity Profile	No need of specific recycling operations

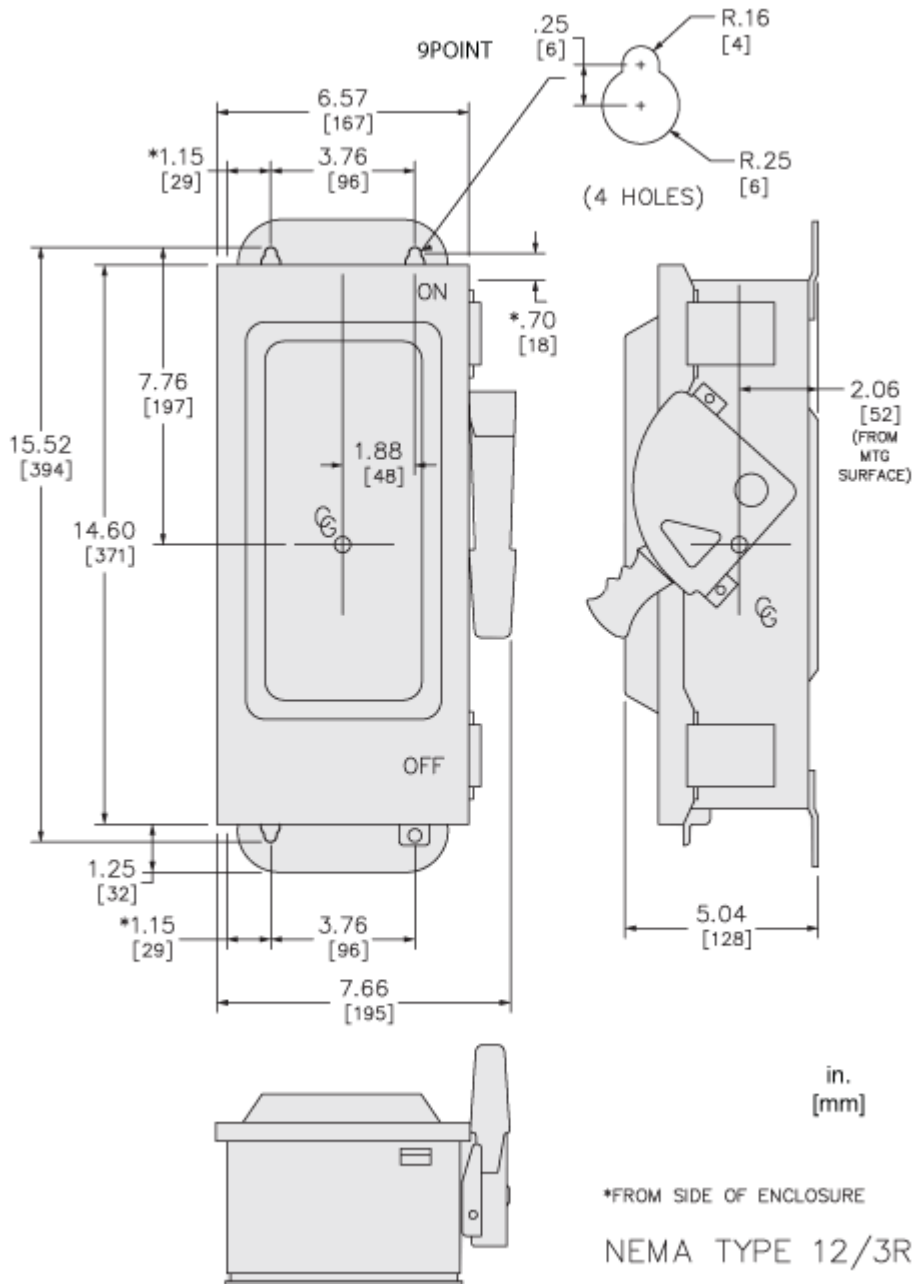

Dimensions Drawings

Approximate Dimensions



Connections and Schema

Connections and Wiring Diagrams

WIRING DIAGRAMS		
FUSIBLE		NOT FUSIBLE
 <p>H221AWK</p>	 <p>H321AWK H361AWK</p>	 <p>HU361AWK HU361AWKEI</p>