

Catalog Number
Notes
Type

FEATURES & SPECIFICATIONS

INTENDED USE — The Lithonia Lighting JEBL LED High bay is an affordable LED solution for users who prefer a luminaire with the look and feel of a round form factor. The JEBL delivers comfortable and uniform lighting from mounting heights up to 30ft. **Certain airborne contaminants can diminish the integrity of acrylic and/or polycarbonate.** [Click here for Acrylic and Polycarbonate Environmental Compatibility table for suitable uses.](#) **Certain airborne contaminants may adversely affect the functioning of LEDs and other electronic components, depending on various factors such as concentrations of the contaminants, ventilation, and temperature at the end-user location.** [Click here for a list of substances that may not be suitable for interaction with LEDs and other electronic components.](#)

CONSTRUCTION — JEBL features a white die-cast aluminum housing along with a removable die-cast aluminum driver housing. Powder coat corrosion resistant finish provides 500 hours salt fog rating. Corrosion resistant external hardware standard. Optional clear polycarbonate or diffuse aluminum reflectors available separately.

OPTICS — A .16" thick clear tempered glass lens protects LEDs. Placement, spacing, and aperture of LEDs provides a 120 degree spread of light. Optional frosted glass and polycarbonate solutions available.

ELECTRICAL — High-efficiency LEDs. 0-10V dimming standard for a dimming range of 100% to 10%. Input voltage is MVOLT (120-277V) and HVOLT (347-480V). Suitable for 50/60Hz.

Luminaire Surge Protection Level: Designed to withstand up to 6kV/3kA per ANSI C82.77-5-2015.

L90 > 54,000 hours.

CONTROLS — Dimming and non-dimming sensors, along with nLightAIR, may be factory installed utilizing the wiring box accessory that is attached to the top of the fixture.

INSTALLATION — 1/4" NPT eye bolt with 1/2" thick loop and 6' cord with dimming lead provided for easy installation. 3/4" reducer available for stem or hook mounting. Optional surface mount bracket allows flexibility by adjusting in 15 degree increments for a total range of 150 degrees. Also capable of accepting 3/4" stem or hook.

LISTINGS — UL/C-UL listed to US and Canadian Safety Standards. Wet location listed. For use under covered ceilings. For use in ambient temperatures from -40°F (-40°C) to 131°F (55°C see operational data). IP65 rated. Certified to meet NSF Splash Zone 2.

DesignLights Consortium® (DLC) Premium qualified product. Not all versions of this product may be DLC Premium qualified. Please check the DLC Qualified Products List at www.designlights.org/QPL to confirm which versions are qualified.

WARRANTY — 5-year limited warranty. Complete warranty terms located at: www.acuitybrands.com/support/warranty/terms-and-conditions

Note: Actual performance may differ as a result of end-user environment and application. All values are design or typical values, measured under laboratory conditions at 25 °C. Specifications subject to change without notice.

LED High Bay

JEBL



A+ Capable Luminaire

This item is an A+ capable luminaire, which has been designed and tested to provide consistent color appearance and out-of-the-box control compatibility with simple commissioning.

- All configurations of this luminaire meet the Acuity Brands' specification for chromatic consistency
- This luminaire is part of an A+ Certified solution for nLight® control networks marked by a [shaded background](#)*

To learn more about A+, visit www.acuitybrands.com/aplus.

*See ordering tree for details

LED High Bay



A+ Capable options indicated by this color background.



Looking for Contractor Select readily available configurations? Click here to visit Contractor Select™ spec sheet or go to www.contractorselect.com

ORDERING INFORMATION

Lead times will vary depending on options selected. Consult with your sales representative.

Example: JEBL 18000LM GL MVOLT 40K 80CRI DWHXD

Series	Lumens	Lens	Voltage	Color Temperature	Color Rendering Index	Mounting	
JEBL	12000LM 12,000 lumens	GL Glass lens	MVOLT (120-277V)	40K 4000 K	80CRI 80 CRI	(blank) standard eyebolt	
	18000LM 18,000 lumens	FRGL Frosted Glass lens	HVOLT (347-480V)	50K 5000 K		PM Pendant mount, 3/4 adapter installed	
	24000LM 24,000 lumens	PFL Frosted Polycarbonate lens	120 120V				
	30000LM 30,000 lumens		208 208V				
			240 240V				
			277 277V				
			347 347V				
			480 480V				

Options	Finish
<p>WGX wire guard installed</p> <p>SMB Surface mount bracket</p> <p>WBF Wiring box required for sensor and cord attachment, factory installed</p> <p>SCF120 Safety cable 120"</p> <p>SCF240 Safety cable 240"</p> <p>HKM Hook, male, damp location ‡</p> <p>HKF Hook, female, damp location ‡</p> <p>LPM Loop, male, damp location ‡</p> <p>LPF Loop, female, damp location ‡</p> <p>Cordsets:</p> <p>HC3PC3RWT Wet location, hook, 3' cord, plug and receptacle ‡</p> <p>OCS RELOC® OnePass® selectable cable 6' installed (dry location labeled) ‡</p> <p>OCU RELOC® OnePass® unselectable cable 6' installed (must specify tap position) (dry location labeled) ‡</p> <p>CS88 Brad Harrison 3P male straight 600V molded plug, 6' type ST00W yellow PVC cord, 16/3, must specify voltage, wet location ‡</p> <p>CS88L12 Brad Harrison 3P male straight 600V molded plug, 12' type ST00W yellow PVC cord, 16/3, must specify voltage, wet location ‡</p> <p>CS89L12 12' white cord, 16/3, no plug, wet location ‡</p> <p>CS6G16STOW5D 6' white cord, 16/5, no plug, includes low voltage dimming wires, wet location ‡</p> <p>C6PW 6' white cord with NEMA twist lock plug, wet location ‡</p> <p>C12PW 12' white cord with NEMA twist lock plug, wet location ‡</p> <p>L/DIM less dimming cord ‡</p>	<p>DWHXD Super durable, white</p> <p>DBLXD Super durable, black</p>
<p>Controls: ‡</p> <p>Non -Dimming Sensors:</p> <p>SBOR10 360° motion sensor integral, low bay 8-15 ft., on/off, IP66 rated. SBOR spec sheet</p> <p>SBOR10 P 360° motion sensor integral with photocell & occupancy sensor, low bay 8-15 ft., on/off, IP66 rated. SBOR spec sheet</p> <p>SBOR6 360° motion sensor integral, high bay 15-30 ft., on/off, IP66 rated. SBOR spec sheet</p> <p>SBOR6 P 360° motion sensor integral with photocell & occupancy sensor, high bay 15-30 ft., on/off, IP66 rated. SBOR spec sheet</p> <p>Dimming Sensors:</p> <p>SBOR10 D 3V 360° motion sensor integral, low bay 8-15 ft., on/off with second time-out period, goes to a dimmed state before turning off max./min. Dim setting, IP66 rated. SBOR spec sheet</p> <p>SBOR6 D 3V motion sensor integral, high bay 15-30 ft., on/off with second time-out period, goes to a dimmed state before turning off max./min. Dim setting, IP66 rated. SBOR spec sheet</p> <p>nLight wireless:</p> <p>NLTAIR2 RSBOR6 nLight AIR Generation 2 enabled 360° high mount motion sensor</p> <p>NLTAIR2 RSBOR10 nLight AIR Generation 2 enabled 360° low mount motion sensor</p>	

NOTE: ‡ indicates option chosen has ordering restrictions. Please reference ordering restrictions chart below. Options are sorted alphabetically.

Accessories: Order as separate catalog number.	
JEBLPCLR1 M4	Polycarbonate clear reflector for 12L and 18L
JEBLDALR1 M4	Diffuse Aluminum reflector for 12L and 18L
JEBLPCLR2 M4	Polycarbonate clear reflector for 24L and 30L
JEBLDALR2 M4	Diffuse Aluminum reflector for 24L and 30L
JEBLMTG ADAPTER M12	3/4" reducer
JEBLSMB1 M6	Surface mount bracket for 12L and 18L
JEBLSMB2 M6	Surface mount bracket for 24L and 30L
JCBLSC120	Safety cable 120"
JCBLSC240	Safety cable 240"
JEBLWG1 M6	Wire guard for use with 12000LM or 18000LM fixtures
JEBLWG2 M6	Wire guard for use with 24000LM or 30000LM fixtures

‡ Option Value Ordering Restrictions	
Option value	Restriction
C12PW	Not available with MVOLT or HVOLT. Requires WBF option. If black cord is required remove "W". EX: C12P
C6PW	Not available with MVOLT or HVOLT. If black cord is required remove "W". EX: C6P Black cord ships standard when DBLXD is ordered.
Controls	Require WBF option.
CS6G16STOW5D	Not available with SBOR10 D 3V, SBOR6 D 3V, SBOR10 P, SBOR6 P, or any NLTAIR@ sensor. Requires WBF option.
CS88	Requires WBF option.
CS88L12	Requires WBF option.
CS89L12	Requires WBF option.
HC3PC3RWT	PM option required. Not available with MVOLT or HVOLT. Requires WBF option.
HKF	PM option required
HKM	PM option required
L/DIM	Select this option when original dimming cord is not required. If this option is selected there will be no access to dimming leads.
LPF	PM option required
LPM	PM option required
OCS	Not available with MVOLT or HVOLT. Requires WBF option. Available also in 10', 15', and 20'. EX: OCS15
OCU	Not available with MVOLT or HVOLT. Requires WBF option.

LED High Bay

ACCESSORIES



JEBLDALR

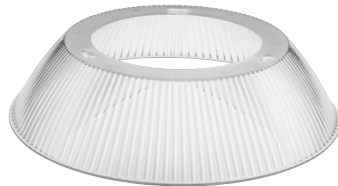

JEBLPCLR



JEBL with DALR



Hook with 3/4" adapter

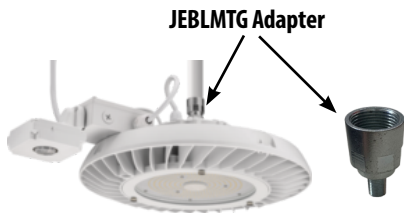

JEBLMTG Adapter

OPERATIONAL DATA

Lumen package	Voltage	Reflector	CCT	CRI	Nominal lumens			Wattage
					Lens type			
					GL	FRGL	PFL	
12000LM	MVOLT	No reflector	40K	80CRI	13630	11703	11581	95
			50K		13790	11840	11717	
		DALR	40K		12565	11047	10770	
			50K		12713	11176	10896	
		PCLR	40K		13025	11239	11205	
			50K		13178	11371	11336	
	HVOLT	No reflector	40K		13285	11407	11289	92
			50K		13381	11489	11370	
		DALR	40K		12248	10767	10497	
			50K		12337	10845	10573	
		PCLR	40K		12696	10955	10922	
			50K		12787	11034	11000	
18000LM	MVOLT	No reflector	40K	80CRI	19303	16574	16402	135
			50K		19529	16765	16594	
		DALR	40K		17796	15644	15252	
			50K		18005	15828	15431	
		PCLR	40K		18446	15917	15869	
			50K		18662	16104	16055	
	HVOLT	No reflector	40K		19679	16897	16722	136
			50K		19821	17018	16842	
		DALR	40K		18143	15949	15549	
			50K		18274	16064	15661	
		PCLR	40K		18806	16227	16178	
			50K		18941	16344	16295	
24000LM	MVOLT	No reflector	40K	80CRI	24181	20762	20547	174
			50K		24464	21006	20788	
		DALR	40K		22294	19598	19107	
			50K		22555	19828	19331	
		PCLR	40K		23108	19940	19879	
			50K		23379	20174	20112	
	HVOLT	No reflector	40K		26558	22803	22566	181
			50K		26749	22967	22729	
		DALR	40K		24485	21524	20985	
			50K		24661	21679	21136	
		PCLR	40K		25379	21900	21833	
			50K		25561	22057	21990	
30000LM	MVOLT	No reflector	40K	80CRI	30263	25984	25715	215
			50K		30618	26289	26016	
		DALR	40K		27901	24527	23912	
			50K		28228	24815	24193	
		PCLR	40K		28920	24955	24879	
			50K		29259	25248	25171	
	HVOLT	No reflector	40K		31421	26979	26699	218
			50K		31647	27173	26891	
		DALR	40K		28969	25466	24828	
			50K		29178	25649	25006	
		PCLR	40K		30027	25910	25832	
			50K		30243	26097	26017	

LED High Bay

DIMENSIONS

All dimensions are in inches unless otherwise indicated.

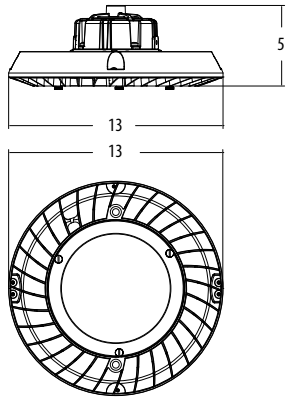

JEBL 12L/18L

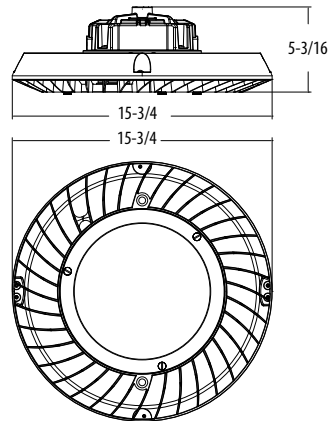
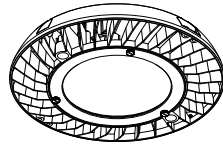

JEBL 24L/30L

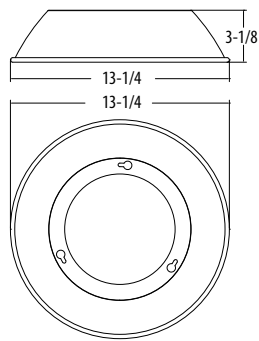
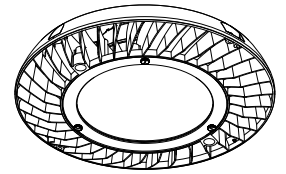

JEBLDARL1

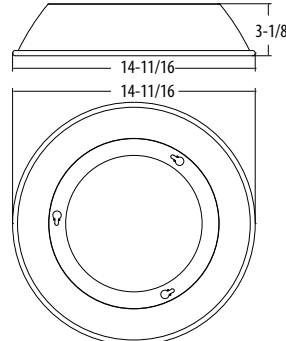
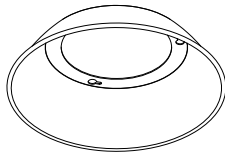

JEBLDARL2

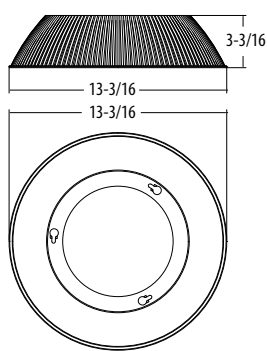
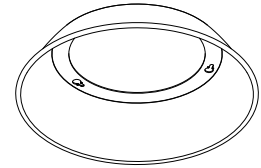

JEBLPCLR1

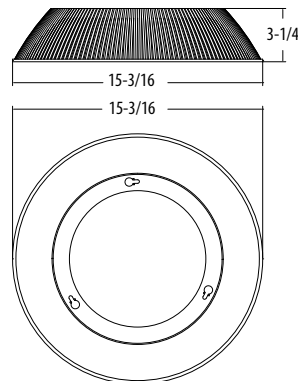
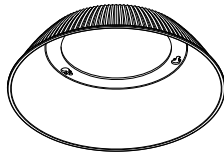

JEBLPCLR2

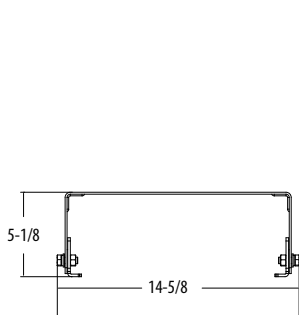
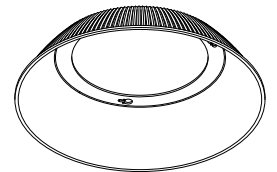

JEBLSMB1

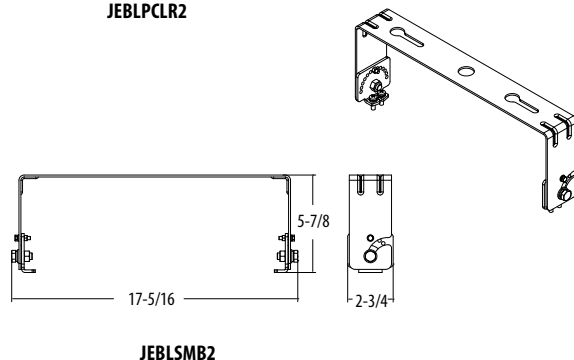
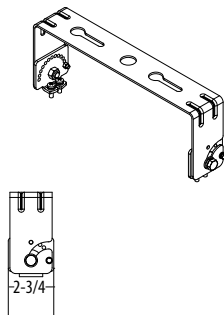

JEBLSMB2