

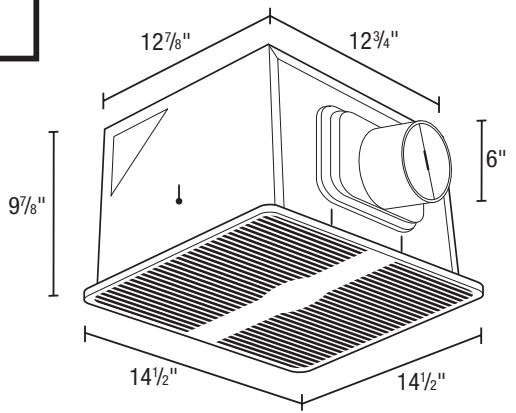

SPECIFICATIONS
AK200LS
 EXHAUST FANS

2100 HVI CERTIFIED **200 CFM/1.2 Sones @ 0.10" SP.**
183 CFM @ 0.25 SP.



- **Grill**
White, polymeric grill secured in place with torsion springs; easily removed if necessary, dimensions - 14 1/2" x 14 1/2".
- **Blower Wheel**
Balanced polymeric dual inlet blower wheel 6" dia. x 5 3/8" depth, 59 paddles, secured in place using 8M hex nut.
- **Motor**
Enclosed 4 pole high efficiency, permanently split capacitor motor (PSC); life time lubrication, suitable for continuous operation. Motor bearings - ball. Rated 115/120 volts, 60 Hz.
- **Fan Housing**
23 gauge galvanized steel housing.
Overall dimensions: 12 7/8" x 12 3/4" x 9 7/8".
- **Duct Collar**
6" round, zinc plated metal collar adapter. Gasketed, spring loaded aluminum backdraft damper.
- **Ventilating Area**
For bathrooms up to 200 sq. ft. For other rooms up to 250 sq. ft.
- **Electrical Connections**
1/2" electrical knockouts provided. Easy wiring access via either internal or external wiring compartment cover.
- **Single Pack Shipping Info**
Box Dim: 20" x 16" x 11 1/4"
UPC: 0-8316222002-8
Shipping Weight: 14.6 lbs.

Acceptable for use over tub or shower when installed in a GFCI protected branch circuit.



- **Unit Mounting**
The housing will mount through drywall thickness up to 3/4", with a rough-in opening of 12 7/8" x 13". The housing will mount either between 16" or 24" on center joists, using the 2 supplied housing mounting brackets. The housing mounting brackets can be adapted for overhead mounting (hardware not provided). The unit is provided with an optionally installed ceiling flange to ensure proper building infiltration rates are maintained and that no air leaks occur between the fan housing and ceiling cutout.

EXPANDED PERFORMANCE											
	Static Pressure (inches of w.g.)							Sones @ .1 SP	Fan Speed RPM	Maximum Fan Watts	Amps
	0	0.1	0.2	0.25	0.375	0.4	0.5				
Air Flow - CFM	207	200	191	185	162	156	122	1.2	932	57.0	0.7

PROJECT					ARCHITECT				
LOCATION					ENGINEER				
CONTRACTOR					SUBMITTED BY			DATE	
FAN NUMBER	MODEL NUMBER	CFM	IN W.G.	RPM	WATTS	AMPS	SONES	QTY	OPTIONAL EQUIPMENT & REMARKS



U.S.: 820 Lincoln Avenue
 West Chester, Pennsylvania 19380-4466
 Tel: (610) 692-7400 • 877-304-3785
 Fax: (610) 696-8048

Canada:
 Bolton, Ontario
 Tel: 905-456-2033