



HALO[®]

HL6 Series

ALLSLOPE LED Recessed Lighting



Innovation you can rely on™

HALO LED Slope Ceiling Solutions



Featuring unique interchangeable beam-forming optics, full range dimming and multiple color temperatures and trim options, the Halo ALLSLOPE LED Downlight System is specifically designed for slope ceiling applications with pitch aiming from 2/12 (10 degrees) to 12/12 (45 degrees). The innovative design allows the LED light engine full adjustment capability so it can be aimed straight down in accordance with the ceiling pitch, resulting in outstanding performance and appearance. The three piece system consists of a choice of a 6-inch aperture housing, available in 1200 lumens or 1800 lumens, an LED light engine with three interchangeable optics and a trim selection from a full line of compatible trims including reflectors, baffles and lens choices. The high-efficiency, energy-saving solution provides up to 73 percent in energy savings with virtually no maintenance for residential, hospitality, retail and institutional needs.

Rafter

Roof Pitch = Rise/Run

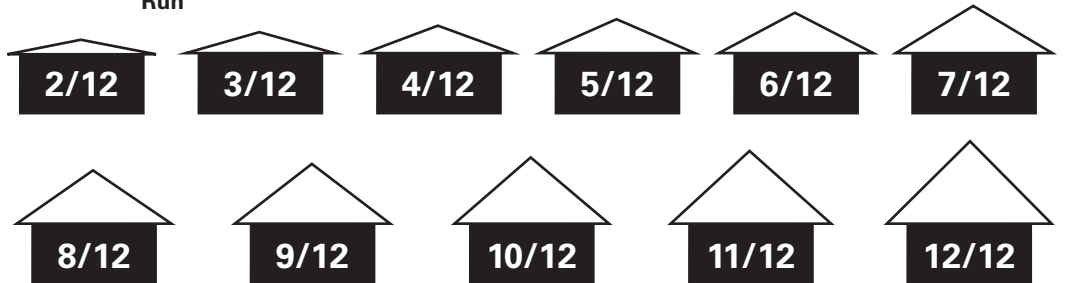
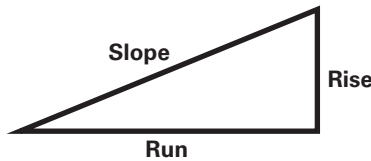

Slope Pitch "Rise Over Run"

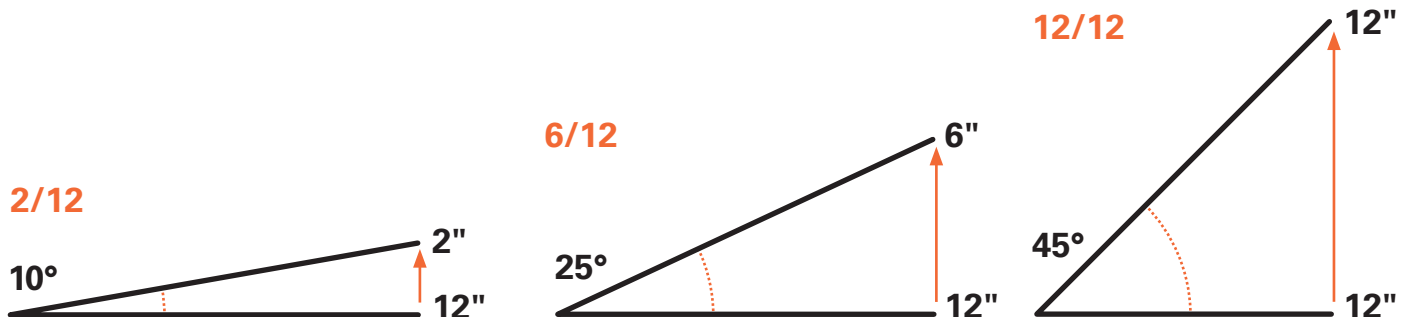

HALO HL6 ALLSLOPE 6" LED Slope Ceiling Downlight



A LED Housing

- HL6 ALLSLOPE LED features an internal aiming mechanism to align the LED light engine straight down regardless of ceiling pitch. The HL6 is a true ALLSLOPE fixture with ability to adjust for any slope ceiling from 2/12 to 12/12 pitch.
- The socket aiming mechanism adjusts to tilt the lamp straight down based upon ceiling pitch. A rotational collar allows trim alignment of up to 20 degree side-to-side rotation in ceiling corners with compound angles.
- LED driver is integrated in the housings for optimized lumen delivery.
- Two AIR-TITE™ housings are offered in 1200 Series Insulated Ceiling and 1800 Series Non-Insulated Ceiling

B LED Light Engine



- 90 Color Rendering Index (CRI)
- Correlated Color Temperature (CCT) options: 2700K, 3000K, 3500K, 4000K
- LED is a chip on board design consisting of a multiple LED package with proximity phosphor coating to create one virtual white light source for a productive cone of light
- Exclusively designed for the HL6 slope housings, the form-factor and performance replicate expected PAR lamp qualities in a high lumen LED light engine
- Specially designed heat sink conducts heat away from the LED to maintain LED junction temperatures
- Designed for interchangeable lens optics
 - 25° Narrow Flood (order separately)
 - 40° Flood (included with light engine)
 - 55° Wide Flood (order separately)



C LED Trim



- A wide selection of slope ceiling trims include reflectors, baffles, and lens styles
- The slope ceiling trims feature full contours that provide shielding and conform to ceiling slopes
- Trim options include Halo signature Coilex® baffle in white and black; reflectors in specular clear, semi-specular (haze), satin nickel and tuscan bronze; as well as lenses in flat, drop glass, and drop plastic styles for wet location listing in showers and protected ceilings (porches and soffits).

D AIR-TITE™ Construction

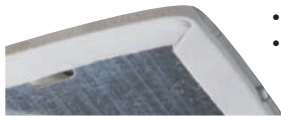

- Certified per ASTM E283 (not exceeding 2.0 CFM under 57 Pascals pressure difference)
- 1200 Series Insulated ceiling and 1800 Series Non-Insulated ceiling models

ALLSLOPE Housings

HL612ICAT – 1200 Series Insulated Ceiling Housing



Refer to ENERGY STAR® Certified Products List. Can be used to comply with California Title 24 High Efficacy requirements. Certified to California Title 20 Appliance Efficiency Database.

HL618TAT – 1800 Series Non-Insulated Ceiling Housing



Refer to ENERGY STAR® Certified Products List. Can be used to comply with California Title 24 Non-Residential Lighting Controls requirements as a LED Luminaire.

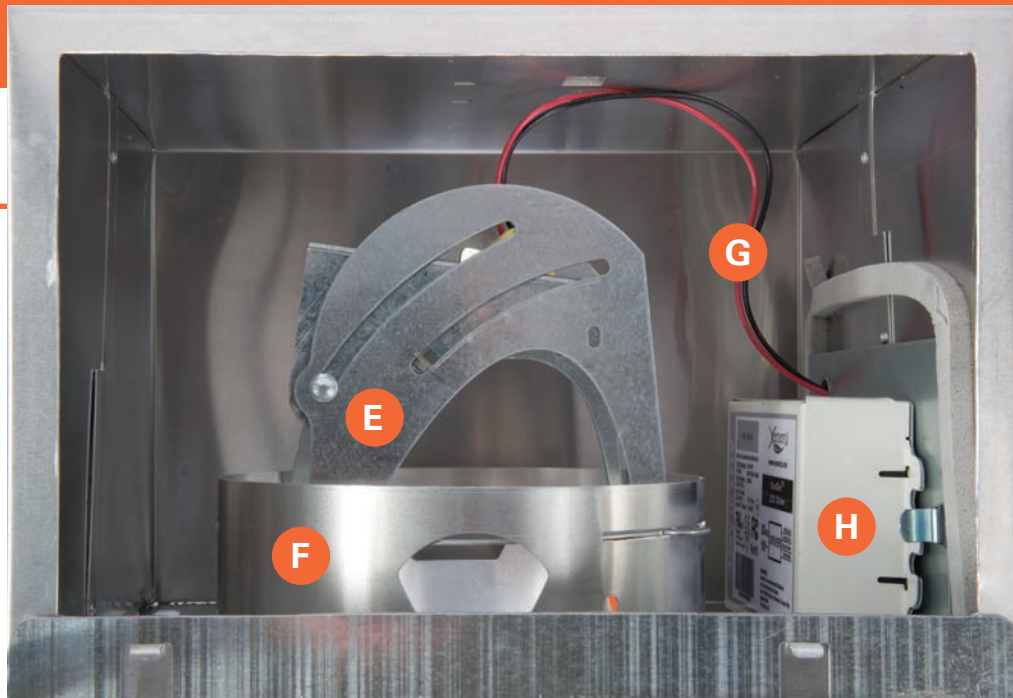

E Aiming Mechanism



- Exclusive socket aiming mechanism tilts to properly align the LED light engine
- LED light engine may be tilted and locked from 2/12 to 12/12 pitch (10° to 45° slope angle)
- Keyed opening in the socket plate matches tabs and blade springs of the turn-to-lock base on the LED light engine
- Two wing nuts for tool-less locking to desired pitch
- Pitch increments are stamped on side of mechanism for ease in pre-setting pitch

F Rotational Collar



- Rotational collar allows lateral adjustment up to 20°
- Brass knurl nut for tool-less adjustment
- Rotation provides alignment of the LED light engine and trim to compound slope ceilings requiring off-axis aiming
- Degree increments are stamped inside of collar to pre-set rotation angle

G LED Quick Connect



- LED connector is a plug-in quick-connect that offers tool-less installation of the LED light engine
- Provides low voltage connection from the LED driver in the housing to the LED light engine

H LED Dimmable Driver



- 120V-277V 50/60 Hz universal voltage, constant current dimmable driver
- Meets FCC 47CFR Part 15 EMI/RFI consumer limits for residential and commercial use
- Driver features high power factor, low THD and integral thermal protection
- Can also be operated from a standard wall switch
- Serviceable through the housing with internal accessibility
- Dual dimming capability offers wide use in residential and commercial spaces*
 - 120V Phase Control dimmers to nominal 5%
 - 0-10V dimmers to nominal 10% with compatible 0-10V DC (2-wire) low voltage dimmers

*Consult dimmer manufacturer for compatibility and conditions of use.

Light Engines

- LED light engines are designed exclusively for the HL6 ALLSLOPE housing system and feature the form-factor and performance that replicate PAR lamp qualities in a high lumen LED light engine
- LED package has proximity phosphors over high-density chip on board LEDs to provide a uniform source with high efficiency and no pixilation
- A tight chromaticity specification ensures LED color uniformity, sustainable Color Rendering Index (CRI) and Correlated Color Temperature (CCT) over the useful life of the LED
- Every Halo LED engine is quality tested, measured, and serialized in a permanent record to register lumens, wattage, CRI and CCT
- Halo LED serialized testing and measurement ensures color and lumen consistency over time
- A turn-to-lock base provides secure retention of the LED light engine to the housing's aiming mechanism, and provides a low-voltage electrical quick-connector
- Interchangeable lens optics feature beam distributions with refined visual shielding to control beam angle and lumen delivery in accommodating various slope ceiling heights



Light Engine Performance

- Open reflector and baffle trims
 - 1350 – 1750 lumens with HL612ICAT (1200 series) insulated ceiling housing
 - 1770-2280 lumens with HL618TAT (1800 series) non-insulated ceiling housing
- Lens trims
 - 740-1260 lumens with HL612ICAT insulated ceiling housing
 - 970-1650 lumens with HL618TAT non-insulated ceiling housing
- Correlated Color Temperature options include 2700K, 3000K, 3500K, and 4000K
- High color performance is delivered at 90 CRI minimum and R9 greater than 50
- LED color uniformity of 3 SDCM exceeds ENERGY STAR® color standards per ANSI C78.377- 2008
- Lumen maintenance L70 at 50,000 hours in accordance with IES LM-80 and TM-21
- Designed for use with interchangeable lens optics:
 - 25° Narrow Flood (order separately)
 - 40° Flood (included with light engine and available separately)
 - 55° Wide Flood (order separately)

Light Engine Lens Optic	CRI	CCT
HLM6927	90CRI	2700K
HLM6930	90CRI	3000K
HLM6935	90CRI	3500K
HLM6940	90CRI	4000K

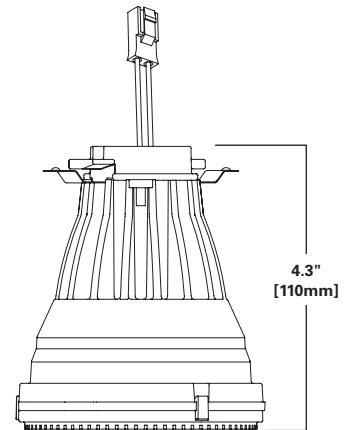
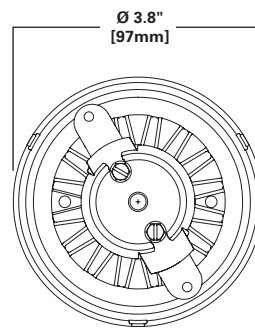
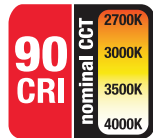

LED Energy Savings – HL612ICAT (1200 Series Housing)

HL6 ALLSLOPE replaces traditional light sources used for slope ceiling downlighting, and provides significant energy savings



HL6 LED 1200 Series

- 19 Watt
- HL6 LED IC housing (HL612ICAT)
- 3000K (HLM6930)
- Haze Trim (455H)
- 50,000 hrs. L70
- 1556 lumens
- \$6.45 / yr. Energy cost*

Replaces
Saves up to 73%

PAR38 IR Lamp

- 70 Watt
- PAR38/IRC – Infrared Halogen
- 2900K
- 4,200 hrs. life
- 1550 lumens
- \$23.76 / yr. Energy cost*



Lens Optics

HL6 LED system incorporates interchangeable lens optics in three beam distributions that offer refined visual shielding to control beam angle and lumen delivery accommodating various ceiling heights. Beam-forming lens optic choices offer customers the ability to adjust the cone of light beam angle in proportion to ceiling height while maintaining the punch needed for higher ceiling heights typical in slope ceiling construction.

- Lens optics provide beam distributions that have been precision designed in relation to the LED LES (light emitting surface). The HL6 lens optics achieve refined beam angles that surpass expectation of traditional reflector lamp sources
- Interchangeable lens:
 - 25° Narrow Flood (order separately)
 - 40° Flood (included with light engine and available separately)
 - 55° Wide Flood (order separately)
- The lens holder ring is designed exclusively for attachment to the HLM6 LED light engine with three snap-on tabs for ease in changing lenses



Lens Optic Selection



25° (NFL)

40° (FL)

55° (WFL)

The HL6 LED lens optic selection allows refinement in the lighting design so that average lumens can be delivered regardless of fixture height. For example a 12/12 pitch (45°) slope ceiling may have fixture mounting heights reaching up to 24-ft. at the peak where a 25° NFL lens would be used. And to follow through with the design, at mid-point of 19-ft. the 40° FL lens and low-point 14-ft. the 55° WFL lens would be used.

Lens Optic Model No.	Type
HL6NFL	25° Narrow Flood (NFL)
HL6FL	40° Flood (FL)
HL6WFL	55° Wide Flood (WFL)
HL6LHRPK	HL6 Lens holder ring, replacement part

LED Energy Savings – HL618TAT (1800 Series Housing)



HL6 LED 1800 Series

- 27 Watt
- HL6 LED NON-IC housing (HL618TAT)
- 3000K (HLM6930)
- Haze Trim (455H)
- 50,000 hrs. L70
- 2032 lumens
- \$9.16 / yr. Energy cost*

Replaces
Saves up to 73%

PAR38 IR Lamp

- 100 Watt
- PAR38/IRC – Infrared Halogen
- 2800K
- 4,200 hrs. life
- 2200 lumens
- \$33.95 / yr. Energy cost*



*Note on energy saving and yearly energy costs

- Lamp replacement comparisons and images are for general illustration of lumen equivalents, and not specific application. Field requirements may vary and require analysis and specification by the appropriate authority. Information contained in this comparison is from published information made available by the manufacturer or retailer and is deemed reliable but has not been verified.
- Per year energy cost is calculated as 6 hours operation per day at 365 days (2,190 hrs./yr.); with average electric cost of \$0.1550 /kWh based upon the average of MA, NJ, NY, IL and CA residential data, other areas may be more or less.
- LED lumens are delivered values, used here as representative for each respective product series. Lumen values may vary based upon the options selected for CCT (Correlated Color Temperature) and trim finish.

6" Reflector Trims



455SC
Specular Clear Reflector, White Metal Trim Ring, Coil Spring Retention



455H
Semi-Specular Haze Reflector, White Metal Trim Ring, Coil Spring Retention

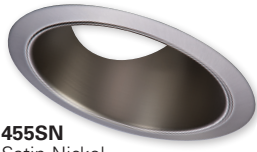

455SN
Satin Nickel Reflector, Satin Nickel Metal Trim Ring, Coil Spring Retention



455TBZ
Tuscan Bronze Reflector, Tuscan Bronze Metal Trim Ring, Coil Spring Retention

Dimensions



Reflector Options

Clear
Haze
Satin Nickel
Tuscan Bronze

Accessories Available

OT400P = Oversize flat white metal trim ring 6" I.D. x 9-1/4" O.D. (oversize ring slips behind the trim ring, in stepped configuration)
OT403P = Oversize white plastic trim ring 6" I.D. x 8" O.D. (oversize ring slips behind the trim ring, in stepped configuration)
TRM690WH = Oversize matte white metal trim ring. Designed for trim ring to inset into oversize ring for an even (non-stepped) trim surface



TRM690WH
Oversize trim ring accessory

6" Coilex® Baffle Trims



456W
White Coilex Baffle, White Metal Trim Ring, Coil Spring Retention



456P
Black Coilex Baffle, White Metal Trim Ring, Coil Spring Retention

Dimensions

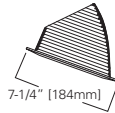

Baffle Options

One piece seamless Coilex® Baffle:
White
Black

Accessories Available

TRM6P = White Metal
TRM6C = Chrome Metal
TRM6SN = Satin Nickel Metal
TRM6TBZ = Tuscan Bronze Metal
TRM6MB = Black Metal
TRM7MB = Black Polymer



6" Lens and Diffuser Trims



70P
Albalite Glass
Lens, White Polymer Trim Ring



70PS
Albalite Glass
Lens, White Polymer Trim Ring,
Wet Location "Dead Front"
- Showerlight



70SNS
Albalite Glass
Lens, Satin Nickel Polymer
Trim Ring, Wet Location "Dead
Front" - Showerlight

Dimensions



Description

- White and Satin Nickel trims with Frosted Albalite Glass Lens
- 70PS and 70SNS are wet location listed and for use in showers
- 70PS and 70SNS have "Dead Front" Non-conductive, non-corrosive gasketed polymer trim ring
- Torsion spring retention



71P
Drop Opal
Glass Lens, White
Polymer Trim Ring



71PS
Drop Opal Glass Lens,
White Polymer Trim Ring,
Wet Location "Dead Front"
- Showerlight



ERT702
Drop Opal Plastic Lens, Gloss White
Polymer Trim Ring, Wet Location "Dead Front" - Showerlight

Description

- White trim with glass Drop Opal Lens
- 71PS is wet location listed
- 71PS has "Dead Front"
- Non-conductive, non-corrosive gasketed polymer trim ring
- Torsion spring retention

Dimensions

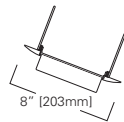

Dimensions

Description

- White trim with plastic Drop Opal Lens
- Wet location listed for use in showers
- "Dead Front" Non-conductive, non-corrosive gasketed polymer trim ring
- Torsion spring retention

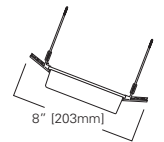

73P
Fresnel Glass
Lens, White Polymer Trim Ring



73PS
Fresnel Glass
Lens, White Polymer Trim Ring,
Wet Location "Dead Front"
- Showerlight

Description

- White trim with glass Fresnel Lens
- 73PS is wet location listed for use in showers
- 73PS has "Dead Front"
- Non-conductive, non-corrosive gasketed polymer trim ring
- Torsion spring retention

Dimensions

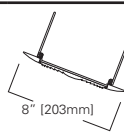

Trim Attachments

Reflectors and Baffles – Coil Springs

Coil spring hook attaches to vertical slots in the sides of aiming mechanism. Slip-fit on spring allows positioning of finger hold loop inside the trim for ease of installation.

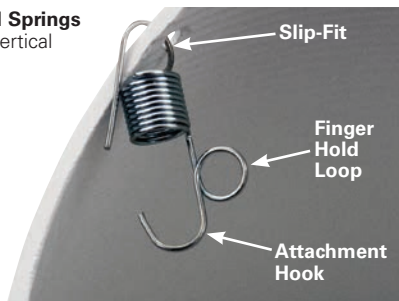

Lens and Diffusers – Torsion Springs

Torsion springs insert into horizontal slots in top of the rotational collar

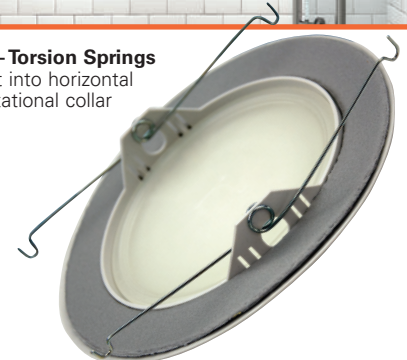

HALO

Housing – Features

- Three slope ceiling housings to choose:
 - Insulated ceilings (HL612ICAT)
 - Non-insulated ceilings (HL618TAT)
 - Non-insulated Chicago Plenum ceilings (HL618TCP)
- ICAT and TAT designated housings are AIR-TITE™ certified per ASTM E283
- Include standard Halo features:
 - Got Nail!™ Bar hangers with pre-installed nail and integral T-grid clip
 - Slide-N-Side™ wire traps and quick-connects for tool-less wiring outside the junction box
 - Pass-N-Thru™ bar hanger feature for tool-less shortening of bars without removal from frame

For proper slope aiming install with junction box in upward position.

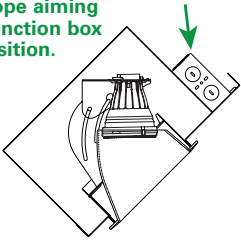

LED Driver – Features

- LED Driver is accessible inside the housing
- 120V-277V 50/60 Hz universal voltage, constant current dimmable driver
- Meets FCC 47CFR Part 15 EMI/RFI consumer limits for residential and commercial use
- High power factor, low THD, and integral thermal protection
- Can be operated from a standard wall switch if dimming is not required
- Dual dimming capability offers wide use in residential and commercial spaces*
 - 120V Phase Control dimmers to nominal 5% with many Leading Edge (LE) and Trailing Edge (TE) dimmers
 - 0-10V dimmers to nominal 10% with compatible 0-10V DC low voltage dimmers (operate using two low voltage dimming wires color coded violet and gray)

Improper Install

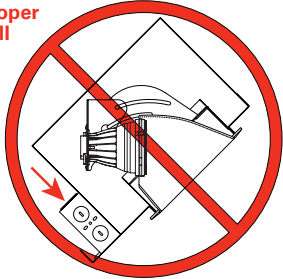

*Consult dimmer manufacturer for compatibility and conditions of use. Note some dimmers require a neutral in the wallbox.

HALO HL612ICAT – Specifications

Insulated Ceiling, New Construction Housing

- cULus 1598 Type IC, suitable for direct contact with insulation*
 - Listed for damp locations.
 - Wet location listed with designated lens trims
- AIR-TITE™
 - Certified per ASTM E283; not exceeding 2.0 CFM under 75 Pascals pressure difference
- Energy Code compliant
 - ENERGY STAR® certified luminaire - consult ENERGY STAR® Certified Product List
 - Can be used for California Title 24 residential or non-residential compliance - Title 20 certified
 - Can be used for International Energy Conservation Code (IECC) compliance
 - Can be used for Washington State Energy Code compliance
- EMI/RFI per FCC 47CFR Part 15 Class B Consumer limits (residential and commercial compliant)
- Contains no mercury or lead and RoHS compliant
- Junction box features a separate compartment for 0-10V DC low voltage dimming connections, to comply with NEC.

*Not to be used in direct contact with spray foam insulation

Energy Data

HL612ICAT (1200 Series)

Min. operating temperature	-30C/-22F	
Input Voltage	120V	277V
Input Current (A)	0.16	0.07
Input Power (W)	19.1	20.0
Input Frequency	50/60Hz	
FCC 47CFR Part 15 EMI/RFI	Consumer Limits (Residential & Commercial)	
THD	≤ 20%	
Power Factor	≥ 0.9	
Sound Rating	Class A	



HL612ICAT

HL612ICAT – 1200 Series

Insulated Ceiling Housing



Refer to ENERGY STAR® Certified Products List. Can be used to comply with California Title 24 High Efficacy requirements. Certified to California Title 20 Appliance Efficiency Database.

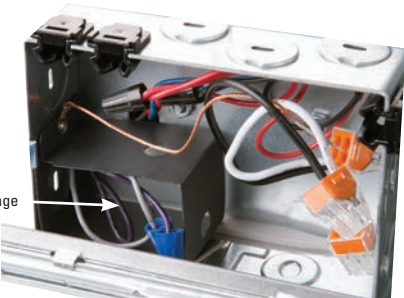

Junction Box
0-10V DC low voltage
dimming wiring
compartment

Housing – Dimensions

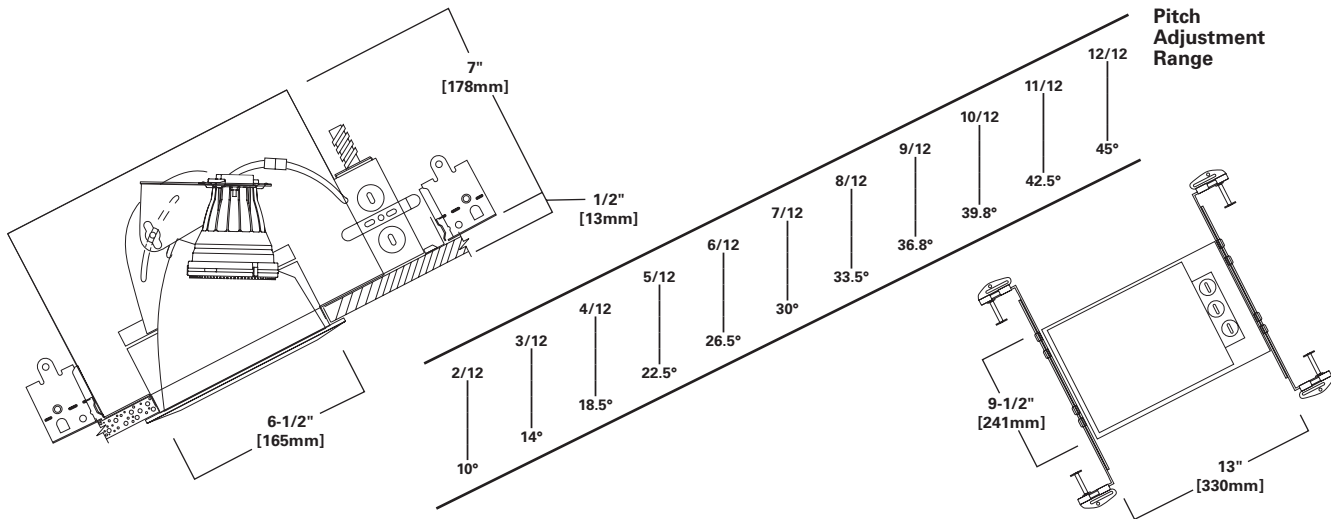

HALO HL618TAT & HL618TCP – Specifications

Non-Insulated Ceiling, New Construction Housing

- cULus 1598 Type Non-IC, if insulation is present it must be kept 3" from sides and top of housing
 - Listed for damp locations.
 - Wet location listed with designated lens trims
- AIR-TITE™
 - Certified per ASTM E283; not exceeding 2.0 CFM under 75 Pascals pressure difference
- Energy Code compliant
 - ENERGY STAR® certified luminaire - consult ENERGY STAR® Certified Product List
 - Can be used to comply with California Title 24 Non-Residential Lighting Controls requirements as a LED Luminaire
- EMI/RFI per FCC 47CFR Part 15 Class B Consumer limits (residential and commercial compliant)
- Contains no mercury or lead and RoHS compliant.
- Chicago Plenum model (HL618TCP) is specially constructed and marked for Chicago Plenum applications (CCEA)
- Junction box features a separate compartment for 0-10V DC low voltage dimming connections, to comply with NEC.

Energy Data

HL618TAT & HL618TCP (1800 Series)

Min. operating temperature	-30C/-22F	
Input Voltage	120V	277V
Input Current (A)	0.23	0.10
Input Power (W)	27.6	27.0
Input Frequency	50/60Hz	
FCC 47CFR Part 15 EMI/RFI	Consumer Limits (Residential & Commercial)	
THD	≤ 20%	
Power Factor	≥ 0.9	
Sound Rating	Class A	



HL618TAT

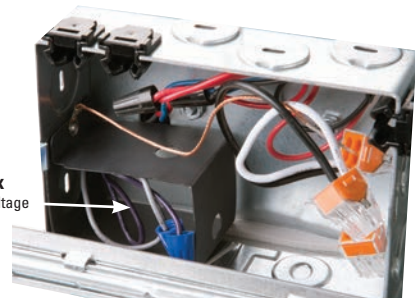

Junction Box
0-10V DC low voltage
dimming wiring
compartment

HL618TAT – 1800 Series Non-Insulated Ceiling Housing



Refer to ENERGY STAR® Certified Products List. Can be used to comply with California Title 24 Non-Residential Lighting Controls requirements as a LED Luminaire.

Application Modeling – Simulation #1 (12/12 Pitch – 1800 Series)

Simulation #1

Steep 12/12 pitch slope ceiling
 Room Data
 12/12 Pitch (45° angle)
 5' x 6' Spacing
 20' X 24' Room

Luminaire Data

HL618TAT (1800 Series)
 2700K HLM6927
 Haze trim 455H

12/12 Pitch	Value
Avg. fc	23.91
Max. fc	40.10
Min. fc	3.60
Avg/Min	6.64
Max/Min	11.14

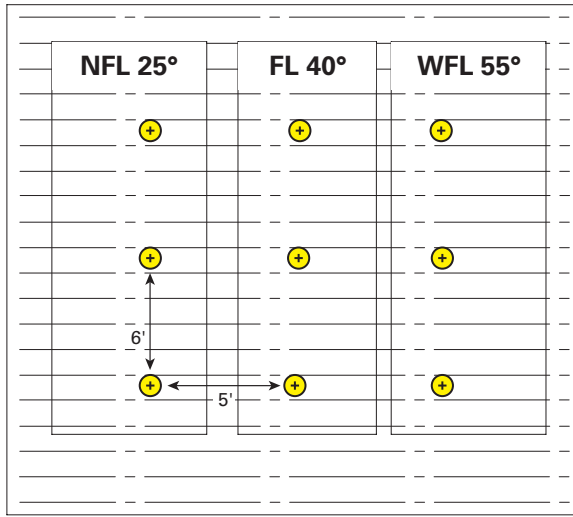

Floor Plan View

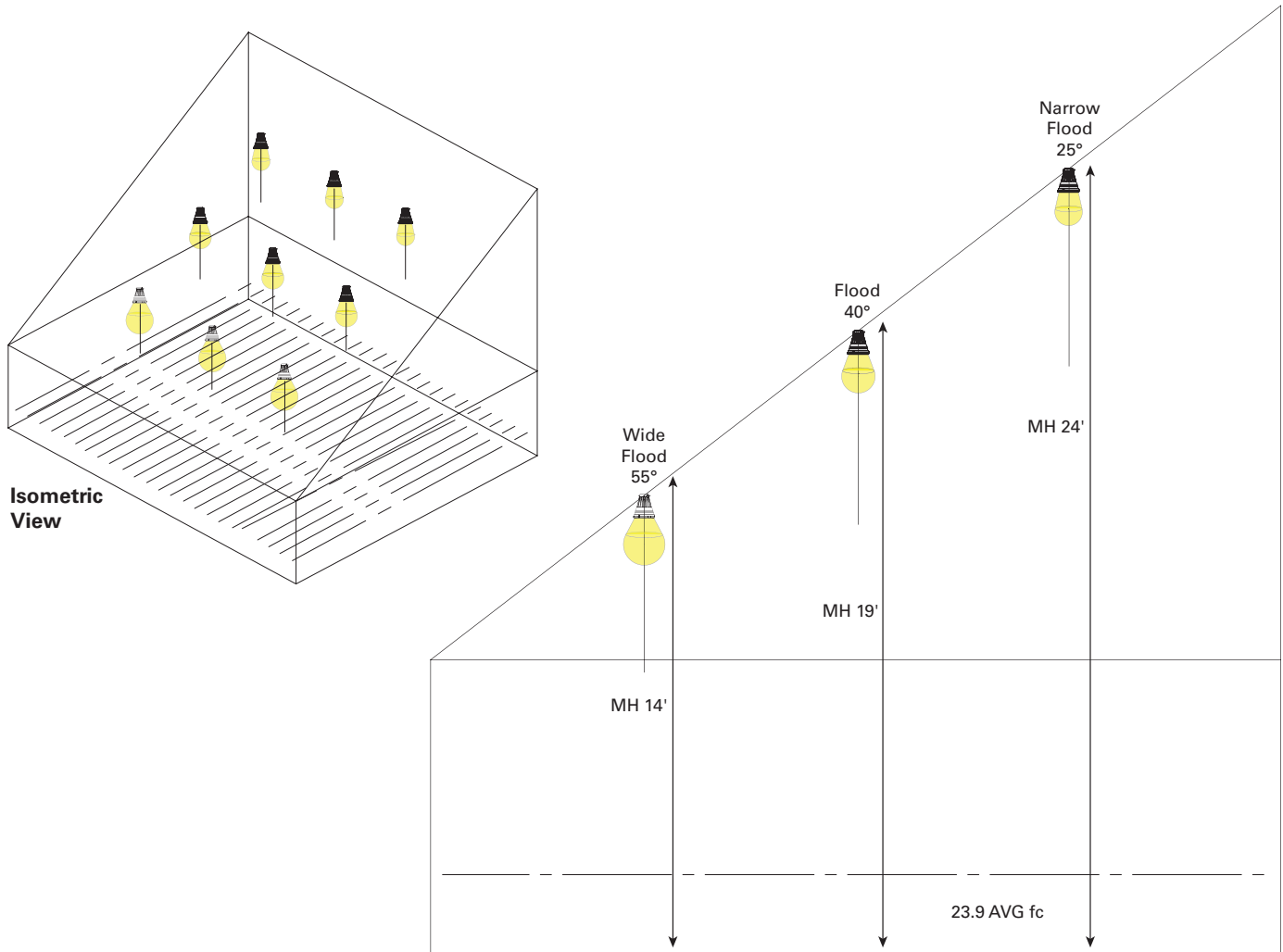

Side View 12/12 Pitch

Application Modeling – Simulation #2 (2/12 Pitch – 1200 Series)



Simulation #2
 Steep 2/12 pitch slope ceiling
 Room Data
 2/12 Pitch (10° angle)
 5' x 6' Spacing
 20' X 24' Room

Luminaire Data
HL612ICAT (1200 Series)
 2700K HLM6927
 Haze trim 455H

2/12 Pitch	Value
Avg. fc	24.10
Max. fc	48.30
Min. fc	1.50
Avg/Min	19.07
Max/Min	32.20

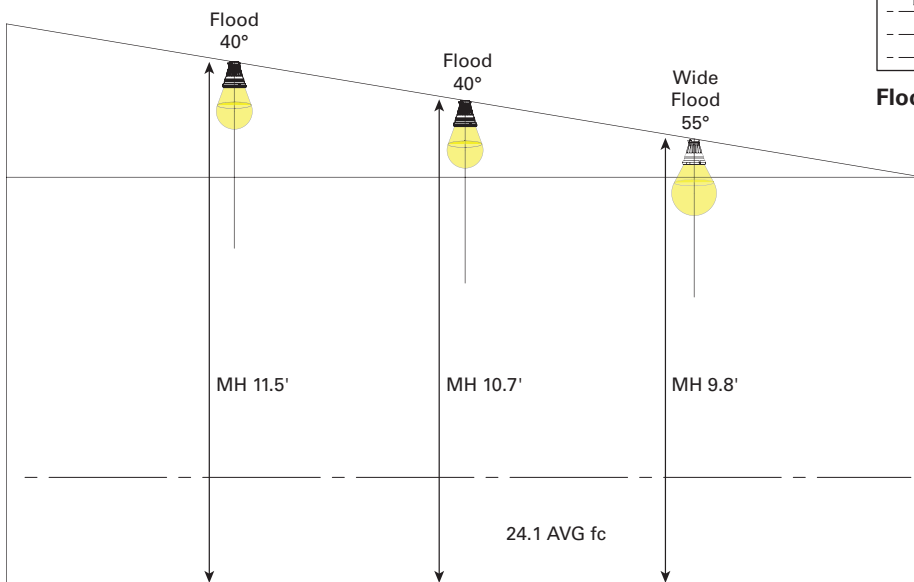
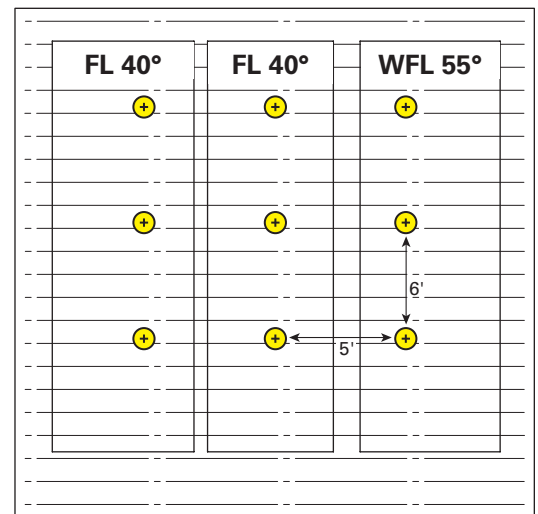
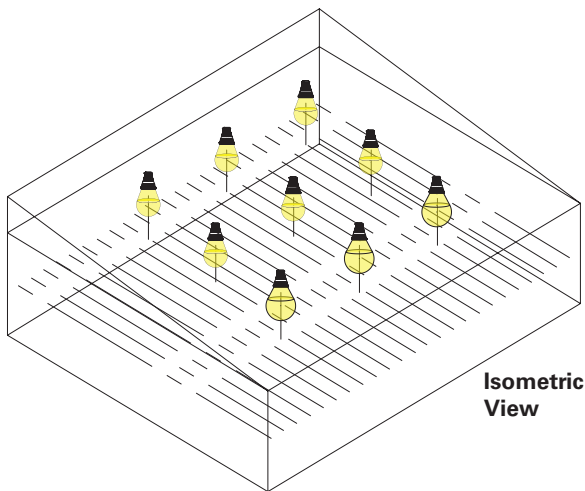



Lumen & Energy Code Compliance Summary – HL612ICAT (1200 Series)

Trims	HL612ICAT - HLM6927			HL612ICAT - HLM6930			HL612ICAT - HLM6935			HL612ICAT - HLM6940		
	Lumens	LpW	Compliance	Lumens	LpW	Compliance	Lumens	LpW	Compliance	Lumens	LpW	Compliance
70PS	743	38		804	42	ES, IECC, WSEC	853	44	ES, IECC, WSEC	883	46	ES, IECC, WSEC
71PS	764	40		826	43	ES, IECC, WSEC	877	45	ES, IECC, WSEC	907	47	ES, IECC, WSEC
ERT702	1010	52	ES, IECC, WSEC	1093	57	ES, IECC, WSEC	1159	60	ES, T24, IECC, WSEC	1200	62	ES, T24, IECC, WSEC
73PS	1068	55	ES, IECC, WSEC	1155	60	ES, T24, IECC, WSEC	1225	64	ES, T24, IECC, WSEC	1268	66	ES, T24, IECC, WSEC
456P	1355	70	ES, T24, IECC, WSEC	1465	76	ES, T24, IECC, WSEC	1555	81	ES, T24, IECC, WSEC	1609	84	ES, T24, IECC, WSEC
455TBZ	1366	71	ES, T24, IECC, WSEC	1477	77	ES, T24, IECC, WSEC	1567	82	ES, T24, IECC, WSEC	1622	84	ES, T24, IECC, WSEC
455SN	1399	73	ES, T24, IECC, WSEC	1513	79	ES, T24, IECC, WSEC	1606	84	ES, T24, IECC, WSEC	1662	87	ES, T24, IECC, WSEC
455H	1443	75	ES, T24, IECC, WSEC	1527	79	ES, T24, IECC, WSEC	1616	84	ES, T24, IECC, WSEC	1672	87	ES, T24, IECC, WSEC
456W	1461	76	ES, T24, IECC, WSEC	1580	82	ES, T24, IECC, WSEC	1676	87	ES, T24, IECC, WSEC	1735	90	ES, T24, IECC, WSEC
455SC	1475	77	ES, T24, IECC, WSEC	1595	83	ES, T24, IECC, WSEC	1692	88	ES, T24, IECC, WSEC	1751	92	ES, T24, IECC, WSEC

Wattage 19.1

LpW = Lumens per Watt

Tested in accordance with IES LM-79 Photometric Measurement Standards. Field results may vary.

Lumen & Energy Code Compliance Summary – HL618TAT & HL618TCP (1800 Series)

Trims	HL618TAT - HLM6927			HL618TAT - HLM6930			HL618TAT - HLM6935			HL618TAT - HLM6940		
	Lumens	LpW	Compliance	Lumens	LpW	Compliance	Lumens	LpW	Compliance	Lumens	LpW	Compliance
70PS	971	35	T24NR	993	35	T24NR	1114	40	T24NR	1153	41	T24NR
71PS	998	36	T24NR	1080	39	T24NR	1145	41	T24NR	1185	42	T24NR
ERT702	1320	47	ES, T24NR	1413	51	ES, T24NR	1514	54	ES, T24NR	1567	56	ES, T24NR
73PS	1395	50	ES, T24NR	1415	51	ES, T24NR	1600	57	ES, T24NR	1656	60	ES, T24NR
456P	1770	64	ES, T24NR	1821	65	ES, T24NR	2030	73	ES, T24NR	2101	76	ES, T24NR
455TBZ	1784	64	ES, T24NR	1882	68	ES, T24NR	2047	74	ES, T24NR	2118	76	ES, T24NR
455SN	1828	66	ES, T24NR	1938	70	ES, T24NR	2097	75	ES, T24NR	2170	78	ES, T24NR
455H	1936	70	ES, T24NR	2045	74	ES, T24NR	2177	78	ES, T24NR	2247	81	ES, T24NR
456W	1908	69	ES, T24NR	1978	71	ES, T24NR	2189	79	ES, T24NR	2265	82	ES, T24NR
455SC	1926	69	ES, T24NR	2069	74	ES, T24NR	2209	80	ES, T24NR	2286	82	ES, T24NR

Wattage 27.6

LpW = Lumens per Watt

Tested in accordance with IES LM-79 Photometric Measurement Standards. Field results may vary.

Energy Codes

ES: Refer to the ENERGY STAR® Certified Products List

T24: Can be used to comply with California Title 24 High Efficacy requirements. Certified to California Title 20 Appliance Efficiency Database.

T24NR: Can be used to comply with California Title 24 Non-Residential Lighting Controls requirements as a LED Luminaire.

IECC: Can be used to comply with International Energy Conservation Code Residential Energy Efficiency, High Efficacy Luminaire

WSEC - Washington State Energy Code Residential Energy Efficiency, High Efficacy Luminaire

Notes: Energy code compliance is noted as of publication. Energy codes, product compliance and product specifications are subject to change without notice. For the latest information on codes and applicable product compliance consult the code authority.

Ordering Information

Order LED housing, LED engine with lens optic, and trim separately for a complete luminaire.



HL612ICAT

Housing Description

HL612ICAT 6" Slope ceiling, insulated ceiling rated, AIR-TIGHT™, recessed housing, UNV 120V/277V

Product details on page 8

HL618TAT & HL618TCP

Housing Description

HL618TAT 6" Slope ceiling, non-insulated ceiling rated, AIR-TIGHT™, recessed housing, UNV 120V-277V

HL618TCP 6" Slope ceiling recessed housing, non-insulated ceiling rated, CCEA marked for chicago plenum, UNV 120V-277V

Product details on page 9

Light Engine

Light Engine	CRI	CCT
HLM6927	90CRI	2700K
HLM6930	90CRI	3000K
HLM6935	90CRI	3500K
HLM6940	90CRI	4000K

Product details on page 4

Lens Optic Description

Lens Optic	Description
HL6NFL	25° Narrow flood lens (NFL)
HL6FL	40° Flood lens (FL) – included with light engine
HL6WFL	55° Wide flood lens (WFL)
HL6LHRPK	HL6 Lens holder ring, replacement part

Product details on page 5

Trims Description

Trims	Description
455SC	Specular clear reflector, white metal trim ring
455H	Semi-specular haze reflector, white metal trim ring
455SN	Satin nickel reflector, satin nickel metal trim ring
455TBZ	Tuscan bronze reflector, tuscan bronze metal trim ring
456W	White coilex baffle, white metal trim ring
456P	Black coilex baffle, white metal trim ring
70P	Albalite glass lens, white polymer trim ring
70PS	Albalite glass lens, white polymer trim ring, wet location - showerlight
70SNS	Albalite glass lens, satin nickel polymer trim ring, wet location - showerlight
71P	Drop opal glass lens, white polymer trim ring
71PS	Drop opal glass lens, white polymer trim ring, wet location - showerlight
73P	Fresnel glass lens, white polymer trim ring
73PS	Fresnel glass lens, white polymer trim ring, wet location - showerlight
ERT702	Drop opal plastic lens, gloss white polymer trim ring, wet location - showerlight

Product details on page 6 & 7

Accessories Description

Accessories	Description
OT400P	Over size white metal trim ring, for use with 6" trims (to be used behind standard trim ring) 6.0" I.D., 9.25" O.D.
OT403P	Over size gloss white polymer trim ring, replaces standard ring included with 455 and 456 trims 6.0" I.D., 8.0" O.D.
TRM690WH	6" LED over size trim ring, white 6.9" I.D., 9.5" O.D. Ring slips over LED trim. Inset design allows 6" trim to fit into over size ring surface
TRM6C	Chrome metal designer trim ring (for 455 and 456 trims)
TRM6MB	Black metal designer trim ring (for 455 and 456 trims)
TRM6P	White metal designer trim ring (for 455 and 456 trims)
TRM6SN	Satin nickel designer trim ring (for 455 and 456 trims)
TRM6TBZ	Tuscan bronze designer trim ring (for 455 and 456 trims)
TRM7MB	Black polymer designer trim ring (for 455 and 456 trims)

Product details on page 6

Lighting Control Solutions

AL All Load Dimmers

Cooper Lighting Solutions' AL Series dimmers offer versatile options to set the mood and reduce energy consumption. These compatible LED dimmers are ideal for both residential and light commercial applications and are compatible with decorator (screwless) style devices and wallplates. Refer to www.cooperlighting.com for additional information.



ACCELL (AAL06)



DEVINE (DAL06P)



SKYE (SAL06P)



TRACE (TAL06P)

6/12 Pitch • 1200 Series • 90 CRI

Multiplier Table

CCT Option	2700 K	3000 K	3500 K	4000 K
CCT Multiplier	0.925	1.000	1.061	1.120

Table based upon testing with 3000°K color temperature, 90CRI.

Multipliers may be used to determine relative lumen values with other color temperatures.

HL612ICAT - HLM6930 - HL6NFL - 455H

Test Number	P130198
Light Module	1200 Series, 90CRI
Lens Optic	25° Narrow Flood
Trim	6" Aperture, Haze Trim
Lumens	1535 Lm
Efficacy	80.4 Lm/W
CCT	3000K
SC (0/90/45)	1.94 / 0.73 / 1.15

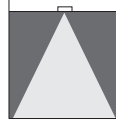

Legend

0-deg:	---
90-deg:	---
180-deg:	---

Candlepower Distribution

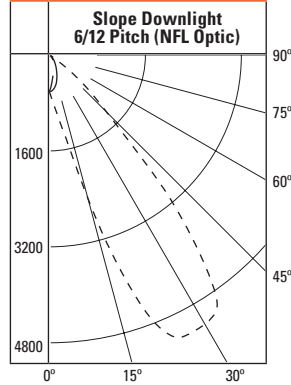

Cone of Light

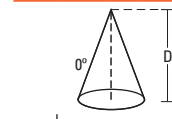

D	FC	L	W
5.5'	129.9	2.8	2.6
7'	80.2	3.6	3.2
8'	61.4	4.1	3.8
9'	48.5	4.6	4.2
10'	39.3	5.2	4.6
12'	27.3	6.2	5.6

Zonal Lumen Summary

Zone	Lumens	%Fixture
0-30	761	49.6
0-40	1241	80.8
0-60	1521	99.1
0-90	1535	100
90-180	0	0
0-180	1535	100

HL612ICAT - HLM6930 - HL6FL - 455H

Test Number	P130162
Light Module	1200 Series, 90CRI
Lens Optic	40° Flood
Trim	6" Aperture, Haze Trim
Lumens	1556 Lm
Efficacy	81.5 Lm/W
CCT	3000K
SC (0/90/45)	1.6 / 0.65 / 1.06

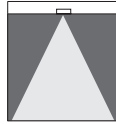

Legend

0-deg:	---
90-deg:	---
180-deg:	---

Candlepower Distribution

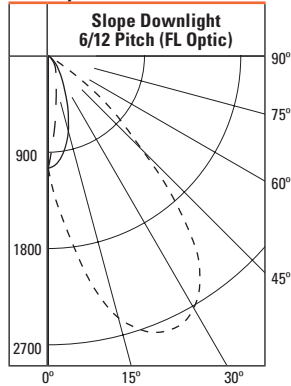

Cone of Light

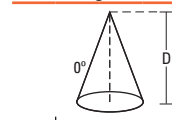

D	FC	L	W
5.5'	76.1	4	3.6
7'	47	5.1	4.6
8'	36	5.8	5.4
9'	28.4	6.6	6
10'	23	7.4	6.6
12'	16	8.8	8

Zonal Lumen Summary

Zone	Lumens	%Fixture
0-30	814	52.3
0-40	1219	78.3
0-60	1537	98.8
0-90	1556	100
90-180	0	0
0-180	1556	100

HL612ICAT - HLM6930 - HL6WFL - 455H

Test Number	P130235
Light Module	1200 Series, 90CRI
Lens Optic	55° Wide Flood
Trim	6" Aperture, Haze Trim
Lumens	1535 Lm
Efficacy	80.4 Lm/W
CCT	3000K
SC (0/90/45)	1.45 / 0.76 / 1.17

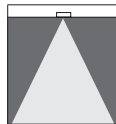

Legend

0-deg:	---
90-deg:	---
180-deg:	---

Candlepower Distribution

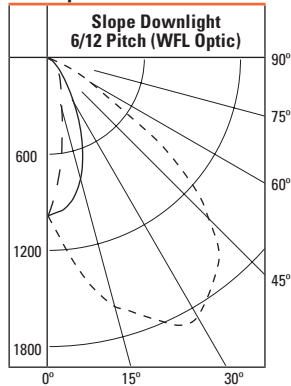

Cone of Light

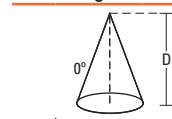

D	FC	L	W
5.5'	47.8	5.1	5
7'	29.5	6.5	6.4
8'	22.6	7.5	7.2
9'	17.9	8.4	8.2
10'	14.5	9.4	9
12'	10	11.3	11

Zonal Lumen Summary

Zone	Lumens	%Fixture
0-30	689	44.9
0-40	1070	69.7
0-60	1502	97.8
0-90	1535	100
90-180	0	0
0-180	1535	100

Photometric tests are per IES measurement standards. Tests represent typical fixture performance. Field results may vary.

6/12 Pitch • 1800 Series • 90 CRI

Multiplier Table

CCT Option	2700 K	3000 K	3500 K	4000 K
CCT Multiplier	0.925	1.000	1.061	1.120

Table based upon testing with 3000°K color temperature, 90CRI.

Multipliers may be used to determine relative lumen values with other color temperatures.

HL618TAT - HLM6930 - HL6NFL - 455H

Test Number	P130064
Light Module	1800 Series, 90CRI
Lens Optic	25° Narrow Flood
Trim	6" Aperture, Haze Trim
Lumens	2106 Lm
Efficacy	76.3 Lm/W
CCT	3000K
SC (0/90/45)	1.94 / 0.73 / 1.15

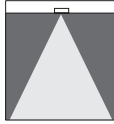

Legend

0-deg:	---
90-deg:	---
180-deg:	---

Candlepower Distribution

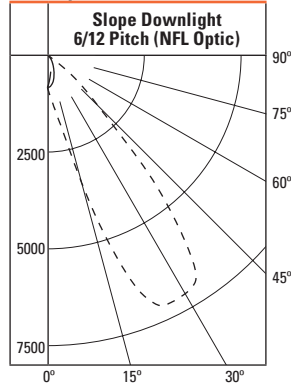

Cone of Light

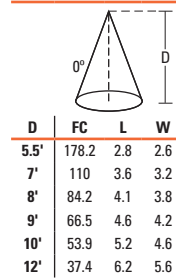

Zonal Lumen Summary

Zone	Lumens	%Fixture
0-30	1044	49.6
0-40	1702	80.8
0-60	2086	99.1
0-90	2106	100
90-180	0	0
0-180	2106	100

HL618TAT - HLM6930 - HL6FL - 455H

Test Number	P130027
Light Module	1800 Series, 90CRI
Lens Optic	40° Flood
Trim	6" Aperture, Haze Trim
Lumens	2032 Lm
Efficacy	73.6 Lm/W
CCT	3000K
SC (0/90/45)	1.6 / 0.65 / 1.06



Legend

0-deg:	---
90-deg:	---
180-deg:	---

Candlepower Distribution

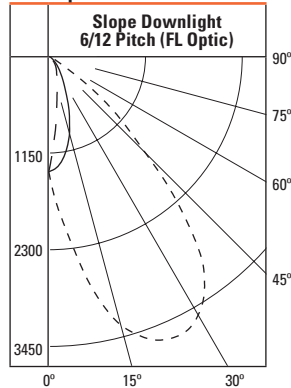

Cone of Light

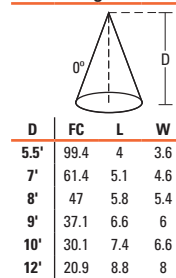

Zonal Lumen Summary

Zone	Lumens	%Fixture
0-30	1062	52.3
0-40	1592	78.3
0-60	2007	98.8
0-90	2032	100
90-180	0	0
0-180	2032	100

HL618TAT - HLM6930 - HL6WFL - 455H

Test Number	P130104
Light Module	1800 Series, 90CRI
Lens Optic	55° Wide Flood
Trim	6" Aperture, Haze Trim
Lumens	2137 Lm
Efficacy	77.4 Lm/W
CCT	3000K
SC (0/90/45)	1.45 / 0.76 / 1.17



Legend

0-deg:	---
90-deg:	---
180-deg:	---

Candlepower Distribution

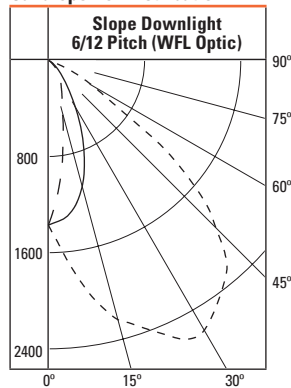

Cone of Light

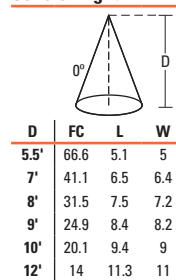

Zonal Lumen Summary

Zone	Lumens	%Fixture
0-30	959	44.9
0-40	1490	69.7
0-60	2091	97.9
0-90	2137	100
90-180	0	0
0-180	2137	100

Photometric tests are per IES measurement standards. Tests represent typical fixture performance. Field results may vary.



Lighting Product Lines

Ametrix
AtLite
Corelite
Ephesus
Fail-Safe
HALO
HALO Commercial
Invue
io
IRiS
Lumark
Lumière
McGraw-Edison
Metalux
MWS
Neo-Ray
Portfolio
RSA
Shaper
Streetworks
Sure-Lites

Controls Product Lines

Greengate

Connected Lighting Systems

Fifth Light (Canada Only)
HALO Home
WaveLinX

IoT Platform

Trellix



Cooper Lighting Solutions
1121 Highway 74 South
Peachtree City, GA 30269
P: 770-486-4800
cooperlighting.com

Canada Sales
5925 McLaughlin Road
Mississauga, Ontario L5R 1B8
P: 905-501-3000
F: 905-501-3172



© 2021 Cooper Lighting Solutions
All Rights Reserved
Publication No. BR518001EN
May 2021

Product availability, specifications,
and compliances are subject to
change without notice.