

INSTALLATION INSTRUCTIONS

EZPAN® 1X4, 2X2, 2X4

RAB®

RAB Lighting is committed to creating high-quality, affordable, well-designed and energy-efficient LED lighting and controls that make it easy for electricians to install and end users to save energy. We'd love to hear your comments. Please call the Marketing Department at 888-RAB-1000 or email: marketing@rablighting.com

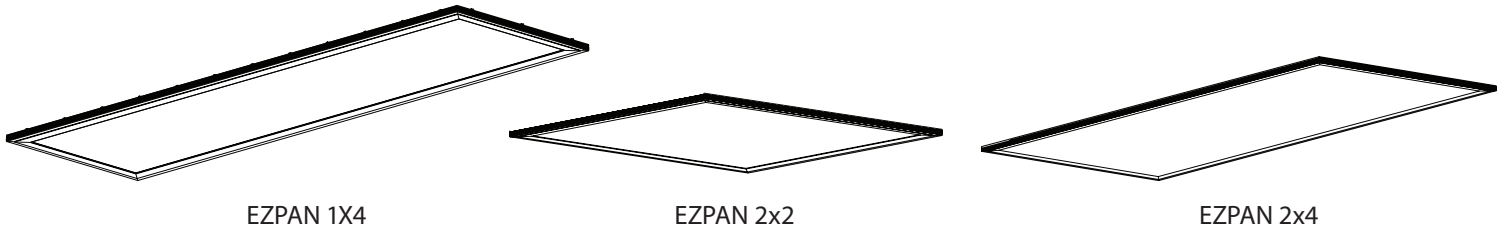

IMPORTANT

READ CAREFULLY BEFORE INSTALLING FIXTURE. RETAIN THESE INSTRUCTIONS FOR FUTURE REFERENCE.

RAB fixtures must be wired in accordance with the National Electrical Code and all applicable local codes. Proper grounding is required for safety. THIS PRODUCT MUST BE INSTALLED IN ACCORDANCE WITH THE APPLICABLE INSTALLATION CODE BY A PERSON FAMILIAR WITH THE CONSTRUCTION AND OPERATION OF THE PRODUCT AND THE HAZARDS INVOLVED.

WARNING: Make certain power is OFF before installing or maintaining fixture. No user serviceable parts inside.

SAFETY INSTRUCTIONS

WARNING: Risk of fire or electric shock. Suitable for Damp locations.

WARNING: Suitable for 9/16" or 15/16" Flat Tee Grid in both Insulated Ceilings and Non-Insulated Ceilings. Access above ceiling required.

WARNING: Do not handle energized fixture when hands are wet, when standing on wet or damp surfaces, or in water.

WARNING: Vapor barrier must be suitable for 90° C.

WARNING: Fixture to be independently supported to building structure.

RECESSED CEILING MOUNTING

The fixture is suitable only for INDOOR RECESSED CEILING application. Above ceiling access required.

To mount in an insulated or non-insulated ceiling - 9/16" or 15/16" exposed Flat Tee Grid Ceiling follow the steps below.

1. Firmly bend the pre-installed **Grid Clips** (*up and out as shown in Fig. 1*).
2. Rotate and slide the **Fixture** as required to fit through the **Tee-Grid Bar** and place it as indicated by the directional arrow as shown in Fig. 2. Secure the **Fixture** to the **Tee-Grid Bar**.
3. Support wires are required by Installation Codes. Support the **Fixture** to the building structure by **Support Wires** (*supplied by others*) through the **Grid Clip Hole** as shown in Fig. 3.
4. Make sure that the orientation of the **Splice Box** and **Access Plate** faces an accessible tile to make electrical splices.

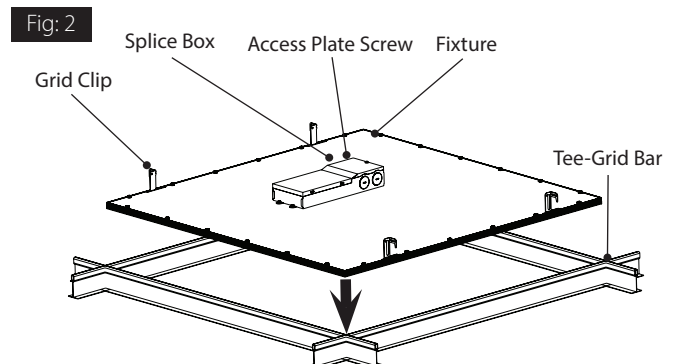
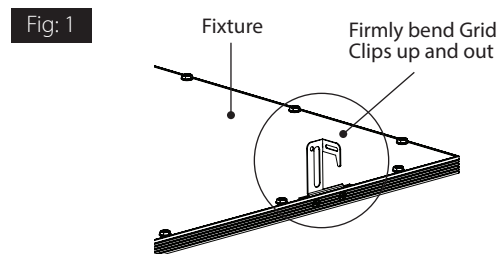

INSTALLATION INSTRUCTIONS

EZPAN® 1X4, 2X2, 2X4



RAB Lighting is committed to creating high-quality, affordable, well-designed and energy-efficient LED lighting and controls that make it easy for electricians to install and end users to save energy. We'd love to hear your comments. Please call the Marketing Department at 888-RAB-1000 or email: marketing@rablighting.com

RECESSED CEILING MOUNTING (CONT.)

- Loosen **Access Plate Screw** and remove the **Access Plate**. Knock out appropriate **Conduit Knockouts** on the **Access Plate** to route input conduit. Use appropriate conduit connectors as required by code (Fig. 4).
- Connect wires as shown in wiring diagram. Push all wires back into the **Splice Box**. Use appropriate UL approved wire connectors as required by code to complete wiring. Be careful not to pinch wires. **WARNING: To prevent wiring damage or abrasion, do not expose wiring to edges of sheet metal or other sharp objects.**
- Replace **Access Plate** and tighten **Access Plate Screw**.

0-10V DIMMABLE WIRING

Universal voltage driver permits operation at 120V through 277V, 50 or 60 Hz. For 0-10V dimming, follow the wiring directions as shown below (Fig. 5).

Do not use any supply voltage other than 120V-277V.

- Connect the black fixture lead to the **LINE** supply lead.
- Connect the white fixture lead to the **COMMON** supply lead.
- Connect the **GROUND** wire from fixture to supply **GROUND**.
- Connect the purple fixture lead to the (V+) DIM lead.
- Connect the pink (or gray) fixture lead to the (V-) DIM lead.

NOTE: Do not connect DIM V+ (purple)/ DIM V- (pink/gray) to line voltage or supply ground.

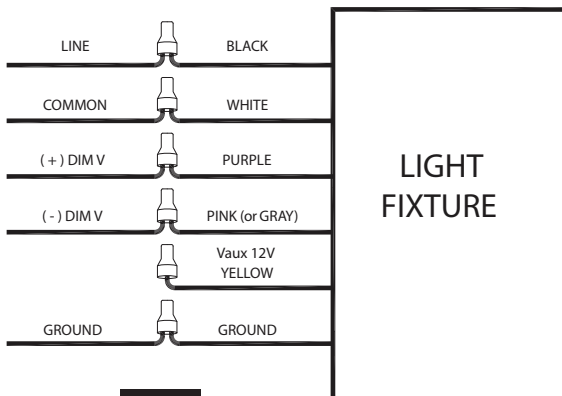

Fig. 5

Fig. 3

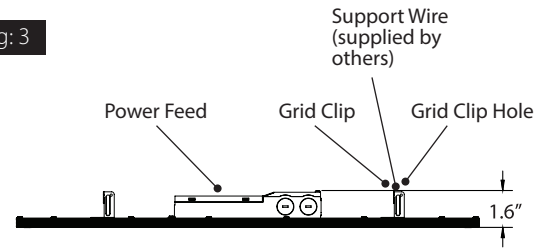
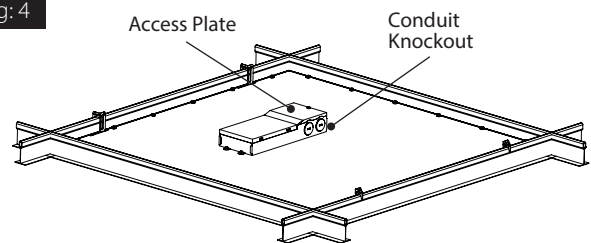

Fig. 4



CLEANING

CAUTION: Be sure fixture temperature is cool enough to touch. Do not clean or maintain while fixture is energized.

- Clean polystyrene lens & fixture with non-abrasive cleaning solution.
- Do not open fixture to clean the LEDs. Do not touch the LEDs.

TROUBLESHOOTING

- Check the line voltage at fixture. Refer to wiring directions.
- Is the fixture grounded properly?

INSTALLATION INSTRUCTIONS

EZPAN® 1X4, 2X2, 2X4



RAB Lighting is committed to creating high-quality, affordable, well-designed and energy-efficient LED lighting and controls that make it easy for electricians to install and end users to save energy. We'd love to hear your comments. Please call the Marketing Department at 888-RAB-1000 or email: marketing@rablighting.com

BATTERY BACKUP MODELS

WIRING

CAUTION: THIS IS A BATTERY BACKUP FIXTURE for standby lighting. Voltage could be present in Battery. To prevent high voltage from being present on output leads, inverter connector must be open. Do not join inverter connector until installation is complete and AC power is supplied to the emergency ballast.

Note: Make sure that the necessary branch circuit wiring is available. An unswitched AC source of power is required. The emergency ballast must be fed from the same branch circuit as the AC ballast (Fig. 6).

Do not use any supply voltage other than 120V-277V.

1. Connect the UNSWITCHED black fixture lead to the HOT supply lead.
2. If using an unswitched circuit, connect both black leads together.
3. If using a switched circuit, connect SWITCHED black lead to the switch.
4. Connect the COMMON fixture lead to the COMMON supply lead.
5. For 0-10V Dimming, connect DIM (+) purple lead and DIM (-) pink (or gray) lead to 0-10V dimmer connections on the driver.
6. Connect the GROUND wire from fixture to supply ground.
7. All unused leads must be capped and insulated.
8. After installation is complete, supply AC power to the emergency ballast and join the inverter connector.
9. At this point, power should be connected to both the AC ballast and the emergency ballast, the Charging Indicator Light should illuminate indicating the battery is charging.
10. A short duration discharge test may be conducted after the emergency ballast has been charging for one hour. Charge for 24 hours before conducting a 90-minute discharge test. Refer to OPERATION.

Fig. 6

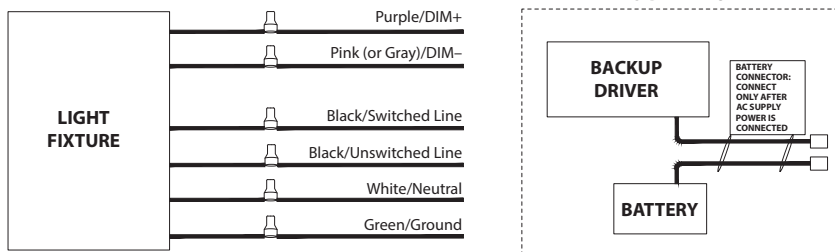

Note: These instructions do not cover all details or variations in equipment nor do they provide for every possible situation during installation, operation or maintenance.

OPERATION

1. When AC power is applied, the charging indicator light is illuminated, indicating that the battery is being charged.
2. When power fails, the emergency driver automatically switches to emergency power (*internal battery*), operating at reduced output. The emergency driver supplies 12W of power in emergency mode for a minimum of 90 minutes.
3. When AC power is restored, the emergency driver automatically returns to charging mode.

MAINTENANCE

Although no routine maintenance is required to keep the emergency driver functional, it should be checked periodically to ensure that it is working. The following schedule is recommended:

1. Visually inspect the charging indicator light monthly. It should be illuminated.
2. Test the emergency operation of the fixture at 30-day intervals for a minimum of 30 seconds.
3. Conduct a 90-minute discharge test once a year. Fixture would provide reduced illumination for a minimum of 90 minutes.

Battery Backup Setting		
PRODUCT	WATTAGE	DIP SWITCH POSITION (12W)
EZPAN 1X4	17	1 = Off 2 = On
EZPAN1X4	30, 40	
EZPAN 2X2	17	
EZPAN 2X2	30, 40	
EZPAN 2X4	30, 40, 50	