

# Blackburn Compression

Featuring the Color-Keyed® System

CATALOG NO. 256-30695-1117

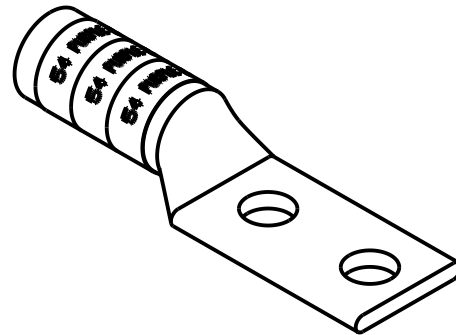
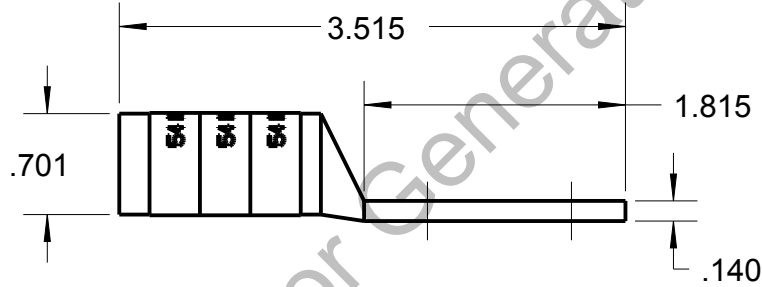
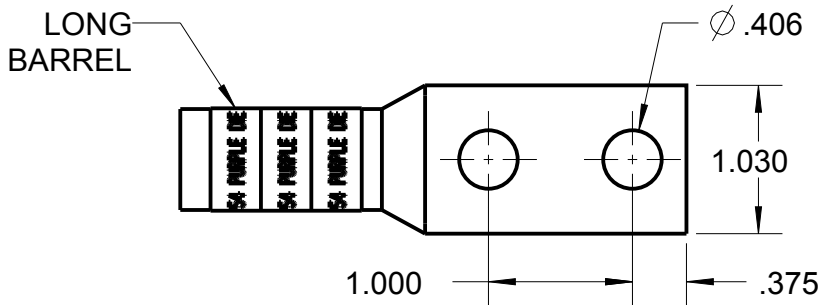

WIRE SIZE: 4/0  
 MATERIAL: HIGH CONDUCTIVITY COPPER  
 FINISH: TIN PLATED

GENERAL NOTES

1. ALL DIMENSIONS ARE FOR REFERENCE ONLY.
2. DIMENSIONS IN BRACKETS [ ] ARE IN METRIC UNITS.

REVISIONS

\*\* SEE ERN (\*\*\*\*)  
 FOR APPROVAL SIGNATURES  
 & RELEASE DATE.  
 PROJECT NO: \*\*\*\*

**Thomas & Betts**  
 www.tnb.com

DESCRIPTION:

2 HOLE LUG

ORIGINAL PROJECT NO / (ERN NO)

/ ( )

SHEET NO:

1 OF 1

REV. NO:

0

DRAWING NO: WSD-001919

256-30695-1117