



5" SHALLOW UNIVERSAL IC HOUSING

INCANDESCENT LAMPS
IC25 SERIES

Project: _____

Fixture Type: _____

Location: _____

Contact/Phone: _____

PRODUCT DESCRIPTION

IC Air-Loc® Housing • Energy efficient, sealed housing • Can be completely covered with insulation • When used with Air-Loc Gasket accessory or pre-installed gasket on mounting frame, stops infiltration and exfiltration of air, reducing heating and cooling costs • Trims shown with Air-Loc symbol **Air-Loc** do not require a gasket.

PRODUCT SPECIFICATIONS

Lamp Lamp ratings based on trim selected – see page 2.

Socket Medium base porcelain with nickel-plated copper screw shell • Floating socket with spring attaches to trim for installation.

Trims Trim selection shown on page 2.

Labels UL/cUL listed for through-branch wiring, damp locations and IP • Product thermally protected against improper use of lamps • Union made • UL and cUL Listed • Trim No. 212N is wet location approved for covered ceiling applications • Trims 275S and 276S are wet location approved for covered ceiling applications, **when used with outdoor rated PAR lamps.**

Testing All reports are based on published industry procedures; field performance may differ from laboratory performance. Specifications subject to change without notice.

INSTALLATION

Real Nail® Bar Hangers Telescoping, Patented (US Patent D552,969) Real Nail 3 and Real Nail 2 systems permits quick placement of housing anywhere within 24" O.C. joists or suspended ceilings • Bars scored in two locations for fast, clean breaking, allowing housing installation in tight applications • Bars captive to mounting frame • Edge-mounted for extra strength • Quick-Loc slot (location identified on the mounting frame) and oversized locking set screw lock fixture in position • May be installed either perpendicular or parallel to junction box.

Real Nail 3 Bar Hanger Integral T-bar notch and clip secures housing in suspended ceiling grid – no accessory clips required • 24" expansion stop allows quick placement of fixture in standard grid spacing • Captive bugle-headed ring shank nail for quick one-step installation and easy removal with claw hammer for fixture relocation • Bar hanger foot contoured to align to bottom of construction joist • Alternate mounting holes included.

Real Nail 2 Bar Hanger (S options) Small bar hanger foot designed to install directly on strapping construction material • Features Real Nail captive nail system for quick one-step installation • G2405 accessory clips required for suspended ceiling installation.

Junction Box Pre-wired junction box provided with (5) ½" and (1) ¾" knockouts, (4) Non-metallic sheathed cable connectors and ground wire, UL/cUL Listed for through branch wiring, maximum 8 No. 12 AWG 90° C branch circuit conductors (4 in, 4 out) • Junction box provided with removable access plates • Knockouts equipped with pryout slots • **W options** are supplied with **push-in electrical connectors** for fast installation.

Mounting Frame 22-gauge die-formed galvanized steel mounting frame • Rough-in section (junction box, mounting frame, housing and bar hangers) fully assembled for ease of installation • Sight lines embossed on mounting frame to allow for easy viewing when aligning fixtures • Pre-installed Air-Loc gasket for **G options**.

Housing IC housing, .032" aluminum sealed for Air-Loc Compliance • Housing is vertically adjustable to accommodate up to a 1" ceiling thickness.

DIMENSIONS

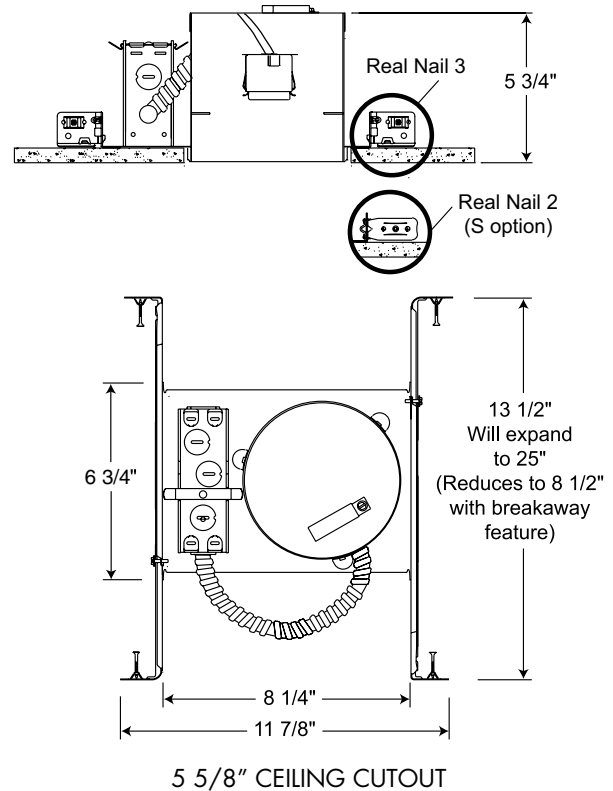

Accessories

Catalog Number	Description
ALG5	Air-Loc Gasket
G2405	T-Bar Clips (Set of 4), for S option only

To order, specify catalog number.

PRODUCT CODES

























Catalog Number	Input Voltage	Lamp Rating
IC25	120V	R20/PAR20/BR30/PAR30/PAR30L (See page 2 for max. trim rating)
IC25 G	120V	R20/PAR20/BR30/PAR30/PAR30L (See page 2 for max. trim rating)
IC25 S	120V	R20/PAR20/BR30/PAR30/PAR30L (See page 2 for max. trim rating)
IC25 S G	120V	R20/PAR20/BR30/PAR30/PAR30L (See page 2 for max. trim rating)
IC25 W	120V	R20/PAR20/BR30/PAR30/PAR30L (See page 2 for max. trim rating)
IC25 W G	120V	R20/PAR20/BR30/PAR30/PAR30L (See page 2 for max. trim rating)

Housing and trim can be ordered together or separate, but will always ship separately.

5" SHALLOW UNIVERSAL IC HOUSING

INCANDESCENT LAMPS IC25 SERIES

TRIMS/LAMPS

	Catalog Number	Description	Max. Lamp Rating	
	 275S BWH ◆◆ 275S WWH ◆◆	Shallow Black Baffle, White Trim Ring Shallow White Baffle, White Trim Ring	50W BR30, 50W PAR30, 50W PAR30L	
	 276S BWH ◆◆  276S CWH ◆◆  276S HZWH ◆◆  276S WHZWH ◆◆  276S WWH ◆◆	Shallow Black Cone, White Trim Ring Shallow Clear Alzak® Cone, White Trim Ring Shallow Haze Cone, White Trim Ring Shallow Wheat Haze Cone, White Trim Ring Shallow White Cone, White Trim Ring	50W BR30, 50W PAR30, 50W PAR30L	
	 208N BWH  208N WWH	Eyeball w/Black Baffle, White Trim Ring Eyeball w/White Baffle, White Trim Ring	50W PAR20/R20	
	 529 WH  529 SC  529 BRZ	Adjustable Eyeball, White Adjustable Eyeball, Satin Chrome Adjustable Eyeball, Bronze	50W PAR30	
	 209N WH	Gimbal Ring w/Flat Trim, White	35W PAR30, 35W PAR30L	
	 688 BWH  688 WWH	Gimbal Ring, Black Baffle, White Trim Ring Gimbal Ring, White Baffle, White Trim Ring	35W PAR30, 35W PAR30L	
	 689 CWH  689 GWH  689 WWH  689 HZWH  689 WHZWH	Gimbal Ring, Clear Alzak® Cone, White Trim Ring Gimbal Ring, Gold Cone, White Trim Ring Gimbal Ring, White Cone, White Trim Ring Gimbal Ring, Haze Cone, White Trim Ring Gimbal Ring, Wheat Haze Cone, White Trim Ring	35W PAR30, 35W PAR30L	
	 212N WH ◆  212N SC ◆  212N BRZ ◆	Frosted Lens with Clear Center Trim, White Frosted Lens with Clear Center Trim, Satin Chrome Frosted Lens with Clear Center Trim, Bronze	35W PAR30	

Trim Size: 6¼" O.D. (except Cat No. 529 - 6½" O.D.)
Alzak is a registered trademark of Alcoa Corp.
Note: In Canada when insulation is present,
Type IC fixtures must be used.

 JUNO IC housings meet IECC Energy Code requirements per ASTM E283.

Air-Loc® rated trims are pre-gasketed for minimum air leakage with IC housings.

◆ UL Listed for use in wet location.

◆◆ UL Listed for use in wet location with outdoor rated lamp.

Housing and trim can be ordered together or separate, but will always ship separately.