



NVENT CADDY ROD LOCK SPRING STEEL STRUT NUT, 1/2" ROD

CATALOG NUMBER

8QCN



The QCN combines the unique properties of Spring Steel and CADDY "push-to-install" technology to create a snap in place strut nut with shockingly quick install of threaded rod or bolts. Use with a hex nut on threaded rod for fast install of prefabricated trapeze systems or with a truss head bolt for unbelievably fast wall mounting of electrical boxes and other services.

FEATURES

Easy "push-to-install" design allows installers to simply push the threaded rod through the mounting hole, instantly holding it in position

Works with slightly damaged threads and minor burrs on the threaded rod

Perfect for quickly installing branch runs either at the load with standard strut or at the structure in combination with embedded strut

Integrated design eliminates the need for finicky spring nuts and loose hardware, simplifying installation

Quickly wall mount enclosures using common threaded bolts

Designed for use with standard strut widths (1 5/8" or 41mm) both shallow and deep profiles

PRODUCT ATTRIBUTES

Material: Spring Steel

Finish: nVent CADDY Armour

Rod Size (RS): 1/2"

Height (H): 0.67"

A: 1 1/2"

B: 1 1/2"

Static Load 1 (F1): 125lb

Static Load 2 (F2): 30lb

Static Load 3 (F3): 50lb

ADDITIONAL PRODUCT DETAILS

The QCN requires a longer bolt than standard strut nuts. See instruction sheet for detailed information.

In order to function properly on shallow strut (21mm or 13/16" deep), the QCN should be installed directly above a slot hole.

DIAGRAMS

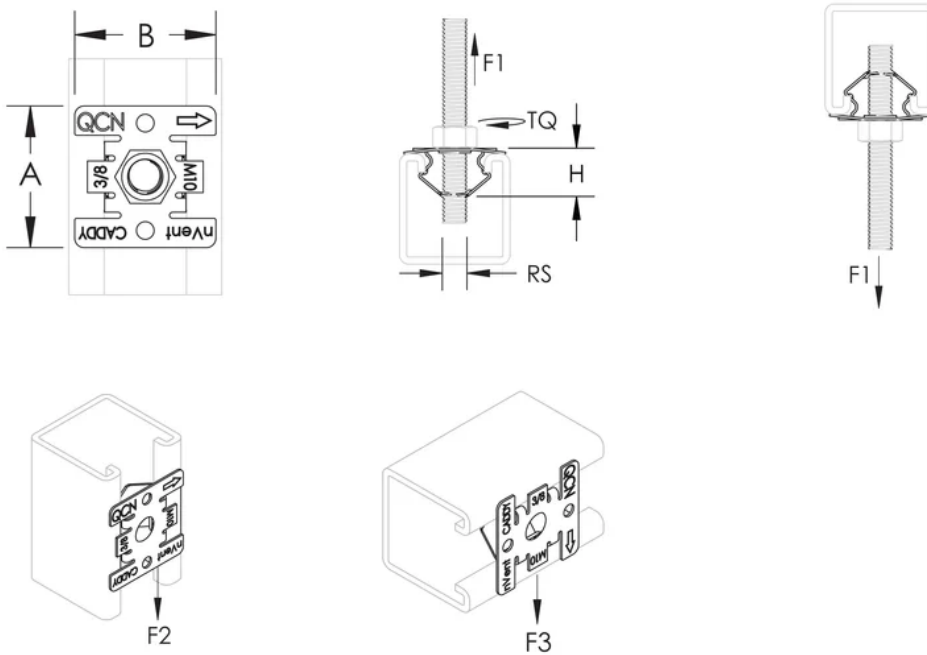

WARNING

nVent products shall be installed and used only as indicated in nVent's product instruction sheets and training materials. Instruction sheets are available at www.nvent.com and from your nVent customer service representative. Improper installation, misuse, misapplication or other failure to completely follow nVent's instructions and warnings may cause product malfunction, property damage, serious bodily injury and death and/or void your warranty.

North America

+1.800.753.9221

Option 1 – Customer Care

Option 2 – Technical Support

Europe

Netherlands:

+31 800-0200135

France:

+33 800 901 793

Europe

Germany:

800 1890272

Other Countries:

+31 13 5835404

APAC

Shanghai:

+ 86 21 2412 1618/19

Sydney:

+61 2 9751 8500



Our powerful portfolio of brands:
nVent.com CADDY ERICO HOFFMAN RAYCHEM SCHROFF
TRACER