

FEATURES & SPECIFICATIONS

INTENDED USE — Typical applications include corridors, lobbies, conference rooms and private offices.

CONSTRUCTION — Galvanized steel mounting/plaster frame; galvanized steel junction box with bottom-hinged access covers and spring latches. Reflectors are retained by torsion springs.

Vertically adjustable mounting brackets with commercial bar hangers provide 3-3/4" total adjustment.

Two combination 1/2"-3/4" and four 1/2" knockouts for straight-through conduit runs. Capacity: 8 (4 in, 4 out). No. 12 AWG conductors, rated for 90°C.

Accommodates 12"-24" joist spacing.

Passive cooling thermal management for 25°C standard; high ambient (40°C) option available. Light engine and drivers are accessible from above or below ceiling.

Max ceiling thickness 1-1/2".

OPTICS — LEDs are binned to a 3-step SDCM; 80 CRI minimum. 90 CRI optional.

LED light source concealed with diffusing optical lens.

General illumination lighting with 1.0 S/MH and 55° cutoff to source and source image.

Self-flanged anodized reflectors in specular, semi-specular, or matte diffuse finishes. Also available in white and black painted reflectors.

ELECTRICAL — Multi-volt (120-277V, 50/60Hz) 0-10V dimming drivers mounted to junction box, 10% or 1% minimum dimming level available.

0-10V dimming fixture requires two (2) additional low-voltage wires to be pulled.

70% lumen maintenance at 60,000 hours.

LISTINGS — Certified to US and Canadian safety standards. Wet location standard (covered ceiling). IP55 rated. ENERGY STAR® certified product.

BUY AMERICAN — Product with the BAA option is assembled in the USA and meets the Buy America(n) government procurement requirements under FAR, DFARS and DOT. Please refer to www.acuitybrands.com/buy-american for additional information.

WARRANTY — 5-year limited warranty. Complete warranty terms located at:

www.acuitybrands.com/support/warranty/terms-and-conditions

Note: Actual performance may differ as a result of end-user environment and application.

All values are design or typical values, measured under laboratory conditions at 25 °C.

Specifications subject to change without notice.

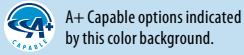

A+ Capable options indicated by this color background.

Catalog Number
Notes
Type

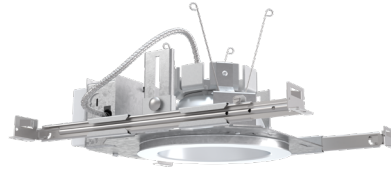

LDN6

6" Open and WallWash LED Non-IC New Construction Downlight



ORDERING INFORMATION

Lead times will vary depending on options selected. Consult with your sales representative.

Example: LDN6 35/15 L06AR LSS MVOLT EZ10

LDN6		Color temperature				Lumens ¹				Aperture/Trim Color			Finish		Voltage	
Series	LDN6 6" round	27/	2700K	05	500 lumens	25	2500 lumens	L06	Downlight	AR	Clear	LSS	Semi-specular	MVOLT	Multi-volt	
		30/	3000K	07	750 lumens	30	3000 lumens	LW6	Wallwash	WR ²	White	LD	Matte diffuse	120	120V	
		35/	3500K	10	1000 lumens	40	4000 lumens			BR ²	Black	LS	Specular	277	277V	
		40/	4000K	15	1500 lumens	50	5000 lumens							347 ³	347V	
		50/	5000K	20	2000 lumens											

Driver	Options		
GZ10 0-10V driver dims to 10%	SF ⁴ Single fuse	N80 ⁸ nLight™ Lumen Compensation	
GZ1 0-10V driver dims to 1%	TRW ⁵ White painted flange	JOT ¹³ Wireless room control with "Just One Touch" pairing	
D10 Minimum dimming 10% driver for use with JOT	TRBL ⁵ Black painted flange	NPS80EZ ⁷ nLight® dimming pack controls 0-10V eldoLED drivers (EZ10, EZ1).	
D1 Minimum dimming 1% driver for use with JOT	EL ⁶ Emergency battery pack with integral test switch. 10W Constant Power, Not Certified in CA Title 20 MAEDBS	NPS80EZER ⁷ nLight® dimming pack controls 0-10V eldoLED drivers (EZ10, EZ1). ER controls fixtures on emergency circuit.	
EZ10 0-10V eldoLED driver with smooth and flicker-free deep dimming performance down to 10%	ELR ⁶ Emergency battery pack with remote test switch. 10W Constant Power, Not Certified in CA Title 20 MAEDBS	HAO ¹¹ High ambient option	
EZ1 0-10V eldoLED driver with smooth and flicker-free deep dimming performance down to 1%	ELSD ⁶ Emergency battery pack with self-diagnostics, integral test switch. 10W Constant Power, Not Certified in CA Title 20 MAEDBS	CP ¹² Chicago Plenum	
EDAB eldoLED DALI SOLDRIVE dim to dark	ELRSD ⁶ Emergency battery pack with self-diagnostics, remote test switch. 10W Constant Power, Not Certified in CA Title 20 MAEDBS	RRL ^{___} RELOC-ready luminaire connectors enable a simple and consistent factory installed option across all ABL luminaire brands. Available only in RRLA, RRLB, RRLAE, and RRLC12S. Refer to RRL spec sheet on www.acuitybrands.com for the RELOC product specifications.	
	E10WCP ⁶ Emergency battery pack, 10W Constant Power with integral test switch. Certified in CA Title 20 MAEDB	NLTAIR2 ^{9,10} nLight® Air enabled	
	E10WCPR ⁶ Emergency battery pack, 10W Constant Power with remote test switch. Certified in CA Title 20 MAEDB	NLTAIRER2 ^{9,10} nLight® AIR Dimming Pack Wireless Controls. Controls fixtures on emergency circuit, not available with battery pack options	
	NPP16D ⁷ nLight® network power/relay pack with 0-10V dimming for non-eldoLED drivers (GZ10, GZ1).	NLTAIREM2 ^{9,10} nLight® AIR Dimming Pack Wireless Controls. UL924 Emergency Operation, via power interrupt detection. Available with battery pack options.	
	NPP16DER ⁷ nLight® network power/relay pack with 0-10V dimming for non-eldoLED drivers (GZ10, GZ1). ER controls fixtures on emergency circuit.	BAA Buy America(n) Act Compliant	
		90CRI High CRI (90+)	

Accessories: Order as separate catalog number.	
PS1055CP	FMC Power Sentry battery pack, T20 compliant, field installable, 10w constant power
EAC ISSM 375	Compact interruptible emergency AC power system
EAC ISSM 125	Compact interruptible emergency AC power system
GRA68 JZ	Oversized trim ring with 8" outside diameter
SCA6	Sloped Ceiling Adapter. Degree of slope must be specified (5D, 10D, 15D, 20D, 25D, 30D). Ex: SCA6 10D

- Notes**
- Overall height varies based on lumen package; refer to dimensional chart on page 3.
 - Not available with finishes.
 - Not available with emergency options.
 - Must specify voltage 120V or 277V.
 - Available with clear (AR) reflector only.
 - 12.5" of plenum depth or top access required for battery pack maintenance.
 - Specify voltage. ER for use with generator supply EM power. Will require an emergency hot feed and normal hot feed.
 - Fixture begins at 80% light level. Must be specified with NPS80EZ or NPS80EZ ER. Only available with EZ10 and EZ1 drivers.
 - Not available with CP, NPS80EZ, NPS80EZER, NPP16D, NPP16DER or N80 options.
 - NLTAIR2, NLTAIRER2 and NLTAIREM2 not recommended for metal ceiling installations.
 - Fixture height is 6.5" for all lumen packages with HAO.
 - Must specify voltage for 3000lm and above. 5000lm with marked spacing 24 L x 24 W x 14 H. Not available with emergency battery pack option.
 - Must specify D10 or D1 driver. Not available with nLight options. Not available with CP. Not recommended for metal ceiling installation. Not for use with emergency backup power systems other than battery packs.

LDN6

PHOTOMETRY

Distribution Curve Distribution Data Output Data Coefficient of Utilization Illuminance Data at 30" Above Floor for a Single Luminaire

LDN6 35/10 L06AR, input watts: 10.44, delivered lumens: 987.10, LM/W = 94.54, spacing criterion at 0= 1.02, test no. ISF 30716P262.

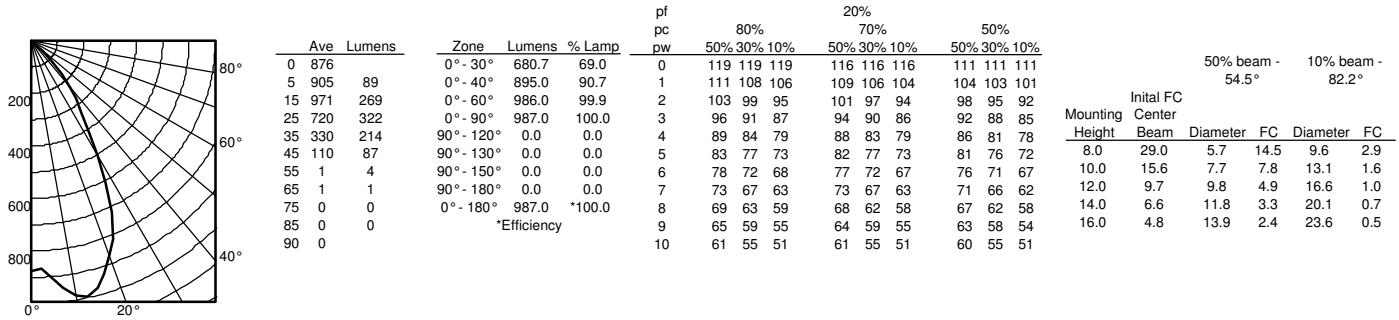

LDN6 35/15 L06AR, input watts: 17.52, delivered lumens: 1572.9, LM/W = 89.77, spacing criterion at 0= 1.02, test no. ISF 30716P265.

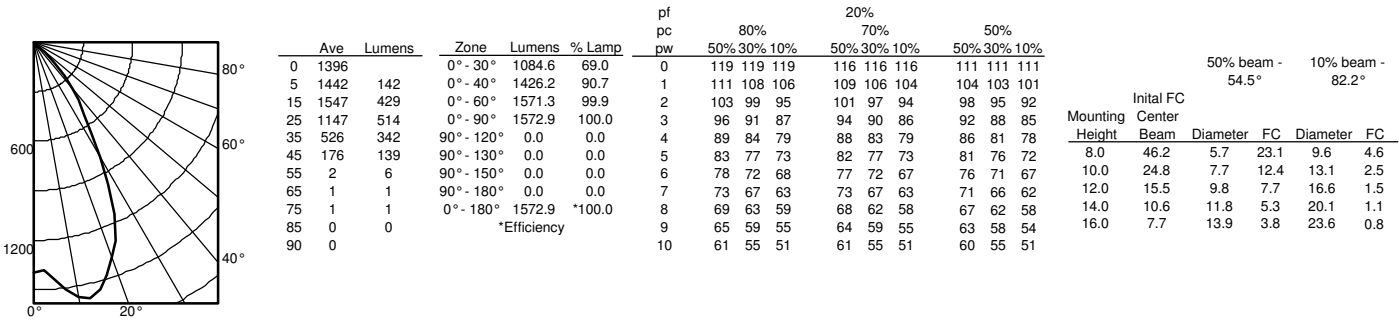

LDN6 35/30 L06AR, input watts: 34.75, delivered lumens: 3138.5, LM/W = 90.31, spacing criterion at 0= 1.02, test no. ISF 30716P274.

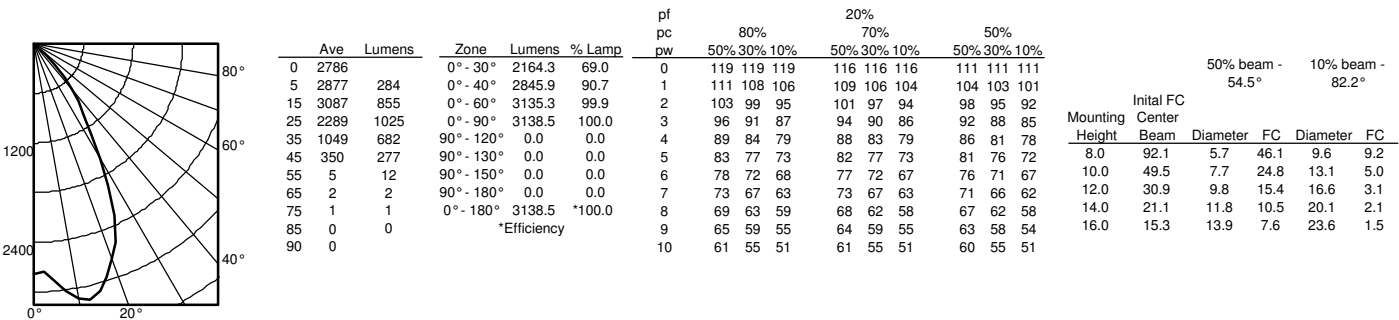

LDN6

* All dimensions are inches (centimeters) unless otherwise noted.

LDN6 500 - 1500 LUMENS

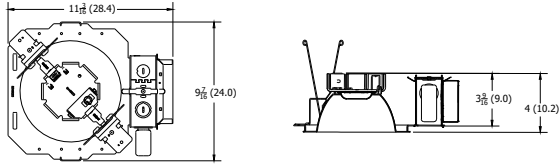

Aperture: 6-1/4 (15.9)
Ceiling Opening: 7-1/8 (18.1)
Overlap Trim: 7-1/2 (19.1)

LDN6 2000 - 3000 LUMENS

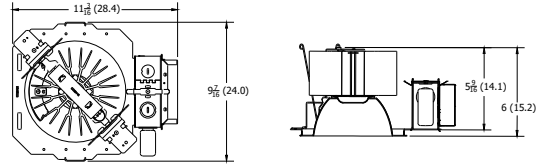

Aperture: 6-1/4 (15.9)
Ceiling Opening: 7-1/8 (18.1)
Overlap Trim: 7-1/2 (19.1)

LDN6 4000 - 5000 LUMENS

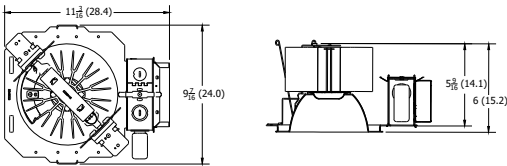

Marked Spacing: 24 x 24 x 10
Aperture: 6-1/4 (15.9)
Ceiling Opening: 7-1/8 (18.1)
Overlap Trim: 7-1/2 (19.1)

LDN6 CP

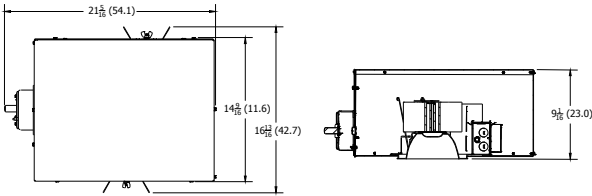

Aperture: 6-1/4 (15.9)
Ceiling Opening: 7-1/8 (18.1)
Overlap Trim: 7-1/2 (19.1)

LDN6 EL

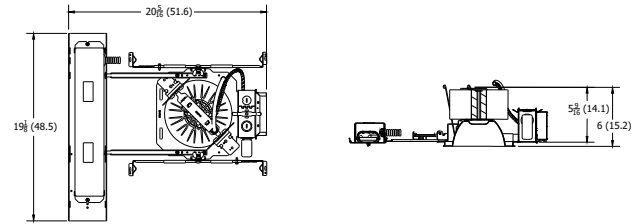

Marked Spacing above 3000 Lumens: 24 x 24 x 10
Aperture: 6-1/4 (15.9)
Ceiling Opening: 7-1/8 (18.1)
Overlap Trim: 7-1/2 (19.1)

LDN6			
Nominal Lumens	Lumens	Wattage	Lm/W
500	527.9	5.8	90.5
750	758.1	8.9	85.1
1000	950.1	10.4	91.0
1500	1514	17.5	86.4
2000	2006	22.5	89.1
2500	2504	28.3	88.6
3000	3021	34.8	86.9
4000	4008	44.3	90.6
5000	4975	57.7	86.3

HOW TO ESTIMATE DELIVERED LUMENS IN EMERGENCY MODE

Use the formula below to estimate the delivered lumens in emergency mode

$$\text{Delivered Lumens} = 1.25 \times P \times \text{LPW}$$

P = Output power of emergency driver. P = 10W for PS1055CP

LPW = Lumen per watt rating of the luminaire. This information is available on the ABL luminaire spec sheet.

The LPW rating is also available at Designlight Consortium.

LUMEN OUTPUT MULTIPLIERS - FINISH			
	Clear (AR)	White (WR)	Black (BR)
Specular (LS)	1.0	N/A	N/A
Semi-specular (LSS)	0.950	N/A	N/A
Matte diffuse (LD)	0.85	N/A	N/A
Painted	N/A	0.87	0.73

LUMEN OUTPUT MULTIPLIERS - CCT					
	2700K	3000K	3500K	4000K	5000K
80CRI	0.950	0.966	1.000	1.025	1.101

Notes

- Tested in accordance with IESNA LM-79-08.
- Tested to current IES and NEMA standards under stabilized laboratory conditions.
- CRI: 80 typical.

ADDITIONAL DATA



The Sensor Switch JOT enabled solution offers a wireless, app-free approach to single room lighting control. JOT enabled products use Bluetooth® Low Energy (BLE) technology to enable wireless dimming and switching.

Diagram

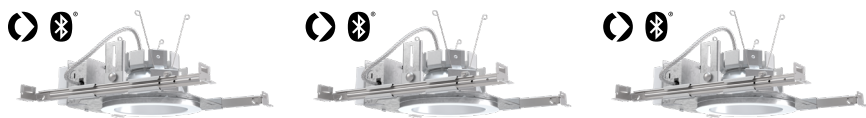

LDN6 Series



Sensor Switch
WSXA JOT

1. **Power:** Install JOT enabled fixtures and controls as instructed.
2. **Pair:** Insert the pairing tool into the pinhole on the wall switch; press and hold any button for 6 seconds.
3. **Play:** Once paired, each fixture will individually dim down to 10% brightness. All products will be fully functional.

COMPATIBLE 0-10V WALL-MOUNT DIMMERS		
MANUFACTURER	PART NO.	POWER BOOSTER AVAILABLE
Lutron®	Diva® DDTV	
	Diva® DVSCTV	
	Nova T® NTFTV	
	Nova® NFTV	
Leviton®	AWSMT-7DW	CN100
	AWSMG-7DW	PE300
	AMRMG-7DW	
	Leviton Centura Fluorescent Control System	
	IllumaTech® IP7 Series	
Synergy®	ISD BC	RDMFC
	SLD LPCS	
	Digital Equinox (DEQ BC)	
Douglas Lighting Controls	WPC-5721	
Entertainment Technology	Tap Glide TG600FAM120 (120V)	
	Tap Glide Heatsink TGH1500FAM120 (120V)	
	Oasis OA2000FAMU	
Honeywell	EL7315A1019	EL7305A1010 (optional)
	EL7315A1009	
HUNT Dimming	Preset slide: PS-010-IV and PS-010-WH	
	Preset slide: PS-010-3W-IV and PS-010-3W-WH	
	Preset slide, controls FD-010: PS-IFC-010-IV and PS-IFC-010-WH-120/277V	
	Preset slide, controls FD-010: PS-IFC-010-3W-IV and PS-IFC-010-3W-WH-120/277V	
	Remote mounted unit: FD-010	
Lehigh Electronic Products	Solitaire	PBX
PDM Electrical Products	WPC-5721	
Starfield Controls	TR61 with DALI interface port	RT03 DALI.net Router
WattStopper®	LS-4 used with LCD-101 and LCD-103	

A+ Capable Luminaire

This item is an A+ capable luminaire, which has been designed and tested to provide consistent color appearance and out-of-the-box control compatibility with simple commissioning.

- All configurations of this luminaire meet the Acuity Brands’ specification for chromatic consistency
- This luminaire is part of an A+ Certified solution for nLight® control networks when ordered with drivers marked by a shaded background*
- This luminaire is part of an A+ Certified solution for nLight control networks, providing advanced control functionality at the luminaire level, when selection includes driver and control options marked by a shaded background*

To learn more about A+, visit www.acuitybrands.com/aplus.

*See ordering tree for details

LDN6

EXAMPLE

Group Fixture Control*

*Application diagram applies for fixtures with eldoLED drivers only.

nPS 80 EZ Dimming/Control Pack (qty: 2 required)

nPODM 2P DX Dual On/Off/Dim Push-Button WallPod

nCM ADCX Daylight Sensor with Automatic Dimming Control

nCM PDT 9 Dual Technology Occupancy Sensor

Description: This design provides a dual on/off/dim wall station that enables manual control of the fixtures in Row A and Row B separately. Additionally, a daylight harvesting sensor is provided so the lights in Row B can be configured to dim automatically when daylight is available. An occupancy sensor turns off all lights when the space is vacant.

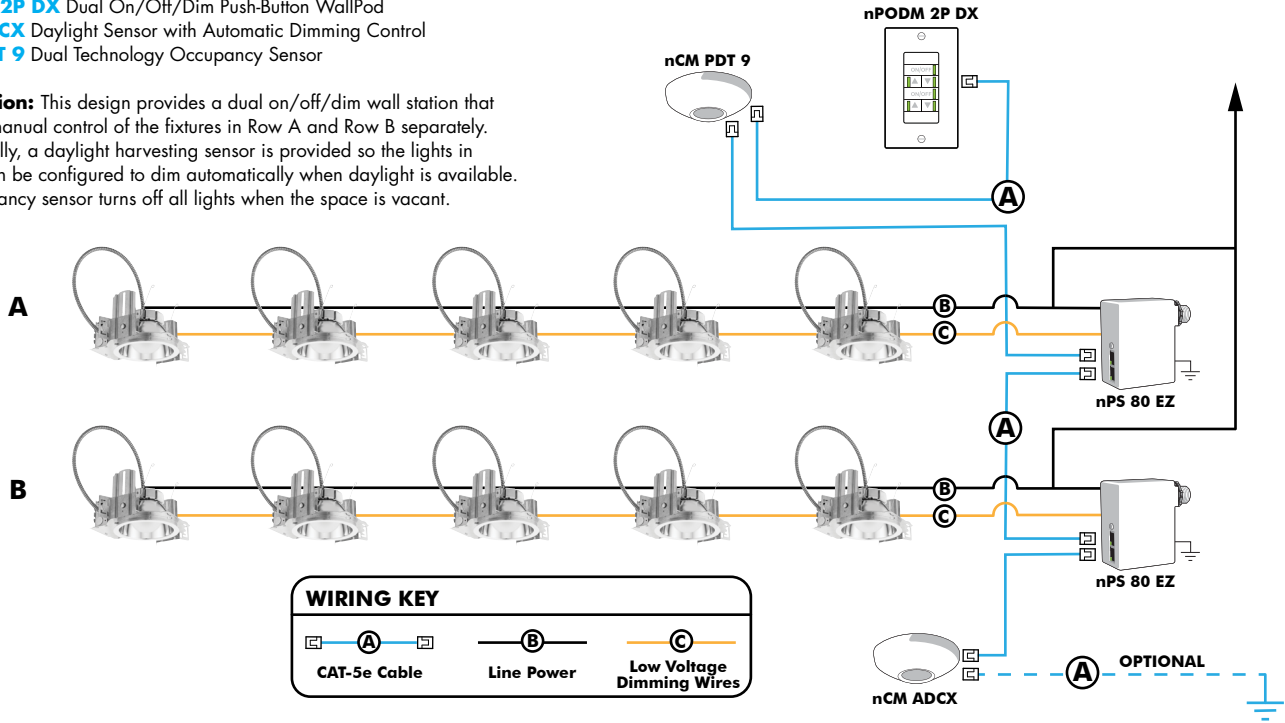

Choose Wall Controls

nLight offers multiple styles of wall controls - each with varying features and user experience.



Push-Button Wallpod
Traditional tactile buttons and LED user feedback



Graphic Wallpod
Full color touch screen provides a sophisticated look and feel

nLight® Wired Controls Accessories:

Order as separate catalog number. Visit www.acuitybrands.com/products/controls/nlight for complete listing of nLight controls.

WallPod Stations	Model number	Occupancy sensors	Model Number
On/Off	nPODM (Color)	Small motion 360°, ceiling (PIR/dual Tech)	nCM 9 / nCM PDT 9
On/Off & Raise/Lower	nPOD DX (Color)	Large motion 360°, ceiling (PIR/dual tech)	nCM 10 / nCM PDT 10
Graphic Touchscreen	nPOD GFX (Color)	Wide View (PIR/dual tech)	nWV 16 / nWV PDT 16
Photocell controls	Model Number	Wall Switch w/ Raise/Lower (PIR/dual tech)	nWSX LV DX / nWSX PDT LV DX
Dimming	nCM ADCX	Cat-5 cables (plenum rated)	Model Number
		10', CAT5 10FT	CAT5 10FT J1
		15', CAT5 15FT	CAT5 15FT J1

nLight® AIR Control Accessories:

Order as separate catalog number. Visit www.acuitybrands.com/products/controls/nlightair.

Wall switches	Model number
On/Off single pole	rPODB [color]
On/Off two pole	rPODB 2P [color]
On/Off & raise/lower single pole	rPODB DX [color]
On/Off & raise/lower two pole	rPODB 2P DX [color]
On/Off & raise/lower single pole	rPODBZ DX WH ¹

Notes

1 Can only be ordered with the RES7Z zone control sensor version.

nLight AIR

nLight AIR is the ideal solution for retrofit or new construction spaces where adding communication is cost prohibitive. The integrated nLight AIR rPP20 Power Pack is part of each Lithonia LDN Luminaire. These individually addressable controls offer the ultimate in flexibility during initial setup and for space repurposing.



Simple as 1,2,3

1. Install the nLight® AIR fixtures with embedded smart sensor
2. Install the wireless battery-powered wall switch
3. With CLAIRITY app, pair the fixtures with the wall switch and if desired, customize the sensor settings for the desired outcome

