

FEATURES & SPECIFICATIONS

INTENDED USE — Typical applications include corridors, lobbies, conference rooms and private offices.

CONSTRUCTION — Galvanized steel mounting/plaster frame; galvanized steel junction box with bottom-hinged access covers and spring latches. Reflectors are retained by torsion springs.

Vertically adjustable mounting brackets with commercial bar hangers provide 3-3/4" total adjustment.

Two combination 1/2"-3/4" and four 1/2" knockouts for straight-through conduit runs. Capacity: 8 (4 in, 4 out). No. 12 AWG conductors, rated for 90°C.

Accommodates 12"-24" joist spacing.

Passive cooling thermal management for 25°C standard; high ambient (40°C) option available. Light engine and drivers are accessible from above or below ceiling.

Max ceiling thickness 1-1/2".

OPTICS — LEDs are binned to a 3-step SDCM; 80 CRI minimum. 90 CRI optional.

LED light source concealed with diffusing optical lens.

General illumination lighting with 1.0 S/MH and 55° cutoff to source and source image.

Self-flanged anodized reflectors in specular, semi-specular, or matte diffuse finishes. Also available in white and black painted reflectors.

ELECTRICAL — Multi-volt (120-277V, 50/60Hz) 0-10V dimming drivers mounted to junction box, 10% or 1% minimum dimming level available.

0-10V dimming fixture requires two (2) additional low-voltage wires to be pulled.

70% lumen maintenance at 60,000 hours.

LISTINGS — Certified to US and Canadian safety standards. Wet location standard (covered ceiling). IP55 rated. ENERGY STAR® certified product.

BUY AMERICAN — Product with the BAA option is assembled in the USA and meets the Buy America(n) government procurement requirements under FAR, DFARS and DOT.

Please refer to www.acuitybrands.com/buy-american for additional information.

WARRANTY — 5-year limited warranty. Complete warranty terms located at: www.acuitybrands.com/support/warranty/terms-and-conditions

Note: Actual performance may differ as a result of end-user environment and application. All values are design or typical values, measured under laboratory conditions at 25 °C. Specifications subject to change without notice.

A+ Capable options indicated by this color background.

Catalog Number
Notes
Type



LDN4

4" Open and WallWash LED Non-IC New Construction Downlight



ORDERING INFORMATION

Lead times will vary depending on options selected. Consult with your sales representative.

Example: LDN4 35/15 L04AR LSS MVOLT EZ1

LDN4 Series	Color temperature	Lumens ¹	Aperture/Trim Color	Finish	Voltage	
LDN4 4" round	27/ 2700K	05 500 lumens	L04 Downlight LW4 Wallwash	AR Clear WR ² White BR ² Black	LSS Semi-specular LD Matte diffuse LS Specular	
	30/ 3000K	20 2000 lumens				MVOLT Multi-volt
	35/ 3500K	25 2500 lumens				120 120V
	40/ 4000K	30 3000 lumens				277 277V
	50/ 5000K	40 4000 lumens				347 ³ 347V

Driver	Options
GZ10 0-10V driver dims to 10%	SF ⁴ Single fuse
GZ1 0-10V driver dims to 1%	TRW ⁶ White painted flange
EZ10 0-10V eldoLED driver with smooth and flicker-free deep dimming performance down to 10%	TRBL ⁶ Black painted flange
	EL ⁵ Emergency battery pack with integral test switch. 10W Constant Power, Not Certified in CA Title 20 MAEDBS
EZ1 0-10V eldoLED driver with smooth and flicker-free deep dimming performance down to 1%	ELR ⁵ Emergency battery pack with remote test switch. 10W Constant Power, Not Certified in CA Title 20 MAEDBS
	ELSD ⁵ Emergency battery pack with self-diagnostics, 10W Constant Power, integral test switch. Not Certified in CA Title 20 MAEDBS
D10 Minimum dimming 10% driver for use with JOT	ELRSD ⁵ Emergency battery pack with self-diagnostics, 10W Constant Power, remote test switch. Not Certified in CA Title 20 MAEDBS
D1 Minimum dimming 1% driver for use with JOT	E10WCP ⁵ Emergency battery pack, 10W Constant Power with integral test switch. Certified in CA Title 20 MAEDBS
EDAB eldoLED DALI SOLDRIVE dim to dark	E10WCP ⁵ Emergency battery pack, 10W Constant Power with remote test switch. Certified in CA Title 20 MAEDBS
	NPP16D ⁷ nLight® network power/relay pack with 0-10V dimming for non-eldoLED drivers (GZ10, GZ1).
	NPP16DER ⁷ nLight® network power/relay pack with 0-10V dimming for non-eldoLED drivers (GZ10, GZ1). ER controls fixtures on emergency circuit.
	N80 ⁸ nLight™ Lumen Compensation
	JOT ¹³ Wireless room control with "Just One Touch" pairing
	NPS80EZ ⁷ nLight® dimming pack controls 0-10V eldoLED drivers (EZ10, EZ1).
	NPS80EZER ⁷ nLight® dimming pack controls 0-10V eldoLED drivers (EZ10, EZ1). ER controls fixtures on emergency circuit.
	HAO ¹¹ High ambient option (40°C)
	CP ¹² Chicago Plenum
	RRL___ RELOC®-ready luminaire connectors enable a simple and consistent factory installed option across all ABL luminaire brands. Refer to RRL for complete nomenclature. Available only in RRLA, RRLB, RRLAE, and RRLC125.
	NLTAIR2 ^{9,10} nLight® Air enabled
	NLTAIRER2 ^{9,10} nLight® AIR Dimming Pack Wireless Controls. Controls fixtures on emergency circuit, not available with battery pack options
	NLTAIREM2 ^{9,10} nLight® AIR Dimming Pack Wireless Controls. UL924 Emergency Operation, via power interrupt detection. Available with battery pack options.
	BAA Buy America(n) Act Compliant
	90CRI High CRI (90+)

Accessories: Order as separate catalog number.

PS1055CP	FMC Power Sentry battery pack, T20 compliant, field installable, 10w constant power
EAC ISSM 375	Compact interruptible emergency AC power system
EAC ISSM 125	Compact interruptible emergency AC power system
GRA46 JZ	Oversized trim ring with 6" outside diameter
SCA4	Sloped Ceiling Adapter. Degree of slope must be specified (5D, 10D, 15D, 20D, 25D, 30D). Ex: SCA4 10D.

Notes

- Overall height varies based on lumen package; refer to dimensional chart on page 3.
- Not available with finishes.
- Not available with emergency options.
- Must specify voltage 120V or 277V.
- 12.5" of plenum depth or top access required for battery pack maintenance.
- Available with clear (AR) reflector only.
- Specify voltage. ER for use with generator supply EM power. Will require an emergency hot feed and normal hot feed.
- Fixture begins at 80% light level. Must be specified with NPS80EZ or NPS80EZ ER. Only available with EZ10 and EZ1 drivers.
- Not available with CP, NPS80EZ, NPS80EZER, NPP16D, NPP16DER or N80 options.
- NLTAIR2, NLTAIRER2 and NLTAIREM2 not recommended for metal ceiling installations.
- Fixture height is 5-11/16" for all lumen packages with HAO.
- Must specify voltage for 3000lm. Not available with emergency battery pack option.
- Must specify D10 or D1 driver. Not available with nLight options. Not available with CP. Not recommended for metal ceiling installation. Not for use with emergency backup power systems other than battery packs.

LDN4

PHOTOMETRY

Distribution Curve	Distribution Data	Output Data	Coefficient of Utilization	Illuminance Data at 30" Above Floor for a Single Luminaire
--------------------	-------------------	-------------	----------------------------	--

LDN4 35/10 L04AR, input watts: 10.58, delivered lumens: 1085.2, LM/W = 102.57, spacing criterion at 0= 1.04, test no. ISF 30712P229.

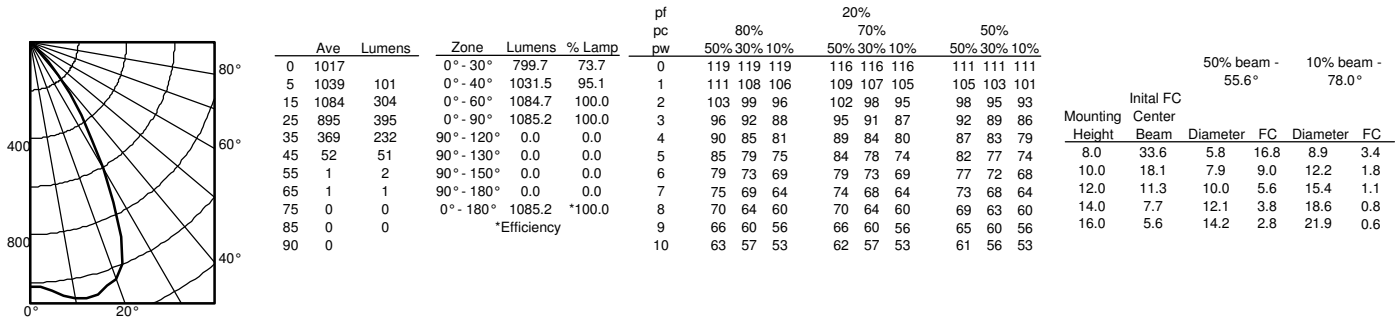

LDN4 35/15 L04AR, input watts: 17.5, delivered lumens: 1570.1, LM/W = 89.72, spacing criterion at 0= 1.04, test no. ISF 30712P234.

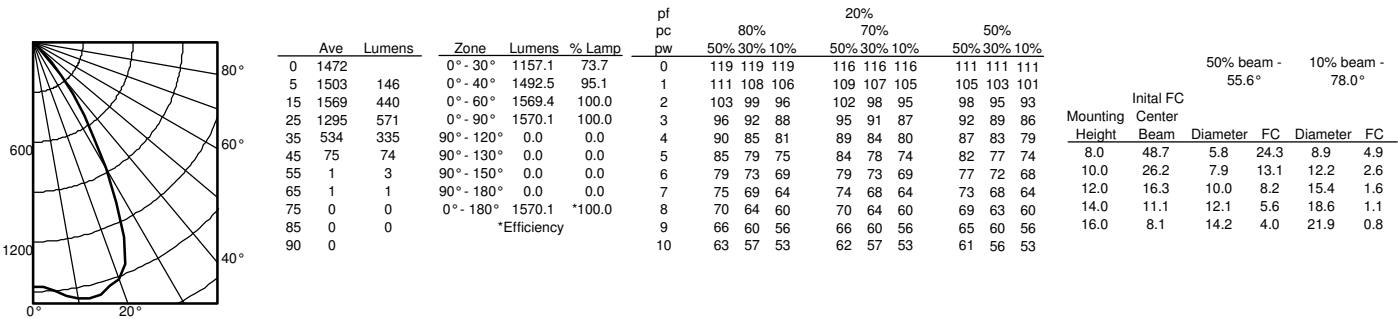

LDN4 35/30 L04AR, input watts: 32.1, delivered lumens: 3122.6, LM/W = 88.52, spacing criterion at 0= 1.04, test no. ISF 30712P249.

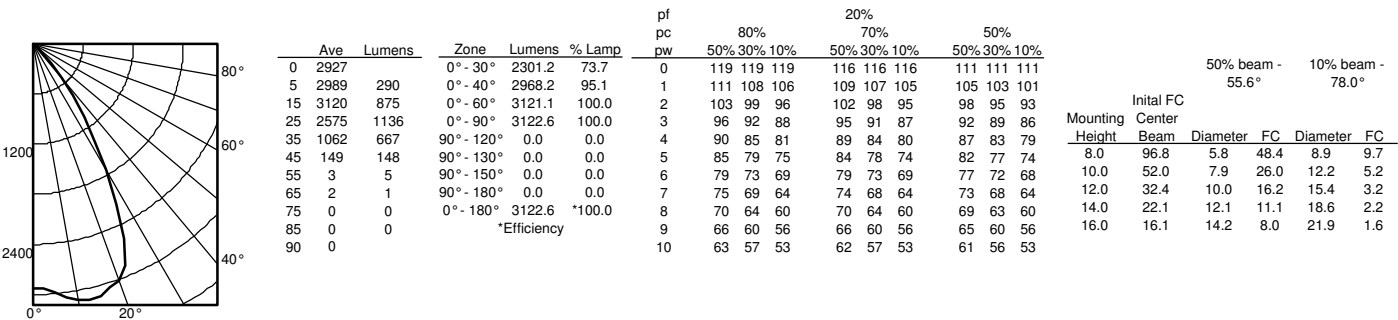

LDN4

* All dimensions are inches (centimeters) unless otherwise noted.

LDN4 500 - 2000 LUMENS

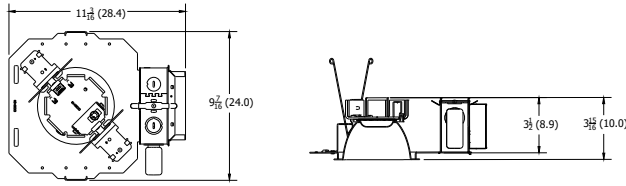

Aperture: 4-5/16" (11)
Ceiling Opening: 5-1/8" (13)
Overlap Trim: 5-7/16" (13.8)

LDN4 2500 - 4000 LUMENS

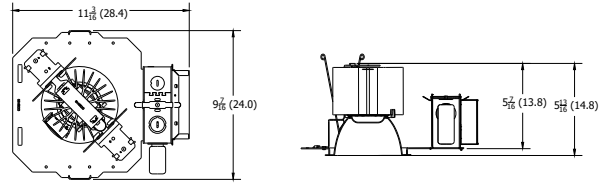

Aperture: 4-5/16" (11)
Ceiling Opening: 5-1/8" (13)
Overlap Trim: 5-7/16" (13.8)

LDN4 CP

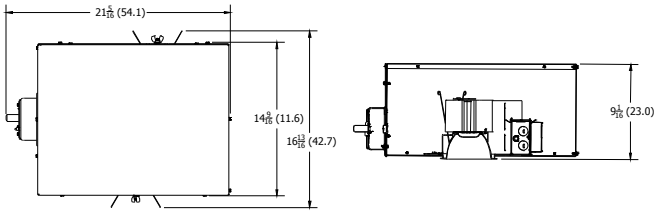

Aperture: 4-5/16" (11)
Ceiling Opening: 5-1/8" (13)
Overlap Trim: 5-7/16" (13.8)

LDN4 EL

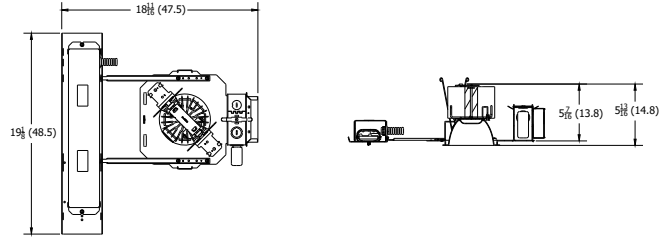

Aperture: 4-5/16" (11)
Ceiling Opening: 5-1/8" (13)
Overlap Trim: 5-7/16" (13.8)

LDN4			
Nominal	Lumens	Wattage	Lm/W
500	523.6	5.74	91.2
750	751.1	8.6	87.3
1000	1045	10.58	98.8
1500	1512	17.5	86.4
2000	2006	22.12	90.7
2500	2551	26.1	97.7
3000	3007	32.1	93.7
4000	4212	43	98.0

LUMEN OUTPUT MULTIPLIERS - CCT					
	2700K	3000K	3500K	4000K	5000K
80CRI	0.950	0.966	1.000	1.025	1.101

HOW TO ESTIMATE DELIVERED LUMENS IN EMERGENCY MODE

Use the formula below to estimate the delivered lumens in emergency mode

$$\text{Delivered Lumens} = 1.25 \times P \times \text{LPW}$$

P = Output power of emergency driver. P = 10W for PS1055CP

LPW = Lumen per watt rating of the luminaire. This information is available on the ABL luminaire spec sheet.

The LPW rating is also available at Designlight Consortium.

LUMEN OUTPUT MULTIPLIERS - FINISH

	Clear (AR)	White (WR)	Black (BR)
Specular (LS)	1.0	N/A	N/A
Semi-specular (LSS)	0.950	N/A	N/A
Matte diffuse (LD)	0.85	N/A	N/A
Painted	N/A	0.87	0.73

Notes

- Tested in accordance with IESNA LM-79-08.
- Tested to current IES and NEMA standards under stabilized laboratory conditions.
- CRI: 80 typical.

ADDITIONAL DATA

JOT

JUST ONE TOUCH

The Sensor Switch JOT enabled solution offers a wireless, app-free approach to single room lighting control. JOT enabled products use Bluetooth® Low Energy (BLE) technology to enable wireless dimming and switching.

Diagram



LDN4 Series



Sensor Switch
WSXA JOT

- Power:** Install JOT enabled fixtures and controls as instructed.
- Pair:** Insert the pairing tool into the pinhole on the wall switch; press and hold any button for 6 seconds.
- Play:** Once paired, each fixture will individually dim down to 10% brightness. All products will be fully functional.

COMPATIBLE 0-10V WALL-MOUNT DIMMERS

MANUFACTURER	PART NO.	POWER BOOSTER AVAILABLE
Lutron®	Diva® DDTV	
	Diva® DVSCTV	
	Nova T® NTFTV	
	Nova® NFTV	
Leviton®	AWSMT-7DW	CN100
	AWSMG-7DW	PE300
	AMRMG-7DW	
	Leviton Centura Fluorescent Control System	
	IllumaTech® IP7 Series	
Synergy®	ISD BC	RDMFC
	SLD LPCS	
	Digital Equinox (DEQ BC)	
Douglas Lighting Controls	WPC-5721	
Entertainment Technology	Tap Glide TG600FAM120 (120V)	
	Tap Glide Heatsink TGH1500FAM120 (120V)	
	Oasis OA2000FAMU	
Honeywell	EL7315A1019	EL7305A1010 (optional)
	EL7315A1009	
HUNT Dimming	Preset slide: PS-010-IV and PS-010-WH	
	Preset slide: PS-010-3W-IV and PS-010-3W-WH	
	Preset slide, controls FD-010: PS-IFC-010-IV and PS-IFC-010-WH-120/277V	
	Preset slide, controls FD-010: PS-IFC-010-3W-IV and PS-IFC-010-3W-WH-120/277V	
	Remote mounted unit: FD-010	
Lehigh Electronic Products	Solitaire	PBX
PDM Electrical Products	WPC-5721	
Starfield Controls	TR61 with DALI interface port	RT03 DALInet Router
WattStopper®	LS-4 used with LCD-101 and LCD-103	

A+ Capable Luminaire

This item is an A+ capable luminaire, which has been designed and tested to provide consistent color appearance and out-of-the-box control compatibility with simple commissioning.

- All configurations of this luminaire meet the Acuity Brands' specification for chromatic consistency
- This luminaire is part of an A+ Certified solution for nLight® control networks when ordered with drivers marked by a **shaded background***
- This luminaire is part of an A+ Certified solution for nLight control networks, providing advanced control functionality at the luminaire level, when selection includes driver and control options marked by a **shaded background***

To learn more about A+, visit www.acuitybrands.com/aplus.

*See ordering tree for details

LDN4

EXAMPLE

Group Fixture Control*

*Application diagram applies for fixtures with eldoLED drivers only.

nPS 80 EZ Dimming/Control Pack (qty: 2 required)

nPODM 2P DX Dual On/Off/Dim Push-Button WallPod

nCM ADCX Daylight Sensor with Automatic Dimming Control

nCM PDT 9 Dual Technology Occupancy Sensor

Description: This design provides a dual on/off/dim wall station that enables manual control of the fixtures in Row A and Row B separately. Additionally, a daylight harvesting sensor is provided so the lights in Row B can be configured to dim automatically when daylight is available. An occupancy sensor turns off all lights when the space is vacant.

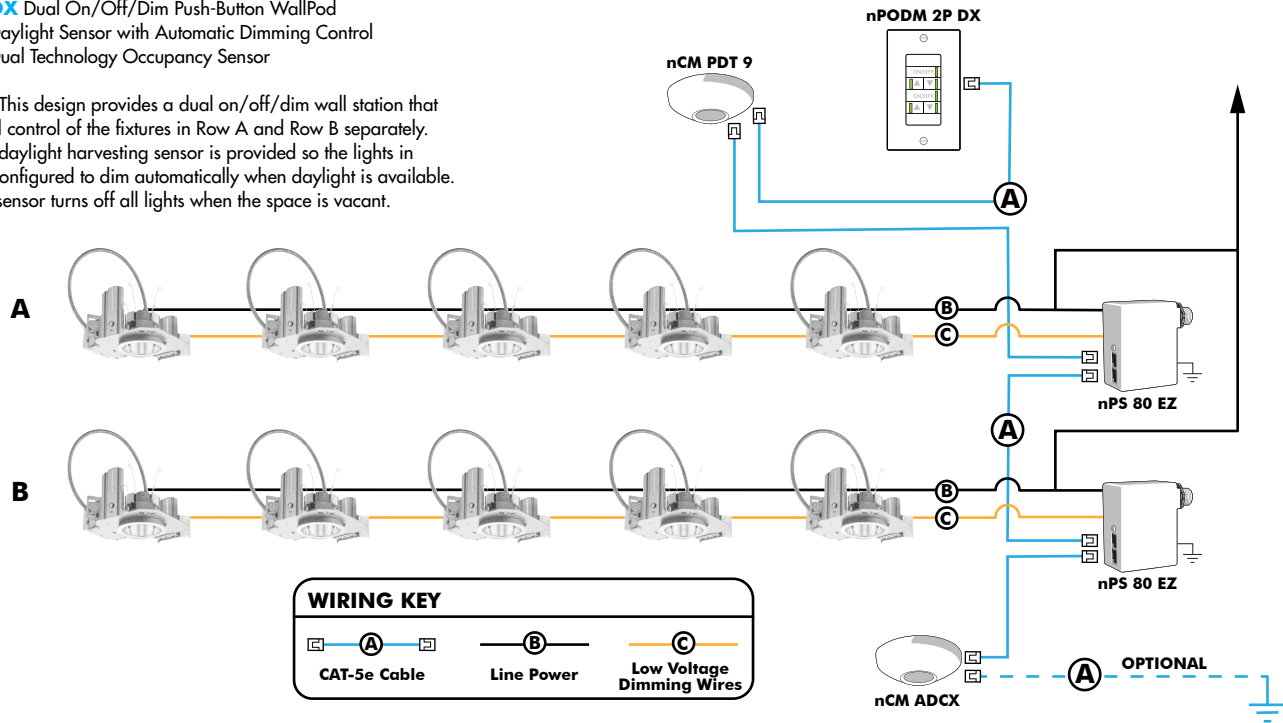

Choose Wall Controls

nLight offers multiple styles of wall controls - each with varying features and user experience.



Push-Button Wallpod

Traditional tactile buttons and LED user feedback



Graphic Wallpod

Full color touch screen provides a sophisticated look and feel

nLight® Wired Controls Accessories:

Order as separate catalog number. Visit www.acuitybrands.com/products/controls/nlight for complete listing of nLight controls.

WallPod Stations	Model number	Occupancy sensors	Model Number
On/Off	nPODM (Color)	Small motion 360°, ceiling (PIR/dual Tech)	nCM 9 / nCM PDT 9
On/Off & Raise/Lower	nPOD DX (Color)	Large motion 360°, ceiling (PIR/dual tech)	nCM 10 / nCM PDT 10
Graphic Touchscreen	nPOD GFX (Color)	Wide View (PIR/dual tech)	nWV 16 / nWV PDT 16
Photocell controls	Model Number	Wall Switch w/ Raise/Lower (PIR/dual tech)	nWSX LV DX / nWSX PDT LV DX
Dimming	nCM ADCX	Cat-5 cables (plenum rated)	Model Number
		10', CAT5 10FT	CAT5 10FT J1
		15, CAT5 15FT	CAT5 15FT J1

nLight® AIR Control Accessories:

Order as separate catalog number. Visit www.acuitybrands.com/products/controls/nlightair.

Wall switches

	Model number
On/Off single pole	rPODB [color]
On/Off two pole	rPODB 2P [color]
On/Off & raise/lower single pole	rPODB DX [color]
On/Off & raise/lower two pole	rPODB 2P DX [color]
On/Off & raise/lower single pole	rPODBZ DX WH ¹

Notes

¹ Can only be ordered with the RES7Z zone control sensor version.

nLight AIR

nLight AIR is the ideal solution for retrofit or new construction spaces where adding communication is cost prohibitive. The integrated nLight AIR rPP20 Power Pack is part of each Lithonia LDN Luminaire. These individually addressable controls offer the ultimate in flexibility during initial setup and for space repurposing.

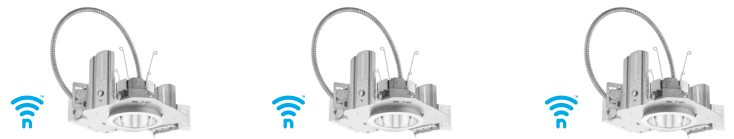

Simple as 1,2,3

1. Install the nLight® AIR fixtures with embedded smart sensor
2. Install the wireless battery-powered wall switch
3. With CLAIRITY app, pair the fixtures with the wall switch and if desired, customize the sensor settings for the desired outcome

