

Project		Catalog #		Type	
Prepared by		Notes		Date	

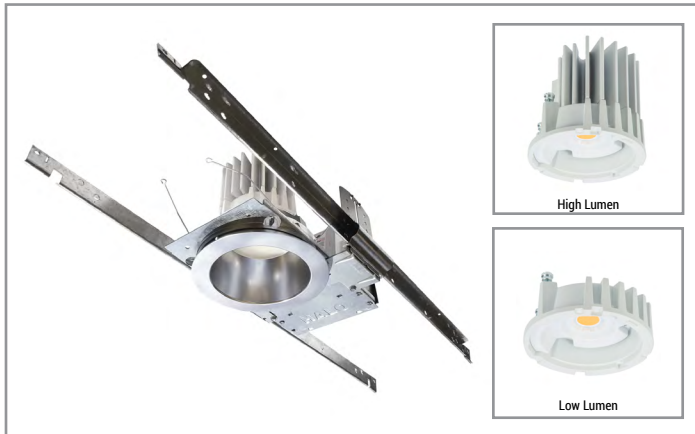

HALO Commercial

HC4 | HM4 | 41/41PS

4-inch LED new construction/remodel regressed lens downlight and wall wash

Typical Applications

Office • Healthcare • Hospitality • Institutional • Mixed-Use/Retail

Interactive Menu

- Order Information [page 2](#)
- Product Specifications [page 4](#)
- Photometric Data [page 5](#)
- Energy & Performance Data [page 8](#)
- Connected Systems [page 9](#)
- Product Warranty

Product Certification



Product Features



Top Product Features

- New construction/remodel series; 1,000 to 4,000 lumens
- Narrow, Medium and Wide distributions; Wall wash with rotatable linear spread lens
- 2700K, 3000K, 3500K and 4000K CCT; 80 or 90 CRI
- Universal voltage 120V-277V; Standard 0-10V driver dims to 1%
- Retrofit kits installs from below ceiling for LED upgrades

Dimensional and Mounting Details

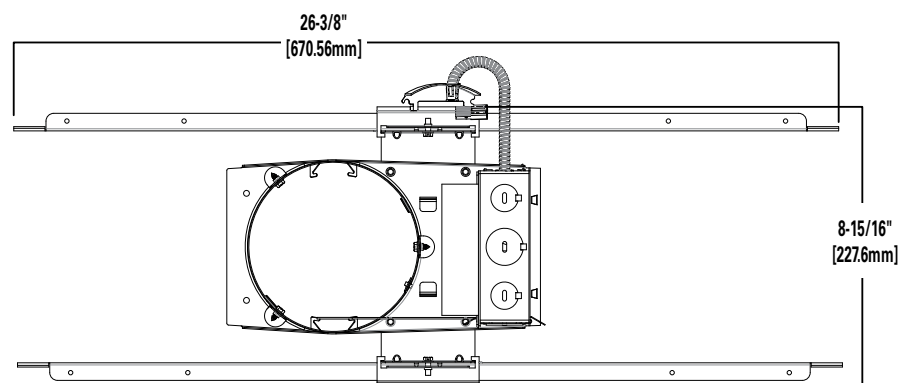

[additional product diagrams](#)

Order Information

Sample Number : HC420D010REM7 - HM412835 - 41MDC

A complete luminaire consists of a housing frame, LED module, and reflector (ordered separately)

Mounting Frame	Lumens	Input / Control	Factory Installed Options	Accessories
<p>HC4 = 4" new construction and remodeler housing</p> <p>HC4CP = 4" new construction and remodeler housing, CCEA Chicago Plenum rated</p>	<p>10 = 1000 lumens (nominal)</p> <p>15 = 1500 lumens (nominal)</p> <p>20 = 2000 lumens (nominal)</p> <p>30 = 3000 lumens (nominal)</p> <p>40 = 4000 lumens (nominal)</p>	<p>D010=120-277VAC 50/60Hz 0-10V analog 1% - 100% dimming</p> <p>D010347 = 347VAC 50/60Hz 0-10V analog 1%-100% dimming (Canada only) ⁽¹⁾</p> <p>DLV = Distributed Low Voltage driver, 1%-100% dimming DLV for use with DLVP system only. Refer to DLVP low-voltage power module and DLVP specifications for details. ⁽¹⁾</p>	<p>REM7 = 7 watt emergency module with remote test / indicator light, use with D010 only ⁽¹⁾</p> <p>REM14 = 14 watt emergency module with remote test / indicator light, use with D010 only ⁽¹⁾</p> <p>IEM7 = integral 7 watt emergency module with integral test / indicator light, use with D010 only ⁽¹⁾</p> <p>IEM14 = integral 14 watt emergency module with integral test / indicator light, use with D010 only ⁽¹⁾</p> <p>BOD7ST = 7.5 watt Bodine self-test diagnostic emergency module with remote test / indicator light, use with D010 only ⁽¹⁾</p> <p>WTA=Factory installed WaveLinX sensor Kit ⁽¹⁾⁽⁵⁾</p> <p>WTK = Factory installed WaveLinX Lite Sensor Kit ⁽⁶⁾</p> <p>REM7V = 7 watt emergency module with remote test / indicator light, use with DLV only ⁽¹⁾⁽²⁾</p> <p>REM14V = 14 watt emergency module with remote test / indicator light, use with DLV only ⁽¹⁾⁽²⁾</p> <p>IEM7V = integral 7 watt emergency module with integral test / indicator light, use with DLV only ⁽¹⁾⁽²⁾</p> <p>IEM14V = integral 14 watt emergency module with integral test / indicator light, use with DLV only ⁽¹⁾⁽²⁾</p>	<p>HB128APK = L channel hanger bar, 26", pair (replacement)</p> <p>RMB22 = Adjustable wood joist mounting bars, pair, extend to 22" long</p> <p>H347 = 347 to 120V step down transformer, 75VA</p> <p>H347200 = 347 to 120V step down transformer, 200VA</p> <p>WTA=Field installed WaveLinX sensor Kit ⁽¹⁾⁽⁵⁾</p> <p>WTK = Field installed WaveLinX Lite Sensor Kit ⁽⁶⁾</p>
Notes	Notes	Notes	Notes	Notes
		(1) Not available with CP version	(1) Not available with CP version (2) ULus for U.S. only (5) WTA = WaveLinX tile mount sensor kit for daylight dimming, PIR motion sensing, and optional RLTS - Real Time Location Services, use with D010 only (Refer to WaveLinX system specifications) (6) WTK = WaveLinX Lite tile mount sensor kit for daylight dimming, PIR motion sensing, use with D010 only (Refer to WaveLinX Lite system specifications)	(1) Not available with CP version (5) WTA = WaveLinX tile mount sensor kit for daylight dimming, PIR motion sensing, and optional RLTS - Real Time Location Services, use with D010 only (Refer to WaveLinX system specifications) (6) WTK = WaveLinX Lite tile mount sensor kit for daylight dimming, PIR motion sensing, use with D010 only (Refer to WaveLinX Lite system specifications)

LED Module	Lumens	CRI/CCT
<p>HM4 = 4" LED module</p>	<p>12=1000, 1500 and 2000 lumens (nominal), use with HC410*, HC415*, HC420* housings</p> <p>34=3000 and 4000 lumens (nominal), use with HC430*, HC440* housings</p>	<p>827 = 80 CRI (min), 2700K CCT</p> <p>830 = 80 CRI (min), 3000K CCT</p> <p>835 = 80 CRI (min), 3500K CCT</p> <p>840 = 80 CRI (min), 4000K CCT</p> <p>927 = 90 CRI (min), 2700K CCT</p> <p>930 = 90 CRI (min), 3000K CCT</p> <p>935 = 90 CRI (min), 3500K CCT</p> <p>940 = 90 CRI (min), 4000K CCT</p>
Notes	Notes	Notes

Reflector	Distribution ⁽³⁾	Finish	Flange	Accessories
<p>41 = 4" conical reflector</p>	<p>ND = narrow 50° beam angle 0.84 SC (nominal)</p> <p>MD = medium 60° beam angle 1.00 SC (nominal)</p> <p>WD = wide 75° beam angle 1.24 SC (nominal)</p> <p>RWW = rotatable wall wash with linear spread lens</p>	<p>C = Specular clear</p> <p>H = Semi-specular clear</p> <p>W = White</p>	<p>Blank = Polished flange standard with C & H reflectors</p> <p>Blank = White flange standard with W reflector</p> <p>WF = White flange option available with C & H reflectors</p>	<p>41RWWPK = rotatable wall wash insert for 4" reflector –replacement part kit</p>
Notes	Notes	Notes	Notes	Notes
	(3) Values are nominal for white reflector, others may vary.			

Order Information

Baffle	Distribution ⁽³⁾	Finish	Flange	Accessories
41 = 4" baffle reflector	WD = wide 75° beam angle 1.24 SC (nominal) RWW = rotatable wall wash with linear spread lens	BB = Black baffle WB = White baffle	Blank = White flange standard with BB, & WB BF = Black flange option available with BB	41RWWPK = rotatable wall wash insert for 4" reflector –replacement part kit
Notes	Notes	Notes	Notes	Notes
(3) Values are nominal for white reflector, others may vary.				

IEM Reflector	Distribution ⁽³⁾	Finish	Flange	Integral Emergency
41 = 4" conical reflector for integral emergency only	ND = narrow 50° beam angle 0.84 SC (nominal) MD = medium 60° beam angle 1.00 SC (nominal) WD = wide 75° beam angle 1.24 SC (nominal)	C = Specular clear H = Semi-specular clear W = White	Blank = Polished flange standard with C & H reflectors Blank = White flange standard with W reflector WF = White flange option available with C & H reflectors	IEM = Reflector for integral emergency only
Notes	Notes	Notes	Notes	Notes
(3) Values are nominal for white reflector, others may vary.				

IEM Baffle	Distribution ⁽³⁾	Finish	Flange	Integral Emergency
41 = 4" baffle reflector for integral emergency only	WD = wide 75° beam angle 1.24 SC (nominal)	BB = Black baffle WB = White baffle	Blank = White flange standard with BB, & WB BF = Black flange option with BB	IEM = Reflector for integral emergency only
Notes	Notes	Notes	Notes	Notes
(3) Values are nominal for white reflector, others may vary.				

Reflector	Distribution ⁽³⁾	Finish	Flange
41PS = 4" non-conductive polymer 'dead front' conical reflector ⁴	MD = medium 60° beam angle 1.00 SC (nominal)	W = White	Blank = White flange standard with W reflector
Notes	Notes	Notes	Notes
(3) Values are nominal for white reflector, others may vary.			

Product Specifications

Housing Frame

- Boat shaped galvanized steel plaster frame with adjustable plaster lip
- Accommodates 1/2" to 1-1/2" thick ceilings
- Installs in new construction or from below the finished ceiling (non-accessible) for remodeling
- Provided with two remodel clips to secure the frame to the ceiling

Universal Mounting Bracket

- Adjusts 2" vertically from above and below the ceiling
- Use with the included mounting bars or with 1/2" Electric Metallic Tube (EMT)
- Removable to facilitate remodeling installation from below the finished ceiling

Mounting Bars

- Captive pre-installed No Fuss™ mounting bars lock to T-grid with screwdriver or pliers
- Centering detents allow for consistent positioning of fixtures

LED Module

- Proximity phosphors over chip on board LEDs provide a uniform source with high efficiency and no pixilation
- Available in 80 or 90 color rendering index (CRI)
- Color accuracy within 3 SDCM provides color consistency and uniformity
- 90 CRI option: R9>50 (refer to chromaticity information for details)
- Available in 2700K, 3000K, 3500K and 4000K correlated color temperature (CCT)
- Lumen options include 1,000, 1,500, 2,000, 3,000 and 4,000 lumens (nominal)
- Passive thermal management achieves 60,000 hours at 70% lumen maintenance (L70) in insulated ceilings (IC) and non-IC applications
- Integral diffuse lens provides visual shielding
- Integral connector allows quick connection to housing flex

Reflector

- Self-flanged aluminum reflectors available in narrow, medium or wide distribution patterns
- Medium distribution polymer non-conductive matte white reflector may be used to meet local codes for 'dead front' applications
- Wall wash reflector features a rotatable linear spread lens for alignment of vertical illumination
- Reflectors attach to LED module with three speed clamps
- Available in multiple painted or plated finishes

Reflector/Module Retention

- Reflector/module assembly is securely retained in the housing with two torsion springs

Driver

- Field-replaceable constant current driver provides low noise operation
- Universal 120-277VAC 50/60Hz input standard
- 347VAC 50/60Hz input option (Canada only)
- Continuous, 1% to 100% dimming with 0-10V analog control
- Optional low-voltage DC driver for use with Distributed Low Voltage Power (DLVP) system
- Distributed Low Voltage Power (DLVP) system combines power, lighting and controls with ease of installation (refer to DLVP Design Guide at www.cooperlighting.com for details)

Emergency Option

- Provides 90 minutes of standby lighting, meeting most life safety codes for egress lighting
- Available with integral or remote charge indicator and test switch
- Available Self-Test (self-diagnostic) with remote charge indicator and test switch

Connected Lighting System Options

Two WaveLinx connected systems to choose. Summary information provided below, refer to WaveLinx system specifications and application guides for details.

WaveLinx Wireless System Tilemount Sensor Kit

- WaveLinx Wireless WTA tile mount sensor kit offers daylight dimming, PIR motion sensing, scene and zone configuration, automatic commissioning; and optional RLTS - Real Time Location Services available.

WaveLinx Lite System Tilemount Sensor Kit

- WaveLinx Lite WTK tile mount sensor kit offers daylight dimming and PIR motion sensing, scene and grouping configuration.

WaveLinx Tilemount Kits Application

- The WTA and WTK tilemount kits include a control module mounted on the luminaire junction box via 1/2" knock-out, and a tilemount sensor on 54-inch whip; for ceiling installation by direct-mount spring clips or via mounting bracket in octagon ceiling boxes.
- The WTA and WTK tilemount kits may be ordered as factory installed on the luminaire, or ordered separately as a field installed accessory kit.

Junction Box

- Galvanized steel junction box
- 20 in³ internal volume excluding voltage barrier
- 25 in³ internal total volume
- Voltage barrier for 0-10V dimming wires (occupies one 1/2" pry-out space)
- Listed for eight #12 AWG (four in, four out) 90°C conductors and feed-thru branch wiring
- Three 1/2" and two 3/4" trade size pry-outs available
- Three 4-port push wire nuts for mains voltage with 1-port for fixture connection

Compliance

- cULus damp and wet location listed in protected ceilings
- IP20 - Above finished ceiling; IP64 - Below finished ceiling
- Non-Insulated ceiling (Non-IC) rated for 2,000, 3,000 and 4,000 lumen models (insulation must be kept 3" from top and sides)
- Insulated ceiling (IC) rated for 1,000 and 1,500 lumen models and suitable for direct contact with air permeable insulation* (IC models are also suitable for Non-IC installations)
- Airtight per ASTM-E283-04
- Suitable for use in clothes closets when installed in accordance with the NEC 410.16 spacing requirements
- EMI/RFI emissions FCC CFR Title 47 Part 15 Class A at 120/277V
- Contains no mercury or lead and RoHS compliant
- Photometric testing completed in accordance of IES LM-79-08
- Lumen maintenance projection in accordance of IES LM-80-08 and TM-21-11
- 1,000 and 1,500 lumen, 90 CRI, ICAT models may be used to comply with State of California Title 24 residential code, per JA8 certification standards
- May be used to comply with State of California Title 24 non-residential code as a dimmable LED luminaire
- ENERGY STAR® certified, reference certified light fixtures database
- *Not for use in direct contact with spray foam insulation, consult NEMA LSD57-2013

Warranty

- Five year limited warranty, consult website for details. www.cooperlighting.com/legal

Photometric Data

 View IES files

NARROW DISTRIBUTION - SPECULAR CLEAR FINISH, 2000 LUMEN MODEL, 80 CRI, 3500K

NARROW (50° BEAM*)	
Test Number	P255618
Housing	HC420D010
Module	HM412835
Reflector	41NDC
Lumens	1667 Lm
Efficacy	83.4 Lm/W
SC	0.84
UGR	12.2

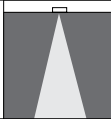
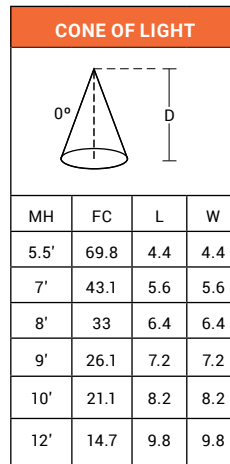
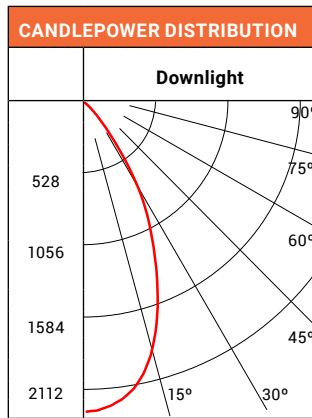
CANDELA TABLE	
Degrees Vertical	Candela
0	2112
5	2079
15	1784
25	1157
35	534
45	116
55	13
65	0
75	0
85	0
90	0

ZONAL LUMEN SUMMARY		
Zone	Lumens	% Fixture
0-30	1219	73.1
0-40	1553	93.1
0-60	1666	99.9
0-90	1667	100
90-180	0	0
0-180	1667	100

LUMINANCE	
Average Candela Degrees	Average 0° Luminance
45	15974
55	2141
65	0
75	0
85	0

MEDIUM DISTRIBUTION - SPECULAR CLEAR FINISH, 2000 LUMEN MODEL, 80 CRI, 3500K

MEDIUM (60° BEAM*)	
Test Number	P255818
Housing	HC420D010
Module	HM412835
Reflector	41MDC
Lumens	1793 Lm
Efficacy	89.7 Lm/W
SC	1.0
UGR	13.6

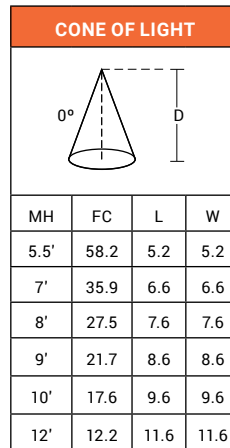
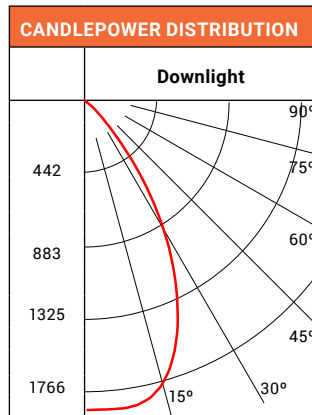
CANDELA TABLE	
Degrees Vertical	Candela
0	1761
5	1764
15	1686
25	1257
35	655
45	164
55	28
65	8
75	2
85	0
90	0

ZONAL LUMEN SUMMARY		
Zone	Lumens	% Fixture
0-30	1209	67.4
0-40	1615	90.1
0-60	1784	99.5
0-90	1793	100
90-180	0	0
0-180	1793	100

LUMINANCE	
Average Candela Degrees	Average 0° Luminance
45	22576
55	4707
65	1753
75	941
85	0

Note: Refer to IES files for more product data.

WIDE DISTRIBUTION - SPECULAR CLEAR FINISH, 2000 LUMEN MODEL, 80 CRI, 3500K

WIDE (75° BEAM*)	
Test Number	P256018
Housing	HC420D010
Module	HM412835
Reflector	41WDC
Lumens	1889 Lm
Efficacy	94.4 Lm/W
SC	1.24
UGR	15.7

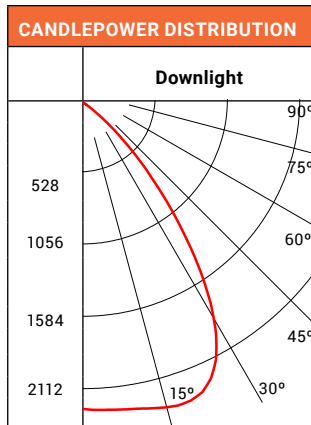

CONE OF LIGHT			
MH	FC	L	W
5.5'	41.6	6.6	6.6
7'	25.7	8.6	8.6
8'	19.7	9.8	9.8
9'	15.5	11	11
10'	12.6	12.2	12.2
12'	8.7	14.6	14.6

CANDELA TABLE	
Degrees Vertical	Candela
0	1257
5	1265
15	1295
25	1247
35	841
45	312
55	50
65	13
75	5
85	0
90	0

ZONAL LUMEN SUMMARY		
Zone	Lumens	% Fixture
0-30	1054	55.8
0-40	1571	83.2
0-60	1871	99.1
0-90	1889	100
90-180	0	0
0-180	1889	100

LUMINANCE	
Average Candela Degrees	Average 0° Luminance
45	43057
55	8564
65	2906
75	1883
85	0

*Value are nominal for specular clear reflectors, other may vary.
 SC = Spacing Criteria
 UGR = Unified Glare Rating

Photometric Multipliers (Nominal Lumen Values)

1000 Lumen	1500 Lumen	2000 Lumen	3000 LUMEN	4000 LUMEN
0.53	0.72	1.00	1.38	1.87

Multipliers for relative lumen values with other series models.

Color Finish Multipliers

Finish code	C	H	W/WB	BB
Finish	Specular Clear	Semi-Specular	Matte White White Baffle	Black Baffle
Multiplier	1.00	0.95	0.97	0.82

Multipliers for relative lumen values with other color finishes.

CCT Multipliers - 80CRI

2700K	3000K	3500K	4000K
0.91	0.94	1.00	1.01

Multipliers for relative lumen values with other series color temperatures.

CCT Multipliers - 90CRI

2700K	3000K	3500K	4000K
0.75	0.82	0.89	0.89

Multipliers for relative lumen values with other series color temperatures.

WALL WASH DISTRIBUTION - SPECULAR CLEAR FINISH, 2000 LUMEN MODEL, 80 CRI, 3500K

WALL WASH	
Test Number	P256338
Housing	HC420D010
Module	HM412835
Reflector	41RWWC
Lumens	1816 Lm
Efficacy	90.8 Lm/W
SC	1.20

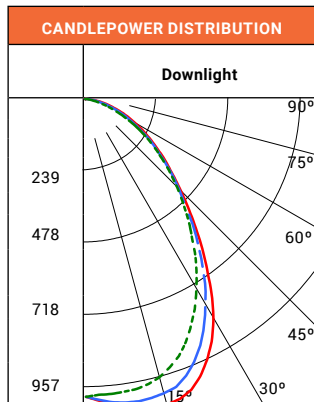

CANDELA TABLE	
Degrees Vertical	Candela
0	901
5	929
15	957
25	871
35	647
45	420
55	267
65	156
75	70
85	8
90	0

ZONAL LUMEN SUMMARY		
Zone	Lumens	% Fixture
0-30	700	38.5
0-40	1078	59.3
0-60	1630	89.8
0-90	1816	100
90-180	0	0
0-180	1816	100

LUMINANCE	
Average Candela Degrees	Average 0° Luminance
45	57956
55	45350
65	35998
75	26547
85	8498

SC = Spacing Criteria, nominal for specular clear reflector, other may vary.

SINGLE UNIT FOOTCANDLES							
2.5' from wall (distance from fixture along wall)							
1	9.4	6.9	3.2	1.1	0.3	0.1	0
2	12.4	9.5	5.2	2.4	0.9	0.3	0.1
3	13.7	11.1	5.9	2.5	1.1	0.4	0.2
4	10.7	9.4	6.1	3	1.2	0.5	0.2
5	7.7	7	5.4	3.1	1.5	0.6	0.2
6	5.5	5.2	4.3	3	1.6	0.8	0.3
7	4	3.9	3.4	2.6	1.6	0.9	0.4
8	3	2.9	2.6	2.1	1.5	0.9	0.5
9	2.3	2.2	2.1	1.8	1.4	1	0.6
10	1.8	1.8	1.6	1.4	1.2	0.9	0.6

MULTIPLE UNIT FOOTCANDLES						
2.5' from wall (Distance from fixture along wall)				2.5' from wall (Distance from fixture along wall)		
3				4		
1	10.5	9.8	10.5	10.5	9.8	10.5
2	14.8	14.5	14.8	14.8	14.5	14.8
3	16.2	17	16.2	16.2	17	16.2
4	13.7	15.8	13.7	13.7	15.8	13.7
5	10.8	12.6	10.8	10.8	12.6	10.8
6	8.5	9.6	8.5	8.5	9.6	8.5
7	6.6	7.3	6.6	6.6	7.3	6.6
8	5.2	5.6	5.2	5.2	5.6	5.2
9	4.1	4.4	4.1	4.1	4.4	4.1
10	3.2	3.4	3.2	3.2	3.4	3.2

Photometric Multipliers (Nominal Lumen Values)

1000 Lumen	1500 Lumen	2000 Lumen	3000 Lumen	4000 Lumen
0.53	0.72	1.00	1.38	1.87

Multipliers for relative lumen values with other series models.

Color Finish Multipliers

Finish code	C	H	W/WB	BB
Finish	Specular Clear	Semi-Specular	Matte White White Baffle	Black Baffle
Multiplier	1.00	0.95	0.97	0.82

Multipliers for relative lumen values with other color finishes.

CCT Multipliers – 80CRI

2700K	3000K	3500K	4000K
0.91	0.94	1.00	1.01

Multipliers for relative lumen values with other series color temperatures.

CCT Multipliers – 90CRI

2700K	3000K	3500K	4000K
0.75	0.82	0.89	0.89

Multipliers for relative lumen values with other series color temperatures.

Energy & Performance Data

COLOR METRICS - TM-30-15 & CRI/CIE (3500K)

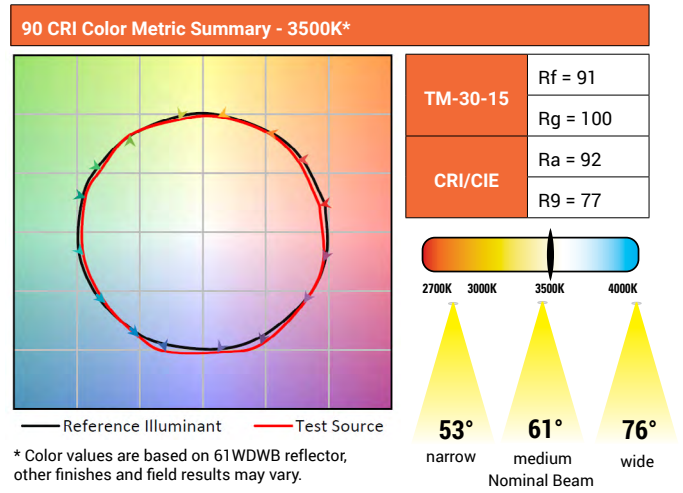
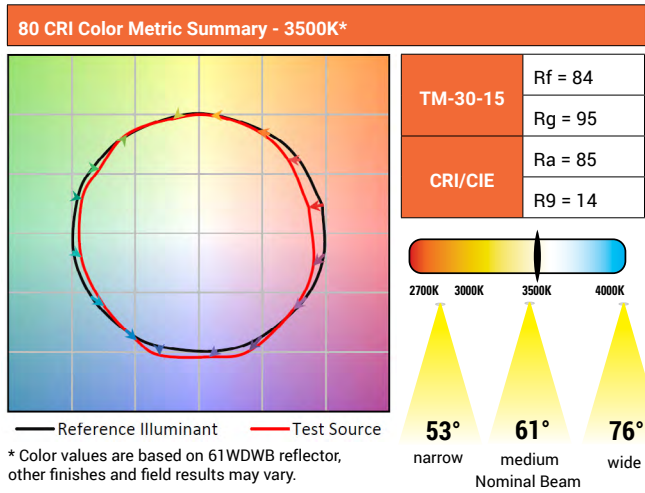

Series	1000 lumen	
Input Voltage 120-277VAC	120V	277V
Input Current (A)	0.085	0.042
Input Power (W)	10.1	10.9
In-rush Current (A)	0.644	1.95
In-rush Duration (ms)	0.125	0.24
THDi (%)	8.6	15.6
PF:	≥ 0.90	
(Nominal input 120-277VAC & 100% of rated output power)		
Minimum starting temperature	-30°C (-22°F)*	
Sound Rating:	Class A standards	

Series	1500 lumen	
Input Voltage 120-277VAC	120V	277V
Input Current (A)	0.119	0.055
Input Power (W)	14.2	14.9
In-rush Current (A)	0.212	0.85
In-rush Duration (ms)	0.28	0.32
THDi (%)	7.8	16.3
PF:	≥ 0.90	
(Nominal input 120-277VAC & 100% of rated output power)		
Minimum starting temperature	-30°C (-22°F)*	
Sound Rating:	Class A standards	

Series	2000 lumen	
Input Voltage 120-277VAC	120V	277V
Input Current (A)	0.176	0.082
Input Power (W)	21.1	21.4
In-rush Current (A)	0.588	0.624
In-rush Duration (ms)	0.3	0.38
THDi (%)	8.8	11.2
PF:	≥ 0.90	
(Nominal input 120-277VAC & 100% of rated output power)		
Minimum starting temperature	-30°C (-22°F)*	
Sound Rating:	Class A standards	

Series	3000 lumen	
Input Voltage 120-277VAC	120V	277V
Input Current (A)	0.228	0.102
Input Power (W)	27.2	27
In-rush Current (A)	0.898	1.7
In-rush Duration (ms)	0.36	0.38
THDi (%)	9.7	9.3
PF:	≥ 0.90	
(Nominal input 120-277VAC & 100% of rated output power)		
Minimum starting temperature	-30°C (-22°F)*	
Sound Rating:	Class A standards	

Series	4000 lumen	
Input Voltage 120-277VAC	120V	277V
Input Current (A)	0.345	0.15
Input Power (W)	41.3	40.7
In-rush Current (A)	1.05	2.23
In-rush Duration (ms)	0.32	0.34
THDi (%)	10.06	14.01
PF:	≥ 0.90	
(Nominal input 120-277VAC & 100% of rated output power)		
Minimum starting temperature	-30°C (-22°F)*	
Sound Rating:	Class A standards	

Notes:

* Emergency Battery packs are rated for a minimum starting temperature of 0°C.

Connected Systems

WaveLinx Lite - WTK Tilemount Sensor



- Intuitive Android™ or Apple® iOS® app for basic system code compliant set up and configuration via Bluetooth
- Up to 28 unique areas per project site (WaveLinx Lite Bluetooth network)
- Up to 50 devices for an area, any one of 16 control zones, up to 6 occupancy sets, and custom lighting scenes
- Automatic occupancy or vacancy, sensor sensitivity, daylight dimming, etc. configurable through the app
- Refer to the WaveLinx system specifications for details



WaveLinx Lite WTK Tilemount Wiring Diagram

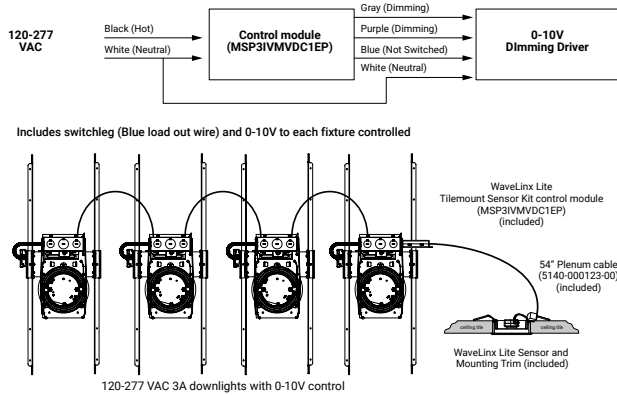

WaveLinx Lite Bluetooth Enabled System

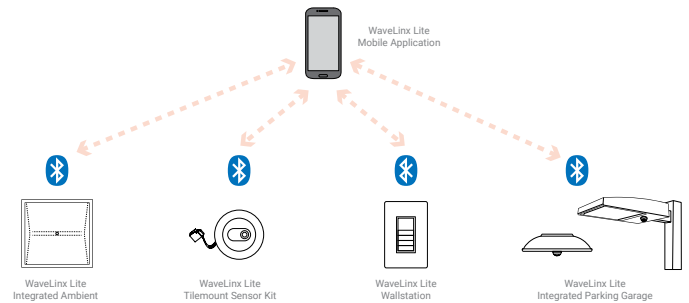

WaveLinx Wireless – WTA Tilemount Sensor



- WaveLinx Wireless functionality configures zones and customizes settings from one secure mobile app
- Automatic code commissioning that meets the strictest codes
- Fixtures and sensors integrate with Wireless Area Controller, Wall Stations, and Control Devices
- Stand-Alone Offices or Entire Building Network Installations



WaveLinx mobile app settings

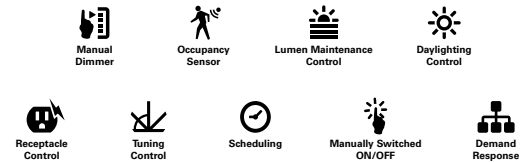

WaveLinx Lite WTA Tilemount Wiring Diagram

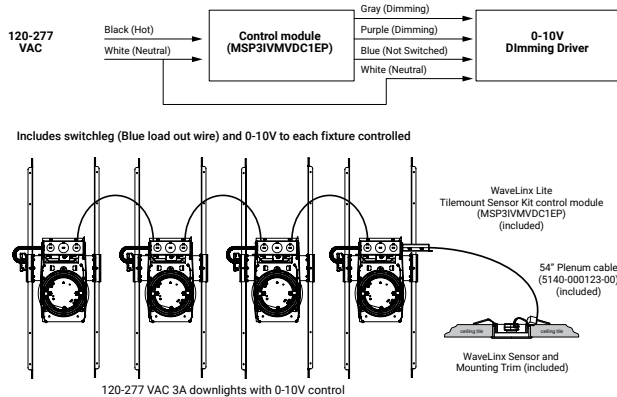

WaveLinx Wireless Trellix Building Management Integration

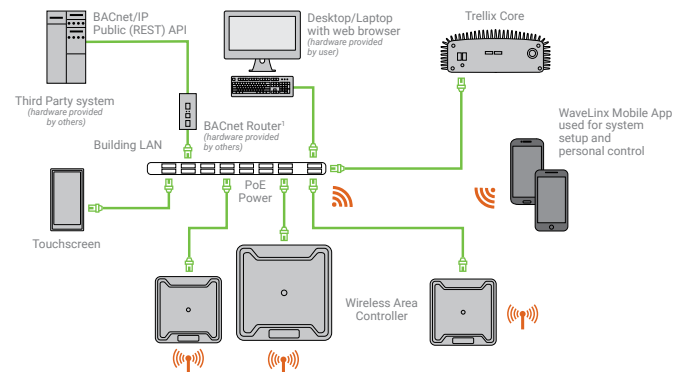

Dimensional and Mounting Details

NEW CONSTRUCTIONS - HIGH LUMEN 3000 AND 4000 LUMENS

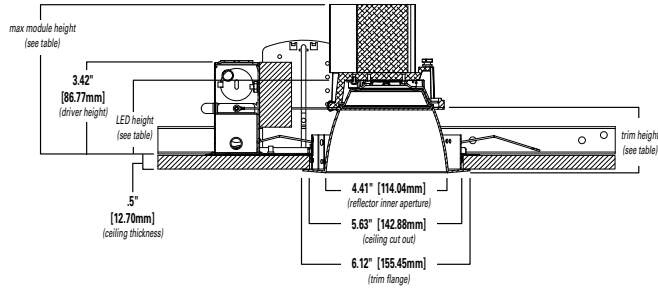

NEW CONSTRUCTIONS - LOW LUMEN 1000, 1500, AND 2000 LUMENS

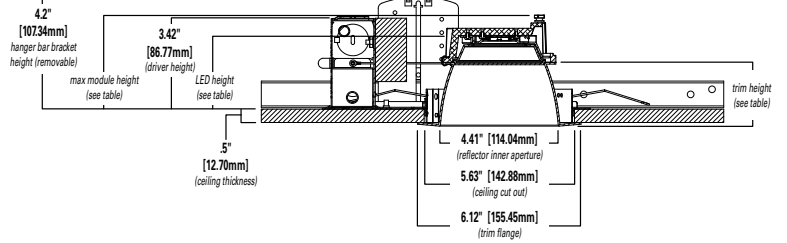

High Lumen (3000 & 4000 Lumens)

Distribution	Max. Module Height	Trim Height	LED Height
Narrow	5.6"	2.5"	2.9"
Medium	5.7"	2.6"	3.0"
Wide	5.5"	2.4"	2.8"
Baffle	5.5"	2.4"	2.8"

Low Lumen (1000, 1500 & 2000 Lumens)*

Max. Module Height	Trim Height	LED Height
3.6"	2.5"	2.7"
3.7"	2.6"	2.8"
3.5"	2.4"	2.6"
3.1"	2.4"	2.6"

*Max. height w/hanger bar bracket 4.2"