

Project		Catalog #		Type	
Prepared by		Notes		Date	

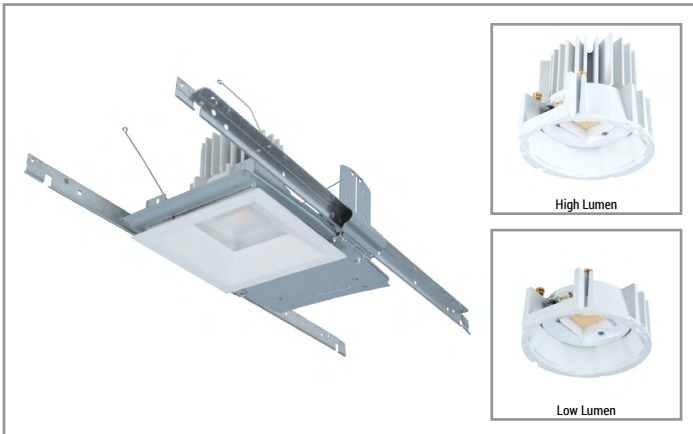

# HALO Commercial

## PRS6 | SM6 | 61S/64S

6-inch LED square aperture  
new construction/remodel  
downlight and wall wash

### Typical Applications

Office • Healthcare • Hospitality • Institutional • Mixed-Use/Retail

### Interactive Menu

- Order Information [page 2](#)
- Product Specifications [page 4](#)
- Photometric Data [page 5](#)
- Energy & Performance Data [page 10](#)
- Connected Systems [page 11](#)
- Product Warranty

### Product Certification



### Product Features



### Top Product Features

- New construction/remodel series; True square aperture design with refined corner detail
- Selectable lumens: 1,000/1,500/2,000 (low) or 3,000/4,000 (high)
- Narrow, Medium and Wide distributions; Wall wash with linear spread lens
- Selectable color temperatures: 3000K, 3500K and 4000K CCT; 80 CRI
- Universal voltage 120V-277V; Standard 0-10V driver dims to 1%

### Dimensional and Mounting Details

6", LOW LUMEN MODULE (1000 - 1500 - 2000 LUMEN)

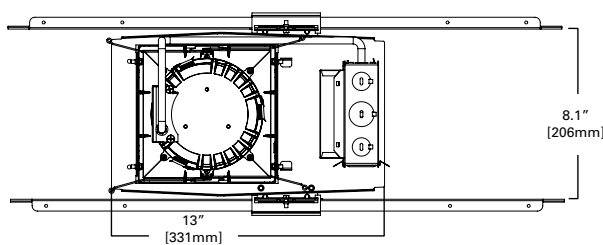

6", HIGH LUMEN MODULE (2000 - 3000 - 4000 LUMEN)

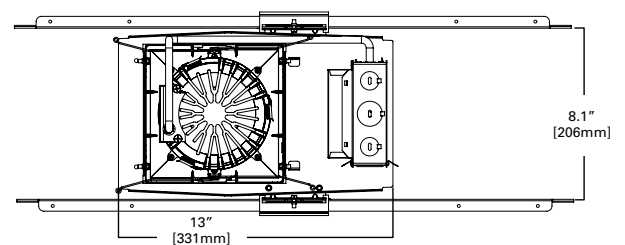

[additional product diagrams](#)

## Order Information

**SAMPLE NUMBER: PRS6FS24D010REM7 - SM6248FS - 61SMDH**

A complete luminaire consists of a mounting frame, LED module, and reflector (ordered separately)

### Ordering Information, 120-277VAC, 0-10V analog dimming

Housing Frame	Lumens	Input / Control	Options
<b>PRS6</b> = 6" square new construction and remodeler housing	<b>Field Selectable</b> <b>FS12</b> = field selectable 1000, 1500 and 2000 lumens (nominal), use with SM6128FS LED module <b>FS24</b> = field selectable 2000, 3000 and 4000 lumens (nominal), use with SM6248FS LED module  <b>Fixed, Factory Set</b> <b>10</b> = 1000 lumens (nominal), use with SM6128FS LED module (Type IC rated) <b>15</b> = 1500 lumens (nominal), use with SM6128FS LED module (Type IC rated) <b>30</b> = 3000 lumens (nominal), use with SM6248FS LED module	<b>D010</b> =120-277VAC, 50/60Hz, 0-10V analog 1% dimming	<b>REM7</b> =7 watt emergency module with remote test / indicator light, use with D010 only <b>REM14</b> =14 watt emergency module with remote test / indicator light, use with D010 only <b>BOD7ST</b> = 7.5 watt Bodine self-test diagnostic emergency module with remote test / indicator light, use with D010 only <b>WTA</b> =Factory installed WaveLinx sensor Kit <sup>(3)</sup> <b>WTK</b> = Factory installed WaveLinx Lite Sensor Kit <sup>(4)</sup>
<b>Notes</b>	<b>Notes</b>	<b>Notes</b>	<b>Notes</b>
			(3) WTA = WaveLinx tilemount sensor kit for daylight dimming, PIR motion sensing, and optional RLTS - Real Time Location Services, use with D010 only (Refer to WaveLinx system specifications) (4) WTK = WaveLinx Lite tilemount sensor kit for daylight dimming, PIR motion sensing, use with D010 only (Refer to WaveLinx Lite system specifications)

### Ordering Information, Distributed Low Voltage Power - for use with DLVP system only

Housing Frame	Lumens	Input / Control	Options
<b>PRS6</b> = 6" square new construction and remodeler housing	<b>Fixed, Factory Set</b> <b>10</b> = 1000 lumens (nominal), use with SM6128FS LED module (Type IC rated) <b>15</b> = 1500 lumens (nominal), use with SM6128FS LED module (Type IC rated) <b>20</b> = 2000 lumens (nominal), use with SM6128FS LED module <b>30</b> = 3000 lumens (nominal), use with SM6248FS LED module <b>40</b> = 4000 lumens (nominal), use with SM6248FS LED module	<b>DLV</b> = Distributed low voltage driver, 1%-100% dimming, DLV for use with DLVP system only. Refer to DLVP low-voltage power module and DLVP specifications for details.	<b>REM7V</b> = 7 watt emergency module with remote test / indicator light, use with DLV only <b>REM14V</b> = 14 watt emergency module with remote test / indicator light, use with DLV only
<b>Notes</b>	<b>Notes</b>	<b>Notes</b>	<b>Notes</b>

### Accessories

Accessories
<b>HB128APK</b> =L channel hanger bar, 26", pair (replacement) <b>RMB22</b> =Adjustable wood joist mounting bars, pair, extend to 22" long <b>H347</b> =347 to 120V step down transformer, 75VA <b>H347200</b> =347 to 120V step down transformer, 200VA <b>WTA</b> =Field installed WaveLinx sensor Kit <sup>(3)</sup> <b>WTK</b> = Field installed WaveLinx Lite Sensor Kit <sup>(4)</sup>
<b>Notes</b>
(3) WTA = WaveLinx tilemount sensor kit for daylight dimming, PIR motion sensing, and optional RLTS - Real Time Location Services, use with D010 only (Refer to WaveLinx system specifications) (4) WTK = WaveLinx Lite tilemount sensor kit for daylight dimming, PIR motion sensing, use with D010 only (Refer to WaveLinx Lite system specifications)

## Order Information

LED Module	Lumens	CRI/CCT
LED Module	Lumens	CRI/CCT
<b>SM6</b> = 6" LED module	12=Field selectable 1000, 1500 and 2000 lumens (nominal), preset for 2000 lumens, use with PRS6FS12*, PRS610*, PRS615*, PRS620* housings 24=Field selectable 2000, 3000 and 4000 lumens (nominal), preset for 4000 lumens, use with PRS6FS24*, PRS620*, PRS630*, PRS640* housings	<b>8FS</b> =80 CRI (minimum), field selectable 3000, 3500 and 4000 CCT, preset for 3500K
Notes	Notes	Notes

Reflector - Deep	Distribution <sup>2</sup>	Finish	Flange	Accessories
Reflector - Deep	Distribution <sup>2</sup>	Finish	Flange	Accessories
<b>61S</b> = 6" square reflector, non-conductive polymer, use with SM6 modules only	<b>ND</b> = narrow, TIR lens included (58° beam angle, 0.8 SC) <b>MD</b> = medium, TIR lens included (68° beam angle, 1.0 SC) <b>WD</b> = wide, TIR lens included (80° beam angle, 1.3 SC) <b>WW</b> = linear spread lens wall wash, insert included	<b>Vacuum Metallized</b> <b>C</b> = Specular clear <b>H</b> = Semi-specular clear (haze) <b>Painted</b> <b>MB</b> = Matte black <b>MW</b> = Matte white	<b>Blank</b> = Vacuum Metallized flange standard on C, H reflectors <b>Blank</b> = White flange on MW reflectors <b>Blank</b> = Black flange on MB reflectors <b>WF</b> = White flange option available with C, H, MB reflectors	<b>TIR6SND</b> = narrow distribution TIR lens for 6" reflectors <sup>(1)</sup> <b>TIR6SMD</b> = medium distribution TIR lens for 6" reflectors <sup>(1)</sup> <b>TIR6SWD</b> = wide distribution TIR lens for 6" reflectors <sup>(1)</sup> <b>S6DWW</b> = wall wash replacement insert for 6" wall wash reflector
Notes	Notes	Notes	Notes	Notes
	(2) Values are nominal for white reflectors, others may vary.			(1) TIR lenses for replacement - field interchangeable

Reflector - Shallow	Distribution <sup>(2)</sup>	Finish	Flange	Accessories
Reflector - Shallow	Distribution <sup>(2)</sup>	Finish	Flange	Accessories
<b>64S</b> = 6" square shallow reflector, non-conductive polymer, use with SM6 modules only	<b>ND</b> = narrow with TIR lens included (59° beam angle, 0.84 SC) <b>MD</b> = medium with TIR lens included (70° beam angle, 0.98 SC) <b>WD</b> = wide with TIR lens included (103° beam angle, 1.35 SC)	<b>Vacuum Metallized</b> <b>C</b> = Specular clear <b>H</b> = Semi-specular clear (haze) <b>Painted</b> <b>MB</b> = Matte black <b>MW</b> = Matte white	<b>Blank</b> = Vacuum Metallized flange standard on C, H reflectors <b>Blank</b> = White flange on MW reflectors <b>Blank</b> = Black flange on MB reflectors <b>WF</b> = White flange option available with C, H, MB reflectors	<b>TIR6SND</b> = narrow distribution TIR lens for 6" reflectors <sup>(1)</sup> <b>TIR6SMD</b> = medium distribution TIR lens for 6" reflectors <sup>(1)</sup> <b>TIR6SWD</b> = wide distribution TIR lens for 6" reflectors <sup>(1)</sup>
Notes	Notes	Notes	Notes	Notes
	(2) Values are nominal for white reflectors, others may vary.			(1) TIR lenses for replacement - field interchangeable

## Product Specifications

### Housing Frame

- Boat shaped galvanized steel plaster frame with adjustable plaster lip
- Accommodates 1/2" to 1-1/2" thick ceilings
- Installs in new construction or from below the finished ceiling (non-accessible) for remodeling
- Provided with four remodel clips to secure the frame when installing from below the ceiling

### Universal Mounting Bracket

- Adjusts 2" vertically from above and below the ceiling
- Use with the included mounting bars or with 1/2" Electric Metallic Tube (EMT)
- Removable to facilitate remodeling installation from below the finished ceiling

### Mounting Bars

- Captive pre-installed No Fuss™ mounting bars lock to T-grid with screwdriver or pliers
- Centering detents allow for consistent positioning of fixtures

### LED Module

- Patented SeleCCTable™ technology allows the color temperature and lumen output to be selected in the field
- Selectable color temperatures in 3000K, 3500K and 4000K correlated color temperature (CCT)
- Selectable lumens: 1,000/1,500/2,000 (low lumens) or 3,000/4,000 (high lumens)
- Discrete (fixed) lumen output is also available to meet lighting power density code requirements
- Available in 80 color rendering index (CRI)
- Color accuracy within 3 SDCM provides color consistency and uniformity (refer to chromaticity information for details)
- Integral connector allows for quick connection to the housing flex
- Passive thermal management achieves 50,000 hours at 70% lumen maintenance (L70) in insulated ceilings (IC) and non-IC applications

### Primary Optic

- Precision-molded square Total Internal Reflection (TIR) optics deliver highly efficient and uniform patterns
- Available in narrow, medium and wide distribution patterns and can be interchanged without tools

### Reflector

- Self-flanged downlight reflectors are available in shallow and deep regression
- Reflectors are of non-conductive polymer construction and may be used to meet local code requirements for 'dead front'
- Wall wash reflector features a linear spread lens for alignment of vertical illumination
- Reflectors attach to LED module with three speed clamps
- Available in multiple painted or plated finishes

### Reflector/Module Retention

- Reflector/module assembly is securely retained in the housing with two torsion springs

### Driver

- Field-replaceable constant current driver provides low noise operation
- Universal 120-277VAC 50/60Hz input standard
- Continuous, 1% to 100% dimming with 0-10V analog control
- Optional low-voltage DC driver for use with Distributed Low Voltage Power (DLVP) system
- Distributed Low Voltage Power (DLVP) system combines power, lighting and controls with ease of installation (refer to DLVP Design Guide at [www.cooperlighting.com](http://www.cooperlighting.com) for details)

### Emergency Option

- Provides 90 minutes of standby lighting, meeting most life safety codes for egress lighting
- Available with remote charge indicator and test switch
- Available Self-Test (self-diagnostic) with remote charge indicator and test switch

### Connected Lighting System Options

Two WaveLinX connected systems to choose. Summary information provided below, refer to WaveLinX system specifications and application guides for details.

#### WaveLinX Wireless System Tilemount Sensor Kit

- WaveLinX Wireless WTA tilemount sensor kit offers daylight dimming, PIR motion sensing, scene and zone configuration, automatic commissioning; and optional RLTS - Real Time Location Services available.

#### WaveLinX Lite System Tilemount Sensor Kit

- WaveLinX Lite WTK tilemount sensor kit offers daylight dimming and PIR motion sensing, scene and grouping configuration.

#### WaveLinX Tilemount Kits Application

- The WTA and WTK tilemount kits include a control module mounted on the luminaire junction box via 1/2" knock-out, and a tilemount sensor on 54-inch whip; for ceiling installation by direct-mount spring clips or via mounting bracket in octagon ceiling boxes.
- The WTA and WTK tilemount kits may be ordered as factory installed on the luminaire, or ordered separately as a field installed accessory kit.

### Junction Box

- Galvanized steel junction box
- 20 in<sup>3</sup> internal volume excluding voltage barrier
- 25 in<sup>3</sup> internal total volume
- Voltage barrier for 0-10V dimming wires (occupies one 1/2" pry-out space)
- Listed for eight #12 AWG (four in, four out) 90°C conductors and feed-thru branch wiring
- Three 1/2" and two 3/4" trade size pry-outs available
- Three 4-port push wire nuts for mains voltage with 1-port for fixture connection

### Compliance

- cULus damp and wet location listed in protected ceilings
  - IP20 - Above finished ceiling; IP64 - Below finished ceiling
  - Non-Insulated ceiling (Non-IC) rated for the field-selectable 1,000, 1,500, 2,000, 3,000 and 4,000 lumen models (insulation must be kept 3" from top and sides)
  - Fixed (non-selectable) factory set 1,000 and 1,500 lumen housing frames are insulated ceiling (IC) rated and suitable for direct contact with air permeable insulation\* (IC models are also suitable for Non-IC installations)
  - Airtight per ASTM-E283-04
  - Suitable for use in clothes closets when installed in accordance with the NEC 410.16 spacing requirements
  - EMI/RFI emissions FCC CFR Title 47 Part 15 Class A at 120/277V
  - Contains no mercury or lead and RoHS compliant
  - Photometric testing completed in accordance of IES LM-79-08
  - Lumen maintenance projection in accordance of IES LM-80-08 and TM-21-11
  - May be used to comply with State of California Title 24 non-residential code as a dimmable LED luminaire
  - ENERGY STAR® certified, reference certified light fixtures database
- \*Not for use in direct contact with spray foam insulation, consult NEMA LSD57-2013

### Warranty

- Five year limited warranty, consult website for details. [www.cooperlighting.com/legal](http://www.cooperlighting.com/legal)

## Photometric Data

 [View IES files](#)

### DEEP REFLECTORS 61S SERIES

#### NARROW DISTRIBUTION - SPECULAR CLEAR FINISH, 2000 LUMEN MODEL, 80 CRI, 3500K

NARROW (52° BEAM*)	
Test Number	P238270
Housing	PRS6FS12D010
Module	SM6128FS
Reflector	61SNDC
Lumens	2388 Lm
Efficacy	119.4 Lm/W
SC	0.79
UGR	12.9

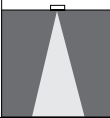
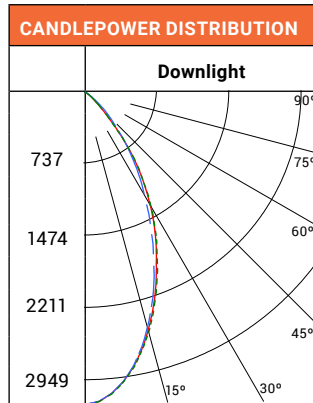
CONE OF LIGHT			
			
MH	FC	L	W
5.5'	97.5	4.2	4.2
7'	60.2	5.4	5.4
8'	46.1	6.2	6.2
9'	36.4	7	7
10'	29.5	7.8	7.8
12'	20.5	9.4	9.4

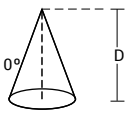
CANDELA TABLE	
Degrees Vertical	Candela
0	2949
5	2855
15	2309
25	1577
35	859
45	206
55	43
65	0
75	0
85	0
90	0

ZONAL LUMEN SUMMARY		
Zone	Lumens	% Fixture
0-30	1608	67.3
0-40	2123	88.9
0-60	2383	99.8
0-90	2388	100
90-180	0	0
0-180	2388	100

LUMINANCE	
Average Candela Degrees	Average 0° Luminance
45	12549
55	3258
65	0
75	0
85	0

#### MEDIUM DISTRIBUTION - SPECULAR CLEAR FINISH, 2000 LUMEN MODEL, 80 CRI, 3500K

MEDIUM (62° BEAM*)	
Test Number	P238285
Housing	PRS6FS12D010
Module	SM6128FS
Reflector	61SMDC
Lumens	2316 Lm
Efficacy	115.8 Lm/W
SC	0.86
UGR	13.7

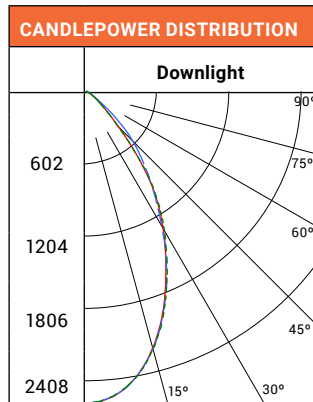
CONE OF LIGHT			
			
MH	FC	L	W
5.5'	79.6	4.6	4.6
7'	49.1	6	6
8'	37.6	6.8	6.8
9'	29.7	7.6	7.8
10'	24.1	8.4	8.6
12'	16.7	10.2	10.4

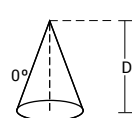
CANDELA TABLE	
Degrees Vertical	Candela
0	2408
5	2364
15	2019
25	1444
35	866
45	230
55	56
65	0
75	0
85	0
90	0

ZONAL LUMEN SUMMARY		
Zone	Lumens	% Fixture
0-30	1452	62.7
0-40	1996	86.2
0-60	2311	99.8
0-90	2316	100
90-180	0	0
0-180	2316	100

LUMINANCE	
Average Candela Degrees	Average 0° Luminance
45	14011
55	4234
65	0
75	0
85	0

Note: Refer to IES files for more product data.

## DEEP REFLECTORS 61S SERIES

### WIDE DISTRIBUTION - SPECULAR CLEAR FINISH, 2000 LUMEN MODEL, 80 CRI, 3500K

WIDE (75° BEAM*)	
Test Number	P253055
Housing	PRS6FS12D010
Module	SM6128FS
Reflector	61SWDC
Lumens	2109 Lm
Efficacy	105.4 Lm/W
SC	1.26
UGR	18.7

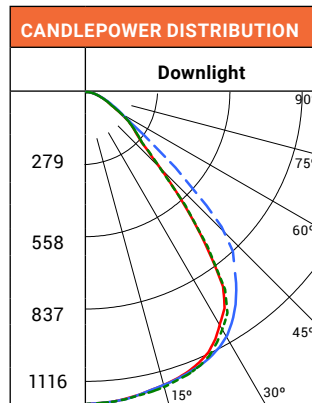

CONE OF LIGHT				
MH	FC	L	W	
5.5'	36.9	6.8	7	
7'	22.8	8.8	8.8	
8'	17.4	10	10.2	
9'	13.8	11.2	11.4	
10'	11.2	12.6	12.6	
12'	7.7	15	15.2	

CANDELA TABLE	
Degrees Vertical	Candela
0	1116
5	1111
15	1083
25	1028
35	849
45	334
55	181
65	81
75	35
85	9
90	0

ZONAL LUMEN SUMMARY		
Zone	Lumens	% Fixture
0-30	890	42.2
0-40	1436	68.1
0-60	1976	93.7
0-90	2109	100
90-180	0	0
0-180	2109	100

LUMINANCE	
Average Candela Degrees	Average 0° Luminance
45	20337
55	13602
65	8232
75	5806
85	4298

\*Values are nominal for specular clear reflectors, others may vary.  
 SC = Spacing Criteria  
 UGR = Unified Glare Rating

#### Photometric Multipliers (Nominal lumen values)

1000 Lumen	1500 Lumen	2000 Lumen	3000 Lumen	4000 Lumen
0.46	0.61	1.00	1.27	1.82

Multipliers for relative lumen values with other series models.

#### CCT Multipliers - 80CRI

3000K	3500K	4000K
0.90	1.00	0.95

Multipliers for relative lumen values with other series color temperatures.

#### Color Finish Multipliers

Finish code	C	H	MB	MW
Finish	Specular Clear	Semi-Specular	Matte Black	Matte White
Narrow Multiplier	1.00	0.99	0.88	1.00
Medium Multiplier	1.00	0.98	0.82	1.00
Wide Multiplier	1.00	0.96	0.70	1.00

Multipliers for relative lumen values with other cone color finishes.

## DEEP REFLECTORS 61S SERIES

### WALL WASH DISTRIBUTION - SPECULAR CLEAR FINISH, 2000 LUMEN MODEL, 80 CRI, 3500K

WALL WASH	
Test Number	P238330
Housing	PRS6FS12D010
Module	SM6128FS
Reflector	61SWWC
Lumens	1602 Lm
Efficacy	80.1 Lm/W
SC	0.98

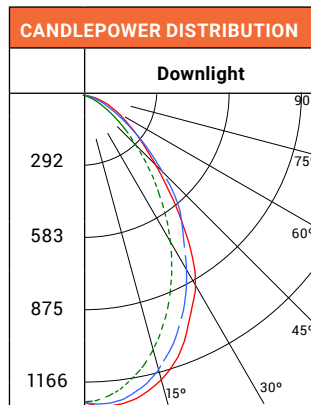

CANDELA TABLE	
Degrees Vertical	Candela
0	1147
5	1166
15	1108
25	936
35	701
45	404
55	232
65	132
75	63
85	13
90	0

ZONAL LUMEN SUMMARY		
Zone	Lumens	% Fixture
0-30	750	46.8
0-40	1100	68.7
0-60	1505	94
0-90	1602	100
90-180	0	0
0-180	1602	100

LUMINANCE	
Average Candela Degrees	Average 0° Luminance
45	24593
55	17445
65	13499
75	10480
85	6422

SC = Spacing Criteria, nominal for specular clear reflector, others may vary.

SINGLE UNIT FOOTCANDLES							
2.5' from wall (distance from fixture along wall)							
1	13.9	9.8	4	1.4	0.5	0.2	0.1
2	21.7	17.4	8.8	3.6	1.5	0.6	0.3
3	22.9	19.2	11.8	5.5	2.4	1.1	0.6
4	18.9	16.3	11.2	6.4	3.1	1.6	0.8
5	12.9	11.6	8.7	5.7	3.3	1.8	1
6	9	8.3	6.6	4.7	3.1	1.9	1.1
7	6.4	6	5	3.8	2.7	1.8	1.2
8	4.6	4.3	3.8	3	2.3	1.7	1.1
9	3.4	3.2	2.9	2.4	1.9	1.4	1.1
10	2.5	2.5	2.2	1.9	1.6	1.2	1

MULTIPLE UNIT FOOTCANDLES						
2.5' from wall (Distance from fixture along wall)				2.5' from wall (Distance from fixture along wall)		
1	15.4	13.1	15.4	14.4	8	14.4
2	25.2	26.3	25.2	23.1	17.7	23.1
3	28.5	31.3	28.5	25.4	23.6	25.4
4	25.2	27.8	25.2	22	22.4	22
5	18.7	20.5	18.7	16.3	17.4	16.3
6	13.7	15.1	13.7	12.1	13.2	12.1
7	10.2	11	10.2	9.1	10	9.1
8	7.6	8.2	7.6	6.9	7.5	6.9
9	5.8	6.2	5.8	5.3	5.8	5.3
10	4.5	4.7	4.5	4.1	4.5	4.1

#### Photometric Multipliers (Nominal lumen values)

1000 Lumen	1500 Lumen	2000 Lumen	3000 Lumen	4000 Lumen
0.46	0.61	1.00	1.27	1.82

Multipliers for relative lumen values with other series models.

#### CCT Multipliers – 80CRI

3000K	3500K	4000K
0.90	1.00	0.95

Multipliers for relative lumen values with other series color temperatures.

#### Color Finish Multipliers

Finish code	C	H	MB	MW
Finish	Specular Clear	Semi-Specular	Matte Black	Matte White
Wall Wash Multiplier	1.00	0.98	0.91	1.00

Multipliers for relative lumen values with other cone color finishes.

## SHALLOW REFLECTORS 64S SERIES

### NARROW DISTRIBUTION - SPECULAR CLEAR FINISH, 2000 LUMEN MODEL, 80 CRI, 3500K

NARROW (59° BEAM*)	
Test Number	P238090
Housing	PRS6FS12D010
Module	SM6128FS
Reflector	64SNDC
Lumens	2470 Lm
Efficacy	123.5 Lm/W
SC	0.82
UGR	18.1

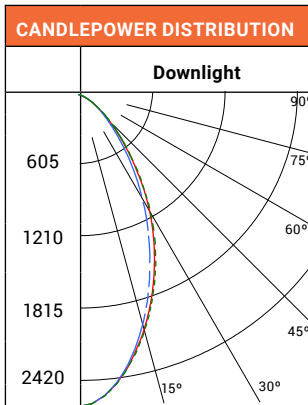

CONE OF LIGHT				
MH	FC	L	W	
5.5'	80	4.4	4.4	
7'	49.4	5.6	5.8	
8'	37.8	6.4	6.6	
9'	29.9	7.4	7.4	
10'	24.2	8.2	8.2	
12'	16.8	9.8	10	

CANDELA TABLE	
Degrees Vertical	Candela
0	2420
5	2342
15	1921
25	1392
35	868
45	436
55	193
65	70
75	13
85	0
90	0

ZONAL LUMEN SUMMARY		
Zone	Lumens	% Fixture
0-30	1367	55.3
0-40	1878	76
0-60	2375	96.2
0-90	2470	100
90-180	0	0
0-180	2470	100

LUMINANCE	
Average Candela Degrees	Average 0° Luminance
45	26566
55	14503
65	7081
75	2163
85	0

### MEDIUM DISTRIBUTION - SPECULAR CLEAR FINISH, 2000 LUMEN MODEL, 80 CRI, 3500K

MEDIUM (70° BEAM*)	
Test Number	P238105
Housing	PRS6FS12D010
Module	SM6128FS
Reflector	64SMDC
Lumens	2427 Lm
Efficacy	121.3 Lm/W
SC	0.96
UGR	19.8

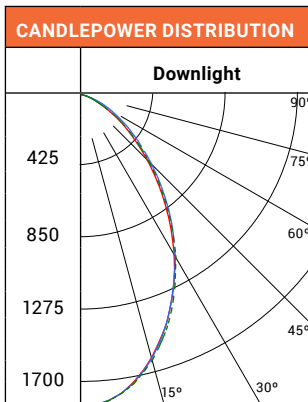

CONE OF LIGHT				
MH	FC	L	W	
5.5'	56.2	5.2	5.2	
7'	34.7	6.6	6.6	
8'	26.6	7.6	7.6	
9'	21	8.4	8.6	
10'	17	9.4	9.6	
12'	11.8	11.4	11.4	

CANDELA TABLE	
Degrees Vertical	Candela
0	1700
5	1672
15	1477
25	1175
35	825
45	502
55	256
65	87
75	17
85	0
90	0

ZONAL LUMEN SUMMARY		
Zone	Lumens	% Fixture
0-30	1113	45.8
0-40	1637	67.4
0-60	2292	94.4
0-90	2427	100
90-180	0	0
0-180	2427	100

LUMINANCE	
Average Candela Degrees	Average 0° Luminance
45	30542
55	19232
65	8853
75	2895
85	0

## SHALLOW REFLECTORS 64S SERIES

### WIDE DISTRIBUTION - SPECULAR CLEAR FINISH, 2000 LUMEN MODEL, 80 CRI, 3500K

WIDE (103° BEAM*)	
Test Number	P252995
Housing	PRS6FS12D010
Module	SM6128FS
Reflector	64SWDC
Lumens	2261 Lm
Efficacy	113.1 Lm/W
SC	1.3
UGR	21.9

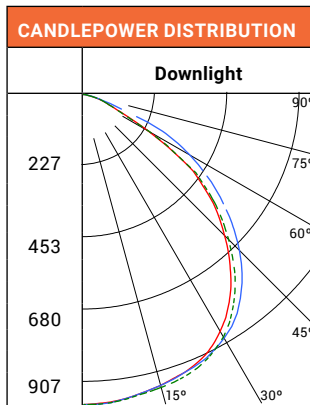

CONE OF LIGHT			
MH	FC	L	W
5.5'	30	7	7.2
7'	18.5	9	9.2
8'	14.2	10.2	10.4
9'	11.2	11.6	11.8
10'	9.1	12.8	13.2
12'	6.3	15.4	15.8

CANDELA TABLE	
Degrees Vertical	Candela
0	907
5	902
15	879
25	841
35	741
45	581
55	390
65	109
75	30
85	2
90	0

ZONAL LUMEN SUMMARY		
Zone	Lumens	% Fixture
0-30	725	32.1
0-40	1202	53.2
0-60	2051	90.7
0-90	2261	100
90-180	0	0
0-180	2261	100

LUMINANCE	
Average Candela Degrees	Average 0° Luminance
45	35383
55	29238
65	11064
75	4957
85	1037

\*Values are nominal for specular clear reflectors, others may vary.  
 SC = Spacing Criteria  
 UGR = Unified Glare Rating

#### Photometric Multipliers (Nominal lumen values)

1000 Lumen	1500 Lumen	2000 Lumen	3000 Lumen	4000 Lumen
0.47	0.62	1.00	1.27	1.83

Multipliers for relative lumen values with other series models.

#### CCT Multipliers - 80CRI

3000K	3500K	4000K
0.90	1.00	0.95

Multipliers for relative lumen values with other series color temperatures.

#### Color Finish Multipliers

Finish code	C	H	MB	MW
Finish	Specular Clear	Semi-Specular	Matte Black	Matte White
Narrow Multiplier	1.00	1.00	0.90	1.04
Medium Multiplier	1.00	0.99	0.95	1.01
Wide Multiplier	1.00	0.99	0.93	1.02

Multipliers for relative lumen values with other cone color finishes.

## Energy & Performance Data

### SM6128FS LED MODULE LOW LUMEN RANGE

Series	1000 lumen		Series	1500 lumen		Series	2000 lumen (Low Lumen)	
Input Voltage 120-277VAC	120V	277V	Input Voltage 120-277VAC	120V	277V	Input Voltage 120-277VAC	120V	277V
Input Current (A)	0.089	0.043	Input Current (A)	0.112	0.052	Input Current (A)	0.178	0.079
Input Power (W)	10.5	11	Input Power (W)	13.4	13.8	Input Power (W)	21.3	21.4
In-rush (A)	8.9	22.2	In-rush (A)	9.9	24.8	In-rush (A)	8	19.1
In-rush Duration (ms)	0.145	0.118	In-rush Duration (ms)	0.198	0.107	In-rush Duration (ms)	0.185	0.133
THD (%)	<15.1	<16.7	THD (%)	<13.3	<15.5	THD (%)	<8.2	<10.6
PF	≥ 0.98	≥ 0.92	PF	≥ 0.98	≥ 0.94	PF	≥ 0.99	≥ 0.97
Minimum starting temperature -40°C (-40°F)*			Minimum starting temperature -40°C (-40°F)*			Minimum starting temperature -40°C (-40°F)*		
Sound Rating: Class A standards			Sound Rating: Class A standards			Sound Rating: Class A standards		

### SM6248FS LED MODULE HIGH LUMEN RANGE

Series	2000 lumen (High Lumen)		Series	3000 lumen		Series	4000 lumen	
Input Voltage 120-277VAC	120V	277V	Input Voltage 120-277VAC	120V	277V	Input Voltage 120-277VAC	120V	277V
Input Current (A)	0.176	0.081	Input Current (A)	0.225	0.101	Input Current (A)	0.332	0.145
Input Power (W)	21	21.2	Input Power (W)	26.9	27	Input Power (W)	39.8	39.4
In-rush (A)	15.3	32.1	In-rush (A)	11.6	27.9	In-rush (A)	12.8	27.5
In-rush Duration (ms)	0.237	0.12	In-rush Duration (ms)	0.187	0.081	In-rush Duration (ms)	0.211	0.107
THD (%)	<11	<13.6	THD (%)	<9.05	<11.8	THD (%)	<5.9	<8.8
PF	≥ 0.99	≥ 0.94	PF	≥ 0.99	≥ 0.96	PF	≥ 0.99	≥ 0.98
Minimum starting temperature -40°C (-40°F)*			Minimum starting temperature -40°C (-40°F)*			Minimum starting temperature -40°C (-40°F)*		
Sound Rating: Class A standards			Sound Rating: Class A standards			Sound Rating: Class A standards		

**Notes:**

\* Emergency Battery packs are rated for a minimum starting temperature of 0°C.

## Connected Systems

### WaveLinx Lite - WTK Tilemount Sensor



- Intuitive Android™ or Apple® iOS® app for basic system code compliant set up and configuration via Bluetooth
- Up to 28 unique areas per project site (WaveLinx Lite Bluetooth network)
- Up to 50 devices for an area, any one of 16 control zones, up to 6 occupancy sets, and custom lighting scenes
- Automatic occupancy or vacancy, sensor sensitivity, daylight dimming, etc. configurable through the app
- Refer to the WaveLinx system specifications for details



#### WaveLinx Lite WTK Tilemount Wiring Diagram

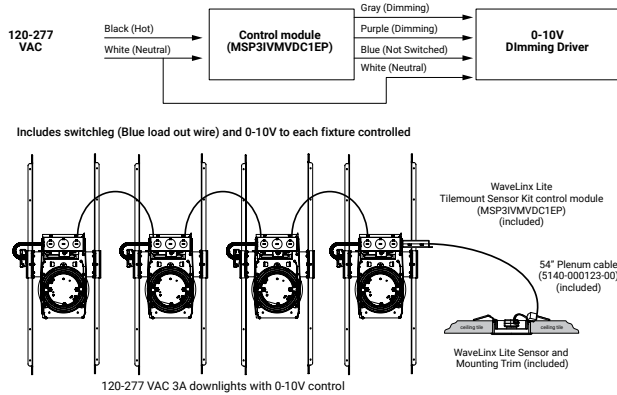

#### WaveLinx Lite Bluetooth Enabled System

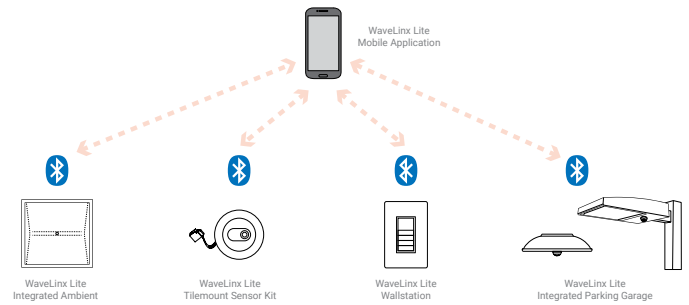

### WaveLinx Wireless – WTA Tilemount Sensor



- WaveLinx Wireless functionality configures zones and customizes settings from one secure mobile app
- Automatic code commissioning that meets the strictest codes
- Fixtures and sensors integrate with Wireless Area Controller, Wall Stations, and Control Devices
- Stand-Alone Offices or Entire Building Network Installations



#### WaveLinx mobile app settings

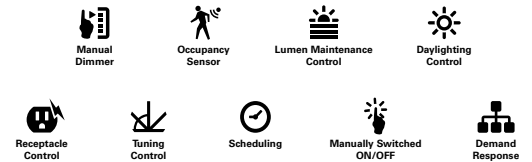

#### WaveLinx Lite WTA Tilemount Wiring Diagram

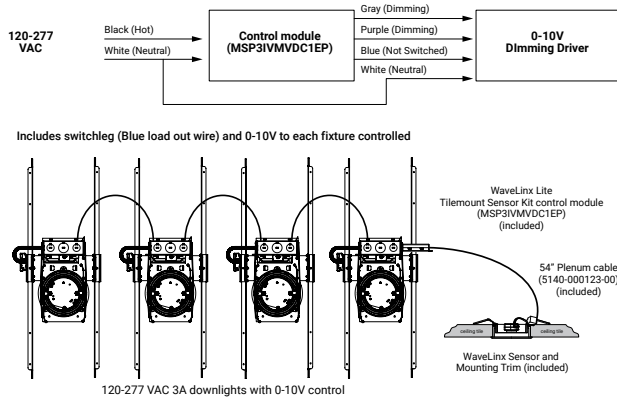

#### WaveLinx Wireless Trellix Building Management Integration

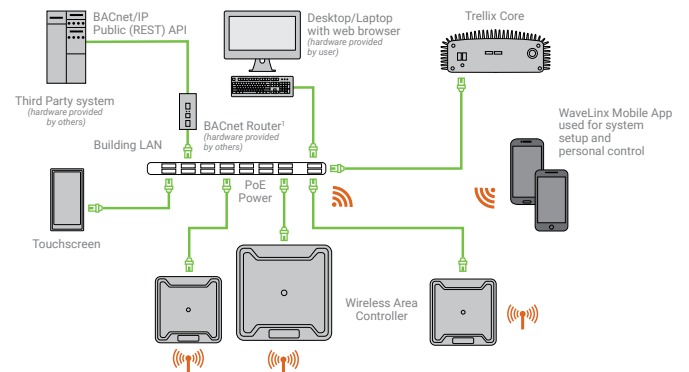

## Dimensional and Mounting Details

6", LOW LUMEN MODULE (1000 - 1500 - 2000 LUMEN)

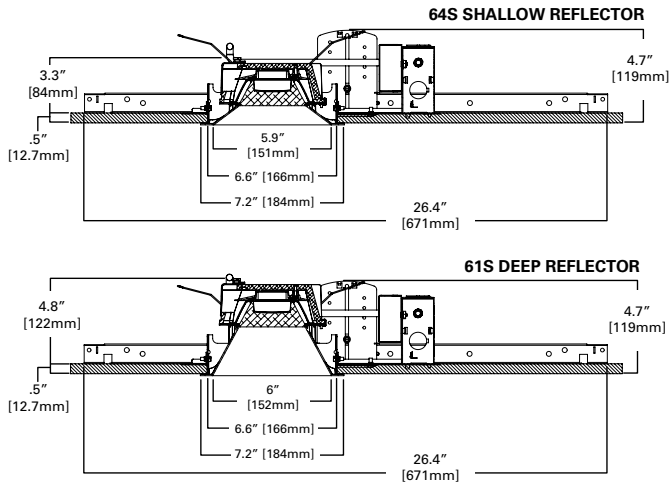

6", HIGH LUMEN MODULE (2000 - 3000 - 4000 LUMEN)

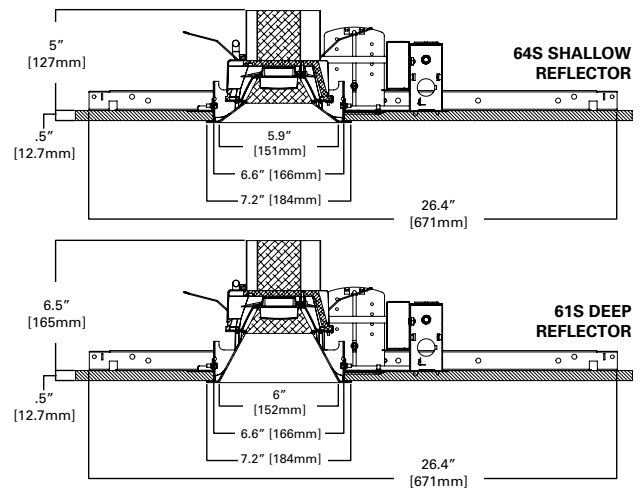

**MAX HEIGHT** (above finished ceiling)

LED MODULE	SM6128FS low lumen module	SM6248FS high lumen module
LUMEN RANGE	1000-1500-2000 Lumens	2000-3000-4000 Lumens
61S Deep Reflector	4.8"	6.5"
64S Shallow Reflector	4.2" (3.3" w/out bar bracket)	5.0"