



HALO[®]

BLD Series
Surface LED Downlight



- 4" aperture low profile surface mounting options
- Two distinct lumen packages & CCT configurations available in both apertures
- 600 lumen package is available in 3000K
- 800 lumen package is available with field SeleCCTable CCT - 2700K|3000K|3500K|4000K|5000K
- 8.2W – 10.3W, Integral 120v 60 Hz constant current driver
- 90 CRI minimum as standard
- L70 @ 50,000 Hrs
- Dimmable to 5% with many 120V leading-edge and trailing-edge phase control dimmers
- Five-year limited warranty
- Installs in many 3-1/2" and 4" ceiling junction boxes as well as pancake boxes*
- Retrofits 4" recessed downlight housings
- cULus certified for Halo housings and many other housings**
- Damp Location Listed for walls
- Wet Location Listed for showers and outdoor protected ceilings
- AIR-TITE™ certified per ASTM-E283
- Plug-in LED connector for easy installation
 - Supply wire adapter connection, for junction box wiring
 - Screwbase adapter for recessed housing retrofit

Ordering Information

SAMPLE NUMBER: BLD406930WH

Models	Lumens	CRI / CCT	Finish	Voltage
BLD4 = 4" Backlit LED Downlight	06 =600 lumen	930 =90 CRI, 3000K	WH = matte white	Blank = 120V

SAMPLE NUMBER: BLD4089SWH

Models	Lumens	CRI / CCT	Finish	Voltage
BLD4 = 4" Backlit LED Downlight	08 =800 lumen	9S =90 CRI, SeleCCTable 2700K, 3000K, 3500K, 4000K & 5000K	WH = matte white	Blank = 120V



* Selectable CCT configurations are not compatible with pancake junction boxes, please see installation instructions for further details.

** Please verify the selected housing meets minimum requirement for internal volume. Refer to specification sheet for further details.

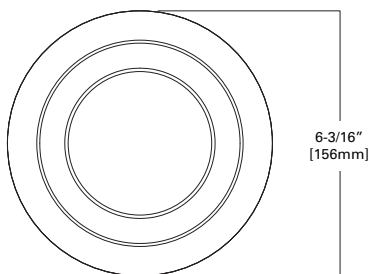

FIXED CCT
BLD406930WH

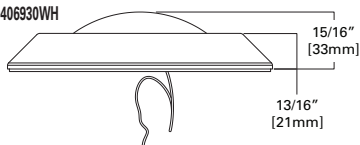

SELECTABLE CCT
BLD4089SWH

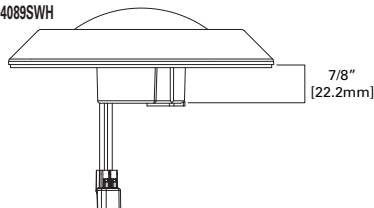

3000K - dedicated	
Lumens	690
Wattage	8.2W
Input current	0.07
Efficacy	84.1 LPW
THD	15.1%
Frequency	60 Hz
T Ambient	-30 - +40°C
Voltage	120V
Sound Rating	Class A
Power Factor	0.99

SeleCCTable 2700K – 5000K	
Lumens	802
Wattage	10.3W
Input current	0.087
Efficacy	77.9 LPW
THD	11.9%
Frequency	60 Hz
T Ambient	-30 - +40°C
Voltage	120V
Sound Rating	Class A
Power Factor	0.99



Refer to ENERGY STAR® Certified Products List. Can be used to comply with California Title 24 High Efficacy requirements. Certified to California Appliance Efficiency Database under JA8.



- 6" aperture low profile surface mounting options
- Two distinct lumen packages & CCT configurations available in both apertures
- 600 lumen package is available in 3000K
- 800 lumen package is available with field SeleCCTable CCT - 2700K|3000K|3500K|4000K|5000K
- 8.2W – 10.3W, Integral 120v 60 Hz constant current driver
- 90 CRI minimum as standard
- L70 @ 50,000 Hrs
- Dimmable to 5% with many 120V leading-edge and trailing-edge phase control dimmers
- Five-year limited warranty
- Installs in many 3-1/2" and 4" ceiling junction boxes as well as pancake boxes*
- Retrofits 6" recessed downlight housings
- cULus certified for Halo housings and many other housings**
- Damp Location Listed for walls
- Wet Location Listed for showers and outdoor protected ceilings
- AIR-TITE™ certified per ASTM-E283
- Plug-in LED connector for easy installation
 - Supply wire adapter connection, for junction box wiring
 - Screwbase adapter for recessed housing retrofit

Ordering Information

SAMPLE NUMBER: BLD606930WH

Models	Lumens	CRI / CCT	Finish	Voltage
BLD6 = 6" Backlit LED Downlight	06=600 lumen	93=90 CRI, 3000K	WH= matte white	Blank= 120V

SAMPLE NUMBER: BLD6089SWH

Models	Lumens	CRI / CCT	Finish	Voltage
BLD6 = 6" Backlit LED Downlight	08=800 lumen	9S=90 CRI, SeleCCTable 2700K, 3000K, 3500K, 4000K & 5000K	WH= matte white	Blank= 120V



* Selectable CCT configurations are not compatible with pancake junction boxes, please see installation instructions for further details.

** Please verify the selected housing meets minimum requirement for internal volume. Refer to specification sheet for further details.

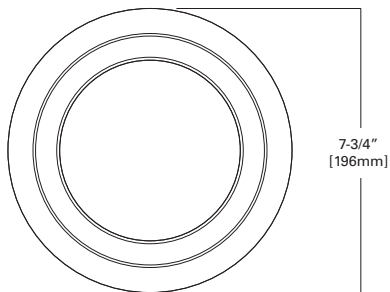

FIXED CCT
BLD606930WH

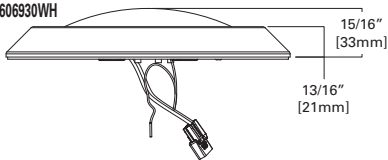

SELECTABLE CCT
BLD6089SWH

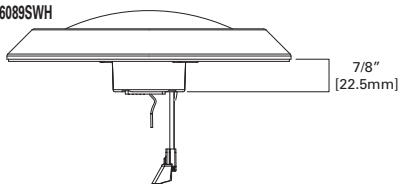

3000K - dedicated	
Lumens	700
Wattage	8.2W
Input current	0.07
Efficacy	85.4 LPW
THD	14.3%
Frequency	60 Hz
T Ambient	-30 - +40°C
Voltage	120V
Sound Rating	Class A
Power Factor	0.99

SeleCCTable 2700K – 5000K	
Lumens	812
Wattage	10.3W
Input current	0.088
Efficacy	78.8 LPW
THD	11.8%
Frequency	60 Hz
T Ambient	-30 - +40°C
Voltage	120V
Sound Rating	Class A
Power Factor	0.99



Refer to ENERGY STAR® Certified Products List. Can be used to comply with California Title 24 High Efficacy requirements. Certified to California Appliance Efficiency Database under JA8.

BLD4 Housing Compatibility

BLD4 LED is rated for installation in 4" HALO and other housings.

HALO LED¹ H995ICAT, H995RICAT, H245ICAT, H245RICAT

HALO H99ICAT, H99RTAT, H99TAT, E4ICATSB, E4TATSB, E4RTATSB

Other Brands The BLD4 is UL Certified for use with any 4" diameter recessed housing constructed of steel or aluminum with an internal volume that exceeds 62.3 in³ in addition to those noted above.

1 HALO LED housings are non-screw base, high-efficacy code compliant.

H995ICAT

4" LED, IC, AIR-TITE,
New Construction Housing

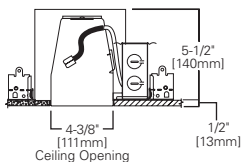

H995RICAT

4" LED, IC, AIR-TITE,
Remodel Housing

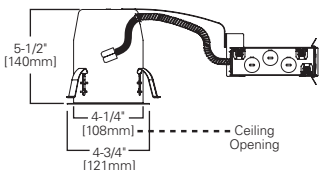

H245ICAT

4" LED, Ultra-shallow, IC, AIR-TITE, New Construction Housing

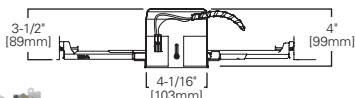
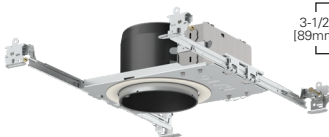

H245RICAT

4" LED, Ultra-shallow, IC, AIR-TITE, Remodel Housing

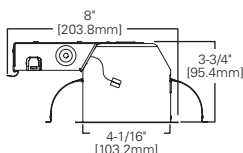

Friction clip install



BLD6 Housing Compatibility

BLD6 LED is rated for installation in 6" HALO and other housings.

HALO 6" LED¹	H750ICAT, H750RICAT, H750T, H750TCP, H2750ICAT, H2750RICAT, E750ICAT, E750RICAT
HALO 6"	H7ICAT, H7RICAT, H7ICT, H7RICT, H7ICATNB, H7ICTNB, H7T, H7RT, H7TNB, H7TCP, H7UICT, H7UICAT, H27ICAT, H27RICAT, H27T, H27RT, E7ICAT, E7RICAT, E27ICAT, E27RICAT, E7ICATNB, E7TAT, E7RTAT, E7TATNB, E27TAT, E27RTAT
HALO LED Retrofit	ML7BXRFK, ML7E26RFK
Other Brands*	The BLD6 is UL Certified for use with any 6" diameter recessed housing constructed of steel or aluminum with an internal volume that exceeds 107.9 in ³ in addition to those noted above.

*When using BLD6 torsion springs for retrofit some housings will not have torsion spring receiver brackets –use HALO ML7RAB retrofit adapter band (order separately)

1 HALO LED housings are non-screw base, high-efficacy code compliant.

H750ICAT

6" LED, IC, AIR-TITE, Standard New Construction Housing

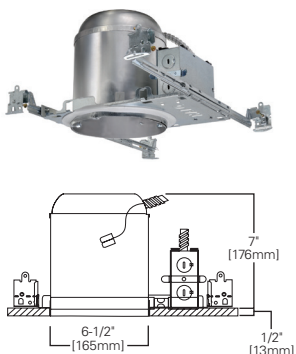

H2750ICAT

6" LED, IC, AIR-TITE, Shallow New Construction Housing

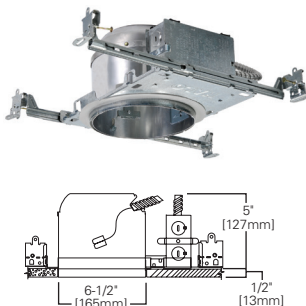

H750RICAT

6" LED, IC, AIR-TITE, Standard Remodel Housing

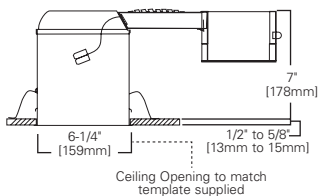









Friction clip install



Torsion spring install

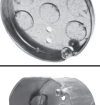
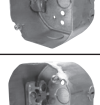

Compatible Junction Boxes*

		BLD4	BLD6
	Octagon - steel light fixture / fan box		
	4" x 4" x 2-1/8"	✓	✓
	4" x 4" x 1-1/2"		✓
	Square - steel deep box		
	4" x 4" x 2-1/8"		✓
	4" x 4" x 1-1/2"	✓	✓
	Round - new work fixture box (plastic)		
	4" diameter x 2-3/16"	✓	✓
	Round - new work ceiling box (plastic)		
	3-1/2" diameter x 2-3/4"	✓	✓
	Round - old work fixture box (plastic)		
	4" diameter x 2-3/16"	✓	✓
	Round - new work fixture box (plastic) with bar hanger		
	4" diameter x 2-3/16"	✓	✓
	Round surface mount		
	4" diameter x 1-1/2"	✓	✓
	Round ceiling pan**		
	4" diameter x 13/16"	✓	✓
	TP316 - Cooper Lighting Solutions' Crouse-Hinds junction box for non-metallic cable		
	4" x 2-1/8"	✓	✓
	TP317 - Cooper Lighting Solutions' Crouse-Hinds junction box for metal clad cable		
	4" x 2-1/8"	✓	✓

Junction box install



HALO HOME™



HALO Home In-wall Smart Dimmer

HIWMA1BLE40AWH

Controls standard lighting fixtures with dimmer or HALO Home mobile app. Features include:

- ON/OFF
- Dim
- Group
- Scene
- Schedule

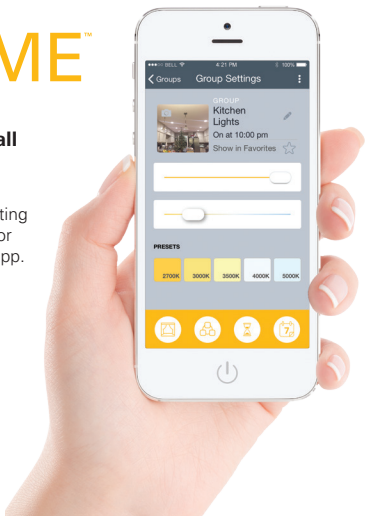

Cooper Lighting Solutions dimmers offer versatile options to set the mood and reduce energy consumption. These compatible LED dimmers are ideal for both residential and light commercial applications and are compatible with decorator (screwless) style devices and wallplates. Refer to www.cooperlighting.com for additional information.



Dimmer Features	Decorator (DAL06P)	Slide (SAL06P)	Toggle (TAL06P)
Rapid Start feature	Fully adjustable	Fixed ON	Fully adjustable
Adjustable high-end trim			
Adjustable low-end trim	•	•	•
Wiring configurations	Single-pole or three-way	Single-pole or three-way	Single-pole or three-way
Color change kits	•		•

**This is a representative list of compatible junction boxes only. Information contained in this literature about other manufacturers' products is from published information made available by the manufacturer and is deemed to be reliable, but has not been verified. Cooper Lighting Solutions makes no specific recommendation on product selection and there are no warranties of performance or compatibility implied. Installer must determine that site conditions are suitable to allow proper installation of the mounting bracket in the box.*

**** Only compatible with fixed CCT BLD406930 & BLD606930**

Product and Photometric Data

BLD406930WH

BLD4 3000K

BLD406930WH		
Luminaire lumens		690
Input watts		8.2
LER (LPW)		84.1
Spacing Criteria	0-180	1.26
	90-270	1.26
	Diagonal	1.38
Beam angle (degrees)		114.4
Field angle (degrees)		178.6
Max. Candela		222
Zonal lumen	Lumens	% Lumens
0-30	172	24.9%
0-40	282	40.8%
0-60	502	72.7%
0-90	690	100.00%

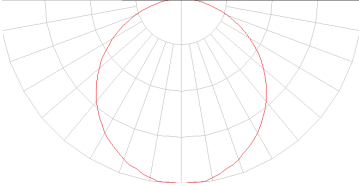

Color Metric Summary-3000K	
TM-30-15	Rf = 91
	Rg = 101.1
CRI/CIE	Ra = 93
	R9 = 75

CCT - Range of 2700K- 5000K



BLD4089SWH

BLD4 SeleCCTable

BLD4089SWH		
Luminaire lumens		802
Input watts		10.3
LER (LPW)		77.9
Spacing Criteria	0-180	1.28
	90-270	1.28
	Diagonal	1.4
Beam angle (degrees)		116.8
Field angle (degrees)		180
Max. Candela		250
Zonal lumen	Lumens	% Lumens
0-30	195	24.3%
0-40	321	40.0%
0-60	576	71.8%
0-90	802	100.00%

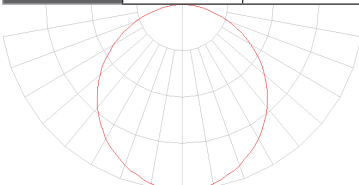

Color Metric Summary-3000K	
TM-30-15	Rf = 91.8
	Rg = 101.3
CRI/CIE	Ra = 93
	R9 = 70

CCT - Range of 2700K- 5000K



*Additional photometric ies files available online.

halolighting.com

BLD606930WH

BLD6 3000K

BLD606930WH		
Luminaire lumens	700	
Input watts	8.2	
LER (LPW)	85.4	
Spacing Criteria	0-180	1.26
	90-270	1.26
	Diagonal	1.38
Beam angle (degrees)	112.3	
Field angle (degrees)	170.2	
Max. Candela	235.8	
Zonal lumen	Lumens	% Lumens
0-30	182	26.0%
0-40	298	42.5%
0-60	527	75.3%
0-90	700	100.00%

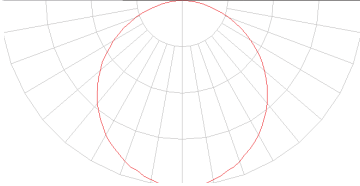

Color Metric Summary-3000K	
TM-30-15	Rf = 92.1
	Rg = 102
CRI/CIE	Ra = 93
	R9 = 77

CCT - Range of 2700K- 5000K



BLD6089SWH

BLD6 SeleCCTable

BLD6089SWH		
Luminaire lumens	812	
Input watts	10.3	
LER (LPW)	78.8	
Spacing Criteria	0-180	1.24
	90-270	1.24
	Diagonal	1.36
Beam angle (degrees)	108.5	
Field angle (degrees)	170.3	
Max. Candela	283.5	
Zonal lumen	Lumens	% Lumens
0-30	217	26.7%
0-40	352	43.4%
0-60	615	75.7%
0-90	812	100.00%

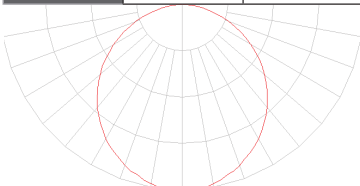

Color Metric Summary-3000K	
TM-30-15	Rf = 92.5
	Rg = 102
CRI/CIE	Ra = 93
	R9 = 76

CCT - Range of 2700K- 5000K



*Additional photometric ies files available online.

Cooper Lighting Solutions

1121 Highway 74 South
Peachtree City, GA 30269
P: 770-486-4800
www.cooperlighting.com

Canada Sales
5925 McLaughlin Road
Mississauga, Ontario L5R 1B8
P: 905-501-3000
F: 905-501-3172

Lighting Product Lines

Ametrix
AtLite
Corelite
Ephesus
Fail-Safe
HALO
HALO Commercial
Invue
io
IRIS
Lumark
Lumière
McGraw-Edison
Metalux
MWS
Neo-Ray
Portfolio
RSA
Shaper
Streetworks
Sure-Lites

Controls Product Lines

Greengate

Connected Lighting Systems

Fifth Light (Canada Only)
HALO Home
WaveLinX

IoT Platform

Trellix



© 2021 Cooper Lighting Solutions
All Rights Reserved
Printed in USA
Publication No. BR518055EN
May 2021

Products, specifications and compliances are subject to change without notice.

Cooper Lighting Solutions is a registered trademark.
All other trademarks are property of their respective owners.