

Project:	Type:	Prepared By:	Date:
-----------------	--------------	---------------------	--------------



Features and Benefits

- Produces rich and vibrant colors >90CRI
- Energy efficient replacement for incandescent and halogen PAR lamps
- Constructed from durable materials which lowers risk of breakage
- Rated for use in enclosed and open fixtures in dry and damp locations*
- Single optic and full face lens for precise beam angle control
- Longer lifespan compared to legacy equivalents minimizes replacement and maintenance costs
- Title 20 Compliant, UL Listed
- Dimmable down to 10% (check dimmer compatibility list)
- *PAR38 is wet rated

Technical Specifications		
<p>Performance</p> <p>Product Type: PAR</p> <p>Input Wattage: 11W</p> <p>Lumens (Nominal): 900lm</p> <p>Efficacy: 82lm/W</p> <p>L70 Lifespan: 25,000-Hour LED lifespan based on IES LM-70 results</p> <p>Wattage Equivalency: 75W</p> <p>LED Characteristics</p> <p>Color Accuracy (CRI): 90 CRI</p> <p>Color Temperature: 4000K</p>	<p>Electrical</p> <p>Power Factor: >0.9</p> <p>Dimmable: Yes, down to 10%</p> <p>Input Voltage: 120V</p> <p>Operating Temperature: -20°C to 40°C</p> <p>Construction</p> <p>Bulb Shape: PAR30L</p> <p>Enclosure Material: Plastic</p> <p>Housing Finish: White</p> <p>Base Type: E26 Edison</p>	<p>Optical</p> <p>Beam Angle: 35°</p> <p>MBCP: 1640</p> <p>Other</p> <p>Technology EQ: Halogen</p> <p>Warranty: RAB warrants that our LED products will be free from defects in materials and workmanship for a period of three (3) years from the date of delivery to the end user, including coverage of light output, color stability, driver performance and fixture finish. RAB's warranty is subject to all terms and conditions found at rablighting.com/warranty.</p> <p>Compliance</p> <p>UL Listed: Yes</p> <p>Environment/Fixture Rating: Damp / Enclosed</p>

Technical Specifications (continued)

T20 Compliant:

Yes, Title 20 Tier 2

T24 JA8 Compliant:

Complies with Title 24 Appendix JA8

Rohs:

Mercury and UV free. RoHS-compliant components.

FCC:

Complies with Part 15B of the FCC Rules

Model Number for Certification:

P10021(PAR30L-11-940-35D-DIM)

Case and Pallet Dimensions

	QTY	LENGTH (in)	WIDTH (in)	HEIGHT (in)
CASE	6	12.4	8.3	7
PALLET	576	45.5	37.2	35.4

Dimension

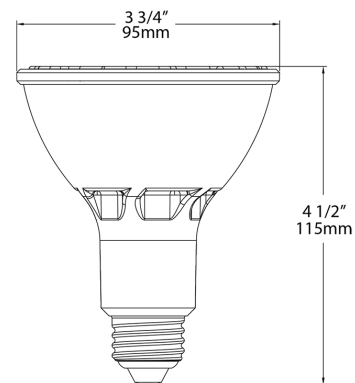

Light Distribution

